

Register your product and get support at

www.philips.com/welcome

Docking Entertainment System

AZD208



EN

User manual

PHILIPS

1 Important

Safety

Important Safety Instructions

- ① Read these instructions.
- ② Keep these instructions.
- ③ Heed all warnings.
- ④ Follow all instructions.
- ⑤ Do not use this apparatus near water.
- ⑥ Clean only with dry cloth.
- ⑦ Do not block any ventilation openings. Install in accordance with the manufacturer's instructions.
- ⑧ Do not install near any heat sources such as radiators, heat registers, stoves, or other apparatus (including amplifiers) that produce heat.
- ⑨ Protect the power cord from being walked on or pinched, particularly at plugs, convenience receptacles, and the point where they exit from the apparatus.
- ⑩ Only use attachments/accessories specified by the manufacturer.
- ⑪ Use only with the cart, stand, tripod, bracket, or table specified by the manufacturer or sold with the apparatus. When a cart is used, use caution when moving the cart/apparatus combination to avoid injury from tip-over.

- ⑫ Unplug this apparatus during lightning storms or when unused for long periods of time.
- ⑬ Refer all servicing to qualified service personnel. Servicing is required when the apparatus has been damaged in any way, such as power-supply cord or plug is damaged, liquid has been spilled or objects have fallen into the apparatus, the apparatus has been exposed to rain or moisture, does not operate normally, or has been dropped.
- ⑭ **Battery usage CAUTION** – To prevent battery leakage which may result in bodily injury, property damage, or damage to the unit:
- Install all batteries correctly, + and - as marked on the unit.
 - Do not mix batteries (old and new or carbon and alkaline, etc.).
 - Remove batteries when the unit is not used for a long time.
 - The batteries shall not be exposed to excessive heat such as sunshine, fire or the like.
- ⑮ Apparatus shall not be exposed to dripping or splashing.
- ⑯ Do not place any sources of danger on the apparatus (e.g. liquid filled objects, lighted candles).
- ⑰ This product may contain lead and mercury. Disposal of these materials may be regulated due to environmental considerations. For disposal or recycling information, please contact your local authorities or the Electronic Industries Alliance: www.eiae.org.

Important notes for users in the U.K.

How to connect a plug

The wires in the mains lead are coloured with the following code: blue = neutral (N), brown = live (L).

As these colours may not correspond with the colour markings identifying the terminals in your plug, proceed as follows:

- Connect the blue wire to the terminal marked N or coloured black.
- Connect the brown wire to the terminal marked L or coloured red.
- Do not connect either wire to the earth terminal in the plug, marked E (or e) or coloured green (or green and yellow).

Before replacing the plug cover, make certain that the cord grip is clamped over the sheath of the lead - not simply over the two wires.

- ① Remove fuse cover and fuse.
- ② Fix new fuse which should be a BS1362 3 Amp, A.S.T.A. or BSI approved type.
- ③ Refit the fuse cover.

If the fitted plug is not suitable for your socket outlets, it should be cut off and an appropriate plug fitted in its place.



Warning

- Never remove the casing of this apparatus.
- Never lubricate any part of this apparatus.
- Never place this apparatus on other electrical equipment.
- Keep this apparatus away from direct sunlight, naked flames or heat.
- Never look into the laser beam inside this apparatus.
- Ensure that you always have easy access to the power cord, plug or adaptor to disconnect this apparatus from the power.

- Where the MAINS plug or an appliance coupler is used as the disconnect device, the disconnect device shall remain readily operable.



Caution

- Use of controls or adjustments or performance of procedures other than herein may result in hazardous radiation exposure or other unsafe operation.

Notice



This product complies with the radio interference requirements of the European Community.

Any changes or modifications made to this device that are not expressly approved by Philips Consumer Lifestyle may void the user's authority to operate the equipment.

Recycling



Your product is designed and manufactured with high quality materials and components, which can be recycled and reused. When you see the crossed-out wheel bin symbol attached to a product, it means the product is covered by the European Directive 2002/96/EC:



Never dispose of your product with other household waste. Please inform yourself about the local rules on the separate collection of electrical and electronic products. The correct disposal of your old product helps prevent potentially negative consequences on the environment and human health.

Your product contains batteries covered by the European Directive 2006/66/EC, which cannot be disposed of with normal household waste. When you see the crossed-out wheel bin symbol with the chemical symbol 'Pb', it means that the batteries comply with the requirement set by the directive for lead:

Please inform yourself about the local rules on separate collection of batteries. The correct disposal of batteries helps prevent potentially negative consequences on the environment and human health.

Recording and playback of material might require consent. See Copyright Act 1956 and The Performer's Protection Acts 1958 to 1972.

Environmental information

All unnecessary packaging has been omitted. We have tried to make the packaging easy to separate into three materials: cardboard (box), paper pulp (buffer) and polyethylene (bags, protective foam sheet.) Your system consists of materials which can be recycled and reused if disassembled by a specialized company. Please observe the local regulations regarding the disposal of packaging materials, exhausted batteries and old equipment.

This apparatus includes these labels:



Class II equipment symbol



This symbol indicates that the apparatus has a double insulation system.

2 Your CD Soundmachine

Introduction

With this CD Soundmachine, you can:

- play audio discs
- listen to FM/MW radio
- enjoy music from iPod and other external devices
- program the play sequence of tracks

Dynamic Bass Boost (DBB) helps you to maximize music enjoyment.

What's in the box

Check and identify the contents of the package:

- Main unit
- AC power cord
- User Manual
- Quick Start Guide

Overview of the main unit

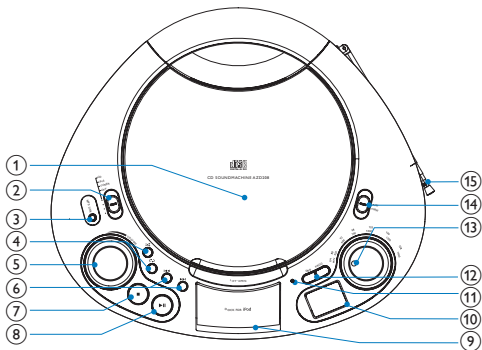

① LIFT-OPEN

- Open/close the disc compartment.

② Source selector

- Select a source: CD, iPod, or tuner.
- Turn off the unit.

③ MP3 LINK

- Jack for an external audio device.

④

- Play track/twotracks randomly.



- Play track/tracks repeatedly.

⑤ **VOLUME**

- Adjust volume.

⑥ **⏮⏪⏩⏭**

- Skip to the previous/next track.
- Search within a track.

⑦ **■**

- Stop play.

⑧ **▶||**

- Start or pause play.

⑨ **DOCK FOR iPod**

⑩ **Display panel**

- Display current status.

⑪ **DBB Indicator**

⑫ **PROG**

- Program CD tracks and browse the program.

DBB

- Turn on/off dynamic bass boost.

⑬ **Tuning button**

- Tune to a FM/MW radio station.

⑭ **FM/MW**

- Select FM/MW source.

⑮ **Antennaw**

3 Get started



Caution

- Use of controls or adjustments or performance of procedures other than herein may result in hazardous radiation exposure or other unsafe operation.

Always follow the instructions in this chapter in sequence. If you contact Philips, you will be asked for the model and serial number of this apparatus. The model number and serial number are on the bottom of the apparatus. Write the numbers here:

Model No. _____

Serial No. _____

Install batteries



Note

- You can use both batteries and AC power as power supply of this apparatus.
- Batteries are not supplied with the accessories.

- 1 Open the battery compartment.
- 2 Insert 6 batteries (type: R14/ UM2/ C-cells) with correct polarity (+/-) as indicated.

- 3 Close the battery compartment.

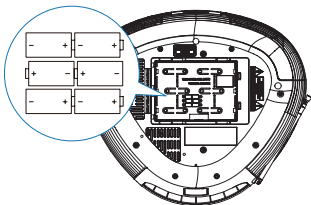

Connect power



Warning

- Risk of product damage! Ensure that the power supply voltage corresponds to the voltage printed on the back or the underside of the apparatus.
- Risk of electric shock! When you disconnect the AC power, always pull the plug from the socket. Never pull the cord.



Note

- Install the apparatus near the power supply socket and where the power plug can be easily reached.

- 1 Connect the power cord to:
 - the AC MAINS jack on the unit
 - the power supply socket.

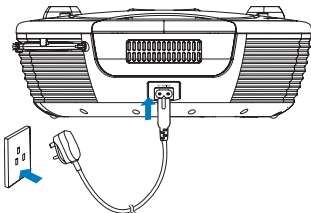

Tip

- To switch the apparatus off completely, disconnect the power cord from the power supply socket.

Note

- To save energy: after use, turn off the apparatus.

Turn on

- 1 Push the source selector to **CD**, **iPod**, or **TUNER**.

Turn off

- 1 Push the source selector to **OFF**.

4 Play

Play disc

- 1 Push the source selector to **CD**.
 - 2 Lift to open the disc compartment.
 - 3 Insert a disc with the printed side facing up, then close the disc compartment.
 - 4 Press **▶ ||** to start play.
 - To pause/resume play, press **▶ ||**.
 - To stop play, press **■**.
 - To select another track, press **◀◀▶▶**.
 - To search within a track, press and hold **◀◀▶▶**, then release to resume normal play.
-

Play from iPod

You can enjoy audio from iPod through this unit.

Compatible iPod

Apple iPod models with a 30-pin dock connector:

- iPod classic, iPod touch, iPod nano, iPod 5th generation (video), iPod with color display, iPod mini.

Play an iPod player

- 1 Lift to open the dock for iPod.

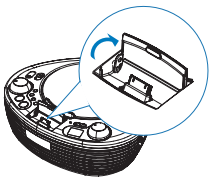

- 2 Place the iPod player in the dock.

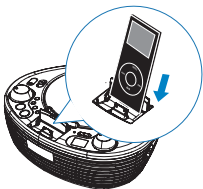

- 3 Push the source selector to iPod.
- To pause/resume play, press ►||.
 - To skip to a track, press |◀◀▶▶|.
 - To search during play, press and hold |◀◀▶▶|, then release to resume normal play.

Charge the iPod

When **iPod**, **TUNER**, or **MP3 LINK** source is selected, the docked iPod begins to charge.

Listen to the radio

Tune to a radio station

- 1 Push the source selector to **TUNER**.
- 2 Push the band selector to **FM** or **MW**.
- 3 Turn **TUNING** to tune to a station.



Tip

- Position the antenna as far as possible from TV, VCR or other radiation source.
- For optimal reception, fully extend and adjust the position of the antenna.

Listen to an external device

You can listen to an MP3 player through this apparatus.



Note

- When you connect an external device to **MP3 LINK** jack, the apparatus switches to **MP3 LINK** source automatically.

- 1 Use a 3.5mm plugs cable (not supplied) on both ends to connect MP3 LINK jack (3.5mm) on this apparatus and the headphone jack on an MP3 player.

5 Play options

Adjust volume

- 1 During play, turn **VOLUME** to increase/decrease the volume level.
-

Enhance bass

- 1 Press **DBB** repeatedly to turn on/off dynamic bass enhancement.
 - ↳ When **DBB** is activated, the **DBB** indicator turns blue.
-

Select play modes

Repeat

- 1 Press  to play the current track or all tracks repeatedly.
- **[REP]** (repeat) – repeat a track.
 - **[REP ALL]**(repeat all) - repeat an entire CD/program.

Shuffle

- 1 Press  to play all tracks randomly.
- **[SHUFFLE]** (shuffle) - play tracks randomly.
-

Program tracks

You can program a maximum of 20 tracks.

- 1 In **CD** mode, at the stop position, press **PROGRAM** to activate the program mode.
- 2 Press  to select a track number, then press **PROGRAM** to confirm.

- 3 Repeat steps 2 to 3 to program more tracks.
 - 4 Press ►|| to play the programmed tracks.
 - ↳ During play, [PROG] (program) is displayed.
- To erase the program, press ■ .
 - To review the program, in the stop position, press **PROGRAM**.

6 Product information



Note

- Product information is subject to change without prior notice.

Specifications

Disc

| | |
|---------------------------|--------------------|
| Laser Type | Semiconductor |
| Disc Diameter | 12cm/8cm |
| Support Disc | CD-DA, CD-R, CD-RW |
| Audio DAC | 24Bits / 44.1kHz |
| Total Harmonic Distortion | <1% |
| Frequency Response | 60Hz -16kHz |
| S/N Ratio | >62dBA |

Tuner

| | |
|---------------------------|---|
| Tuning Range | FM: 87.5 - 108MHz; MW: 530 - 1600kHz |
| Total Harmonic Distortion | <3% |
| Signal to Noise Ratio | >50 dB |

General

| | |
|------------------------------------|---|
| Power supply | AC: 220 - 240V, 50/60 Hz DC: 9V, 1.5 x 6 R14/UM2 |
| Operation Power Consumption | 15 W |
| Standby Power Consumption | < 1 W |
| Dimensions - Main Unit (W x H x D) | 297 x 112 x 264 mm |
| Weight | 1.7 kg |

Maintenance

Clean the cabinet

- Use a soft cloth slightly moistened with a mild detergent solution. Do not use a solution containing alcohol, spirits, ammonia or abrasives.

Clean discs

- When a disc becomes dirty, clean it with a cleaning cloth. Wipe the disc from the centre out.
- Do not use solvents such as benzene, thinner, commercially available cleaners, or antistatic spray intended for analogue records.

Clean the disc lens

- After prolonged use, dirt or dust may accumulate at the disc lens. To ensure good play quality, clean the disc lens with Philips CD lens cleaner or any commercially available cleaner. Follow the instructions supplied with cleaner.

7 Troubleshooting



Warning

- Never remove the casing of this apparatus.

To keep the warranty valid, never try to repair the system yourself.

If you encounter problems when using this apparatus, check the following points before requesting service. If the problem remains unsolved, go to the Philips web site (www.philips.com/welcome).

When you contact Philips, ensure that the apparatus is nearby and the model number and serial number are available.

No power

- Ensure that the AC power plug of the unit is connected properly.
- Ensure that there is power at the AC outlet.
- Insert the batteries with their polarities (+/- signs) aligned as indicated.
- Replace the battery.

No sound

- Adjust the volume.

No response from the unit

- Take out the batteries and turn on the unit again.
- Disconnect and reconnect the AC power plug, then turn on the unit again.

No disc detected

- Insert a disc.
- Check if the disc is inserted upside down.
- Wait until the moisture condensation at the lens has cleared.
- Replace or clean the disc.
- Use a finalized CD or correct format disc.

Poor radio reception

- Increase the distance between the unit and your TV or VCR.
- Fully extend the FM antenna.
- Connect an outdoor FM antenna instead.

Meet Philips at the Internet
www.philips.com/welcome



© Royal Philips Electronics N.V. 2010
All rights reserved.

Specifications are subject to change
without notice. Trademarks are
the property of Koninklijke Philips
Electronics N.V. or their respective
owners.

Printed in China
AZD208_05_UM_V1.1

