

Register your product and get support at
www.philips.com/welcome

CED780



User manual

PHILIPS

Contents

1 Important	5	7 Play with Bluetooth device	26
Safety	5	Pair the Bluetooth-enabled devices	26
Notice	5	Make a call	27
		Receive call	27
2 Your in-car entertainment system	7	Bluetooth phone book settings	28
Introduction	7	Favorite call	28
What's in the box	7	Adjust Bluetooth settings	28
Overview of the main unit	9	Listen to music from Bluetooth device	29
Overview of the remote control	10		
		8 Play iPod/iPhone	29
3 Get started	12	Compatible iPod/iPhone	29
Install the car audio	12	Listen to the iPod/iPhone	29
Mount into the dashboard	15	Search for a track	30
Attach the front panel	16	Charge the iPod/iPhone	30
Install remote control battery	16		
Turn on	17	9 Adjust sound	31
Set date and time	17	Adjust volume	31
		Mute	31
		Select preset equalizer	31
4 Play audio/video/picture	18	Adjust fader/balance/subwoofer	31
Load discs	18	Switch music listening zone	32
Connect USB device	19	Turn FullSound on/off	32
Insert SD card	19	Turn MAX sound on/off	33
Play/Pause	20	Turn DBB on/off	33
Browse	20		
Select audio track	20	10 Adjust settings	33
Select subtitle language	20	Display system setup menu	33
Change view angle	20	Adjust general settings	33
Repeat one/all chapter	21	View Info settings	34
Random play	21	Adjust Navigation settings	34
Select audio mode	21	Adjust Bluetooth settings	35
View photo	21		
		11 Others	36
5 Listen to radio	22	Adjust brightness	36
Tune to a radio station	22	Set rear view camera	36
Store radio stations in memory	23	Adjust display design	36
Tune to a preset station	23	Listen to other devices	36
Play with RDS (Optional)	23	Detach the front panel	37
		Reset	37
6 Use navigation system	25	Replace fuse	37
Insert map card	25		
Use map	25		

12 Product information	38
USB playability information	39

13 Troubleshooting	40
About the Bluetooth device	40

1 Important

Safety

- Read and understand all instructions before you use the device. If damage is caused by failure to follow instructions, the warranty does not apply.
- Use of controls or adjustments or performance of procedures other than herein may result in hazardous radiation exposure or other unsafe operation.
- The device is designed for negative ground (earth) 12V DC operation only.
- To reduce the risk of traffic accidents, do not watch video when driving.
- To ensure safe driving, adjust the volume to a safe and comfortable level.
- Improper fuses can cause damage or fire. When you need to change the fuse, consult a professional.
- Use only the supplied mounting hardware for a safe and secure installation.
- To avoid short circuits, do not expose the device, remote control or remote control batteries to rain or water.
- The device shall not be exposed to dripping or splashing.
- Do not place any sources of danger on the device (e.g. liquid filled objects, lighted candles).
- Never insert objects into the ventilation slots or other openings on the device.
- Never place any objects other than discs into the disc tray/slot.
- To avoid exposure to laser radiation, do not disassemble the device.
- Risk of damage to the screen! Never touch, push, rub or strike the screen with any object.
- Never use solvents such as benzene, thinner, cleaners available commercially, or anti-static sprays intended for discs.

- Clean the device with soft, damp cloth. Never use substances such as alcohol, chemicals or household cleaners on the device.

Notice



The making of unauthorized copies of copy-protected material, including computer programs, files, broadcasts and sound recordings, may be an infringement of copyrights and constitute a criminal offence. This equipment should not be used for such purposes.

The Bluetooth® word mark and logos are registered trademarks owned by Bluetooth SIG, Inc. and any use of such marks by Philips is under license.



Windows Media and the Windows logo are trademarks, or registered trademarks of Microsoft Corporation in the United States and/or other countries.



“Made for iPod” and “Made for iPhone” mean that an electronic accessory has been designed to connect specifically to iPod or iPhone respectively, and has been certified by the developer to meet Apple performance standards. Apple is not responsible for the operation of this device or its compliance with safety and regulatory standards. Please note that the use of this accessory with iPod or iPhone may affect wireless performance. iPod and iPhone are trademarks of Apple Inc., registered in the U.S. and other countries.



ABOUT DIVX VIDEO: DivX® is a digital video format created by DivX, LLC, a subsidiary of Rovi Corporation. This is an official DivX Certified® device that plays DivX video. Visit divx.com for more information and software tools to convert your files into DivX videos.

ABOUT DIVX VIDEO-ON-DEMAND: This DivX Certified® device must be registered in order to play purchased DivX Video-on-Demand (VOD) movies. To obtain your registration code, locate the DivX VOD section in your device setup menu. Go to vod.divx.com for more information on how to complete your registration.

DivX®, DivX Certified® and associated logos are trademarks of Rovi Corporation or its subsidiaries and are used under license.



Manufactured under license from Dolby Laboratories.

"Dolby" and the double-D symbol are trademarks of Dolby Laboratories.

Other trademarks and trade names are those of their respective owners.

This apparatus includes this label:



Environmental information

All unnecessary packaging has been omitted. We have tried to make the packaging easy to separate into three materials: cardboard (box), polystyrene foam (buffer) and polyethylene (bags, protective foam sheet.)

Your system consists of materials which can be recycled and reused if disassembled by a specialized company. Please observe the local regulations regarding the disposal of

packaging materials, exhausted batteries and old equipment.

Recycling



Your product is designed and manufactured with high quality materials and components, which can be recycled and reused.

When you see the crossed-out wheel bin symbol attached to a product, it means the product is covered by the European Directive 2002/96/EC:



Never dispose of your product with other household waste. Please inform yourself about the local rules on the separate collection of electrical and electronic products. The correct disposal of your old product helps prevent potentially negative consequences on the environment and human health.

Your product contains batteries covered by the European Directive 2006/66/EC, which cannot be disposed of with normal household waste. Please inform yourself about the local rules on separate collection of batteries. The correct disposal of batteries helps prevent potentially negative consequences on the environment and human health.



This product complies with the radio interference requirements of the European Community.

Disposal of your old product and batteries

Your product is designed and manufactured with high quality materials and components, which can be recycled and reused.

Never dispose of your product with other household waste. Please inform yourself about the local rules on the separate collection of electrical and electronic products and batteries. The correct disposal of these products helps prevent potentially negative consequences on the environment and human health.

Your product contains batteries, which cannot be disposed of with normal household waste. Please inform yourself about the local rules on separate collection of batteries. The correct disposal of batteries helps prevent potentially negative consequences on the environment and human health.

Please visit www.recycle.philips.com for additional information on a recycling center in your area.

Any changes or modifications made to this device that are not expressly approved by Philips Consumer Lifestyle may void the user's authority to operate the equipment.

Copyright

2012 © Koninklijke Philips Electronics N.V. Specifications are subject to change without notice. Trademarks are the property of Koninklijke Philips Electronics N.V or their respective owners. Philips reserves the right to change products at any time without being obliged to adjust earlier supplies accordingly.

2 Your in-car entertainment system

Congratulations on your purchase, and welcome to Philips! To fully benefit from the support that Philips offers, register your product at www.philips.com/welcome.

Introduction

With the car entertainment system, you can

- Quickly found routine through the navigation system

And you can also enjoy:

- Audio/video/JPEG pictures from
 - DVD, VCD or CD
 - USB devices
 - SD/SDHC/MMC cards
 - iPod/iPhone
 - External devices
- FM or AM (MW) radio
- Audio from Bluetooth-enabled devices

Besides, you can make/receive phone calls with Bluetooth-enabled devices.

What's in the box

Check and identify the contents of your package:

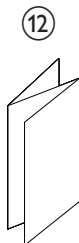
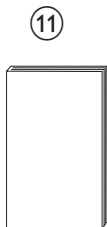
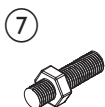
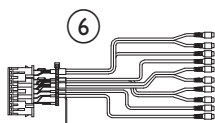
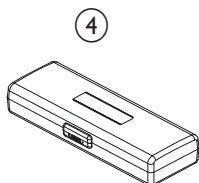
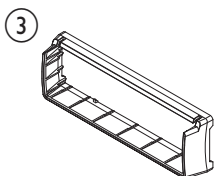
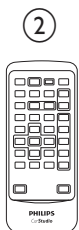
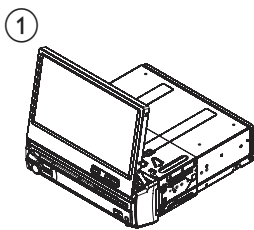

- ⑨ Remote control battery
- ⑩ Rubber cushion
- ⑪ User manual
- ⑫ Quick start guide

- ① Main unit and front panel (with a sleeve)
- ② Remote control
- ③ Trim plate
- ④ Carrying case for front panel
- ⑤ ISO standard connector
- ⑥ Audio and Video cable
- ⑦ Hexagon head screw
- ⑧ Screws
- M4x8mm (x4)

Overview of the main unit

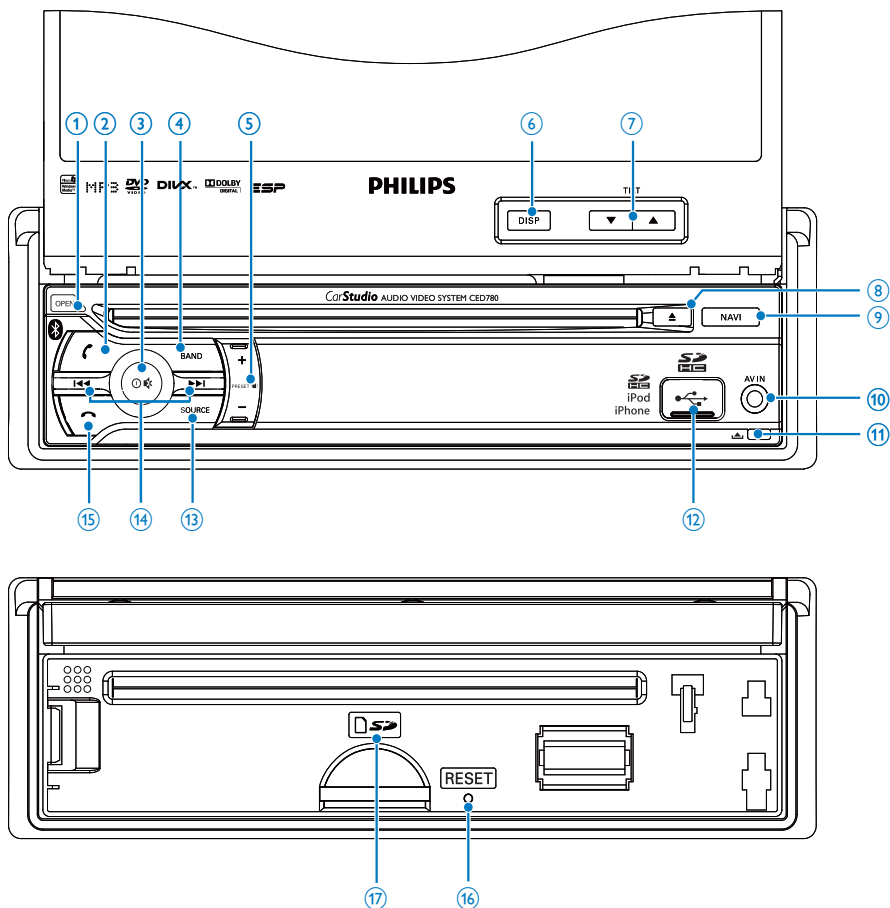

- | | |
|--|--|
| <p>① OPEN</p> <ul style="list-style-type: none"> • Open/Close TFT screen. <p>② ☎</p> <ul style="list-style-type: none"> • Press to answer a call. • Press and hold to transfer call. <p>③ ⓪ / 🔇</p> <ul style="list-style-type: none"> • Turn the unit on or off. • Mute or unmute sound. • Rotate to adjust volume. <p>④ BAND</p> <ul style="list-style-type: none"> • Select tuner band. <p>⑤ +/-PRESET </p> | <ul style="list-style-type: none"> • Select preset radio station. • Search for track/folder. <p>⑥ DISP</p> <ul style="list-style-type: none"> • Adjust dimmer settings. • Press and hold to turn off TFT display. <p>⑦ ▲ TILT ▼</p> <ul style="list-style-type: none"> • Adjust position of the screen. <p>⑧ ▲</p> <ul style="list-style-type: none"> • Eject disc. <p>⑨ NAVI</p> <ul style="list-style-type: none"> • Enter GPS navigation system. <p>⑩ AV IN</p> |
|--|--|

- External audio/video socket.

⑪ 

- Unlock the panel.

⑫ 

- USB socket.

⑬ **SOURCE**

- Select source.

⑭ 

- Press to terminate call.

⑮ 

- Tune for radio station.
- Skip/search for track.
- Fast backward/forward playback.

⑯ **RESET**

- Reset the unit when it hangs up.

⑰ **SD/SDHC card slot**

Overview of the remote control

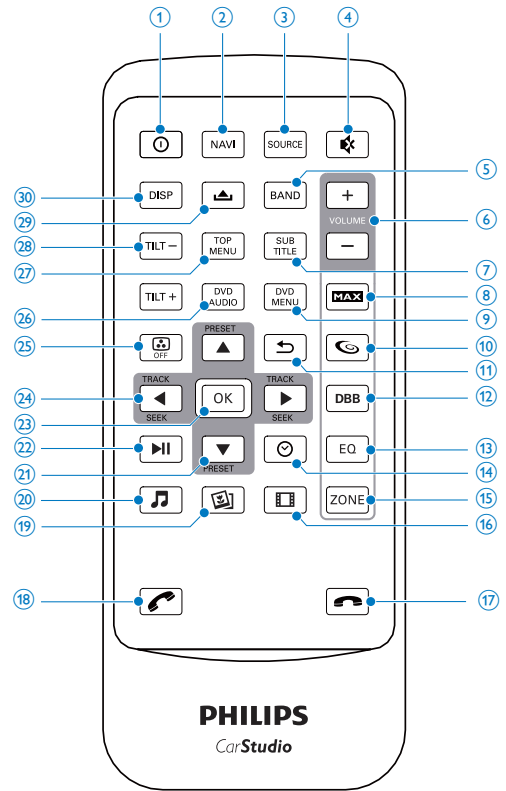

① 

- Turn the unit on or off.

② **NAVI**

- Enter GPS navigation system.

③ **SOURCE**

- Select source.

④ 

- Mute or unmute sound.

⑤ **BAND**













- Select tuner band.

⑥ **VOLUME +/-**

- Adjust volume.

⑦ **SUBTITLE**

- Select DVD or DivX subtitle language.

- 8 **MAX**
- Turn maximizing sound on or off.
- 9 **DVD MENU**
- Access DVD main menu.
- 10 
- Turn full sound on or off.
- 11 
- Return to previous menu or exit.
- 12 **DBB**
- Turn Dynamic Bass Boost (DBB) sound on or off.
- 13 **EQ**
- Access audio setting menu.
- 14 
- View the clock.
- 15 **ZONE**
- Switch music listening zone.
- 16 
- Select video channel.
- 17 
- Answer phone.
 - Dial or redial number.
- 18 
- Terminate call.
- 19 
- Browse photos.
- 20 
- Switch to music playing mode.
- 21 
- Skip to previous/next preset station.
 - Skip to previous/next folder.
 - Search backward/forward for DVD video.
 - Move cursor up/down.
- 22 
- Start play or pause.
- 23 **OK**
- Confirm selection.
- 24 
- Skip to previous/next track/chapter.
 - Move cursor to left/right.
- 25 
- Turn TFT on or off.
- 26 **DVD AUDIO**
- Select audio language or audio channel.
- 27 **TOP MENU**
- Return to top menu.
- 28 **TILT +/-**
- Adjust position of the screen.
- 29 
- Unlock the panel.
- 30 **DISP**
- Adjust dimmer settings.
 - Press and hold to turn off TFT display.

3 Get started

! Caution

- Use of controls or adjustments or performance of procedures other than herein may result in hazardous radiation exposure or other unsafe operation.

Always follow the instructions in this chapter in sequence.

Install the car audio

These instructions are for a typical installation. However, if your car has different requirements, make the corresponding adjustment. If you have any questions regarding installation kits, consult your Philips car audio dealer.

! Caution

- This unit is designed for negative ground (earth) 12V DC operation only.
- Always install this unit in the car dashboard. Other locations can be dangerous as the rear of the unit heats up during use.
- To avoid short-circuit: before you connect, ensure that the ignition is off.
- Ensure that you connect the yellow and red power supply leads after all other leads are connected.
- Ensure that all loose leads are insulated with electrical tape.
- Ensure that the leads do not get caught under screws or in moving parts (e.g. seat rail).
- Ensure that all ground (earth) leads are connected to a common ground (earth) point.
- Use only the supplied mounting hardware for a safe and secure installation.
- Improper fuses can cause damage or fire. When you need to change the fuse, consult a professional.

Note on the power supply lead (yellow)

- When you connect other devices to this system, ensure that the rating of the car circuit is higher than the total fuse value of all the connected devices.

Notes on speaker connection

- Never connect speaker wires to the metal body or chassis of the car.
- Never connect speaker wires with stripes to one another.

Connect wires

! Caution

- Ensure that all loose leads are insulated with electrical tape.

- 1 Check the car's wiring carefully, then connect them to the supplied ISO wires.

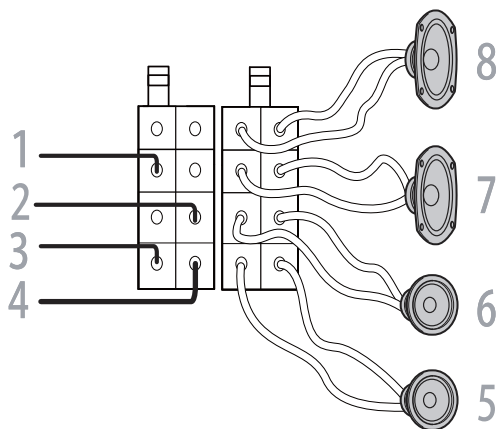

Connector	Connect to
1 Yellow wire	The +12V car battery which is live at all times.
2 Blue/White wire	The electric antenna control lead or power supply lead of the antenna booster. If there is no electric antenna or antenna booster, or it is manually operated telescopic antenna, it is unnecessary to connect this lead.
3 Black wire	A metal surface of the car. Connect the black ground (earth) lead before connect the yellow and red power supply leads.

Connector	Connect to
4 Red wire	The +12V power terminal which is live in the accessory (ACC) position of the ignition switch. If there is no accessory position, connect to the +12V car battery terminal that is always live. Ensure that black ground (earth) lead is connected to a metal surface of the car first.
5 Green and green/black wires	Left speaker (Rear)
6 White and white/black wires	Left speaker (Front)
7 Gray and gray/black wires	Right speaker (Front)
8 Purple and purple/black wires	Right speaker (Rear)

- 2 Connect the other end of the supplied standard connector to the car audio system.



Caution

- To avoid any accident, the driver must not watch video while driving. This unit is designed to not allow watching moving video while driving. Park your car in a safe place and engage the parking brake before watching moving video.



Note

- The video blocking system under parking brake not engaged only control the display of this unit, and will not affect the video output through the rear RCA video output.
- If watch moving video from disc or AV-IN source but parking brake is not properly connected, the video signal will be blocked by the system, and the below display will be shown on TFT:



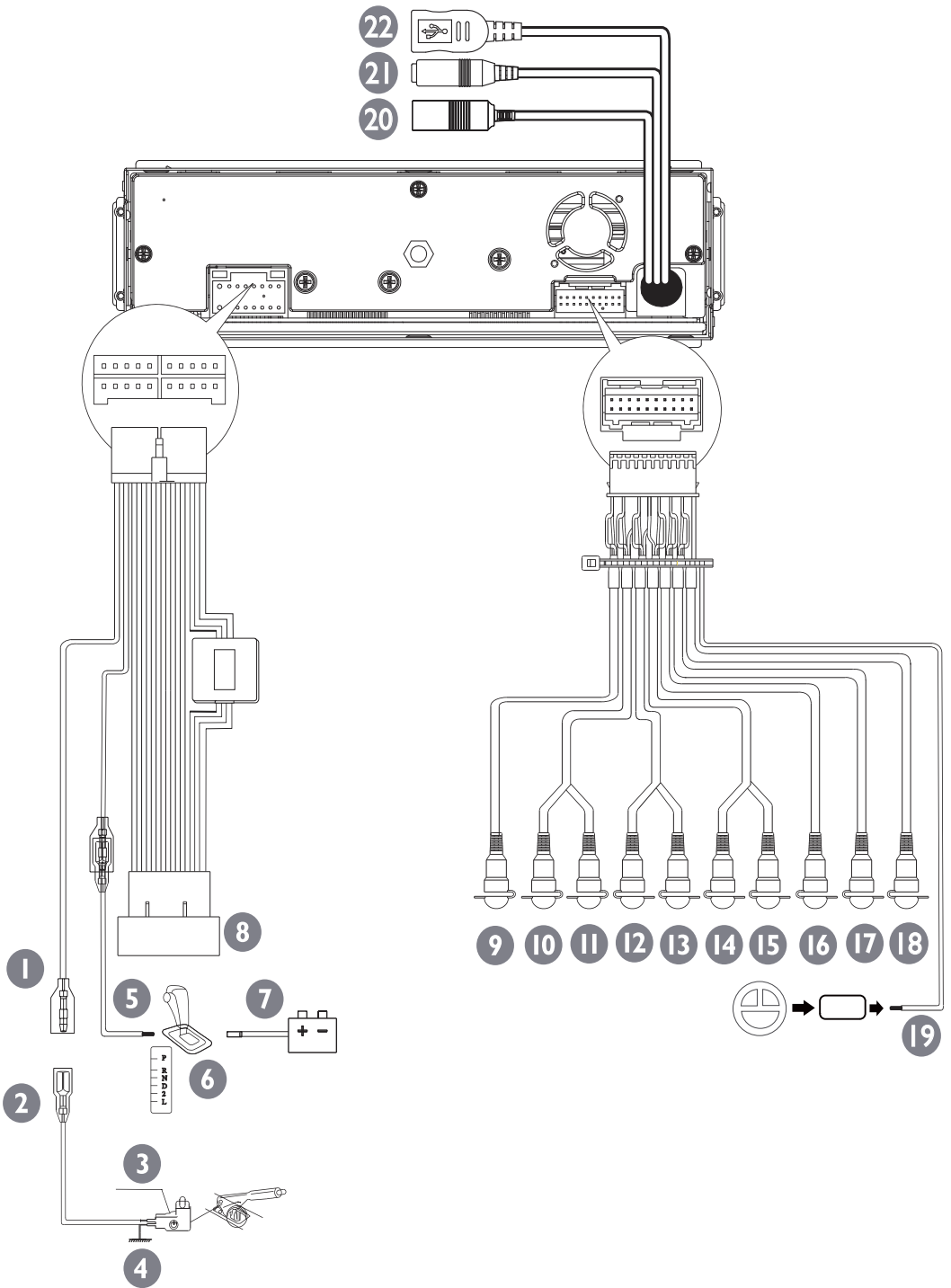

	Connector/Object	Connect to/with
1	Pink wire	Extension wire
2	Extension wire (not included)	Parking brake (-)
3	Brake switch	
4	Ground	
5	Purple wire	Reverse camera (B+)
6	Gearbox switch	
7	Reverse gear signal	Black lamp lead +
8	ISO wires	Connected in step 1 above
9	Yellow cable	Video out
10	Red cable	Rear line out (Right)
11	White cable	Rear line out (Left)
12	Red cable	Front line out (Right)
13	White cable	Front line out (Left)
14	Red cable	Audio in (Right)
15	White cable	Audio in (Left)
16	Yellow cable	Video in
17	Brown cable	Camera in
18	Blue cable	Subwoofer
19	White wire	OE remote
20	Black wire	Radio antenna
21	Black wire	External microphone
22	Black wire	GPS smart antenna

Mount into the dashboard

Note

- Check wire connection before you mount the unit into a car.
- If preset radio stations are lost when the ignition key is turned off and then turned on, reconnect the red leads crosswise to the yellow ones.

- 1 If the car does not have an on-board drive or navigation computer, disconnect the negative terminal of the car battery.
 - If you disconnect the car battery in a car that has an on-board drive or navigation computer, the computer may lose its memory.

- If the car battery is not disconnected, to avoid short-circuit, ensure that the bare wires do not touch each other.

- 2 Ensure that car dashboard opening is within these measurements:

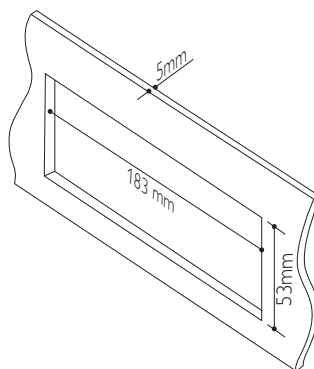

- Since the unit cannot be used if the slant angle of dashboard opening is above 20 degrees, ensure that the horizontal slant of the dashboard opening is between 0 and 20 degrees.

- 3 When installing in a shallow space, change the position of slide brackets.

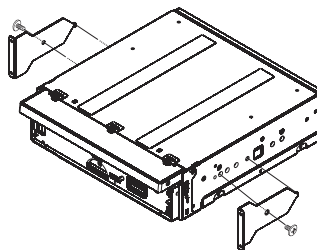

- 4 Place the supplied rubber cushion over the end of the mounting bolt.

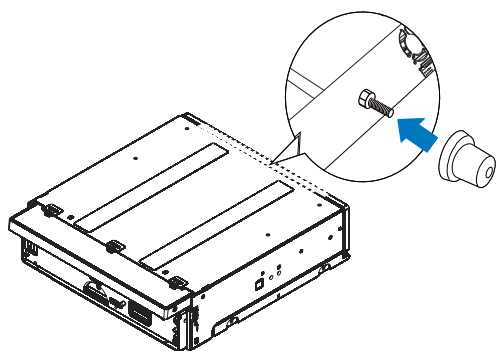

- 5 Install the sleeve into the dashboard and bend the tabs outwards to fix the sleeve. Slide the unit into the dashboard until you hear a click.

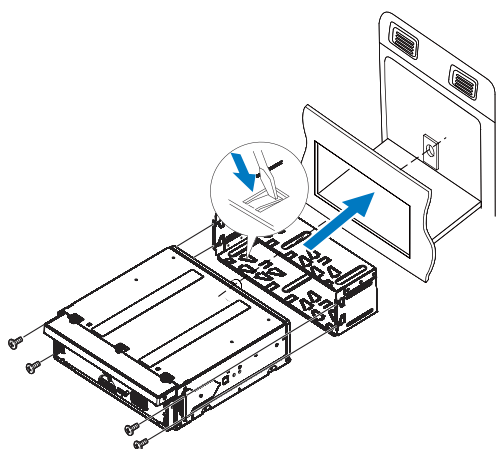

Note

- If the unit is fixed by the supplied screws instead of the sleeve, skip this step.

Attach the front panel

- 1 Attach the trim plate.

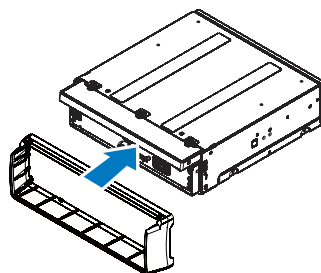

- 2 Insert the left side of the panel in the chassis until it is correctly engaged.

- 3 Press the right side of the panel until the mechanism locks it into place.

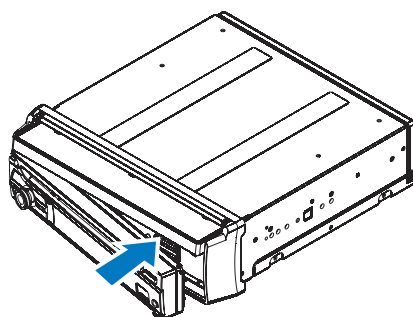

Install remote control battery

Caution

- Risk of explosion! Keep battery away from heat, sunshine or fire. Never discard battery in fire.

Note

- Remove battery if it is flat or if the remote control will not be used for a long time.
- Battery contain chemical substances. It should be disposed of properly.

- 1 Open the battery compartment.

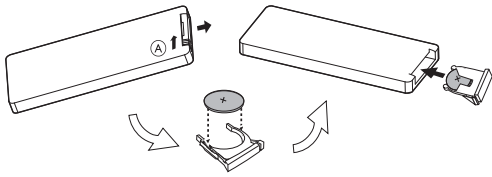

- 2 Insert one CR2025 battery with correct polarity (+/-) as indicated.
- 3 Close the battery compartment.

Turn on



Caution

- Risk of road accidents! Never watch videos or adjust settings while you drive.

- 1 Press  to turn the unit on.
↳ The available OSD (On-Screen Display) languages are displayed.
- 2 Tap a language with fingertip.
↳ The OSD language is changed to the selected language immediately.



- 3 Tap a radio region with fingertip.
↳ The radio region is changed to the selected radio region immediately.



- 4 Tap **[Finish]** to confirm.



Set date and time

- 1 Tap  to display main menu.



2 Tap ▲ to display the full menu.



3 Tap ⚙️.
↳ The setup menu is displayed.



4 Drag the bar downward with fingertip.
↳ The date/time setup menu is displayed.



5 Tap on [Clock Mode], [Date] or [Time].

6 Tap ▲ or ▼ to set date/time.

7 When date/time is set, tap ↵ to return to main menu.

4 Play audio/ video/picture

Load discs

You can play video, audio or images stored on the following discs:

- DVD video, DVD-R, DVD-RW
- VCD
- Audio CD, CD-R, CD-RW

1 Insert the disc into the disc slot with label side facing up.

↳ The disc starts playing automatically.

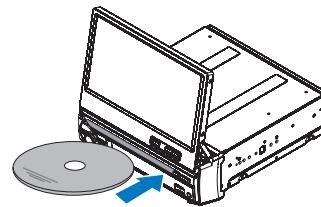





2 To remove the disc, press the ▲ button.

↳ When the disc is ejected, the unit switches to the previous source, if connected. Otherwise, the unit switches to [Radio] mode automatically.

Note

- Supported region code depends on where you bought the car audio system.

Countries where you bought the unit	Supported DVD region code
China	
Asia Pacific, Taiwan, Korea	
Latin America	
Russia, India	

Connect USB device

Note

- Ensure that the device contains playable content.

- 1 Push the USB socket cover upside.
- 2 Insert the USB device into the USB slot.
↳ The files play automatically.

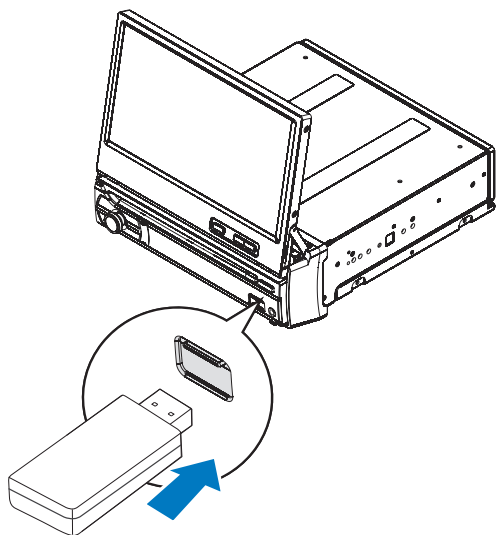

- 3 To remove the USB device, switch the car audio system to other source first, then take off the USB device.
↳ When USB device is disconnected, it plays the previous source.

Insert SD card

Note

- This device supports Secure Digital High Capacity (SDHC) card.

- 1 Detach the front panel. (see 'Detach the front panel' on page 38)
- 2 Insert the SD card into SD card slot.
↳ Play starts automatically.

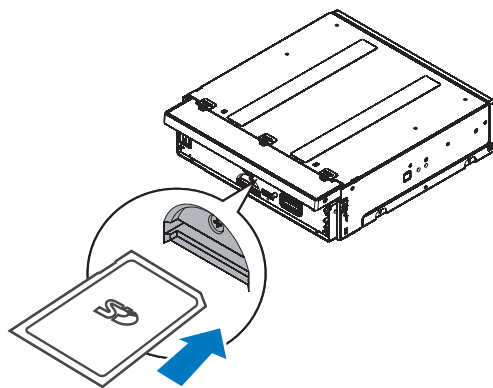

Remove SD card

- 1 Switch to another source.
- 2 Press the card until you hear a click.
↳ The card is now disengaged.
- 3 Remove the SD card.

Play/Pause



- 1 To pause, tap **⏸**.
 - To resume play, tap **⏸** again.
- 2 To skip forward/backward, tap **⏮** / **⏭**.

Browse

During play from USB device or SD card, you can browse through the listed audio/video or picture files to select preferred file for listening or watching.

- 1 Tap **☰** or **⏮** to return to playlist menu.
- 2 Tap one of the icons below to select folder/file:
 - **🎵**: to display all available audio folders/tracks.
 - **🖼️**: to display all available picture folders/files.
 - **📺**: to display all available video folders/files.

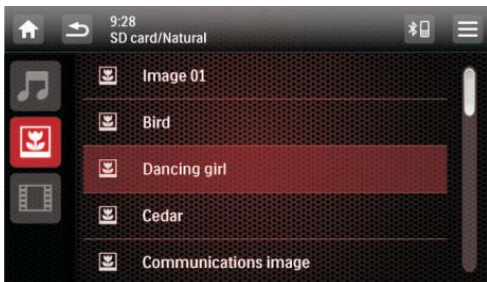

- 3 Drag the bar downward with fingertip to view the list.

- 4 Tap on the name to start play.

Select audio track

For video discs that contain two or more audio tracks.

- 1 During play, tap anywhere except for the upper left corner to display the control bar.
- 2 Tap **🔊** repeatedly to select audio track.
 - ↳ The audio channel information is displayed on upper line of the screen.

Tip

- You can also press **DVD AUDIO** on the remote control repeatedly to change audio track.

Select subtitle language

For DVD or DivX discs that contain two or more subtitle languages.

- 1 During play, tap anywhere except for the upper left corner to display the control bar.
- 2 Tap **🗣️** repeatedly to select a language.
 - ↳ The selected language is displayed.

Tip

- You may also press **SUBTITLE** on the remote control repeatedly to select subtitle language.

Repeat one/all chapter

During play, you can select different repeat play modes.

For DVD/VCD movie disc:

- 1 Tap anywhere except for the upper left corner to display the control bar.
- 2 Tap **🔁** to display the second menu.

- 3 Tap  to select:
- **[Rep: chapter]:** play the current chapter repeatedly.
 - **[Rep: title]:** play all chapters in the title repeatedly.
 - **[Rep: disc]:** cancel repeat play.



For VCD karaoke:

Tap  to select:

- **[Rep: one]:** play the current track repeatedly.
- **[Rep: disc]:** cancel repeat play.



For CD/MP3/WMA audio files:

Tap  on the upper line of the screen to select:

-  : play the current track repeatedly.
-  : play all tracks in the current folder repeatedly.
-  : cancel repeat play.

Random play

You can play audio tracks/files in random order. During play, tap  repeatedly to turn random play on or off.

-  (red): start random play.
-  (gray): cancel random play.

Select audio mode

When you play VCDs, you can select an audio mode (R/L/Stereo).

- 1 During play, tap anywhere except for the upper left corner to display the control bar.
- 2 Tap  repeatedly until the preferred audio mode is selected.

View photo

- 1 Tap .
 - ↳ Thumbnail view of the pictures is displayed.

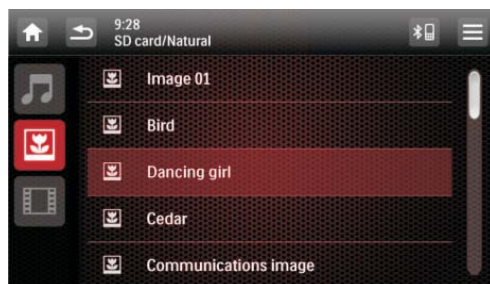

- 2 Drag the bar downward to view all pictures.
- 3 Tap on a picture to view it in full screen.



Tip

- You can also press  on the remote control to view picture list.

Zoom

You can zoom in pictures for a close view.



- 1 During view pictures, tap anywhere except for the upper left corner to display the control bar.
- 2 Tap  repeatedly to zoom in/out the picture.

Rotate pictures

- 1 During view pictures, tap anywhere except for the upper left corner to display the control bar.
- 2 Tap  repeatedly to rotate the picture.

5 Listen to radio

Tune to a radio station

- 1 Tap  to display home menu.
- 2 Tap .
 - ↳ Band and frequency information is displayed.



- 3 Tap **FM** or **AM** to select band:
 - FM band options: **FM1**, **FM2**, **FM3**
 - AM band options: **AM1**, **AM2**
- 4 Briefly tap **<** or **>** to tune to a radio station by step.
 - Tap **<** or **>** for over one second to tune to a radio station automatically.

Tip

- You can also press **BAND** on the front panel or remote control repeatedly to select the band.

Select radio range

Before you start to search for radio stations, you can select radio range.

- 1 Tap .
- 2 Tap **[Radio Range]** to toggle tuner sensitivity from normal to high sensitivity.
 - **[Distance]**: only stations with strong signals can be broadcast.

- **[Local]:** stations with strong and weak signals can be broadcast.



Store radio stations in memory

You can store up to 6 stations in each band.

Store stations manually

- 1 Select band.
- 2 Tune to the station by tapping < or >.
- 3 Tap and hold one of the channels 1 to 6 over two seconds.
 - ↳ The station is saved under the selected channel.

Store stations automatically

You can search for a station with intro search, which broadcasts a 10-second preview of each detected radio station.

- 1 Select band.
- 2 Tap ☰.
- 3 Tap **[Auto Store]**.
 - ↳ Auto search starts. The six strongest stations of the selected band are saved in preset channels 1-6 automatically.

Tune to a preset station

- 1 Select band.
- 2 Tap one of the preset channels (1 to 6) to select a preset station.



Play with RDS (Optional)

The RDS (Radio Data System) function operates only in areas with FM stations broadcasting RDS signals. If you tune to an RDS station, an RDS icon and information about the presenter, station or program is displayed.

Turn on RDS

- 1 Under radio mode, tap ☰
 - ↳ The radio option menu is displayed.
- 2 Tap **[On]** to turn on the RDS function.



Select program type

Before tuning to RDS stations, you can select program type and let the unit search only for programs of the selected category.

- 1 Under radio mode, tap 
↳ The radio option menu is displayed.
- 2 Tap **[PTY list]**.
↳ The PTY list of available program type is displayed.



- 3 Swipe your finger on screen repeatedly to select an option.
↳ The setting is changed.

RDS program types

Item	Program type	Description
1	NEWS	News services
2	AFFAIRS	Politics and current affairs
3	INFO	Special information programs
4	SPORT	Sports
5	EDUCATE	Education and advanced training
6	DRAMA	Radio plays and literature
7	CULTURE	Culture, religion and society
8	SCIENCE	Science
9	VARIED	Entertainment programs
10	POP M	Pop music

11	ROCK M	Rock music
12	MOR M	Light music
13	LIGHT M	Light classical music
14	CLASSICS	Classical music
15	OTHER M	Special music programs
16	WEATHER	Weather
17	FINANCE	Finance
18	CHILDREN	Children's programs
19	SOCIAL	Social Affairs
20	RELIGION	Religion
21	PHONE IN	Phone In
22	TRAVEL	Travel
23	LEISURE	Leisure
24	JAZZ	Jazz Music
25	COUNTRY	Country Music
26	NATION M	National Music
27	OLDIES	Oldies Music
28	FOLK M	Folk Music
29	DOCUMENT	Documentary
30	TEST	Alarm Test
31	ALARM	Alarm



Activate AF/TA functions

Tap **AF/TA** on upper line of the screen to turn on/off the corresponding function.



- **AF** (alternate frequency): automatically searches for a different station when the tuner cannot get a good reception.
- **TA** (traffic announcement): allows you to receive traffic announcements automatically no matter what source you are listening to.

6 Use navigation system

- 1 Tap  to display main menu.
- 2 Tap .
 - ↳ The navigation menu is displayed in a few seconds.
- 3 Refer to the user manual of the navigation map to operate the navigation tool.

Insert map card



Note

- Navigation map card is not included in the packaging of the car entertainment system.

- 1 Press **OPEN** to release the panel.
- 2 Open the card door under the screen.
- 3 Insert the map card into the map card slot.

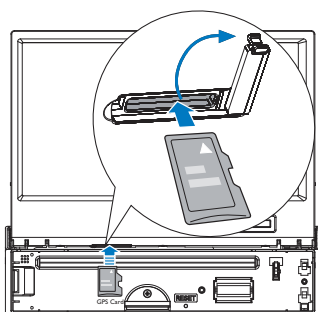

- 4 Close the card door.
- 5 Attach the front panel.



Tip

- You can press **NAVI** to enter/exit the navigation system.

Use map



Note

- You might need to upgrade the navigation map (sold separately) before using it. See "Upgrade the map" section.

7 Play with Bluetooth device

You can make or receive phone calls with Bluetooth-enabled phones through the unit. You can also listen to music from a Bluetooth-enabled device.



Pair the Bluetooth-enabled devices

To connect your Bluetooth device to the unit, you need to pair the device to the unit. Pairing needs only to be done once. You can pair up to eight devices.

Note

- The operational range between this unit and a Bluetooth device is approximately 10 meters (30 feet).
- Before you connect a Bluetooth device to this unit, familiarize yourself with the Bluetooth capabilities of the device.
- Compatibility with all Bluetooth devices is not guaranteed.
- Any obstacle between this unit and a Bluetooth device can reduce the operational range.
- Keep this unit away from any other electronic device that may cause interference.

Pairing with unit

- 1 Tap  to display home menu.
- 2 Tap .
↳ The setting menu is displayed.
- 3 Tap  to display Bluetooth setting menu.
- 4 Tap **[New Pairing]** to search for Bluetooth device with your device.
- 5 Select the name of desired device in the pairing list.

- 6 Enter default password "0000" in your device.
↳ If the pairing succeeds, the phone call record is displayed.





Pairing with mobile phone

- 1 Open your mobile phone and switch on Bluetooth.
- 2 Search for other Bluetooth device with your device.
- 3 Select "CED780" in the pairing list.
- 4 Enter default password "0000".
↳ If the pairing succeeds, the dial screen is displayed.





Disconnect Bluetooth devices

- 1 Under dial screen/Bluetooth audio mode, tap .
- 2 Tap **[Paired Device]**.
↳ The Bluetooth/Paired device screen is displayed.



- 3 Tap on one device that you want to reconnect/disconnect.
- Tap  (green) to reconnect the selected device.
 - Tap  (red) to disconnect the selected device.

Tip

- If the Bluetooth device is paired, under disconnect mode, tap  on top of the screen into the Bluetooth/paired device list.
- If there is no Bluetooth device in the paired device list, tap  on top of the screen, "Paired list is empty" is displayed, you can tap  to search the device.
- If you do not want to reconnect the device to the unit automatically, under Setting menu, tap  > [Auto Connect], then select [Off]. For details, see "Adjust Bluetooth settings" section.

Make a call

You can make phone call with the unit under any mode.



Note

- Ensure that the phone is connected to the unit via Bluetooth.

- 1 Tap  on top of the screen.
↳ The dial screen is displayed.



- 2 Tap number icons directly to input phone number.
- Tap  to clear the last input.

- Tap  to clear all input.
- Tap  to go back to previous screen.

- 3 Tap  to start calling.



- 4 During talking, tap  to display the keypad.

Receive call



By default, all incoming calls are received automatically.

Note

- You can select to receive calls manually by set [Auto Answer] to [Off] status. For details, refer to "Adjust Bluetooth settings".

- 1 If there is an incoming call, [Incoming call...] is displayed on the screen.



- 2 Tap  (green) to answer/accept the call.
- 3 When conversation ends, tap  (red) to terminate the call.

Tip

- You can also press  /  on front panel to answer/terminate the call.

Switch phone call to mobile phone

If you do not want your passenger to hear your incoming call, you can switch the call the mobile phone.

During talking, tap .



- ↳ The voice is transferred from the loudspeaker to the mobile phone.

Tip

- You can also press and hold  on front panel to transfer the call.

Bluetooth phone book settings

The users are allowed to search and dial the number stored in the phone book.

- 1 Tap  on top of the screen.
↳ The dial screen is displayed.
- 2 Tap  to display the phone book mode.
↳ Tap **[Sync]** to synchronize phone book.





- 3 Search the number you want to dial, then tap  to start calling.

Tip

- You can enter desired name/number on the keypad to search quickly.

Favorite call

You can make a favorite call from the favorite call list.

- 1 Tap  on top of screen.
↳ The dial screen is displayed.
- 2 Tap  to display the favorite call list.



- 3 Tap on desired number to start calling.

Adjust Bluetooth settings

- 1 In the Bluetooth menu, tap 
↳ The option menu is displayed.









- **[Display Design]**: change the background.

- [New Pairing]: pair the new device.
- [Paired Device]: display paired device.

2 Tap an option to change the setting.

Listen to music from Bluetooth device

If the connected Bluetooth device supports Advanced Audio Distribution Profile (A2DP), you can listen to the music stored on the device through the unit. If the device also supports Audio Video Remote Control Profile (AVRCP) profile, you can use the control on the unit or its remote control to play music stored on the device.

- 1 Pair the phone with the unit.
- 2 Tap  to return to home menu.
- 3 Tap .
- 4 The Bluetooth menu is displayed.
 - Tap : switch to music mode.
 - Tap : switch to dial screen mode.
 - Tap : switch to phone book.
 - Tap : switch to favorite list.



8 Play iPod/iPhone

Compatible iPod/iPhone

The car audio system supports below iPod/iPhone models:

Made for:

- iPod touch (4th generation)
- iPod touch (3rd generation)
- iPod touch (2nd generation)
- iPod touch (1st generation)
- iPod classic
- iPod nano (6th generation)
- iPod nano (5th generation)
- iPod nano (4th generation)
- iPod nano (3rd generation)
- iPod nano (2nd generation)
- iPod nano (1st generation)

Works with:

- iPhone 4
- iPhone 3GS
- iPhone 3G
- iPhone

Listen to the iPod/iPhone

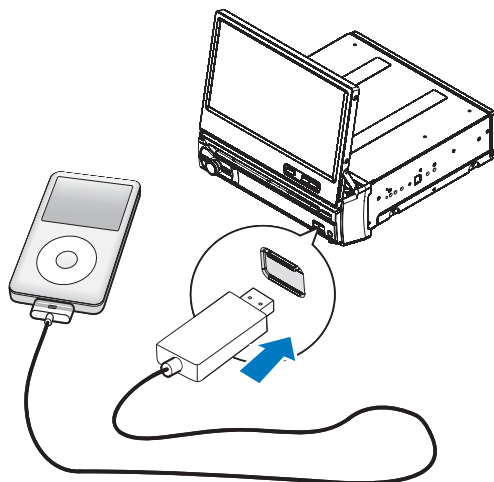

- 1 Connect your iPod/iPhone to the front USB socket via Apple's own 30pin USB cable.
↳ Music playback starts.



- 2 To pause/resume play, tap **II**.
- 3 To skip a track, tap **⏮** / **⏭**.
- 4 To fast backward/forward, tap and hold **⏮** / **⏭**.
- 5 Tap **⏮** repeatedly to toggle between two control modes:
 - **iPod control mode:** use buttons/touch screen on iPod/iPhone to control the music.
 - **Unit control mode:** tap screen on car audio to control the music.

Search for a track

During play from iPod/iPhone, you can search through the music/video files to select preferred file for listening/watching.

- 1 During playing, tap **⏮**.
↳ Search list is displayed.



- 2 Tap **⏮** to select folder/file.
- 3 Tap on the screen to select desired song.
- 4 Tap on the selected song to play.

Charge the iPod/iPhone

When the iPod/iPhone is connected to the car audio system, the iPod/iPhone begins to charge.



Tip

- For certain iPod models, it may take up to one minute before the charging indication is displayed.

9 Adjust sound

Adjust volume

Rotate \odot clockwise/counterclockwise to increase/decrease the volume.

Mute

You can turn off the sound of your audio. During play, press \odot / \otimes on front panel.

- To resume sound, press \odot / \otimes on front panel again.

Select preset equalizer

- 1 Tap EQ .
↳ The current equalizer setting is displayed.



- 2 Tap < or > to select a preset EQ:
 - [Custom]
 - [Techno]
 - [Rock]
 - [Classic]
 - [Jazz]
 - [Optimal]
 - [Flat]
 - [Pop]

- 3 Adjust EQ settings by tapping on the screen.
 - [Bass] bass range: -14 to +14.
 - [Middle] middle range: -14 to +14.
 - [Treble] treble range: -14 to +14.
 - [LPH] low pass filter range: 60, 80, 100, 160.
 - [MPF] middle pass filter range: 0.5KHz, 1.0KHz, 1.5KHz, 2.5KHz.
 - [HPF] high pass filter range: 10.0KHz, 12.5KHz, 15.0KHz, 17.5KHz.
- 4 If you are not satisfied with the adjusted sound settings, tap ↺ to restore default settings.
- 5 Tap ↵ to exit.

Adjust fader/balance/subwoofer

You can adjust the sound balance between the front, rear, left, and right speakers and subwoofer.

- 1 Tap Fader/Balance on upper line of the screen to display setting menu.
- 2 Tap Fader/Balance .



- 3 Tap + or - to adjust fader/balance value.
 - [Fader] fader range: +16 to -16. (F = front speaker; R = rear speaker)
 - [Balance] balance range: -16 to +16. (L = left speaker; R = right speaker)

- 4 Tap .
 - ↳ The subwoofer setting is displayed.





- **[Subwoofer]:** tap **[On]/[Off]** on screen to turn the subwoofer on or off.
- Tap **+** or **-** to select subwoofer volume: 0 to 14.
- **[LPF]:** tap screen to select subwoofer low pass filter range: 80, 120, 160.

- 5 Tap  to exit.

Switch music listening zone

Philips' innovative Zone technology enables driver or passengers to enjoy music with the best speakers balance and experience more vivid spacial effect as the artist is intended to create. You can switch the music listening zone from driver to passengers for the best speaker sound settings in car.

- 1 Tap  on the upper line of the screen to display setting menu .
- 2 Tap  twice.
- 3 The music zone setting is displayed.





- 4 Tap on the screen to adjust music listening zone setting.

Turn FullSound on/off

Philips FullSound restores the audio details that is lost in music compression. It enriches the music signal, so what you hear is the full sound with every nuance of emotion and every detail of musical genius. Philips FullSound can:

- Bring CD listening experience to MP3
- Achieve fuller bass with greater depth and impact
- Restore sense of spaciousness that is lacking in compressed audio
- Enhance sound precision and detail

- 1 Tap  on the upper line of the screen to display setting menu.
- 2 Tap .
- 3 The full sound setting is displayed.





- 4 Tap 1/2/3 on the screen to adjust full sound setting.

Tip

- You can also tap  on the upper line of the screen to activate the full sound.

Turn MAX sound on/off



During play, tap  on the upper line of screen.

-  (red): turn maximizing sound (MAX sound) on.
-  (gray): turn maximizing sound (MAX sound) off.

Turn DBB on/off

When DBB (Dynamic Bass Boost) is activated, low tones will be enhanced electronically.

Tap  on the upper line of screen to toggle between the settings.

-  (red): DBB (Dynamic Bass Boost) function is activated.
-  (gray): DBB (Dynamic Bass Boost) function is deactivated.

10 Adjust settings

Display system setup menu

- 1 Tap  >  to display the full menu.



- 2 Tap .
 - ↳ The settings menu is displayed.

Adjust general settings

- 1 Tap .



- 2 Drag the bar downward to view all settings.
- 3 Swipe your finger on screen repeatedly to select an option.
 - ↳ The setting is changed.

General settings	Options	Description
[Radio Region]		Select one that matches your location.
[Beep]	[On]	Turn the beep sound on. Each time you press a button, the unit beeps.
	[Off]	Turn off the beep sound.
[Language]		Select OSD (on screen display) language.
[Calibration]		Calibrate the touch screen.
[Clock Mode]	[12Hr]/[24Hr]	Select time format.
[Date]		Set date.
[Time]		Set time.
[Parking]	[On]	Turn parking on.
	[Off]	Turn parking off.
[Camera]	[PAL/NTSC]	Select camera format.
[Demo] (Auto start after power off)	[On]	Turn demo mode on.
	[Off]	Turn demo mode off.

4 Tap  to exit.

View Info settings

1 Tap .



2 Drag the bar downward to view all detailed information of the system.

Adjust Navigation settings

1 Tap .



2 Swipe your finger on screen repeatedly to select an option.
 The setting is changed.

Navigation settings	Options	Description
[Navigation Program Path]		Access the Navigation Program Path mode.
[Navigation Voice]	[On]	Turn the navigation voice on.
	[Off]	Turn the navigation voice off.
[Navigation Voice Gain]	[High]	Select the navigation voice to high.
	[Low]	Select the navigation voice to low.

3 Tap  to exit.

Adjust Bluetooth settings

1 Tap .



2 Tap on a setting repeatedly to change setting.

Bluetooth settings	Options	Description
[New Pairing]		Pair new device.
[Auto Connect]	[On]	If the pre-paired device is within effective range, the system reconnects to pre-paired device automatically.
	[Off]	Need to reconnect manually.
[Auto Answer]	[On]	Answer paired phone call automatically.
	[Off]	Answer phone call manually.
[Pin Code]		Set code for pairing the car entertainment system with other Bluetooth devices. The default code is 0000.
[Device Name]		View the name of paired device.

3 Tap  to exit.

11 Others

Adjust brightness

- 1 Press **DISP** on front panel repeatedly to adjust the dimmer settings.
- 2 Press and hold **DISP** to turn off the display, press again or tap on TFT screen to switch on.

Set rear view camera

If you connected a rear view camera, you can see from the screen of the car audio system what the camera takes when the back lamp lights up.

↳ Picture from rear camera is displayed.



Tip

- The default camera is NTSC system. Go to setting menu to set PAL system, if your camera is not NTSC system.

Adjust display design

You can change the background screen on the playback mode.

- 1 In any mode, tap .
↳ The option menu is displayed.
- 2 Tap **[Display Design]** to set the options.



- **[Wallpaper]**: tap to change wallpaper on screen.
- **[Visualizer]**: tap to change visualizer on screen.
- **[Skin]**: tap to change OSD display color.
- **[Backlight]**: tap to change main unit button illumination color.

- 3 Tap  to exit.

Listen to other devices

You can connect an external audio/video device to the car audio system.

- 1 Connect the car audio to the device with the supplied AV cable.

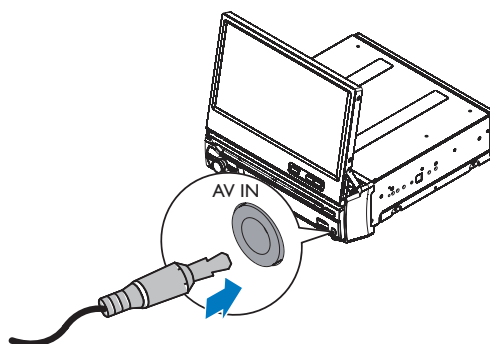

- 2 Tap  to display home menu.
- 3 Tap  **[AV-IN1]**.

- Operate the connected the device (see instruction manual of the device).

Tip

- If you connect the system to other audio devices through the **REAR OUT L/R** connector (see "Wiring Diagram" section), tap **[AV-IN2]** to listen to that device.

Detach the front panel

You can detach the front panel to deter theft.

- Press **OPEN** to release the panel.
- Push the right side of the panel leftward.

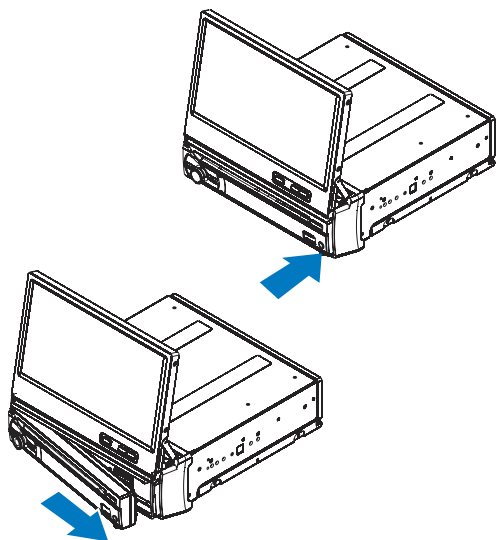

- Pull the panel towards you to disengage it from the chassis.
- Store the panel in the supplied carrying case to protect it from dirt or damage.

Reset

When the unit hangs up, you can reset it. Press **RESET** with a ball-point pen or similar tool.

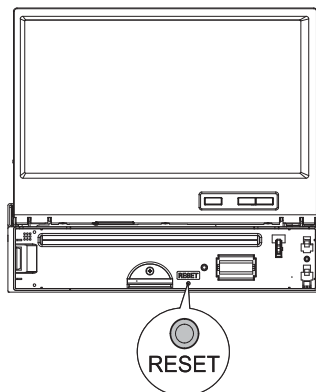

Tip

- When the unit is reset, all the settings remain unchanged.

Replace fuse

If there is no power, the fuse may be damaged and need to be replaced.

- Take out the unit from dashboard.
- Check the electric connection.
- Buy a fuse that matches the voltage of the damaged fuse (15A).
- Replace the fuse.

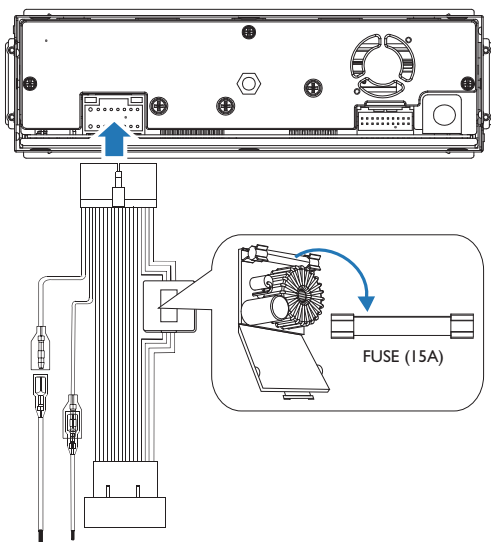

Tip

- If the fuse breaks immediately after it has been replaced, there may be an internal malfunction. In this case, consult your Philips dealer.

12 Product information



Note

- Product information is subject to change without prior notice.

General

Power supply	12V DC (11V - 16V), negative ground
Fuse	15 A
Suitable speaker impedance	4 - 8 Ω
Maximum power output	50 W \times 4 channels
Continuous power output	24 W \times 4 channels (4 Ω 10% T.H.D.)
Pre-Amp output voltage	4.0V (CD play mode; 1 kHz, 0 dB, 10 k Ω load)
Subwoofer output voltage	4.0V (CD play mode, 61 Hz, 0 dB, 10 k Ω load)
Aux-in level	\geq 800 mV
Dimensions (W \times H \times D)	182 \times 53 \times 210 mm
Weight (main unit)	3.1 kg

Disc player

System	DVD / CD audio / MP3 system
Frequency response	20 Hz - 20k Hz
Signal/noise ratio	>75dB
Total harmonic distortion	Less than 0.3%
Channel separation	>50dB
Video signal format	NTSC/PAL only
Video output	1 +/- 0.2V p-p

Radio

Frequency range - FM	87.5 - 108.0 MHz (50kHz per step)
Frequency range - AM(MW)	522 - 1620 KHz (9kHz per step)
Usable sensitivity - FM	5 µV
Usable sensitivity - AM (MW)	25 µV

LCD

Screen size	7.0 inches
Display resolution	800 x 480 dots
Contrast ratio	500
Brightness	450 cd/m2

Bluetooth

Communication system	Bluetooth Standard version 2.0
Output	Bluetooth Standard Power Class 2
Maximum communication range	Line of sight approx. 8m
Frequency band	2.4 GHz band (2.4000 GHz - 2.4835 GHz)
Compatible Bluetooth profiles	Hands-Free Profile (HFP) Handset Profile (HSP) Advanced Audio Distribution Profile (A2DP) Audio Video Remote Control Profile (AVRCP)
Supported codecs	
Receive	SBC (Sub Band Codec)
Transmit	SBC (Sub Band Codec)

USB playability information

Compatible USB devices:

- USB flash memory (USB 2.0 or USB1.1)
- Memory cards (SD / SDHC)

Supported USB formats:

- USB or memory file format: FAT16, FAT32

Supported MP3 disc format:

- ISO9660, Joliet
- MP3 bit rate (data rate): 32-320 Kbps and variable bit rate
- WMA v9 or earlier
- Number of tracks/titles: maximum 9000
- ID3 tag v2.0 or later
- Supported sampling frequencies: 32 kHz, 44.1 kHz, 48 kHz
- Supported Bit-rates: 32-320 Kbps and variable bit rate

Supported video formats:

The following video formats (containers) are supported on current product:

- MPEG1 (*.avi, *.mpg, *.dat)
- MPEG4 (simple profile) (*.avi)
- DIVX4 (*.avi)
- DIVX5 (*.avi)
- XVID (*.avi)

Note

- To ensure a better playback, it is recommended that file image size is no higher than 640 x 480, frame rate is 20 fps, data rate is no higher than 500 kbps.

Unsupported video formats:

The following video formats (containers) cannot be supported on current product:

- M-JPEG (*.avi, *.mov)
- MPEG4 (*.mov, *.wmv, *.mp4, *.3g2, *.asf, *.3gp)
- H.263 (*.avi, *.mov, *.flv, *.3gp)
- H.264 (*.mp4, *.mov)
- WMV3 (*.wmv, *.avi)
- WMV2 (*.wmv)
- RealVideo4 (*.rmvb, *.rm)

- RealVideo3 (*.rm)
- RealVideo2 (*.ram)
- MS Video (*.avi)



Note

- For format (container) not listed above, it is not guaranteed to work. Please avoid from using with the product.

13 Troubleshooting



Warning

- Never remove the casing of this device.

To keep the warranty valid, never try to repair the system yourself.

If you encounter problems when using this device, check the following points before requesting service. If the problem remains unsolved, go to the Philips web site (www.philips.com/support). When you contact Philips, ensure that the device is nearby and the model number and serial number are available.

No power

- Car engine has not been started. Start the car engine.
- Connections are incorrect.
- Fuse has been damaged. Replace fuse.

No sound

- Volume is too low. Adjust volume.
- Speaker connections are incorrect.

No response to the remote control

- Ensure that the path between the remote control and the unit is clear from obstacles.
- From a close distance, point the remote control directly at the unit.
- Switch **F/R** to correct position (**F** for front control and **R** for rear control).
- The function does not work. See the instruction manual.
- Replace the remote control battery.

Disc does not play

- Disc is upside down. Ensure that the printed side is upwards.
- Disc is dirty. Clean the disc with a clean, soft, lint-free cloth. Wipe the disc outwards from the center.
- Disc is defective. Try another disc.
- incompatible disc is used. Try another disc.
- Disc rating exceeds the restriction setting. Change the rating settings to lower one.

- Disc region code is not compatible with the unit. Use disc with proper region code.

No image

- Parking wire connection is incorrect. Check the wiring.

No image on rear display

- Check if you are playing DivX video. If yes, it's normal, for this device does not support video out in DivX playing mode.

Image flashes or distorted

- Video DVD settings do not match with the DVD. Adjust video DVD settings.
- Video connection is improper. Check the connections.

Noise in broadcasts.

- Signals are too weak. Select other stations with stronger signals.
- Check the connection of the car antenna.
- Change broadcast from stereo to mono.

Preset stations lost.

- Battery cable is not correctly connected. Connect the battery cable to the terminal that is always live.

Fuse is broken

- The fuse type is incorrect. Replace it with a 15A fuse.
- Speaker wire or power wire is grounded. Check the connections.

Cannot connect with the system.

- The device does not support the profiles required for the system.
- The Bluetooth function of the device is not enabled. Refer to the user manual of the device to find out how to enable the function.
- The system is not in the pairing mode.
- The system is already connected with another Bluetooth-enabled device. Disconnect that device or all other connected devices and then try again.

The paired mobile phone connects and disconnects constantly.

- The Bluetooth reception is poor. Move the mobile phone closer to the system or remove any obstacle between the mobile phone and the system.
- Some mobile phones may connect and disconnect constantly when you make or end calls. This does not indicate any malfunction of the system.
- For some mobile phones, the Bluetooth connection may be deactivated automatically as a power-saving feature. This does not indicate any malfunction of the system.

About the Bluetooth device

Music playback is unavailable on the system even after successful Bluetooth connection.

- The device cannot be used with the system to play music.

The audio quality is poor after connection with a Bluetooth-enabled device.

- The Bluetooth reception is poor. Move the device closer to the system or remove any obstacle between the device and the system.

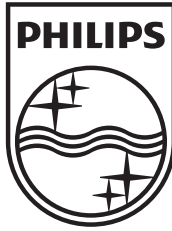

Specifications are subject to change without notice
© 2012 Koninklijke Philips Electronics N.V.
All rights reserved.

CED780_05_UM_V1.0

