

Register your product and get support at
www.philips.com/welcome

PD7040



EN User manual

PHILIPS

Contents

1	Important	4
	Important Safety Instructions	4
	Notice	7
2	Your portable DVD player	10
	Introduction	10
	What's in the box	10
	Overview of the main unit	11
	Overview of the remote control	13
3	Get started	15
	Charge the battery	15
	Install remote control battery	16
	Connect additional equipment	17
4	Use your player	17
	Turn on	17
	Select OSD language	17
	Play discs	18
	Play from USB	18
	Play options	18
	Adjust brightness of screen backlight	19
5	Adjust settings	20
6	Product information	21
7	Troubleshooting	22

1 Important

Important Safety Instructions

- ① Read these instructions.
- ② Keep these instructions.
- ③ Heed all warnings.
- ④ Follow all instructions.
- ⑤ Do not use this apparatus near water.
- ⑥ Clean only with dry cloth.
- ⑦ Do not block any ventilation openings. Install in accordance with the manufacturer's instructions.
- ⑧ Do not install near any heat sources such as radiators, heat registers, stoves, or other apparatus (including amplifiers) that produce heat.
- ⑨ For countries with a polarized mains, do not defeat the safety purpose of the polarized or grounding-type plug. A polarized plug has two blades with one wider than the other. A grounding type plug has two blades and a third grounding prong. The wide blade or the third prong are provided for your safety. If the provided plug does not fit into your outlet, consult an electrician for replacement of the obsolete outlet.

Caution: To prevent electric shock, match the wide blade of the plug to the wide slot, fully insert.



- ⑩ Protect the power cord from being walked on or pinched, particularly at plugs, convenience receptacles, and the point where they exit from the apparatus.
- ⑪ Only use attachments/accessories specified by the manufacturer.
- ⑫ Use only with the cart, stand, tripod, bracket, or table specified by the manufacturer or sold with the apparatus. When a cart is used, use caution when moving the cart/apparatus combination to avoid injury from tip-over.



- ⑬ Unplug this apparatus during lightning storms or when unused for long periods of time.
- ⑭ Refer all servicing to qualified service personnel. Servicing is required when the apparatus has been damaged in any way, such as power-supply cord or plug is damaged, liquid has been spilled or objects have fallen into the apparatus, the apparatus has been exposed to rain or moisture, does not operate normally, or has been dropped.
- ⑮ Batteries (battery pack or batteries installed) shall not be exposed to excessive heat such as sunshine, fire or the like.
- ⑯ Apparatus shall not be exposed to dripping or splashing.
- ⑰ Do not place any sources of danger on the apparatus (e.g. liquid filled objects, lighted candles).
- ⑱ This product may contain lead and mercury. Disposal of these materials may be regulated due to environmental considerations. For disposal or recycling information, please contact your local authorities or the Electronic Industries Alliance: www.eiae.org.
- ⑲ Where the MAINS plug or an appliance coupler is used as the disconnect device, the disconnect device shall remain readily operable.

 **Warning**

- Never remove the casing of this apparatus.
- Never lubricate any part of this apparatus.
- Never place this apparatus on other electrical equipment.
- Keep this apparatus away from direct sunlight, naked flames or heat.
- Never look into the laser beam inside this apparatus.
- Ensure that you always have easy access to the power cord, plug or adaptor to disconnect this apparatus from the power.

Hearing safety

Listen at a moderate volume.

- Using headphones at a high volume can impair your hearing. This product can produce sounds in decibel ranges that may cause hearing loss for a normal person, even for exposure less than a minute. The higher decibel ranges are offered for those that may have already experienced some hearing loss.
- Sound can be deceiving. Over time your hearing 'comfort level' adapts to higher volumes of sound. So after prolonged listening, what sounds 'normal' can actually be loud and harmful to your hearing. To guard against this, set your volume to a safe level before your hearing adapts and leave it there.

To establish a safe volume level:

- Set your volume control at a low setting.
- Slowly increase the sound until you can hear it comfortably and clearly, without distortion.

Listen for reasonable periods of time:

- Prolonged exposure to sound, even at normally 'safe' levels, can also cause hearing loss.
- Be sure to use your equipment reasonably and take appropriate breaks.

Be sure to observe the following guidelines when using your headphones.

- Listen at reasonable volumes for reasonable periods of time.
- Be careful not to adjust the volume as your hearing adapts.
- Do not turn up the volume so high that you can't hear what's around you.
- You should use caution or temporarily discontinue use in potentially hazardous situations. Do not use headphones while operating a motorized vehicle, cycling, skateboarding, etc.; it may create a traffic hazard and is illegal in many areas.



Caution

- Use of controls or adjustments or performance of procedures other than herein may result in hazardous radiation exposure or other unsafe operation.

Notice

Any changes or modifications made to this device that are not expressly approved by Philips Consumer Lifestyle may void the user's authority to operate the equipment.



This product complies with the radio interference requirements of the European Community.

Environmental information

All unnecessary packaging has been omitted. We have tried to make the packaging easy to separate into three materials: cardboard (box), polystyrene foam (buffer) and polyethylene (bags, protective foam sheet.) Your system consists of materials which can be recycled and reused if disassembled by a specialized company. Please observe the local regulations regarding the disposal of packaging materials, exhausted batteries and old equipment.

Recycling



Your product is designed and manufactured with high quality materials and components, which can be recycled and reused. When you see the crossed-out wheel bin symbol attached to a product, it means the product is covered by the European Directive 2002/96/EC:



Never dispose of your product with other household waste. Please inform yourself about the local rules on the separate collection of electrical and electronic products. The correct disposal of your old product helps prevent potentially negative consequences on the environment and human health.

Your product contains batteries covered by the European Directive 2006/66/EC, which cannot be disposed of with normal household waste. Please inform yourself about the local rules on separate collection of batteries. The correct disposal of batteries helps prevent potentially negative consequences on the environment and human health. Always bring your product to a professional to remove the built-in battery.

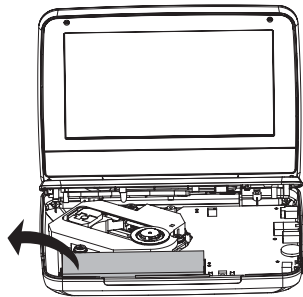

The making of unauthorized copies of copy-protected material, including computer programs, files, broadcasts and sound recordings, may be an infringement of copyrights and constitute a criminal offence. This equipment should not be used for such purposes. Recording and playback of material might require consent. See Copyright Act 1956 and The Performer's Protection Acts 1958 to 1972. This product incorporates copyright protection technology that is protected by method claims of certain U.S. patents and other intellectual property rights owned by Macrovision Corporation and other rights owners. Use of this copyright protection technology must be authorized by Macrovision Corporation, and is intended for home and other limited viewing uses only unless otherwise authorized by Macrovision Corporation. Reverse engineering or disassembly is prohibited.



"DivX, DivX" Certified, and associated logos are trademarks of DivX, Inc. and are used under license.



Manufactured under license from Dolby Laboratories.
"Dolby" and the double-D symbol are trademarks of Dolby Laboratories.

Norge

Typeskilt finnes på apparatens underside.

Observer: Nettbryteren er sekundært innkoplet. Den innebygde nettdelen er derfor ikke frakoplet nettet så lenge apparatet er tilsluttet nettkontakten.

For å redusere faren for brann eller elektrisk støt, skal apparatet ikke utsettes for regn eller fuktighet.

This apparatus includes this label:



2 Your portable DVD player

Congratulations on your purchase, and welcome to Philips! To fully benefit from the support that Philips offers, register your product at www.philips.com/welcome.

Introduction

Your portable DVD player plays digital video discs that conform to the universal DVD Video standard. With it, you can play movies with true cinema picture quality and stereo or multi-channel sound (depending on disc and playback set-up).

You can also select sound track, subtitle languages, and some play options. Besides, you can restrict the play of discs that are not suitable for children.

You can play the following discs on the DVD player (including CD-R, CD-RW, DVD±R and DVD±RW):

- DVD-Video
- Video CD
- Audio CD
- MP3 CD
- DivX
- Discs with JPEG files

What's in the box







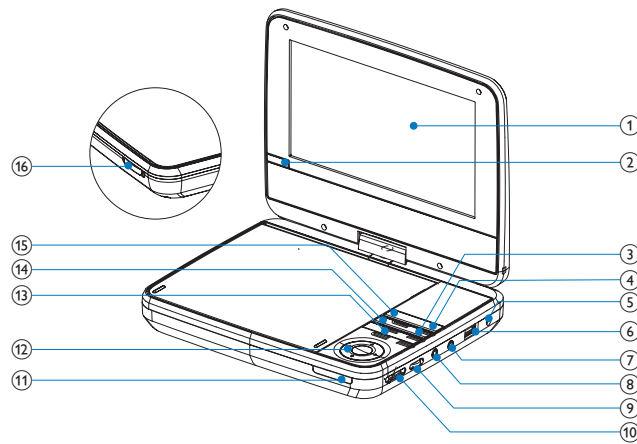





Check and identify the contents of your package:

- Portable DVD player
- AC power adaptor, ASUC12E-090080 (Philips)
- Car adaptor
- Mounting bag
- Composit AV cable
- User Manual
- Quick Start Guide

Overview of the main unit



- ① **Display panel**
- ② **IR**
 - Remote control sensor.
- ③ **■**
 - Stops disc play.
- ④ **OPTIONS**
 - Accesses options relating to the current activity or selection.
- ⑤ **DC IN**
 - Power supply socket.
- ⑥ **USB**
 - Connects a USB device.
- ⑦ **Headphone jack**
 - Headphone jack.
- ⑧ **AV OUT**
 - Audio/video output jack.

- ⑨ **VOLUME** 
 - Increases or decreases volume.
- ⑩ **POWER ON/OFF (CHR)**
 - Turns on/off DVD player.
- ⑪ **CHR** 
 - Charging indicator/Power indicator.
- ⑫ **, , , **
 - Navigates menus.
 - , 
 - Searches backward/forward at different speeds.
-  **OK****
 - Confirms an entry or selection.
 - Starts, pauses or resumes disc play.
- ⑬ **, **
 - Skips to the previous or next title, chapter, or track.
- ⑭ **DISC MENU**
 - For DVD, accesses or exits disc menu.
 - For VCD, turns on or off PBC (Playback Control) mode.
 - For VCD version 2.0 or SVCD with PBC turned on, returns to the menu.
- ⑮ **SOURCE**
 - Switches between DVD and USB
- ⑯ **OPEN** 
 - Opens the disc compartment.

Overview of the remote control

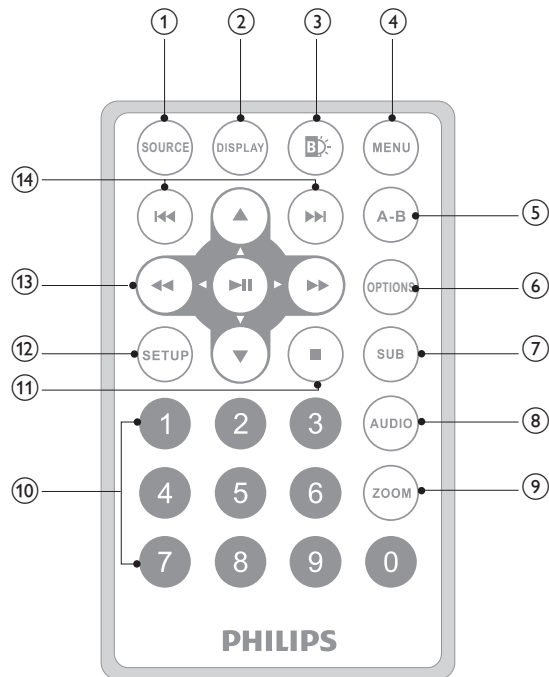

- ① **SOURCE**
 - Switches between DVD and USB.
- ② **DISPLAY**
 - Displays play information.
- ③ **Brightness icon**
 - Adjusts brightness of the screen backlight.

- ④ **MENU**
 - For DVD, accesses or exits disc menu.
 - For VCD, turns on or off PBC (Playback Control) mode.
 - For VCD version 2.0 or SVCD with PBC turned on, returns to the menu.
 - For a USB device, accesses or exits the file menu.
- ⑤ **A-B**
 - Marks the section for repeat play.
- ⑥ **OPTION**
 - Accesses options relating to the current activity or selection.
- ⑦ **SUB**
 - Selects a DVD subtitle language.
- ⑧ **AUDIO**
 - For DVD, selects an audio language.
 - For VCD, selects an audio mode.
- ⑨ **ZOOM**
 - Zooms into a video scene or picture.
- ⑩ **0-9**
 - Inputs numbers.
- ⑪ **■**
 - Stops disc play.
- ⑫ **SETUP**
 - Accesses or exits the setup menu.
- ⑬ **▶, ▼, ◀◀, ▶▶**
 - Navigates menus.
- ◀◀, ▶▶**
 - Searches backward/forward at different speeds.
- ▶||OK**
 - Confirms an entry or selection.
 - Starts, pauses or resumes disc play.
- ⑭ **◀◀▶▶**
 - Skips to the previous or next title, chapter, or track.

3 Get started

! Caution

- Use the controls only as stated in this user manual.
- Always follow the instructions in this chapter in sequence.

If you contact Philips, you will be asked for the model and serial number of your player. The model number and serial number are on the bottom of your player. Write the numbers here:

Model No. _____

Serial No. _____

Charge the battery

! Caution

- Risk of product damage! Ensure that the power supply voltage corresponds to the voltage printed on the bottom of the player.
- Use only the supplied AC adaptor to charge the battery.

≡ Note

- The type plate is located on the bottom of the player.
- You can only charge the player when it is in power-off mode.

- 1 Slide the **POWER ON/OFF (CHR)** switch to **OFF** position.
- 2 Connect the supplied AC adaptor to the player and to the AC outlet.

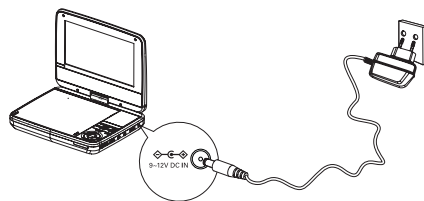

- ↳ The charge indicator turns on. It takes about 7.0 hours to fully charge the battery.
- ↳ When the battery is fully charged, the charge indicator turns off.

Install remote control battery

Caution

- Risk of explosion! Keep batteries away from heat, sunshine or fire. Never discard batteries in fire.
- Risk of decreased battery life! Never mix different brands or types of batteries.
- Risk of product damage! When the remote control is not used for long periods, remove the batteries.
- Danger of explosion if battery is incorrectly replaced. Replace only with the same or equivalent type.
- Perchlorate Material - special handling may apply. See www.dtsc.ca.gov/hazardouswaste/perchlorate.

For first-time use:

- 1 Remove the protective tab to activate the remote control battery.

To replace the remote control battery:

- 2 Open the battery compartment.
- 3 Insert 1 CR2025 battery with correct polarity (+/-) as indicated.
- 4 Close the battery compartment.

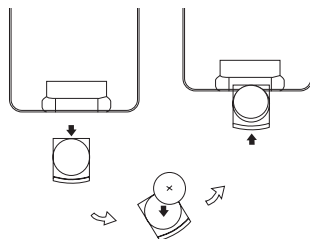

Connect additional equipment

! Caution

- Turn off your player before connecting to any additional equipment.

You can connect the player to a TV or an amplifier to enjoy DVDs or Karaoke.

Match the color of the AV cables (not supplied) with the jacks:

- the yellow cable is for the yellow video jack.
- the red/white cables are for the red/white audio jacks.

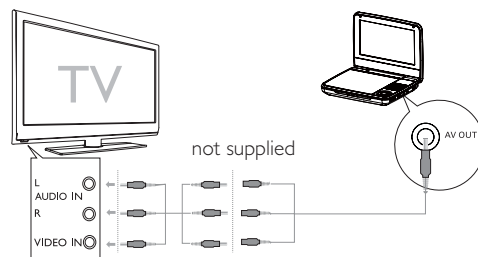

4 Use your player

Turn on

Slide the **POWER ON/OFF (CHR)** switch to the **ON** position.

↳ The  indicator turns on.

Select OSD language

You can choose a different language for the on-screen display text.

- 1 Press **SETUP**.
 - ↳ The setup menu appears.

- 2 Select **[General]** > **[Language]**.
- 3 Press **▶** to select an option.
- 4 Press **OK** to confirm.
- 5 Press **SETUP** to exit.

Play discs

- 1 Slide **OPEN▶** on the player.
- 2 Insert the disc with label side facing up.
- 3 Push down to close the disc compartment.
 - ↳ Play starts automatically. If not, press **▶|||OK**.
 - If a menu appears, select an item, then press **▶|||OK** to start play.
 - To pause, press **▶|||OK**. Press again to resume play.
 - To stop, press **STOP** twice.
 - To select the previous/next item, press **◀** or **▶**.
 - To start search within video/audio, press **◀** or **▶** once or more.

Play from USB

This player plays/views DivX, VOB, MP3, or JPEG files that are stored on USB devices.

- 1 Press **SOURCE** to switch to USB mode.
- 2 Connect the USB device to the player.
 - ↳ The content menu appears.
- 3 Select a file, then press **▶|||**.
 - ↳ Play starts.
- 4 To stop play, press **■** or remove the USB device.

Play options

- 1 During play, press **OPTIONS** to select some play options.
- 2 Follow the on-screen instructions.

Adjust brightness of screen backlight

 Note

- You can adjust brightness of the screen backlight to match lighting conditions.

During play, press **[F4]** repeatedly to select an option.

- **[Bright]**
- **[Normal]**
- **[Dim]**

 Tip

- To achieve the longest playtime, select **[Dim]**.
- To achieve the best view, select **[Bright]**.

5 Adjust settings

To maximize your play experience, use **SETUP** to fine tune your settings.

- 1 Press **SETUP**.
↳ The setup menu is displayed.
- 2 Use navigation keys to select an option and press **OK** to confirm.

[General]	
[Language]	Select on-screen display language
[PBC settings]	Set playback control function on/off.
[DivX (VOD)]	Get DivX registration code.
[DivX subtitles]	Select DivX subtitle language.
[Parental(DVD)]	Select parental options.
[Set password]	Change existing password.
[Factory settings]	Restore factory settings.
[Video]	
[LCD Display]	Set screen display aspect ratio.
[TV standard]	Set video output format to TV system.
[Brightness]	Adjust screen brightness.
[Contrast]	Adjust screen contrast.
[Audio]	
[Dolby]	Set Dolby output.
[Version]	Check the version information.

- 3 Press ◀ to go back to the previous menu.
- 4 Press **SETUP** to exit.

6 Product information

Note

- Product information is subject to change without prior notice.

Dimensions	210 x 41 x 160 mm
Weight	0.73 kg
Power supply	Input: 100-240V~ 50/60Hz Output: DC 9V $\overline{=}$ 0.8A
Power consumption	9 W
Operating temperature range	0-45°C
Laser wavelength	650 nm
Video output	
Format	PAL & NTSC
Output level	1V _p - p \pm 20%
Load impedance	75 Ω
Audio line out	
Audio out (analog audio)	Output level: 2V \pm 10%
Load impedance	10 K Ω
Audio distortion + noise	\leq -80 (1KHz)
Frequency response	20Hz-20KHz \pm 1dB
Signal/noise ratio	\geq 80 dB
Channel separation	\geq 80 dB
Dynamic range	\geq 80 dB

7 Troubleshooting



Warning

- Risk of electric shock. Never remove the casing of the player.

To keep the warranty valid, never try to repair the system yourself. If you encounter problems when using the player, check the following points before requesting service. If the problem remains unsolved, register your player and get support at www.philips.com/welcome.

No power

- Ensure that both plugs of the mains cord are properly connected.
- Ensure that there is power at the AC outlet.
- Check if the built-in battery is drained.

No sound

- Ensure that the AV cable is connected correctly.

Distorted picture

- Clean the disc. With a clean, soft, lint-free cloth, wipe the disc outwards from the center.
- Make sure that the video output format of the disc is compatible with the TV.
- Change the video output format to match your TV or program.
- The LCD is manufactured using high precision technology. You may, however, see tiny black points and/or bright points (red, blue, green) that continuously appear on the LCD. This is a normal result of the manufacturing process and does not indicate a malfunction.

Cannot play disc

- Ensure the disc label is upwards.
- Clean the disc. With a clean, soft, lint-free cloth, wipe the disc outwards from the center.
- Check if the disc is defective by trying another disc.

No response to the remote control

- Ensure that the path between the remote control and the player is clear from obstacles.
- From a close distance, point the remote control directly at the player.
- Replace the remote control batteries.
- The function does not work for this disc. Refer to the disc instructions.

The player feels warm

- When the player is in use for a long period of time, its surface will be heated. This is normal.



© 2010 Koninklijke Philips Electronics N.V.
All rights reserved.
PD7040_05_UM_V1.0

