

Always there to help you

Register your product and get support at
www.philips.com/welcome



HTB3520

HTB3550

HTB3580

Quick start guide

PHILIPS



Before using your product, read all accompanying safety information



HTB3520

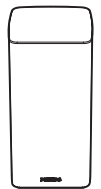
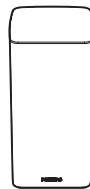
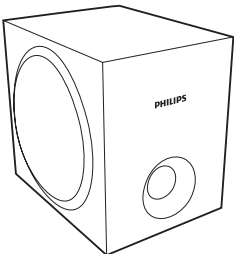
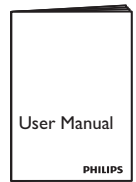
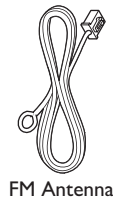
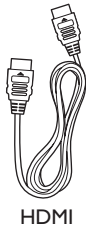
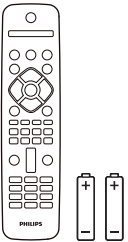
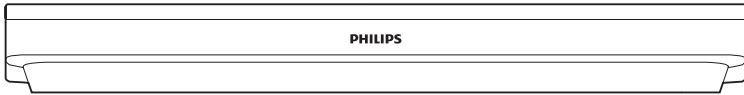

HTB3550

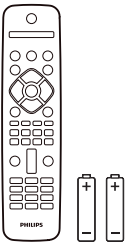
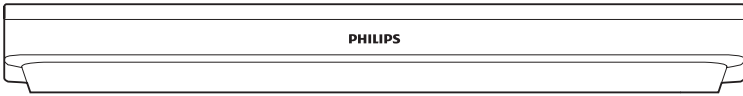

HDMI

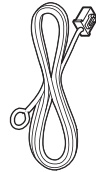

FM Antenna

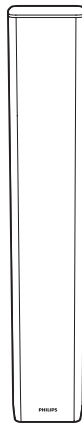
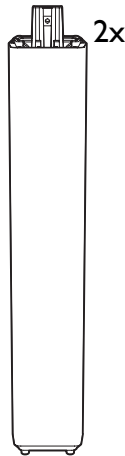
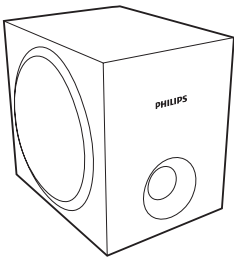
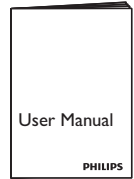

2x



8x



2x

2x

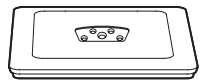

HTB3580

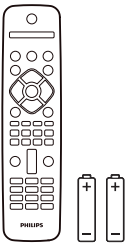

HDMI



FM Antenna

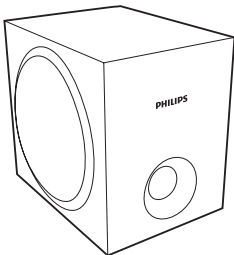
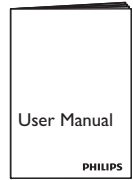

4x

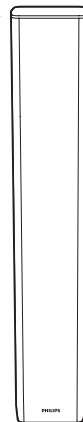

4x



16x



4x

4x

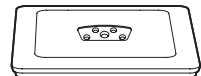

1

Stand mount the speakers
Applied to HTB3550 and HTB3580 only

1

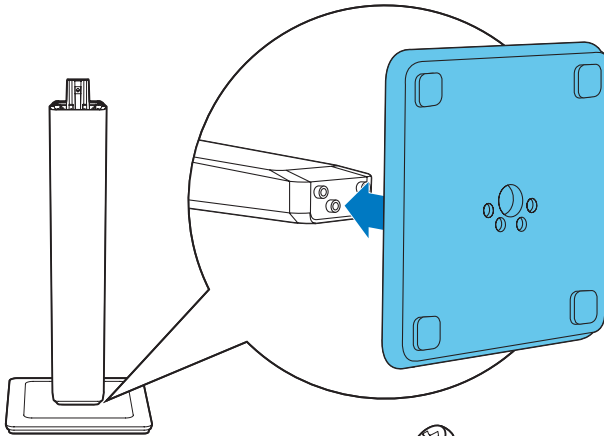

2

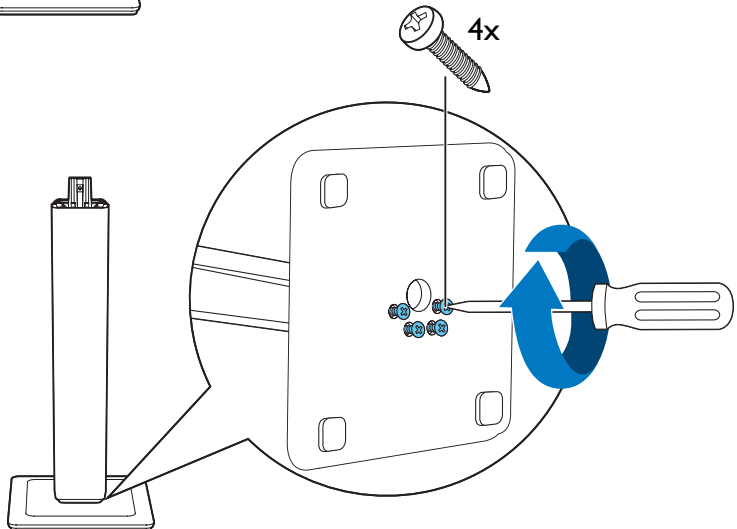

3

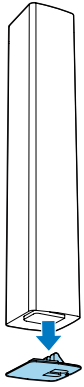

4

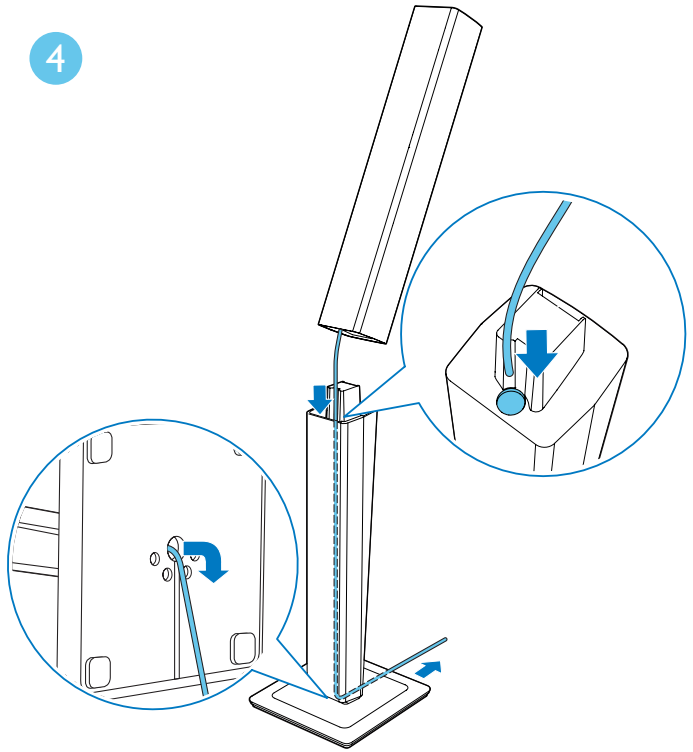

5

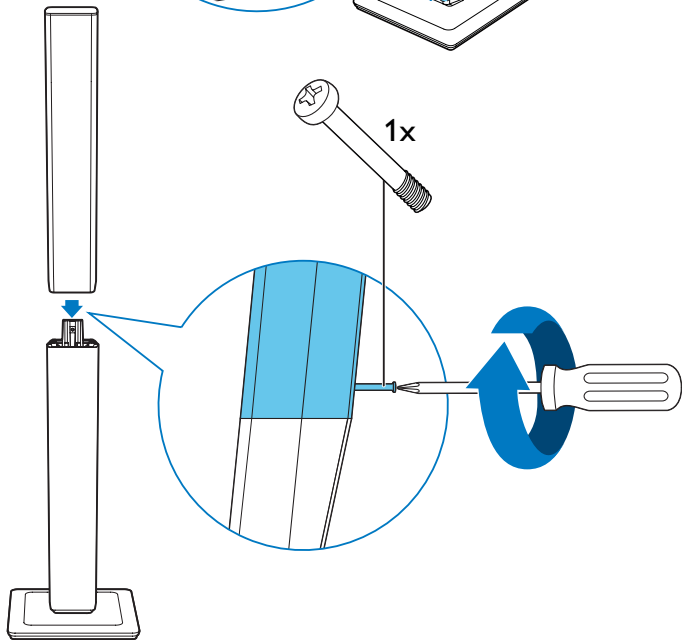

2

Connect and position the home theater

HTB3520

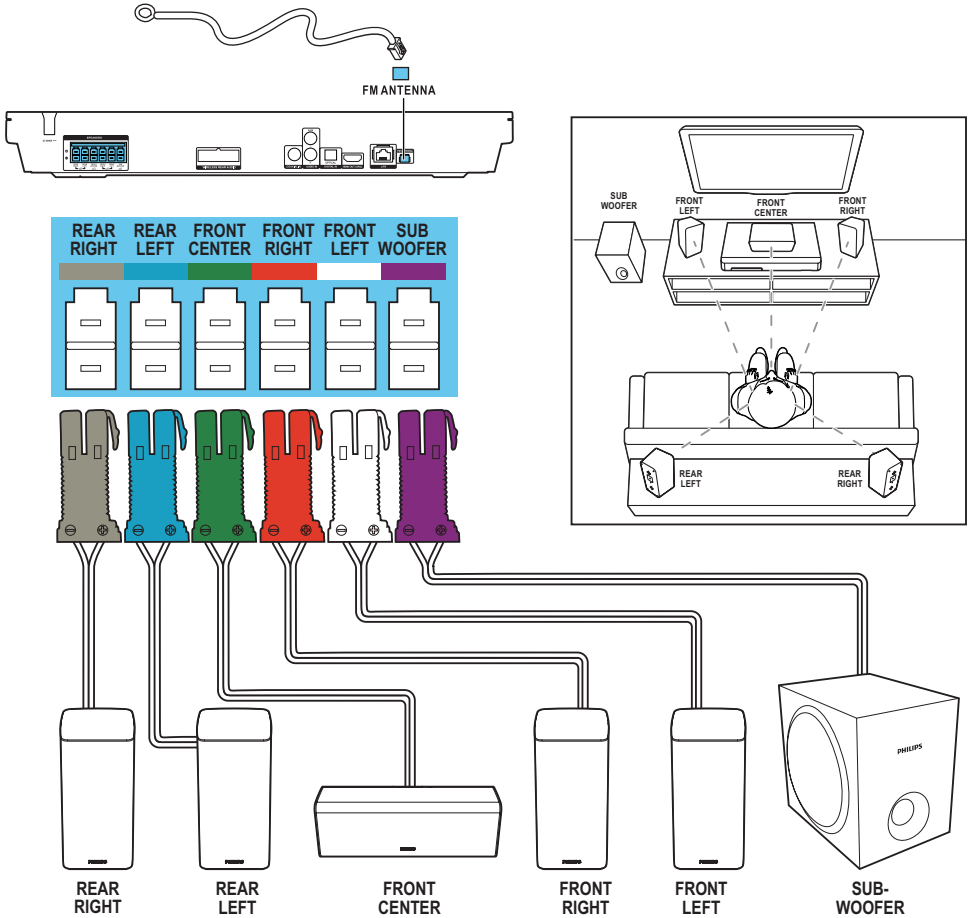

HTB3550

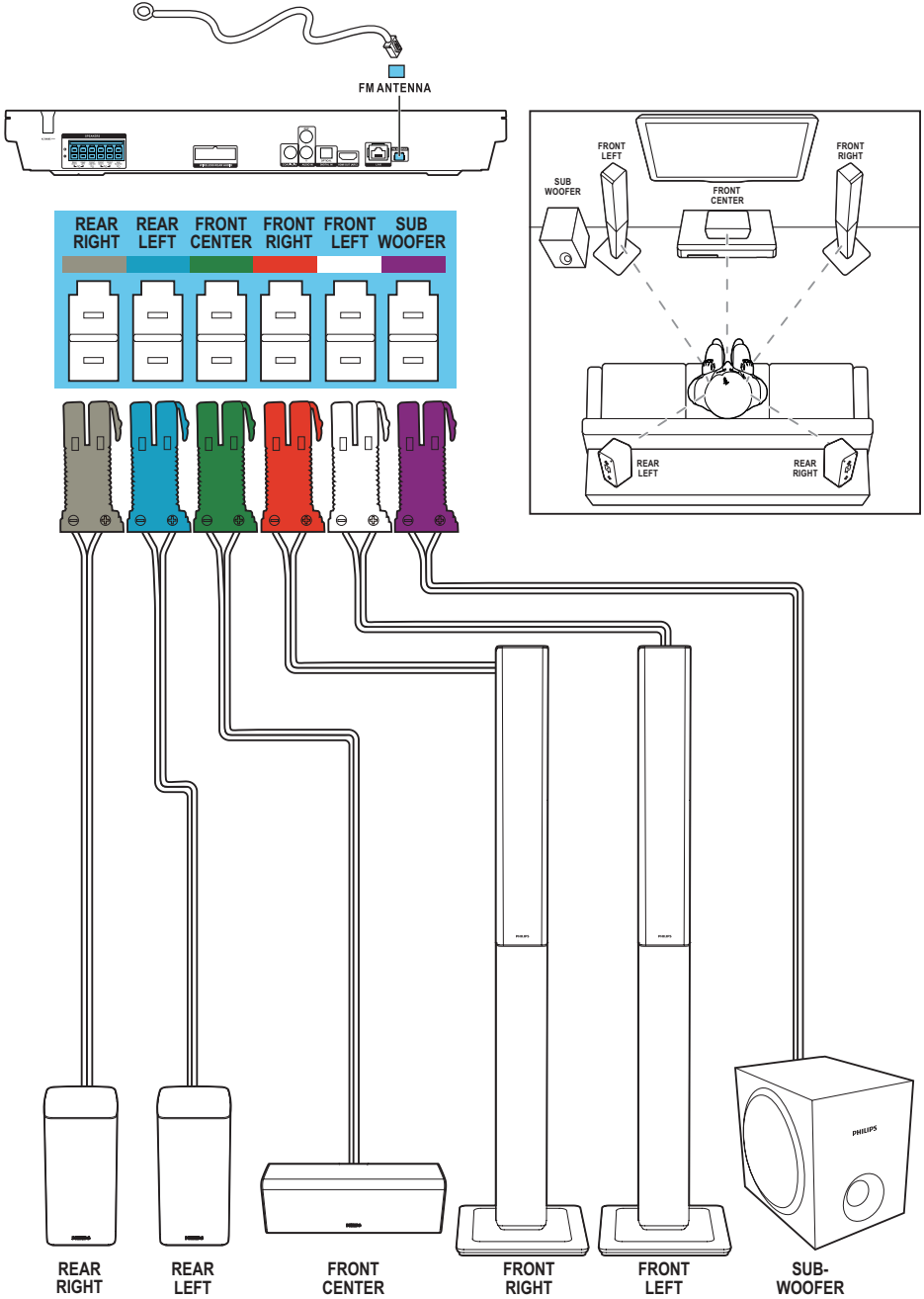

HTB3580

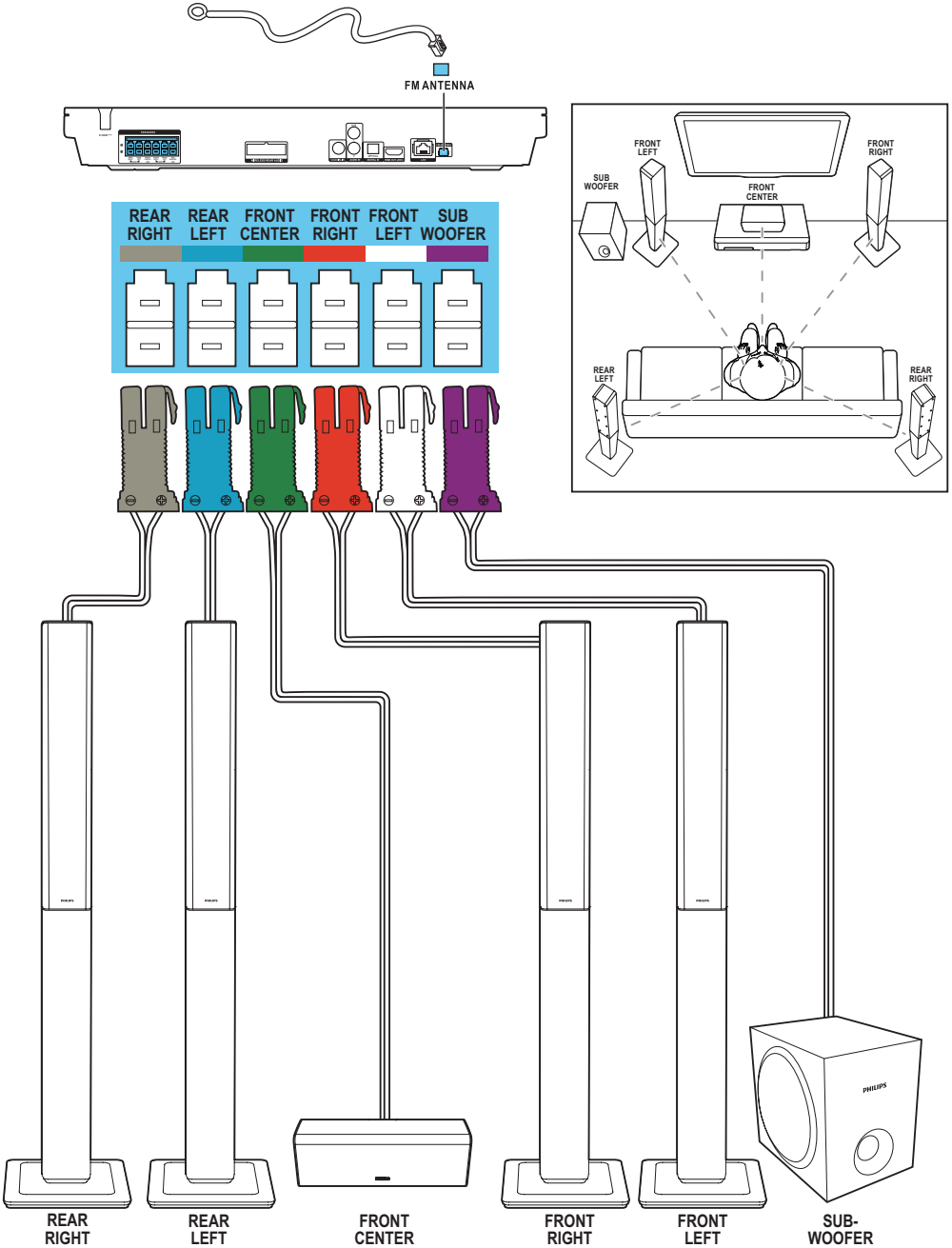

3

Connect to TV in one of these ways

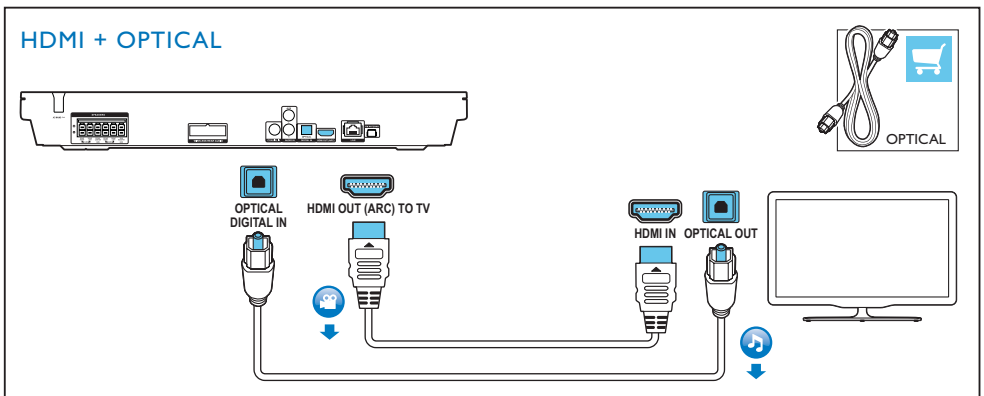
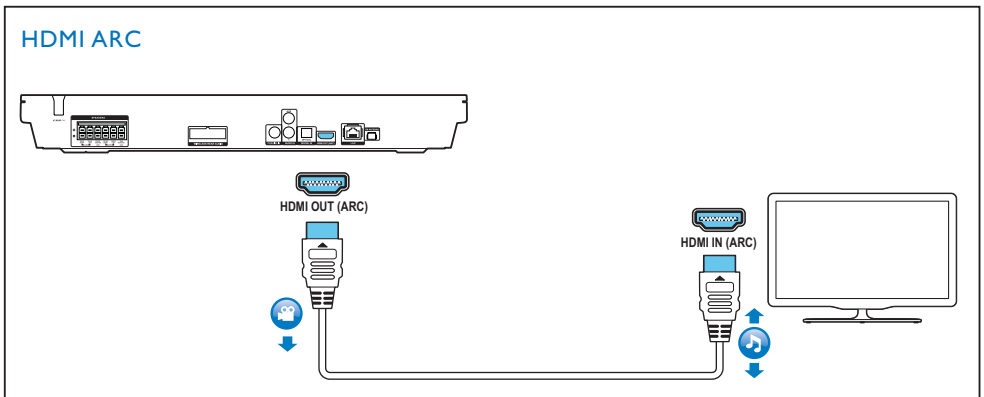

HDMI + COAXIAL

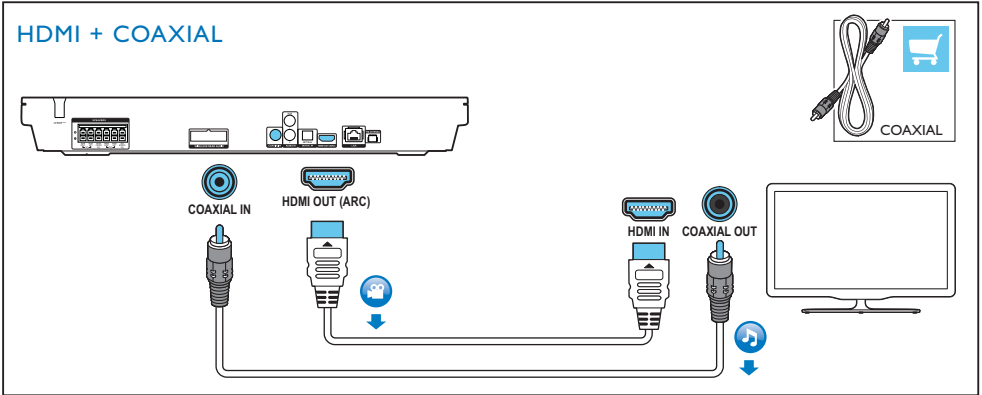

HDMI + AUDIO L/R

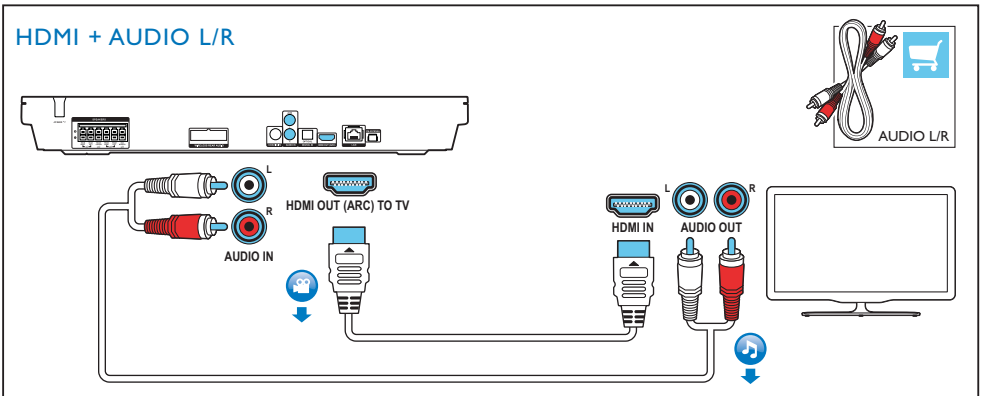

4

Switch on the home theater

1

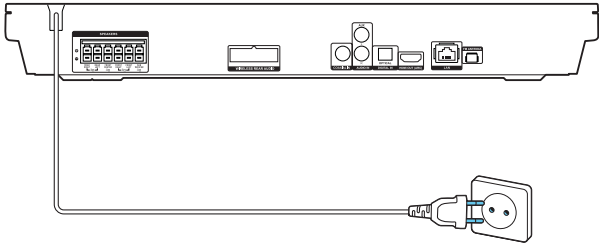

2

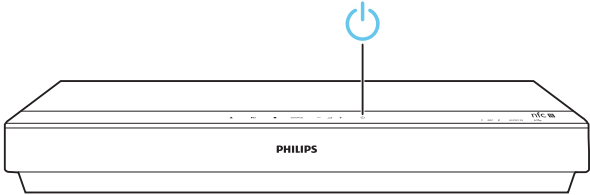

3

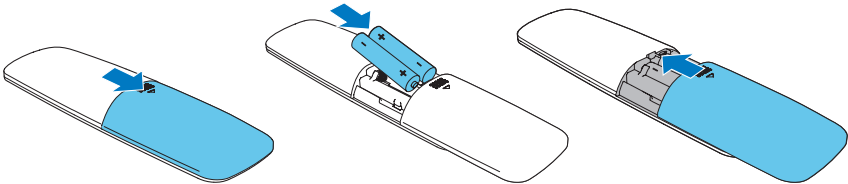

5

Complete the first time setup

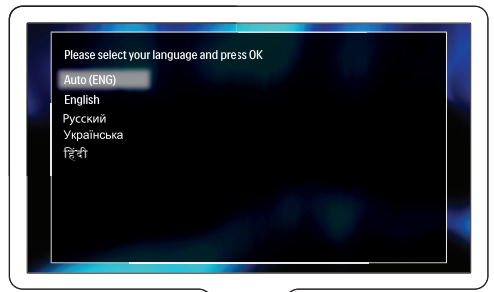
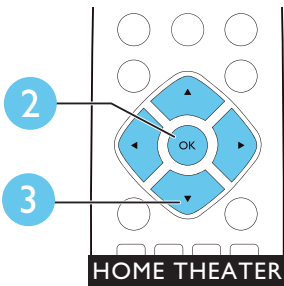
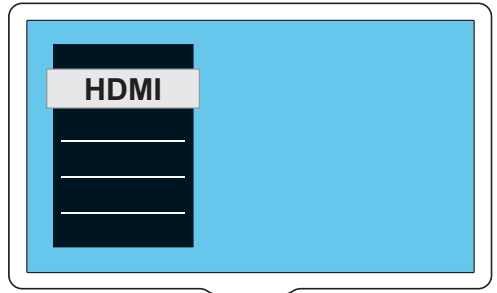
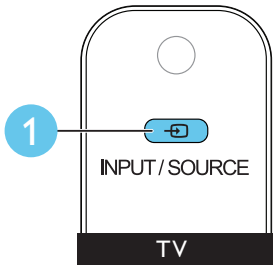

6

Use your home theater

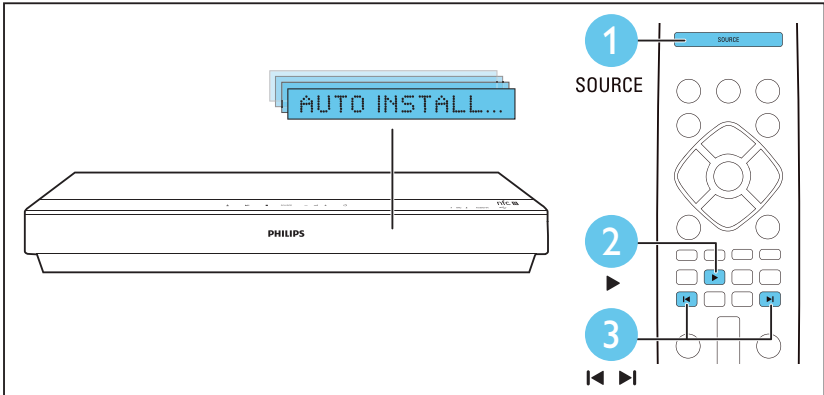
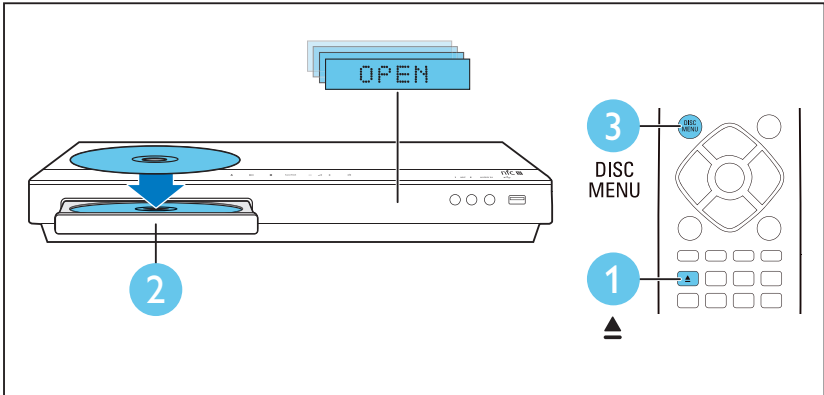

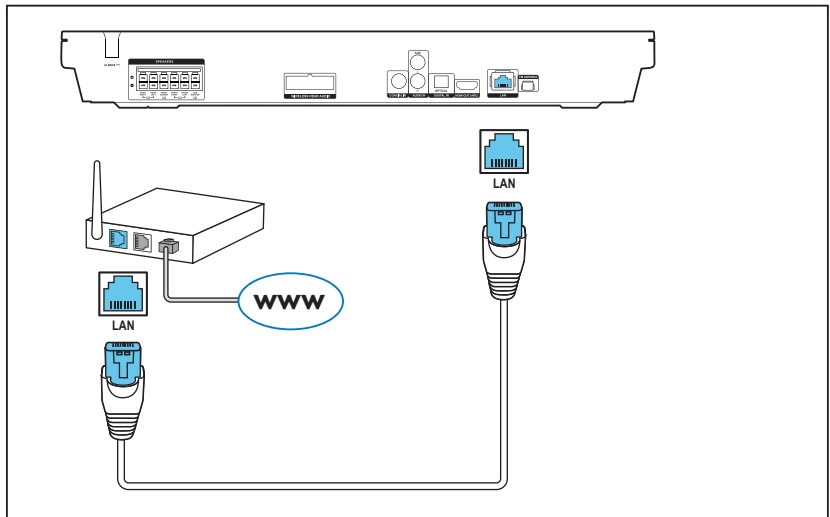
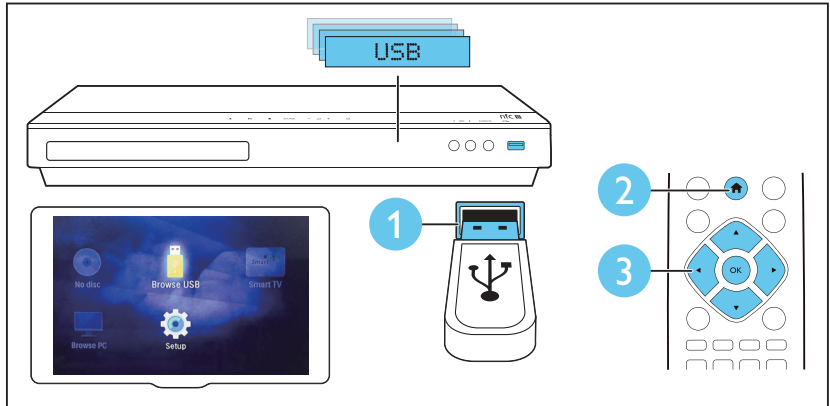
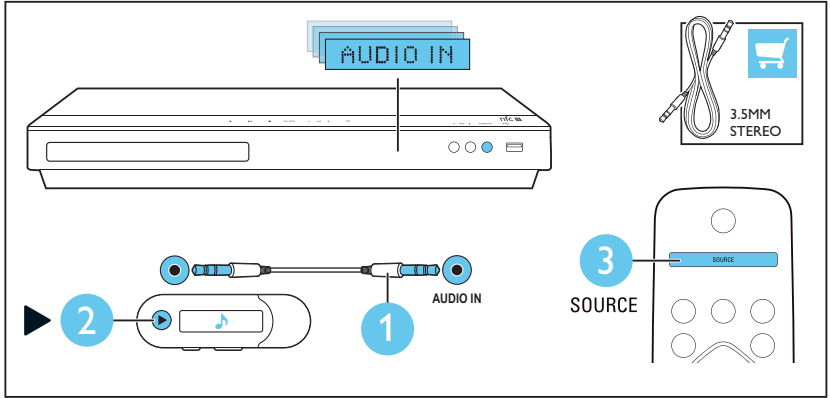

7

Play audio through Bluetooth or connect Bluetooth via NFC

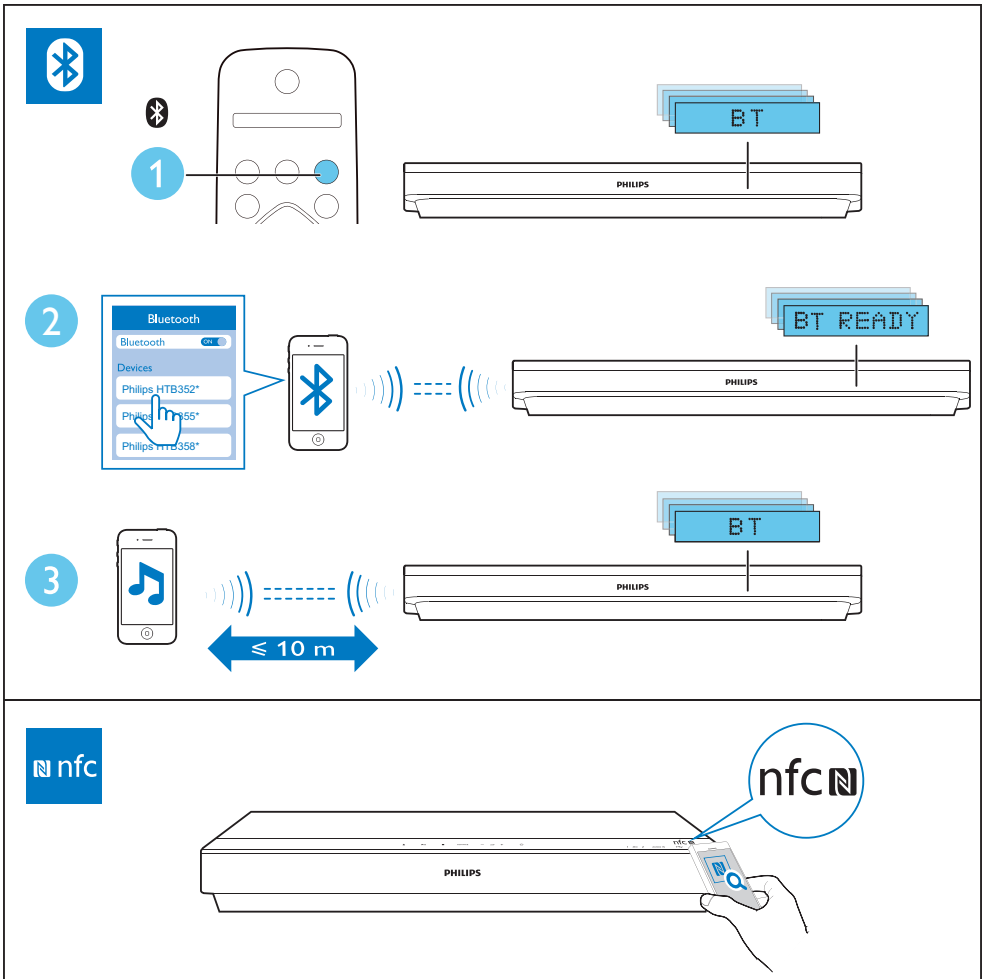



For more information about using this product, visit www.philips.com/support



www.philips.com/support



Specifications are subject to change without notice

© 2015 Koninklijke Philips N.V. All rights reserved.

Trademarks are the property of Koninklijke Philips N.V. or their respective owners.

HTB3520/3550/3580_94_QSG_V2.0

