

Quick Start Guide



Step A Setup

Step B Enjoy

What's in the Box?

You should find these items upon opening the box.

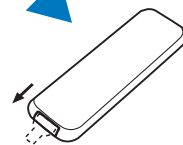
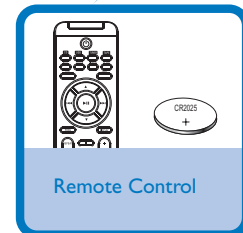
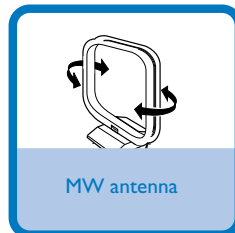
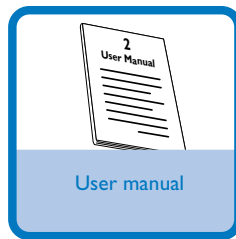
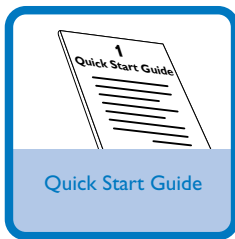

Pull out the insulation plastic sheet.

PHILIPS

Connection

- 1 For radio reception, connect the supplied MW antenna to the **MW aerial** terminal.
- 2 Connect the speaker wires to the **SPEAKERS** terminals.
- 3 Connect the power cord of the system to the AC power outlet.

Tip:

It is unnecessary to connect the FM pigtail antenna since it is fixed to the main unit.

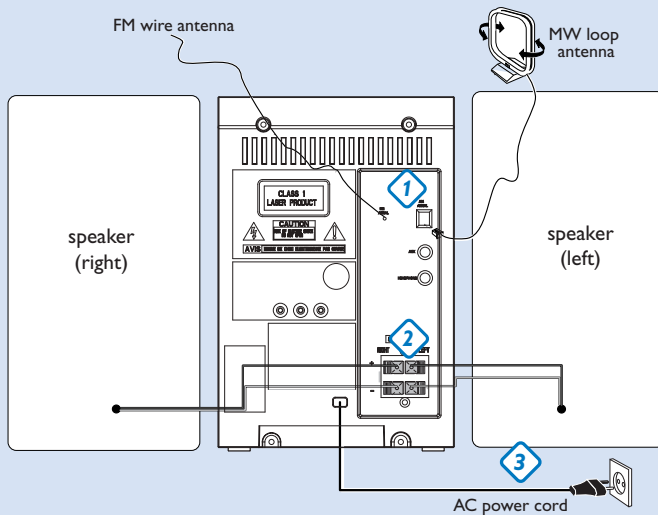

Setting the clock

- 1 In standby mode, press and hold **DISPLAY/CLOCK** (**CLOCK** on the remote control) for 2 seconds. The clock digits for the hours flash.
- 2 Press **TUNING** \lll / \ggg to set the hours.
- 3 Press **DISPLAY/CLOCK** again. The clock digits for the minutes flash.
- 4 Press **TUNING** \lll / \ggg to set the minutes.
- 5 Press **DISPLAY/CLOCK** to confirm the time.

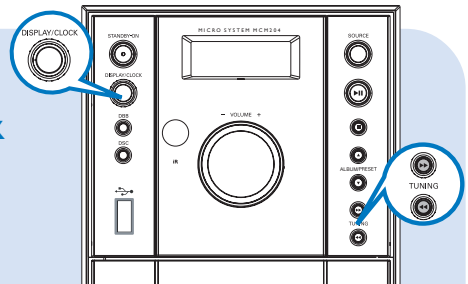

Step B

Enjoy

Playing a disc

- 1 Select **CD** source.
- 2 Press **OPEN/CLOSE** on the top of the system to open the CD door.
- 3 Insert a disc with the printed side facing up and press down on **OPEN/CLOSE** to close the CD door.
- 4 Press **▶ ||** to start playback.
- 5 Press **■** to stop playback.

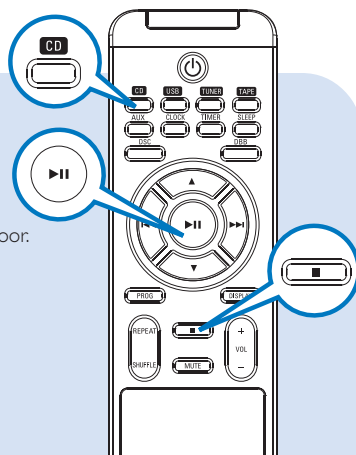

Programming and tuning to radio stations

- 1 Select **TUNER** source.
- 2 Press **PROG** on the remote control for more than two seconds to program all available stations in order of waveband.
- 3 Press **ALBUM/PRESET ▼ ▲** until the desired preset station is displayed.





Tip:

Detailed playback features and additional functions are described in the accompanied owner's manual.

Notes for the remote control:

- First, select the source you wish to control by pressing one of the source select keys on the remote control (DISC or AUX, for example).
- Then select the desired function (▶ ||, ◀, ▶ for example).

Playing a USB mass storage device

- 1 Make sure that your MCM204 is being powered on.
- 2 Press **SOURCE** repeatedly (or **USB** on the remote) to enter USB mode.
The LCD display shows - - - with USB DIRECT.
- 3 Plug a compatible USB mass storage device to MCM204's USB port marked  .
If needed, use a suitable USB cable to connect between the device and MCM204's USB port.
The device will automatically power on.
- 4 Press   on your MCM204 to start playback.
- 5 Press  to stop playback.

Tip:

Refer to the user manual supplied for the description about compatibility of USB mass storage device, and playability of the files stored on the USB device.

