

Register your product and get support at
www.philips.com/welcome

DCD8000



EN	User manual	3
ZH-CN	用户手册	33

PHILIPS

DEMO MODE

To turn ON

Press



button

To turn OFF

Press



button

PLUG & PLAY -for tuner installation

1



Plug in the unit

2



Follow instructions
in the display

3



Press

button

Contents

1 Important	4
Safety	4
Notice	6
2 Your DVD Micro Theater	7
Introduction	7
What's in the box	8
Overview of the main unit	9
Overview of the remote control	10
3 Connect	11
Place the unit	11
Connect control cable	12
Connect speakers	12
Connect FM antenna	13
Connect video/audio cables	13
Route audio from other devices	15
Connect power	15
4 Get started	16
Prepare the remote control	16
Turn on	17
Set clock	17
Adjust brightness of display panel	17
Turn on or off LED light	17
Store radio stations automatically	17
Find the correct viewing channel	17
Select the correct TV system	18
Change system menu language	18
5 Play	18
Play a disc	18
Play from USB or recored discs	19
Play a slideshow with background music	20
Play control	20
Play options	20
Picture view options	21
6 Play iPod/iPhone/iPad	21
Compatible iPod/iPhone/iPad	21
Load the iPod/iPhone/iPad	22
Play audio from the iPod/iPhone/iPad	22
Charge the iPod/iPhone/iPad	22
Remove the iPod/iPhone/iPad	22
7 Listen to radio	22
Tune to a radio station	22
Program radio stations automatically	22
Program radio stations manually	23
Tune to a preset radio station	23
8 Adjust sound	23
Adjust volume level	23
Select a sound effect	23
Mute sound	23
9 Adjust settings	24
General setup	24
Audio setup	24
Video setup	25
Preferences	26
10 Other features	27
Activate demonstration mode	27
Set alarm timer	27
Set the sleep timer	28
Listen to an audio device	28
Listen through headphone	28
11 Product information	29
Specifications	29
Supported disc formats	30
USB playability information	30
12 Troubleshooting	31

1 Important

Safety

Know these safety symbols



This 'bolt of lightning' indicates uninsulated material within your unit may cause an electrical shock. For the safety of everyone in your household, please do not remove product covering.

The 'exclamation point' calls attention to features for which you should read the enclosed literature closely to prevent operating and maintenance problems. **WARNING:** To reduce the risk of fire or electric shock, this apparatus should not be exposed to rain or moisture and objects filled with liquids, such as vases, should not be placed on this apparatus.

CAUTION: To prevent electric shock, match wide blade of plug to wide slot, fully insert.

Important Safety Instructions

- ① Read these instructions.
- ② Keep these instructions.
- ③ Heed all warnings.
- ④ Follow all instructions.
- ⑤ Do not use this apparatus near water.
- ⑥ Clean only with dry cloth.
- ⑦ Do not block any ventilation openings. Install in accordance with the manufacturer's instructions.
- ⑧ Do not install near any heat sources such as radiators, heat registers, stoves, or other apparatus (including amplifiers) that produce heat.
- ⑨ Protect the power cord from being walked on or pinched, particularly at plugs, convenience receptacles, and the point where they exit from the apparatus.
- ⑩ Only use attachments/accessories specified by the manufacturer.
- ⑪ Use only with the cart, stand, tripod, bracket, or table specified by the manufacturer or sold with the apparatus. When a cart is used, use caution when moving the cart/apparatus combination to avoid injury from tip-over.
- ⑫ Unplug this apparatus during lightning storms or when unused for long periods of time.
- ⑬ Refer all servicing to qualified service personnel. Servicing is required when the apparatus has been damaged in any way, such as power-supply cord or plug is damaged, liquid has been spilled or objects have fallen into the apparatus, the apparatus has been exposed to rain or moisture, does not operate normally, or has been dropped.
- ⑭ Battery usage CAUTION – To prevent battery leakage which may result in bodily injury, property damage, or damage to the unit:



- Install all batteries correctly, + and - as marked on the unit.
- Do not mix batteries (old and new or carbon and alkaline, etc.).
- Remove batteries when the unit is not used for a long time.

- ⑮ **Apparatus shall not be exposed to dripping or splashing.**
- ⑯ **Do not place any sources of danger on the apparatus (e.g. liquid filled objects, lighted candles).**
- ⑰ **Where the MAINS plug or an appliance coupler is used as the disconnect device, the disconnect device shall remain readily operable.**

Risk of overheating! Never install this apparatus in a confined space. Always leave a space of at least four inches around this apparatus for ventilation. Ensure curtains or other objects never cover the ventilation slots on this apparatus.



Caution

- Use of controls or adjustments or performance of procedures other than herein may result in hazardous radiation exposure or other unsafe operation.



Warning

- Never remove the casing of this unit.
- Never lubricate any part of this unit.
- Place this unit on a flat, hard and stable surface.
- Never place this unit on other electrical equipment.
- Only use this unit indoors. Keep this unit away from water, moisture and liquid-filled objects.
- Keep this unit away from direct sunlight, naked flames or heat.
- Never look into the laser beam inside the unit.

Hearing safety

Listen at a moderate volume.

- Using headphones at a high volume can impair your hearing. This product can produce sounds in decibel ranges that may cause hearing loss for a normal

person, even for exposure less than a minute. The higher decibel ranges are offered for those that may have already experienced some hearing loss.

- Sound can be deceiving. Over time your hearing 'comfort level' adapts to higher volumes of sound. So after prolonged listening, what sounds 'normal' can actually be loud and harmful to your hearing. To guard against this, set your volume to a safe level before your hearing adapts and leave it there.

To establish a safe volume level:

- Set your volume control at a low setting.
- Slowly increase the sound until you can hear it comfortably and clearly, without distortion.

Listen for reasonable periods of time:

- Prolonged exposure to sound, even at normally 'safe' levels, can also cause hearing loss.
- Be sure to use your equipment reasonably and take appropriate breaks.

Be sure to observe the following guidelines when using your headphones.

- Listen at reasonable volumes for reasonable periods of time.
- Be careful not to adjust the volume as your hearing adapts.
- Do not turn up the volume so high that you can't hear what's around you.
- You should use caution or temporarily discontinue use in potentially hazardous situations. Do not use headphones while operating a motorized vehicle, cycling, skateboarding, etc.; it may create a traffic hazard and is illegal in many areas.

Notice

Any changes or modifications made to this device that are not expressly approved by Philips Consumer Lifestyle may void the user's authority to operate the equipment.



Your product is designed and manufactured with high quality materials and components, which can be recycled and reused.



When this crossed-out wheeled bin symbol is attached to a product it means that the product is covered by the European Directive 2002/96/EC. Please inform yourself about the local separate collection system for electrical and electronic products. Please act according to your local rules and do not dispose of your old products with your normal household waste. Correct disposal of your old product helps to prevent potential negative consequences for the environment and human health.



Your product contains batteries covered by the European Directive 2006/66/EC, which cannot be disposed with normal household waste. Please inform yourself about the local rules on separate collection of batteries because correct disposal helps to prevent negative consequences for the environmental and human health.

Environmental information

All unnecessary packaging has been omitted. We have tried to make the packaging easy to separate into three materials: cardboard (box),

polystyrene foam (buffer) and polyethylene (bags, protective foam sheet.) Your system consists of materials which can be recycled and reused if disassembled by a specialized company. Please observe the local regulations regarding the disposal of packaging materials, exhausted batteries and old equipment.

Copyright notice

 **Be responsible
Respect copyrights**

This item incorporates copy protection technology that is protected by U.S. patents and other intellectual property rights of Rovi Corporation. Reverse engineering and disassembly are prohibited.

Trademark notice

Made for
 iPod  iPhone  iPad

"Made for iPod," "Made for iPhone," and "Made for iPad" mean that an electronic accessory has been designed to connect specifically to iPod, iPhone, or iPad, respectively, and has been certified by the developer to meet Apple performance standards. Apple is not responsible for the operation of this device or its compliance with safety and regulatory standards. Please note that the use of this accessory with iPod, iPhone, or iPad may affect wireless performance. iPod and iPhone are trademarks of Apple Inc., registered in the U.S. and other countries. iPad is a trademark of Apple Inc.



HDMI, and HDMI logo, and High-Definition Multimedia Interface are trademarks or registered trademarks of HDMI licensing LLC in the United States and other countries.



'DVD Video' is a trademark of DVD Format/Logo Licensing Corporation.



Manufactured under license from Dolby Laboratories. Dolby and the double-D symbol are trademarks of Dolby Laboratories.



ABOUT DIVX VIDEO: DivX® is a digital video format created by DivX, Inc. This is an official DivX Certified device that plays DivX video. Visit www.divx.com for more information and software tools to convert your files into DivX video.

ABOUT DIVX VIDEO-ON-DEMAND: This DivX Certified® device must be registered in order to play DivX Video-on-Demand (VOD) content. To generate the registration code, locate the DivX VOD section in the device setup menu. Go to vod.divx.com with this code to complete the registration process and learn more about DivX VOD.

DivX®, DivX Certified® and associated logos are registered trademarks of DivX, Inc. and are used under license.

This apparatus includes this label:



Note

- The type plate is located on the bottom of the apparatus.

2 Your DVD Micro Theater

Congratulations on your purchase, and welcome to Philips! To fully benefit from the support that Philips offers, register your product at www.philips.com/welcome.

Introduction

With this unit, you can:

- Watch video from DVD/VCD/SVCD or USB storage devices
- Enjoy audio from discs, iPod/iPhone/iPad, or USB storage devices
- View pictures from discs or USB storage devices
- Listen to FM radio

You can enrich sound output with these sound effects:

- Bass/treble enhancement
- Automatic loudness control (LOUDNESS)

The unit supports these media/disc formats:



You can play DVD discs marked with the following region code:

DVD region code	Countries
	China

What's in the box

Check and identify the contents of your package:

- Main unit (DVD unit + amplifier)
- 2 speakers
- 2 x speaker cables
- Remote control with batteries
- Composite video cable
- Composite audio cables
- MP3 link cable
- Power cord
- FM wire antenna
- User manual

Overview of the main unit

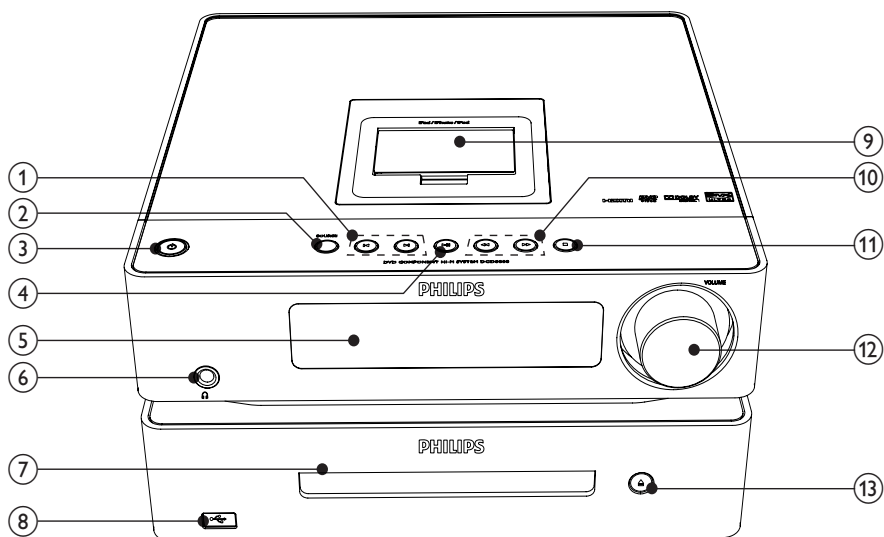

- ① **⏮ / ⏭**
 - Skip to the previous/next track, title, or chapter.
 - Select a preset radio station.
- ② **SOURCE**
 - Select a source.
- ③ **⏻**
 - Turn on or off the unit.
- ④ **▶ ||**
 - Start or pause play.
- ⑤ **Display panel**
 - Display current status.
- ⑥ **🎧**
 - Headphone socket.
- ⑦ **Disc compartment**
- ⑧ **🔌**
 - USB socket.
- ⑨ **Dock for iPod/iPhone/iPad**
- ⑩ **⏮ / ⏭**
 - Search in a track or disc.
 - For menus, navigate left/right.
 - Tune to a radio station.
 - Rotate a picture.
- ⑪ **■**
 - Stop play or erase a program.
- ⑫ **VOLUME**
 - Adjust volume.
 - Adjust time.
- ⑬ **▲**
 - Open or close the disc compartment.

Overview of the remote control

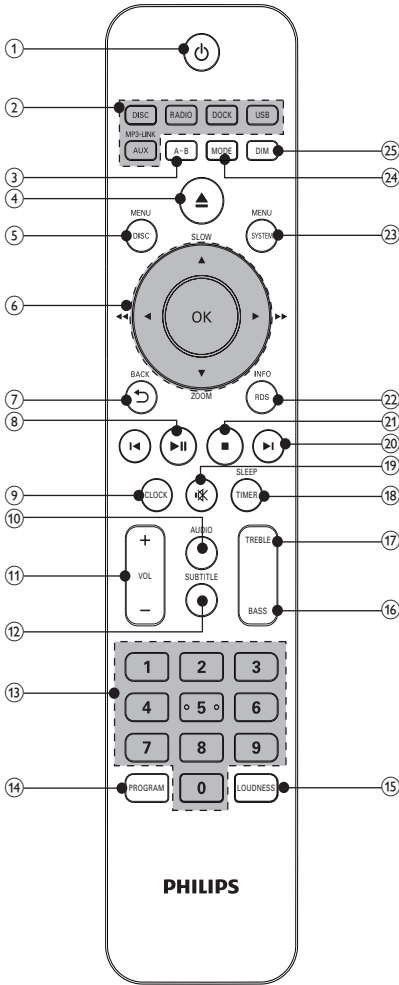

- ① **Power**
 - Turn on or off the unit.
- ② **Source selection keys**
 - Select a source.
- ③ **A-B**
 - Repeat a specific section within a track/chapter.

- ④ **▲**
 - Open or close the disc compartment.
- ⑤ **DISC MENU**
 - For video discs: access or exit the disc menu.
 - For video discs with playback control(PBC): turn on/off PBC.
- ⑥ **Navigation keys**
 - ▲ **SLOW/ ▼ ZOOM**
 - For menus: navigate up/down.
 - Invert a picture.
 - (▲ **SLOW**) For video: select a slow backward mode.
 - (▼ **ZOOM**) For video: (hold) zoom in/out; (press) select a slow forward mode.
 - ◀/▶ (◀◀/▶▶)
 - Search in a track or disc.
 - For menus, navigate left/right.
 - Tune to a radio station.
 - Rotate a picture.
 - OK**
 - Confirm a selection.
 - Switch between FM stereo and mono broadcast.
- ⑦ **↶ BACK**
 - Return to the previous menu.
- ⑧ **▶▶**
 - Start or pause play.
- ⑨ **CLOCK**
 - Set the clock.
 - View the clock.
- ⑩ **AUDIO**
 - For VCD, select stereo, mono-left or mono-right channel.
 - For DVD/DivX video, select an audio language.
- ⑪ **VOL +/-**
 - Adjust volume.
 - Adjust time.
 - Adjust the bass/treble level.
- ⑫ **SUBTITLE**
 - Select a subtitle language.

- ⑬ **Numeric keypad**
 - Select a title/chapter/track.
- ⑭ **PROGRAM**
 - Program radio stations.
- ⑮ **LOUDNESS**
 - Turn on or off loudness control.
- ⑯ **BASS**
 - Enable bass adjustment.
- ⑰ **TREBLE**
 - Enable treble adjustment.
- ⑱ **SLEEP/TIMER**
 - Set the sleep timer.
 - Set the alarm timer.
- ⑲ **🔇**
 - Mute or restore volume.
- ⑳ **⏮ / ⏭**
 - Skip to the previous/next track.
 - Skip to the previous/next title or chapter.
 - Select a preset radio station.
- ㉑ **■**
 - Stop play.
 - Erase a program.
- ㉒ **INFO/RDS (RDS function unavailable for this version)**
 - Display play information on a connected TV.
- ㉓ **SYSTEM MENU**
 - Access or exit the system setup menu.
- ㉔ **MODE**
 - Select repeat/shuffle play modes.
- ㉕ **DIM**
 - Select a brightness level for the display screen.
 - (Press and hold) turn on or off the LED light at the bottom of the unit and at the volume knob.

3 Connect

Place the unit

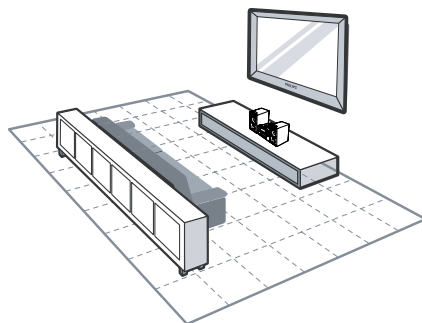

- 1 Place the unit near to the TV.
- 2 Place the left and right speakers at equal distance from the TV and at an angle of approximately 45 degrees from the listening position.

Note

- To avoid magnetic interference or unwanted noise, never place this apparatus and speakers too close to any radiation devices.
- Place this unit on top of a table or mount it on the wall.
- Never place this unit in an enclosed cabinet.
- Install this unit near the AC outlet where the AC power plug can be easily reached.

Connect control cable

- Connect the control cable connector from the back of the DVD unit to the **CONTROL CABLE** jack on the back of the amplifier.

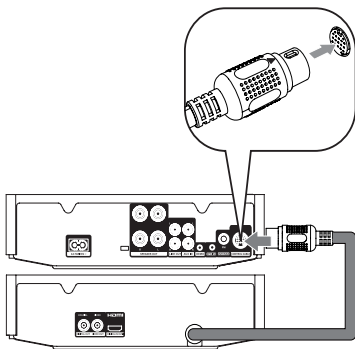

Connect speakers

Note

- Insert the stripped portion of each speaker wire into the socket completely.
- For optimal sound, use the supplied speakers only.
- Connect only speakers with impedance that is the same or higher than the supplied speakers.
- The **DEMO** jack is only applicable to the demo unit that is not included in the apparatus. Do not attempt to connect any other device to the apparatus through this jack.

For the main unit side:

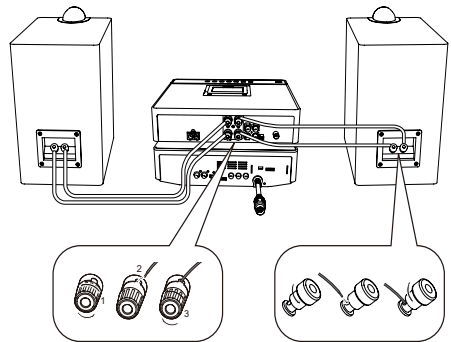

- 1 Unscrew the speaker connectors.
- 2 Insert fully the red end of a speaker cable into the left red (+) connector.
- 3 Screw the left red (+) connector to secure the cable.
- 4 Insert fully the silver end of a speaker cable into the left black (-) connector.
- 5 Screw the left black (-) connector to secure the cable.
- 6 Repeat steps 2-5 to insert the other speaker cable into the right connectors.

For the speaker side:

- 1 Unscrew the speaker connectors.
- 2 For the left speaker, identify the speaker cable that is connected to the left connectors on the main unit.
- 3 Insert fully the red end of the speaker cable into the red (+) connector.
- 4 Screw the red (+) connector to secure the cable.
- 5 Insert fully the silver end of the speaker cable into the black (-) connector.
- 6 Screw the black (-) connector to secure the cable.
- 7 Repeat steps 2-6 for the right speaker.

Connect FM antenna

Tip

- For optimal reception, fully extend and adjust the position of the antenna.
 - For better FM stereo reception, connect an outdoor FM antenna to the **FM ANTENNA** socket.
 - The unit does not support MW radio reception.
- Connect the supplied FM wire antenna to the **FM ANTENNA** socket on the unit.

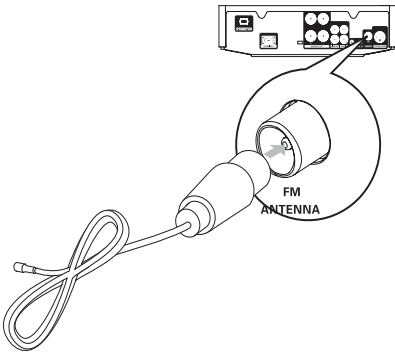

Connect video/audio cables

Select the best video connection that the TV can support.

- **Option 1:** Connect to the HDMI jack (for an HDMI, DVI or HDCP-compliant TV).
- **Option 2:** Connect to the composite video jack (for a standard TV).

Option 1: Connect to the HDMI jack

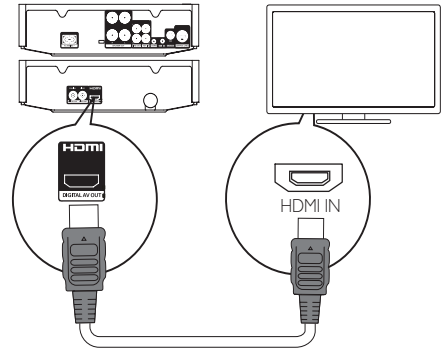

- 1 Connect an HDMI cable (not supplied) to:
 - the **HDMI (DIGITAL AV OUT)** jack on this product.
 - the **HDMI** input jack on the TV.

Tip

- If the TV has a DVI connector only, connect via an HDMI/DVI adaptor. Connect an audio cable for sound output.
- If this product connects to a TV compatible with 1080p or 1080p/24Hz, Philips recommends HDMI category 2 cable, also known as High Speed HDMI cable, for optimal video and audio output.
- This type of connection provides the best picture quality.

Option 2: Connect to the composite video jack

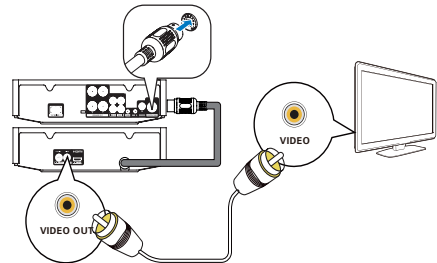

- 1 Connect a composite video cable to:
 - the **VIDEO (VIDEO OUT)** jack on this unit.
 - the VIDEO input jack on the TV.
- 2 Connect the audio cables to:
 - the **LINE OUT-L/R** jacks on this unit.
 - the AUDIO input jacks on the TV.

 **Tip**

- The video input jack on the TV might be labeled as A/V IN, VIDEO IN, COMPOSITE or BASEBAND.

Route audio to other devices

You can route the audio from this product to other devices.

Connect to an HDMI-compliant AV receiver/amplifier

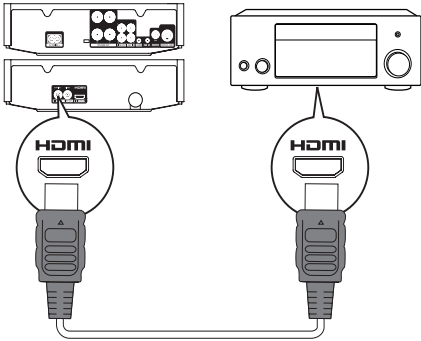

- 1 Connect an HDMI cable (not supplied) to:
 - the **HDMI (DIGITAL AV OUT)** jack on this unit.
 - the HDMI jack input jack on the device.

 **Tip**

- The HDMI connection provides the best audio quality.

Connect to a digital AV amplifier/receiver

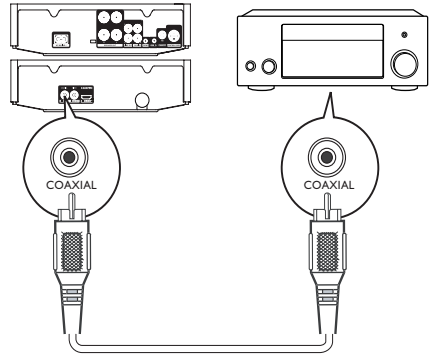

- 1 Connect a coaxial cable (not supplied) to:
 - the **COAXIAL (DIGITAL OUT)** jack on this unit.
 - the COAXIAL/DIGITAL input jack on the device.

Connect an analogue stereo system

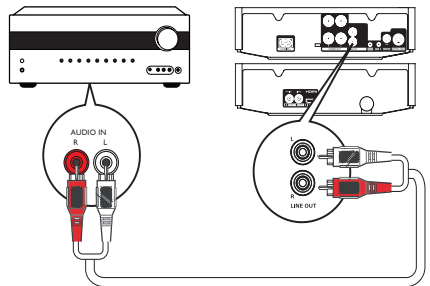

- 1 Connect the audio cables to:
 - the **LINE OUT-L/R** jacks on this unit.
 - the AUDIO input jacks on the device.

Route audio from other devices

Route audio from TV or other devices

Use this product to play audio from the TV or other device such as a cable box.

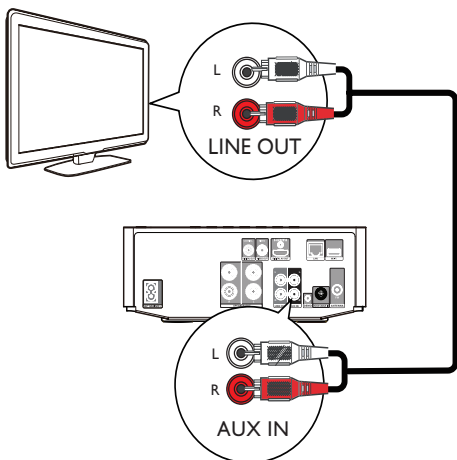

Tip

- Press **MP3 LINK/AUX** to select the audio output of your connection.

Listen to an audio player

You can listen to an audio player through this unit.

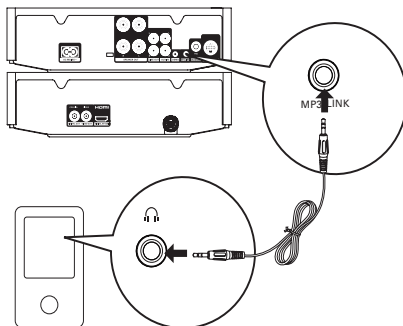

- Connect the supplied MP3 Link cable to the **MP3 LINK** socket and to the headphone socket on the audio player.

Tip

- Press **MP3 LINK/AUX** to select the audio output of your connection.

Connect power

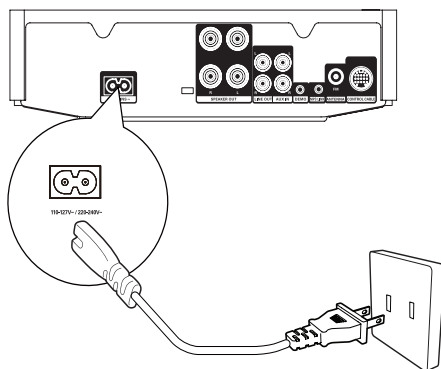



Caution

- Risk of product damage! Make sure that the power supply voltage corresponds to the voltage printed on the back or the underside of the unit.
 - Before connecting the AC power cord, make sure that you have completed all other connections.
- Connect the AC power cord to
- the **AC MAINS**~ socket on this unit.
 - the wall power socket.

4 Get started



Caution

- Use of controls or adjustments or performance of procedures other than herein may result in hazardous radiation exposure or other unsafe operation.

Always follow the instructions in this chapter in sequence.

If you contact Philips, you will be asked for the model and serial number of this apparatus. The model number and serial number are on the back of the apparatus. Write the numbers here:

Model No. _____

Serial No. _____

Prepare the remote control

- 1 Press and push the battery compartment to slide it open (see "1" in the illustration).
- 2 Insert two AAA batteries with correct polarity (+/-) as indicated.
- 3 Push and slide back the battery compartment (see "3" in the illustration).

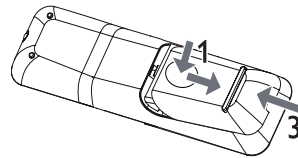

Note

- The batteries shall not be exposed to excessive heat such as sunshine, fire or the like.
- If you are not going to use the remote control for a long time, remove the batteries.
- Do not mix batteries (old and new or carbon and alkaline, etc.).
- Batteries contain chemical substances, so they should be disposed of properly.

Turn on

- 1 Press **⏻**.
↳ The unit switches to the last selected source.

Switch to standby mode

- 1 Press and hold **⏻** for over 3 seconds to switch the unit to Eco Power Standby mode.
↳ The backlight on the display panel turns off.
↳ The red Eco Power indicator turns on.

To switch the unit to standby mode:

- 1 In Eco Power Standby mode, press and hold **⏻** for over 3 seconds.
↳ The clock (if set) appears on the display panel.
↳ The red Eco Power indicator turns off.

Set clock

- 1 In standby mode, press and hold **CLOCK** for over 3 seconds to activate the clock setting mode.
↳ **CLOCK SET** scrolls on the display, and then **[24H MODE]** (24-hour time format) appears.
- 2 Press **VOL +/-** to select **[24H MODE]** or **[12H MODE]** (12-hour time format), and then press **CLOCK** to confirm.
↳ The hour digits begin to blink.
- 3 Press **VOL +/-** to set the hour.
- 4 Press **CLOCK** to confirm.
↳ The minute digits begin to blink.
- 5 Press **VOL +/-** to set the minute.
- 6 Press **CLOCK** to confirm.

Adjust brightness of display panel

- 1 In power-on or standby mode, press **DIM** repeatedly to select different brightness levels.

Turn on or off LED light

- 1 In power-on mode, press and hold **DIM** to turn on or off the LED light at the bottom of the unit and at the volume knob.

Store radio stations automatically

If no radio stations are stored, the unit can store radio stations automatically.

- 1 Turn on the unit.
- 2 Press **RADIO**.
↳ **[AUTO INSTALL -- PRESS PLAY -- STOP CANCEL]** (press **▶|||** to start automatic installation, or press **■** to cancel) is displayed.
- 3 Press **▶|||**.
↳ The unit automatically stores radio stations with sufficient signal strength.
↳ After all available radio stations are stored, the first stored radio station is broadcast automatically.

Find the correct viewing channel

- 1 Press **⏻** to turn on the unit.
- 2 Press **DISC** to switch to disc mode.

- 3 Turn on the TV and switch to the correct video-in channel in one of the following ways:
- Go to the lowest channel on your TV, then press the Channel Down button until you see the blue screen.
 - Press the source button repeatedly on the remote control of your TV.

 Tip

- The video-in channel is between the lowest and highest channels and may be called FRONT, A/V IN, VIDEO etc. See the TV user manual on how to select the correct input on the TV.

Select the correct TV system

Change this setting if the video does not appear correctly. By default, this setting matches the most common setting for TVs in your country.

- 1 Press **SYSTEM MENU**.
- 2 Select [**Video Setup**].
- 3 Select [**TV Type**] and then press **▶▶**.
- 4 Select a setting and then press **OK**.
 - **[NTSC]** - For TV with NTSC color system.
 - **[PAL]** - For TV with PAL color system.
 - **[Multi]** - For TV that is compatible with both PAL and NTSC.
- 5 To exit the menu, press **SYSTEM MENU**.

Change system menu language

- 1 Press **SYSTEM MENU**.
- 2 Select [**General Setup**].
- 3 Select [**OSD Language**] and then press **▶▶**.
- 4 Select a setting and then press **OK**.
- 5 To exit the menu, press **SYSTEM MENU**.

5 Play

 Caution

- Risk of damage to the unit! During play, never move the unit.

Play a disc

 Caution

- Never look at the laser beam inside the unit.
- Risk of product damage! Never play discs with accessories such as disc stabilizer rings or disc treatment sheets.
- Never put any objects other than discs into the disc compartment.

- 1 Press **DISC** to select the DISC source.
- 2 Press **▲** on the front panel.
↳ The disc tray opens.
- 3 Place a disc onto the tray and press **▲**.
↳ Ensure that the label faces up.
- 4 Play starts automatically.
 - To stop play, press **■**.
 - To pause or resume play, press **▶||**.
 - To skip to the previous/next title/ chapter/track, press **◀|** / **|▶**.

If play does not start automatically:

- 1 Select a title/chapter/track and then press **▶||**.

 Tip

- To play a locked DVD, enter the 6-digit parental control password.

Use the disc menu

When you load a DVD/(S)VCD disc, a menu may be displayed on the TV screen.

To access or exit the menu manually:

1 Press **DISC MENU**.

For VCD with PlayBack Control (PBC) feature (version 2.0 only):

The PBC feature allows you to play VCD interactively according to the menu screen.

- 1** During play, press **DISC MENU** to enable/disable playback control.
 - ↳ When PBC is enabled, the menu screen is displayed.
 - ↳ When PBC is disabled, normal play is resumed.

Select an audio language

You can select an audio language for a DVD or DivX (Ultra) video.

- 1** During disc play, press **AUDIO**.
 - ↳ The language options appear. If the selected audio channels is unavailable, the default disc audio channel is used.



Note

- For some DVDs, the language can only be changed from the disc menu. Press **DISC MENU** to access the menu.

Select a subtitle language

You can select a subtitle language for a DVD or DivX (Ultra) video.

- 1** During play, press **SUBTITLE** repeatedly.



Note

- For some DVDs, the language can only be changed from the disc menu. Press **DISC MENU** to access the menu.

Play from USB or recorded discs

You can play DivX (Ultra)/MP3/WMA/JPEG picture files copied onto a CD-R/RW, recordable DVD or USB storage device.

- 1** Select a source.
 - For a USB storage device, press **USB**.
 - For a disc, press **DISC**.
- 2** Insert the USB storage device or disc.
 - ↳ The play starts automatically.

To select a specified file for play,

- 1** Press **■** to stop play.
- 2** Press **▲** / **▼** to select a folder, and then press **OK** to confirm.
 - To return to the upper-level directory, press **▲** / **▼** to select **⏪**, and then press **OK**.
- 3** Press **▲** / **▼** to select a file from the folder.
- 4** Press **▶||** to start play.
 - To pause or resume play, press **▶||**.
 - To skip to the previous/next file, press **◀|▶**.
 - To change the subtitle language during the play of a DivX (Ultra) video, press **SUBTITLE**.

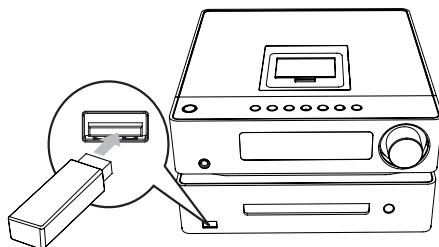



Note

- You can only play DivX (Ultra) videos rented or purchased through the DivX registration code of this unit.
- Subtitle files with the following filename extensions (.srt, .smi, .sub, .ssa, .ass) are supported but do not appear on the file navigation menu.
- The subtitle filename has to be the same as the file name of the video.

Play a slideshow with background music

This apparatus can play MP3/WMA files and JPEG photos simultaneously.



Note

- The MP3/WMA and JPEG files must be stored on the same disc or USB storage device.

- 1 Play an MP3/WMA file.
- 2 Navigate to the photo folder/album and press **▶||** to start the slideshow.
 - ↳ Slideshow begins and continues till the end of the photo folder or album.
 - ↳ Audio continues till the end of the last file.
 - To return to the menu, press **↩** **BACK**.
 - To stop the slideshow, press **■**.

Play control

Select repeat/shuffle play options

- 1 During play, press **MODE** repeatedly to select a play option.
 - To resume normal play, press **MODE** repeatedly until no option is displayed.

Search forward/backward

- 1 During video/audio play, press **◀◀/▶▶** repeatedly to select a search speed.
 - To resume play at normal speed, press **▶||**.

Resume video play from last stopped point



Note

- This feature is only available for DVD/VCD play.

- 1 In stop mode and when the disc has not been removed, press **▶||**.

To cancel resume mode and stop play completely:

- 1 In stop mode, press **■**.

Play options

Display play information

- 1 During play, press **INFO/RDS** to display play information on the TV.

Zoom in/out image

- 1 During video play, hold **▼ (ZOOM)** to zoom in/out the image.
 - When the image is zoomed in, you can press **◀/▶** to pan through the image.

Slow forward play

- 1 During video play, press **▼** to select a slow forward speed.
 - ↳ The sound is muted.
 - To resume play at normal speed, press **▶||**.

Slow backward play

- 1 During video play, press **▲ (SLOW)** to select a slow backward speed.
 - ↳ The sound is muted.
 - To resume play at normal speed, press **▶||**.

Change the audio channel

 Note

- This feature is only available for VCDs and DivX (Ultra) videos.

- 1 During play, press **AUDIO** repeatedly to select an audio channel available on the disc:
 - Mono Left
 - Mono Right
 - Stereo

Picture view options

Select a slide show play mode

You can view pictures as slide show in different play modes.

- 1 Press **MODE** repeatedly.

Rotate picture

- 1 During play, press **◀/▶** to rotate the picture anti-clockwise/clockwise.

6 Play iPod/iPhone/iPad

You can enjoy audio from iPod/iPhone/iPad through this unit.

 Note

- The audio is only output through the supplied speakers.

Compatible iPod/iPhone/iPad

The unit supports the following iPod, iPhone and iPad models.

List of compatible iPod/iPhone/iPad

Made for

- iPad
- iPhone 4
- iPhone 3GS
- iPhone 3G
- iPhone
- iPod classic
- iPod 5G
- iPod 4G
- iPod nano (1st, 2nd, 3rd, 4th, 5th, and 6th generation)
- iPod touch (1st, 2nd, 3rd, and 4th generation)
- iPod mini

 Note

- iPod with color display, iPod classic, and iPod with video are not compatible with dock charging.

Load the iPod/iPhone/iPad

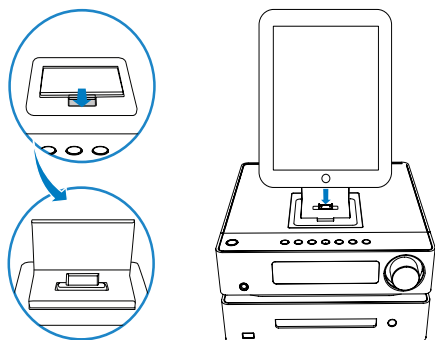

- 1 Lift up the iPod/iPhone/iPad dock on the top panel until you hear a click.
- 2 Place the iPod/iPhone/iPad in the dock.

Play audio from the iPod/iPhone/iPad

- 1 Make sure that your iPod/iPhone/iPad has been loaded securely.
- 2 Press **DOCK** to select the iPod/iPhone/iPad source.
- 3 Play audio on your iPod/iPhone/iPad.
 - To pause/resume play, press **▶||**.
 - To skip to a track, press **◀|▶**.
 - To navigate the menu: press **↩** **BACK** to access the menu, press **▲/▼** to select an item, and then press **OK** to confirm.

Charge the iPod/iPhone/iPad

When the unit is connected to power, the docked iPod/iPhone/iPad begins to charge.

Remove the iPod/iPhone/iPad

- 1 Pull the iPod/iPhone/iPad out of the dock.
- 2 Press down to hide the dock.

7 Listen to radio

The unit can automatically search and store radio stations (see "Get started" > "Store radio stations automatically"). You can also search and store radio stations manually.

Tune to a radio station

- 1 Press **RADIO**.
- 2 Press and hold **◀◀/▶▶** for more than 2 seconds.
 - ↳ The radio tunes to a station with strong reception automatically.
- 3 Repeat step 2 to tune to more stations.
 - To tune to a weak station, press **◀◀/▶▶** repeatedly until you find optimal reception.

Tip

- **[STEREO]** is the default setting for tuner mode.
- In tuner mode, you can press **OK** repeatedly to switch between **[STEREO]** and **[MONO]**. The unit memorizes your setting even if you turn off the unit or turn to other sources.

Program radio stations automatically

Note

- You can program a maximum of 20 preset radio stations.

- 1 Press and hold **PROGRAM** for 2 seconds to activate automatic programming.
 - ↳ **[AUTO]** (auto) is displayed briefly.
 - ↳ All available stations are programmed in the order of waveband reception strength.
 - ↳ The first programmed radio station is broadcast automatically.

Program radio stations manually

Note

- You can program a maximum of 20 preset radio stations.

- 1 Tune to a radio station.
- 2 Press **PROGRAM** to activate programming.
- 3 Press **◀/▶** to allocate a number from 1 to 20 to this radio station, then press **PROGRAM** to confirm.
 - ↳ The preset number and the frequency of the preset station are displayed.
- 4 Repeat the previous steps to program other stations.

Note

- To overwrite a programmed station, store another station in its place.

Tune to a preset radio station

- 1 Press **◀/▶** to select a preset number that you want.

8 Adjust sound

Adjust volume level

- 1 During play, press **VOL +/-** to increase/decrease the volume level.

Select a sound effect

Note

- You cannot use different sound effects at the same time.

Adjust bass level

- 1 During play, press **BASS** to enter bass adjustment.
- 2 Press **VOL +/-** to adjust the bass level.

Adjust treble level

- 1 During play, press **TREBLE** to enter treble adjustment.
- 2 Press **VOL +/-** to adjust the treble level.

Select automatic loudness control

The loudness feature enables the system to increase the treble and bass sound effect at low volume automatically (the higher the volume, the lower the treble and bass increase).

- 1 During play, press **LOUDNESS** to turn on/off automatic loudness control.

Mute sound

- 1 During play, press **⏸** to mute/resume sound.

9 Adjust settings

- 1 Press **SYSTEM MENU**.
- 2 Select a setup page.
- 3 Select an option and then press **▶▶**.
- 4 Select a setting and then press **OK**.
 - To return to the previous menu, press **◀◀**.
 - To exit the menu, press **SYSTEM MENU**.

General setup

On the **[General Setup]** page, you can set the following options:

[Disc Lock]

Set play restriction for specific discs.

Before you start, place the disc in the disc compartment (maximum 40 discs can be locked).

- **[Lock]** – Restrict access to the current disc. You need to enter a password to unlock and play the disc.
- **[Unlock]** – Play all discs.

Tip

- To set or change the password, go to **[Preference Setup] > [Password]**.

[Display Dim]

Change the brightness level of the display panel on this unit.

- **[100%]** – Normal brightness.
- **[70%]** – Medium brightness.
- **[40%]** – Dimmest display.

[OSD Language]

Select the preferred language for on-screen display.

[Screen Saver]

The screen saver protects the TV screen damage due to prolonged exposure to a static image.

- **[On]** – Enable the screen saver.
- **[Off]** – Disable the screen saver.

[Sleep Timer]

Switches to standby automatically after the preset time.

- **[15 mins]**, **[30 mins]**, **[45 mins]**, **[60 mins]**, **[90 mins]**, **[120 mins]** – select the count down time before the apparatus switches to standby.
- **[Off]** – disable sleep mode.

[DivX(R) VOD Code]

Display the DivX® registration code.

Tip

- Enter this DivX registration code when you rent or purchase video from www.divx.com/vod. The DivX videos rented or purchased through the DivX® VOD (Video On Demand) service can be played only on the device to which it is registered.

Audio setup

On the **[Audio Setup]** page, you can set the following options:

[HDMI Audio]

When you connect this apparatus and TV with an HDMI cable, select the audio output setting for this connection.

- **[On]** – the sound is output through both your TV and this apparatus. If the audio format on the disc is not supported, it is downmixed to two-channel sound (Linear-PCM).
- **[Off]** – disable audio output from the TV. The sound is only output through this apparatus.

[Audio Sync]

When you play a video disc, set the default delay time for audio output.

- 1) To start, press **OK**.
- 2) Select a speaker delay in the menu, then press **◀◀ / ▶▶** to set the delay time.
- 3) Press **OK** to confirm and exit.

[Night Mode]

Make loud sound level softer and soft sound level louder so that you can watch the DVD movies at a low volume, without disturbing others.

- **[On]** – enjoy quiet viewing at night (DVDs only).
- **[Off]** – enjoy surround sound with its full dynamic range.

Video setup

On the **[Video Setup]** page, you can set the following options:

[TV Type]

Change this setting if the video does not appear correctly. By default, this setting matches the most common setting for TVs in your country.

- **[PAL]** - For PAL-system TV.
- **[Multi]** - For TV that is compatible with both PAL and NTSC.
- **[NTSC]** - For NTSC-system TV.

[TV Display]

The TV format determines the aspect ratio of display according to the type of TV you have connected.



4:3 Pan Scan (PS)

4:3 Letter Box (LB)

16:9 (Wide Screen)

- **[4:3 Pan Scan]** – For 4:3 screen TV: full-height display with the trimmed sides.
- **[4:3 Letter Box]** – For 4:3 screen TV: wide-screen display with black bars on the top and bottom of the screen.
- **[16:9 Wide Screen]** – For wide-screen TV: display ratio 16:9.

[Picture Settings]

Select a predefined set of picture color settings.

- **[Standard]** – Original color setting.
- **[Vivid]** – Vibrant color setting.
- **[Cool]** - Soft color setting.
- **[Personal]** – Customizes the color setting. Set the level of brightness, contrast, sharpness/tint and color saturation, then press **OK**.

[HDMI Setup]

When you connect this apparatus and TV with an HDMI cable, select the best HDMI video setting that your TV supports.

- **[HDMI Video]** – Select a resolution for high definition videos.
- **[Wide Screen Format]** – Select a display format for wide screen videos.
- **[HDMI Deep Color]** – Create vivid images with more color details when the video content is recorded in Deep Color and the TV supports this feature.
- **[EasyLink Setup]** – This unit supports Philips EasyLink which uses the HDMI CEC (Consumer Electronics Control) protocol. You can use a single remote control to control EasyLink compliant devices that are connected through HDMI.
 - **[EasyLink]** - Enable or disable the EasyLink feature.
 - **[One Touch Play]** - After you enable this feature, the connected HDMI CEC TV automatically switches to the HDMI input channel when you play a disc.
 - **[One Touch Standby]** - After you enable this feature, you can press and hold **⏻** on the remote control of this unit to switch all connected HDMI CEC devices to standby mode simultaneously.
 - **[System Audio Control]** – When you play audio that is routed from the connected devices, this unit

switches to the corresponding audio source automatically. After you enable this feature, proceed to **[Audio Input Mapping]** to scan and map all the connected devices.

- **[Audio Input Mapping]** - When you map the audio input correctly, this unit switches to the audio from the played device automatically.



Note

- You must turn on the HDMI CEC operations on the TV/devices before you can enjoy the EasyLink controls. See the TV/devices manual for details.
- Philips does not guarantee 100% interoperability with all HDMI CEC compliant devices.

Preferences

On the **[Preferences]** page, you can set the following options:

[Audio]

Select the preferred audio language for disc play.

[Subtitle]

Select the preferred subtitle language for disc play.

[Disc Menu]

Select the preferred disc menu language.



Note

- If the language you have set is not available on the disc, the disc uses its own default language.
- For some discs, the subtitle/audio language can only be changed from the disc menu.

[Parental]

Restricts access to discs that are unsuitable for children. These types of discs must be recorded with ratings.

- 1) Press **OK**.
- 2) Select a rating level, then press **OK**.
- 3) Press the numeric keys to enter the password.



Note

- Rated discs above the level you set in **[Parental]** require a password to be played.
- The ratings are country-dependent. To allow all discs to play, select '8'.
- Some discs have ratings printed on them but are not recorded with ratings. This function has no effect on such discs.

[PBC]

Turns on or off the content menu of VCDs/SVCDs with PBC (playback control) feature.

- **[On]** - display index menu when you load a disc for play.
- **[Off]** - skip the menu and start play from the first title.

[MP3/JPEG Display]

Select to display the folders or display all the files.

- **[View Files]** – display all the files.
- **[View Folders]** – display the folders of MP3/WMA files.

[Password]

Set or change the password for locked discs and play restricted DVDs.

- 1) Press the numeric keys to enter '000000' or your last set password at **[Old Password]** field.
- 2) Enter the new password at **[New Password]** field.
- 3) Enter the new password again at **[Confirm Password]** field.
- 4) Press **OK** to exit the menu.



Note

- If you forget the password, enter '000000' before you set a new password.

[DivX Subtitle]

Select a character set that supports the DivX subtitle.

 Note

- Ensure that the subtitle file has the exact same file name as the movie file. If for example the file name of the movie is 'Movie.avi', then you will need to name the text file 'Movie.sub' or 'Movie.srt'.

[Version Info]

Display the software version of this apparatus.

[Default]

Reset all the settings to factory default, except for the password and parental settings.

10 Other features

Activate demonstration mode

You can see an overview of all features.

- 1 In the standby mode with clock display (if set), press  on the main unit to activate the demonstration mode.
 - ↳ A demonstration of major available features starts.

To deactivate the demonstration mode:

- 1 Press  on the main unit again.

Set alarm timer

This unit can be used as an alarm clock. You can select CD, iPod/iPhone/iPad playlist, FM or USB as alarm source.



 Note

- Ensure that you have set the clock correctly.

- 1 In standby mode, press and hold **SLEEP/TIMER** until **[TIMER SET]** (set timer) scrolls on the display.
- 2 Press a source key to select the corresponding source: CD, iPod/iPhone/iPad playlist, FM, or USB.
 - If iPod/iPhone/iPad playlist is selected as the alarm source, you need create a playlist called "PHILIPS" in your iPod/iPhone/iPad.
 - If no playlist called "PHILIPS" is created in the iPod/iPhone/iPad or no track is stored in the playlist, the unit switches to the iPod/iPhone/iPad alarm source.
- 3 Press **SLEEP/TIMER** to confirm.
 - ↳ The hour digits are displayed and begin to blink.

- 4 Press **VOL +/-** repeatedly to set hour, and then press **SLEEP/TIMER** again.
↳ The minute digits are displayed and begin to blink.
- 5 Press **VOL +/-** to set minute, and then press **SLEEP/TIMER** to confirm.
- 6 Press **VOL +/-** to adjust volume, and then press **SLEEP/TIMER** to confirm.
↳ A clock icon appears on the display.

Activate/deactivate alarm timer

- 1 In the standby mode, press **SLEEP/TIMER** repeatedly.
↳ If timer is activated,  is displayed.
↳ If timer is deactivated,  disappears on the display.



Tip

- The alarm timer is not available when the source is set as 'MP3 LINK/AUX'.
- If the CD/USB/iPod/iPhone/iPad source is selected but no disc is placed or no USB/iPod/iPhone/iPad connected, the unit switches to FM automatically.

Set the sleep timer

This unit can switch to standby mode automatically after a set period.

- 1 When the unit is turned on, press **SLEEP/TIMER** repeatedly to select a preset period (in minutes).
↳ When the sleep timer is activated,  is displayed.

To deactivate the sleep timer

- 1 Press **SLEEP/TIMER** repeatedly until [**SLE OFF**] (sleep off) is displayed.
↳ When the sleep timer is deactivated,  is no longer displayed.

Listen to an audio device

You can listen to an audio device through this unit.

- 1 Make sure that the external audio device is connected to this unit (see 'Connect' > 'Connect an external audio device').
- 2 Press **MP3 LINK/AUX** repeatedly to select the audio input through the **MP3-LINK** socket or **AUX IN (L and R)** sockets.
- 3 Start to play the device (see the device user manual).

Listen through headphone

- 1 Plug a headphone into the  socket.

11 Product information

Note

- Product information is subject to change without prior notice.

Specifications

Amplifier

Rated Output Power	2 X 80 W RMS
Frequency Response	30 Hz - 16000 Hz, ± 3 dB
Signal to Noise Ratio	> 82 dBA
Aux Input	1000mV RMS 22k ohm

Disc

Laser Type	Semiconductor
Disc Diameter	12 cm/8 cm
Video Decoding	MPEG-1 / MPEG-2 / DivX
Video DAC	12 Bits
Signal System	PAL / NTSC
Video Format	4:3 / 16:9
Video S/N	> 57 dB
Audio DAC	24 Bits / 96 kHz
Total Harmonic Distortion	< 0.1% (1 kHz)
Frequency Response	4 Hz - 20 kHz (44.1 kHz) 4 Hz - 22 kHz (48 kHz) 4 Hz - 24 kHz (96 kHz)
S/N Ratio	> 82 dBA

Tuner (FM)

Tuning Range	87.5 - 108MHz
Tuning grid	50KHz
Sensitivity - Mono, 26dB S/N Ratio	<22 dBf
Sensitivity - Stereo, 46dB S/N Ratio	<43 dBf
Search Selectivity	<28dBf
Total Harmonic Distortion	<2%
Signal to Noise Ratio	>50dB

Speakers

Speaker Impedance	6 ohm
Speaker Driver	13cm woofer + 2.5cm Dome tweeter
Sensitivity	> 86 dB/m/W \pm 4dB/m/W

General information

AC power	220 V ~, 50 Hz
Operation Power Consumption	45 W
Eco Standby Power Consumption	< 0.5 W
Composite Video Output	1.0 V _{p-p} , 75 ohm
Coaxial Output	0.5 V _{pp} \pm 0.1 V _{pp} , 75 ohm
Headphone output	2 X 15 mW, 32 ohm
USB Direct	Version 2.0
Dimensions	
- Main Unit (W x H x D)	270 X 146 X 295 mm
- Speaker Box (W x H x D)	180 X 325 X 282 mm
Weight	
- With Packing	16.5 kg
- Main Unit	4.8 kg
- Speaker Box	2 x 4.6 kg

Supported disc formats

- Digital Video Discs (DVDs)
- Video CDs (VCDs)
- Super Video CDs (SVCDs)
- Digital Video Discs + Rewritable (DVD+RW)
- Compact Discs (CDs)
- Picture (Kodak, JPEG) files on CDR(W)
- DivX(R) disc on CD-R(W):
- DivX 3.11, 4.x and 5.x
- WMA

Supported MP3-CD formats:

- ISO 9660
- Max. title/album name: 12 characters
- Max. title number plus album: 255.
- Max. nested directory: 8 levels.
- Max. album number: 32.
- Max. MP3 track number: 999.
- Supported sampling frequencies for MP3 disc: 32 kHz, 44.1 kHz, 48 kHz.
- Supported Bit-rates of MP3 disc are: 32, 64, 96, 128, 192, 256 (kbps).
- The following formats are not supported:
 - Files like *.VMA, *.AAC, *.DLF, *.M3U,
 - *.PLS, *.WAV
 - Non-English Album/Title name
 - Discs recorded in Joliet format
 - MP3 Pro and MP3 with ID3 tag

Supported formats:

- USB or memory file format FAT12, FAT16, FAT32 (sector size: 512 bytes)
- MP3 bit rate (data rate): 32-320 Kbps and variable bit rate
- WMA v9 or earlier
- Directory nesting up to a maximum of 8 levels
- Number of albums/ folders: maximum 99
- Number of tracks/titles: maximum 999
- ID3 tag v2.0 or later
- File name in Unicode UTF8 (maximum length: 128 bytes)

Unsupported formats:

- Empty albums: an empty album is an album that does not contain MP3/ WMA files, and is not be shown in the display.
- Unsupported file formats are skipped. For example, Word documents (.doc) or MP3 files with extension .dlf are ignored and not played.
- AAC, WAV, PCM audio files
- DRM protected WMA files (.wav, .m4a, .m4p, .mp4, .aac)
- WMA files in Lossless format

USB playability information

Compatible USB devices:

- USB flash memory (USB 2.0 or USB1.1)
- USB flash players (USB 2.0 or USB1.1)
- memory cards (requires an additional card reader to work with this apparatus)

12 Troubleshooting

Caution

- Never remove the casing of this apparatus.

To keep the warranty valid, never try to repair the system yourself.

If you encounter problems when using this apparatus, check the following points before requesting service. If the problem remains unsolved, go to the Philips web site (www.Philips.com/support). When you contact Philips, ensure that your apparatus is nearby and the model number and serial number are available.

No power

- Ensure that the AC cord of the apparatus is connected properly.
- Ensure that there is power at the AC outlet.
- As a power-saving feature, the system switches off automatically 15 minutes after track play reaches the end and no control is operated.

No disc detected

- Insert a disc.
- Check if the disc is inserted upside down.
- Wait until the moisture condensation at the lens has cleared.
- Replace or clean the disc.
- Use a finalized CD or correct format disc.

No picture

- Check the video connection.
- Turn on the TV to the correct Video-In channel.

Black and white or distorted picture

- The disc does not match the TV color system standard (PAL/NTSC).
- Sometimes a slight picture distortion may appear. This is not a malfunction.
- Clean the disc.

The aspect ratio of the TV screen cannot be changed even though you have set the TV display format.

- The aspect ratio is fixed on the loaded DVD disc.
- The aspect ratio may not be changed for some TV systems.

No sound or poor sound

- Adjust the volume.
- Disconnect the headphones.
- Check that the speakers are connected correctly.
- Check if the stripped speaker wires are clamped.

Remote control does not work

- Before you press any function button, first select the correct source with the remote control instead of the main unit.
- Reduce the distance between the remote control and the unit.
- Insert the battery with its polarities (+/- signs) aligned as indicated.
- Replace the battery.
- Aim the remote control directly at the sensor on the front of the unit.

Disc does not play

- Insert a readable disc with the label side facing you.
- Check the disc type, color system and regional code. Check for any scratches or smudges on the disc.
- Press **SYSTEM MENU** to exit the system setup menu.
- Disable the password for parental control or change the rating level.
- Moisture has condensed inside the system. Remove the disc and leave the system turned on for about an hour. Disconnect and reconnect the AC power plug, and then turn on the system again.
- As a power-saving feature, the system turns off automatically 15 minutes after disc play reaches the end and no control is operated.

DivX video files cannot be played.

- Ensure that the DivX video file is complete.
- Ensure that the file extension is correct.
- Due to Digital Rights issue, the DRM-protected video files cannot be played through an analog video connection (e.g. composite, component and scart). Transfer the video content onto the Disc Media and play these files.

Poor radio reception

- Increase the distance between the apparatus and your TV or VCR.
- Fully extend the FM antenna.
- Connect an outdoor FM antenna instead.

Audio or subtitle languages cannot be set

- The disc is not recorded with sound or subtitles in multiple languages.
- The audio or subtitle language setting is prohibited on the disc.

Cannot display some files in USB device

- The number of folders or files in the USB device has exceeded a certain limit. This phenomenon is not a malfunction.
- The formats of these files are not supported.

USB device not supported

- The USB device is incompatible with the unit. Try another one.

Timer does not work

- Set the clock correctly.
- Switch on the timer.

Clock/timer setting erased

- Power has been interrupted or the power cord has been disconnected.
- Reset the clock/timer.

部件名称 Name of the Parts	有毒有害物质或元素 Hazardous/toxic Substance					
	铅 (Pb, Lead)	汞 (Hg, Mercury)	镉 (Cd, cadmium)	六价铬(Chromium 6+)	多溴联苯 (PBB)	多溴二苯醚 (PBDE)
Housing 外壳	○	○	○	○	○	○
DVD/CD loader DVD/CD 光盒	×	○	○	○	○	○
VFD Panel VFD 面板	×	×	○	○	○	○
Loudspeakers 喇叭单元	○	○	○	○	○	○
PWBs 电路板组件	×	○	○	○	○	○
Accessories (Remote control & cables) 附件 (遥控器, 电 源线, 连接线)	×	○	○	○	○	○
Batteries in Remote Control (ZnC) 遥控器电池	×	○	○	○	○	○

○: 表示该有毒有害物质在该部件所有均质材料中的含量均在SJ/T11363 - 2006 标准规定的限量要求以下。
○: Indicates that this toxic or hazardous substance contained in all of the homogeneous materials for this part is below the limit requirement in SJ/T11363 – 2006.

×: 表示该有毒有害物质至少在该部件的某一均质材料中的含量超出SJ/T11363 – 2006 标准规定的限量要求。

X: Indicates that this toxic or hazardous substance contained in at least one of the homogeneous materials used for this part is above the limit requirement in SJ/T11363 - 2006.



环保使用期限 Environmental Protection Use Period

This logo refers to the period (10 years)

电子信息产品中含有的有毒有害物质或元素在正常使用的条件下不会发生外泄或突变，电子信息产品用户使用该电子信息产品不会对环境造成严重污染或对其人身、财产造成严重损害的期限。

This logo refers to the period (10 years) during which the toxic or hazardous substances or elements contained in electronic information products will not leak or mutate so that the use of these [substances or elements] will not result in any severe environmental pollution, any bodily injury or damage to any assets.

