

DVD VIDEO PLAYER

DVP3005K

User manual

Thank you for choosing Philips.

Need help fast?

Read your User's Manual first for quick tips that make using your Philips product more enjoyable.

If you have read your instructions and still need assistance, you may access our online help at www.philips.com/support



PHILIPS

3139 246 15791

General Information

Environmental Information

All unnecessary packaging has been omitted. The packaging has been made easy to separate into three materials: cardboard (box), polystyrene foam (buffer) and polyethylene (bags, protective foam sheet).

Your DVD player consists of materials which can be recycled and reused if disassembled by a specialised company. Please observe the local regulations regarding the disposal of packaging materials, exhausted batteries and old equipment.

Laser safety

This unit employs a laser. Due to possible eye injury, only a qualified service person should remove the cover or attempt to service this device.

NOTE:
PICTURES SHOWN MAYBE DIFFERENT BETWEEN COUNTRIES.

CAUTION
(WARNING LOCATION: ON THE BACKPLATE OF THE SET)

NEVER MAKE OR CHANGE CONNECTIONS WITH THE POWER SWITCHED ON.

Important Note:

Due to the numerous versions of new CD-Audio copy protection or enhanced CD-Audio protection recently available on certain discs, Philips is unable to guarantee that this DVD Player is fully compatible with such new discs. Should you have difficulty playing any such CD-Audio discs, kindly refer them to your CD-Audio disc retailer.

The apparatus shall not be exposed to dripping or splashing and no objects filled with liquids, such as vases, shall be placed on apparatus.

Specifications are subject to change without notice. Trademarks are the property of Koninklijke Philips Electronics N.V. or their respective owners.

For Customer Use:

Read carefully the information located at the rear of your DVD VIDEO player and enter below the Serial No. Retain this information for future reference.

Model No. DVP 3005K

Serial No. _____

LASER

Type	Semiconductor laser GaAlAs
Wave length	650 nm (DVD) 780 nm (VCD/CD)
Output Power	7 mW (DVD) 10 mW (VCD/CD)
Beam divergence	60 degree



Index

English 6



This product incorporates copyright protection technology that is protected by method claims of certain U.S. patents and other intellectual property rights owned by Macrovision Corporation and other rights owners. Use of this copyright protection technology must be authorized by Macrovision Corporation, and is intended for home and other limited viewing uses only unless otherwise authorized by Macrovision Corporation. Reverse engineering or disassembly is prohibited.

Manufactured under license from Dolby Laboratories. "Dolby", "Pro-Logic" and the double-D symbol are trademarks of Dolby Laboratories.

Due to the inconsistency of disc formats provided by various disc manufacturers, your DVD system may require a playability enhancement or upgrade. As DVD technology advances, these enhancements will become common and will be easy to complete.
Go to www.philips.com/support for software upgrade.

3139 246 15791

Language Code

Abkhazian	6566	Inupiaq	7375	Pushto	8083
Afar	6565	Irish	7165	Russian	8285
Afrikaans	6570	Íslenska	7383	Quechua	8185
Amharic	6577	Italiano	7384	Raeto-Romance	8277
Arabic	6582	Ivrit	7269	Romanian	8279
Armenian	7289	Japanese	7465	Rundi	8278
Assamese	6583	Javanese	7486	Samoan	8377
Avestan	6569	Kalaallisut	7576	Sango	8371
Aymara	6589	Kannada	7578	Sanskrit	8365
Azerhijani	6590	Kashmiri	7583	Sardinian	8367
Bahasa Melayu	7783	Kazakh	7575	Serbian	8382
Bashkir	6665	Kernewek	7587	Shona	8378
Belarusian	6669	Khmer	7577	Shqip	8381
Bengali	6678	Kinyarwanda	8287	Sindhi	8368
Bihari	6672	Kirghiz	7589	Sinhalese	8373
Bislama	6673	Komi	7586	Slovensky	8373
Bokmål, Norwegian	7866	Korean	7579	Slovenian	8376
Bosanski	6683	Kuanyama; Kwanyama	7574	Somali	8379
Brezhoneg	6682	Kurdish	7585	Sotho; Southern	8384
Bulgarian	6671	Lao	7679	South Ndebele	7882
Burmese	7789	Latina	7665	Sundanese	8385
Castellano, Español	6983	Latvian	7686	Suomi	7073
Catalán	6765	Letzeburgesch;	7666	Swahili	8387
Chamorro	6772	Limburgan; Limburger	7673	Swati	8383
Chechen	6769	Lingala	7678	Svenska	8386
Chewa; Chichewa; Nyanja	7889	Lithuanian	7684	Tagalog	8476
中文	9072	Luxembourgish;	7666	Tahitian	8489
Chuang; Zhuang	9065	Macedonian	7775	Tajik	8471
Church Slav; Slavonic	6785	Malagasy	7771	Tamil	8465
Chuvash	6786	Magyar	7285	Tatar	8484
Corsican	6779	Malayalam	7776	Telugu	8469
Česky	6783	Maltese	7784	Thai	8472
Dansk	6865	Manx	7186	Tibetan	6679
Deutsch	6869	Maori	7773	Tigrinya	8473
Dzongkha	6890	Marathi	7782	Tonga (Tonga Islands)	8479
English	6978	Marshallese	7772	Tsonga	8483
Esperanto	6979	Moldavian	7779	Tswana	8478
Estonian	6984	Mongolian	7778	Türkçe	8482
Euskara	6985	Nauru	7865	Türkmen	8475
Ελληνικά	6976	Navaho; Navajo	7886	Twi	8487
Faroese	7079	Ndebele, North	7868	Uighur	8571
Français	7082	Ndebele, South	7882	Ukrainian	8575
Frysk	7089	Ndonga	7871	Urdu	8582
Fijian	7074	Nederlands	7876	Uzbek	8590
Gaelic; Scottish Gaelic	7168	Nepali	7869	Vietnamese	8673
Gallegan	7176	Norsk	7879	Volapuk	8679
Georgian	7565	Northern Sami	8369	Walloon	8765
Gikuyu; Kikuyu	7573	North Ndebele	7868	Welsh	6789
Guarani	7178	Norwegian Nynorsk;	7878	Wolof	8779
Gujarati	7185	Occitan; Provençal	7967	Xhosa	8872
Hausa	7265	Old Bulgarian; Old Slavonic	6785	Yiddish	8973
Herero	7290	Oriya	7982	Yoruba	8979
Hindi	7273	Oromo	7977	Zulu	9085
Hiri Motu	7279	Ossetian; Ossetic	7983		
Hrvatski	6779	Pali	8073		
Ido	7379	Panjabi	8065		
Interlingua (International)	7365	Persian	7065		
Interlingue	7365	Polski	8076		
Inuktitut	7385	Português	8084		

Contents

Language Code 5

Introduction

Supplied accessories	8
Care and safety information	8

Connections

Connecting TV	9-10
Using Composite Video jacks (CVBS)	9
Using Component Video jacks (Pr Pb Y) ...	9
Using an accessory RF modulator	10
Connecting the power cord	10
Optional : Connecting to an Audio System .	
.....	11
Stereo system has Dolby Pro Logic or Right	
/ Left Audio In jack	11
Optional: Connecting Digital AV Receiver ...	
.....	11
Receiver has a PCM, Dolby Digital, or	
MPEG2 decoder	11

Functional Overview

Front and Rear Panels	12
Remote Control	13

Getting Started

Step 1: Inserting batteries into the	
Remote Control	14
Using the Remote Control to operate the	
Player	14
Step 2: Setting up the TV	14-16
Setting up Progressive Scan feature (for	
Progressive Scan TV only)	15
To deactivate Progressive manually	16
Selecting the colour system that	
corresponds to your TV	16
Step 3: Setting language preference	17
Setting the OSD Language	17
Setting the Audio, Subtitle and Disc menu	
language	17

Disc Operations

Playable Discs	18
Region Codes	18
Playing discs	18
Basic playback controls	19
Selecting various repeat/shuffle functions	19
Repeat play mode	19
Repeating a section within a chapter/track .	
.....	19
Operations for video playback	20
Using the Disc Menu	20
Zooming in	20
Resuming playback from the last stopped	
point	20
Slow motion	20
Using the OSD menu	20
Special DVD features	21
Playing a Title	21
Camera Angle	21
Changing the Audio Language	21
Subtitles	21
Special VCD & SVCD Features	21-22
Playback Control (PBC)	21
Preview Function (DVD/VCD)	22
Playing MP3/JPEG/Kodak Picture CD	23
General Operation	23
Selecting a folder and track/file	23
Special picture disc features	24
Preview Function (JPEG)	24
Zoom picture	24
Playback with multi-angles	24
Scan Effect	24

Karaoke Operations

Playing Karaoke discs	25
General Operation	25
Key setting	25
Vocal	25
Mode	25

Contents

English

DVD Setup Menu Options

General Setup menu	26-27
Locking/Unlocking the disc for viewing ...	26
Dimming player's display screen	26
Programming disc tracks	26-27
OSD Language	27
Screen Saver - turning on/off	27
Sleep	27
Audio Setup Menu	28-30
Analog output	28
Digital Audio Setup	28
Sound Mode	29
CD Upsampling	29
Night Mode - turning on/off	30
Video Setup Menu	30-31
TV Type	30
Setting the TV Display	31
Progressive - turning on/off	31
Picture Setting	32
Preference Page	33-35
Audio, Subtitle, Disc Menu	33
Restricting playback by Parental Control	33-34
PBC	34
MP3/JPEG Menu - turning on/off	34
Changing the Password	35
Restoring to original settings	35

Troubleshooting	36-37
------------------------------	-------

Specifications	38
-----------------------------	----

Glossary	39
-----------------------	----

Introduction

Supplied accessories

Audio (white, red)
cables /
Video (yellow) cable

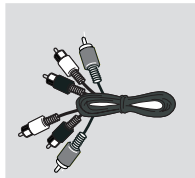

Remote Control
and
two AA batteries

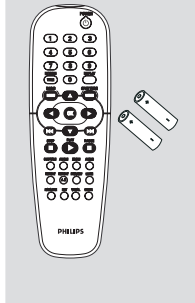

Care and safety information

- **Power consumption**
 - When the system is switched to Standby mode, it is still consuming power. To disconnect the system from the power supply completely, remove the AC power plug from the wall jack.
- **Avoid high temperatures, moisture, water and dust**
 - Do not expose the player, batteries or discs to humidity, rain, sand or excessive heat (caused by heating equipment or direct sunlight.)
- **Avoid condensation problem**
 - The lens may cloud over when the player is suddenly moved from cold to warm surroundings, making it impossible to play a disc. Leave the player in the warm environment until the moisture evaporates.

- **Do not block the vents**

- Do not operate the DVD Player in an enclosed cabinet, allow about 10 cm (4 inch) of free space all around the player for adequate ventilation.

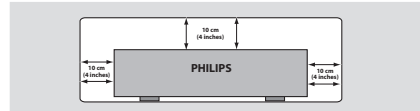

- **Care of the cabinet**

- Use a soft cloth slightly moistened with a mild detergent solution. Do not use a solution containing alcohol, spirits, ammonia or abrasives.

- **Finding a suitable location**

- Place the player on a flat, hard, and stable surface.

- **Disc handling**

- To clean a CD, wipe it in a straight line from the center towards the edge using a soft, lint-free cloth. A cleaning agent may damage the disc!
- Write only on the printed side of a CDR(W) and only with a soft felt-tipped pen.
- Handle the disc by its edge, do not touch the surface.

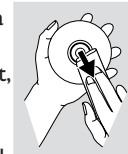

Connections

English

Connecting TV

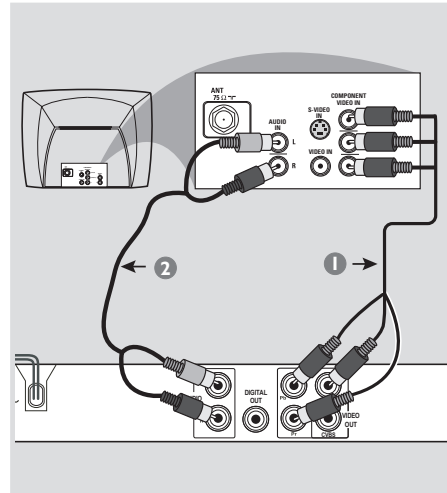
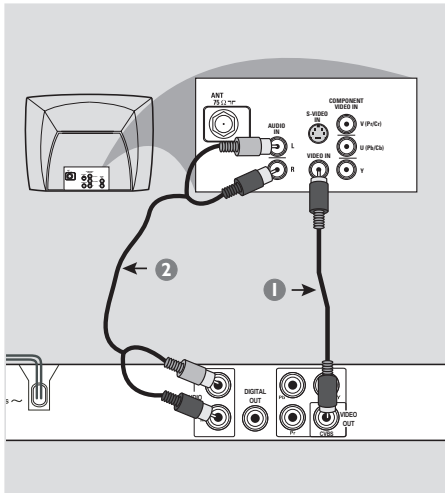

IMPORTANT!

- You only need to make one video connection from the following options, depending on the capabilities of your TV system.
- Connect the DVD system directly to the TV.

Using Composite Video jacks (CVBS)

- 1 Use the composite video cable (yellow) to connect the DVD Player's CVBS (VIDEO) jack to the video input jack (or labeled as A/V In, Video In, Composite or Baseband) on the TV (*cable supplied*).
- 2 To hear the sound of this DVD Player through your TV, use the audio cables (white/red) to connect AUDIO OUT (L/R) jacks of the DVD Player to the corresponding AUDIO IN jacks on the TV (*cable supplied*).

IMPORTANT!

- The progressive scan video quality is only possible when using Y Pb Pr and a progressive scan TV is required.

Using Component Video jacks (Y Pb Pr)

- 1 Use the component video cables (red/blue/green) to connect the DVD system's Y Pb Pr jacks to the corresponding Component video input jacks (or labeled as Y Pb Pr) on the TV (*cable not supplied*).
- 2 To hear the sound of this DVD Player through your TV, use the audio cables (white/red) to connect AUDIO OUT (L/R) jacks of the DVD Player to the corresponding AUDIO IN jacks on the TV (*cable supplied*).
- 3 Proceed to page 15 for detailed Progressive Scan set up.

Connections

Connecting the power cord

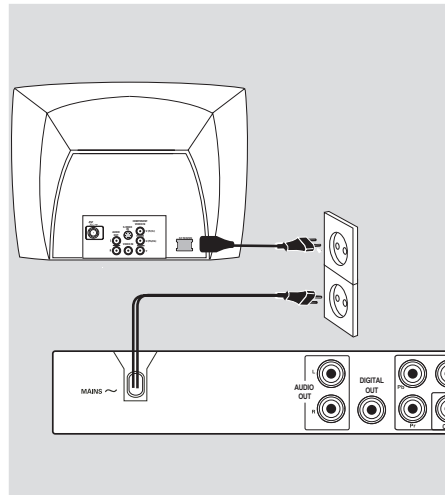
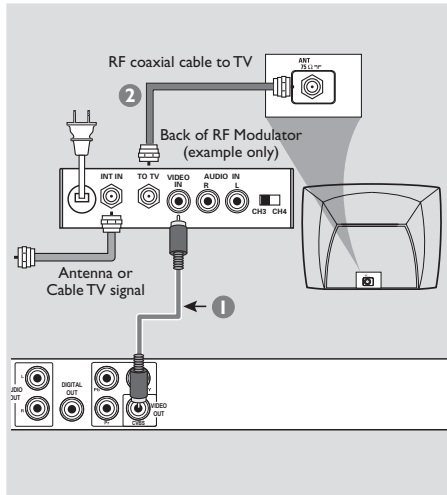

IMPORTANT!

– If your TV only has a single Antenna In jack (or labeled as 75 ohm or RF In,) you will need an RF modulator in order to view the DVD playback on the TV. See your electronics retailer or contact Philips for details on RF modulator availability and operations.

Using an accessory RF modulator

- 1 Use the composite video cable (yellow) to connect the DVD Player's CVBS (VIDEO OUT) jack to the video input jack on the RF modulator.
- 2 Use the RF coaxial cable (not supplied) to connect the RF modulator to your TV's RF jack.

After everything is connected properly, plug in the AC power cord to the power outlet.

Never make or change any connections with the power switched on.

When no disc is loaded, press **STANDBY ON** on the DVD Player front panel, "NO DISC" may appear on the display panel.

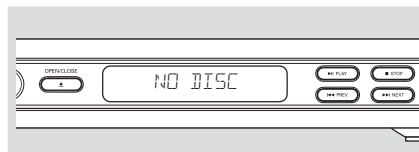

Connections

English

Optional: Connecting to an Audio System

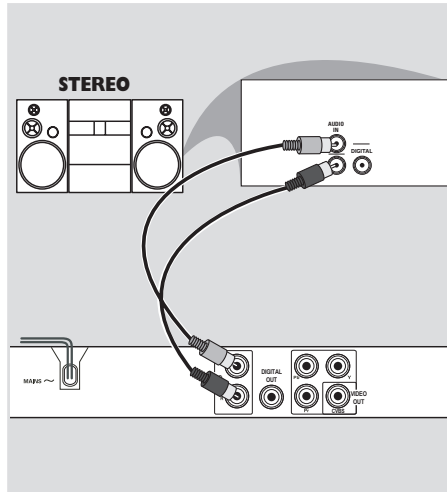

Stereo system has Dolby Pro Logic or Right / Left Audio In jack

- 1 Select one of the video connections (CVBS VIDEO IN, SCART or COMPONENT VIDEO IN) depending on the options available on your TV.
- 2 Use the audio cables (white/red) to connect **AUDIO OUT (L/R)** jacks of the DVD Player to the corresponding AUDIO IN jacks on the stereo system (cable supplied).

Optional: Connecting Digital AV Receiver

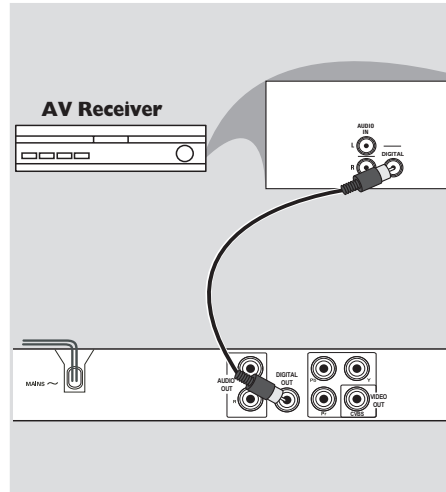

Receiver has a PCM, Dolby Digital, or MPEG2 decoder

- 1 Select one of the video connections (CVBS VIDEO IN, SCART or COMPONENT VIDEO IN) depending on the options available on your TV.
- 2 Connect the COAXIAL jack of the DVD Player to the corresponding Digital Audio In jack on your Receiver (cable not supplied).
- 3 Set the DVD Player's Digital Output to PCM-ONLY or ALL depending on the capabilities of your Receiver (see page 28 "Digital Output").

Helpful Hint:

- If the audio format of the Digital Output does not match the capabilities of your receiver, the receiver will produce a strong, distorted sound or no sound at all.

Functional Overview

Front and Rear Panels

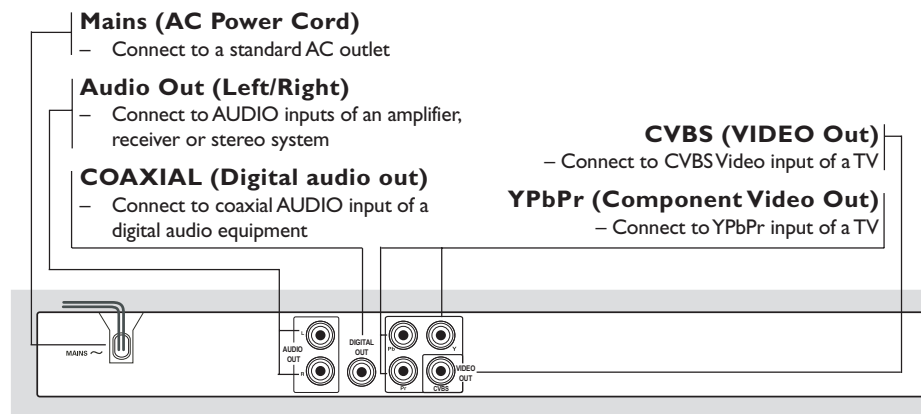
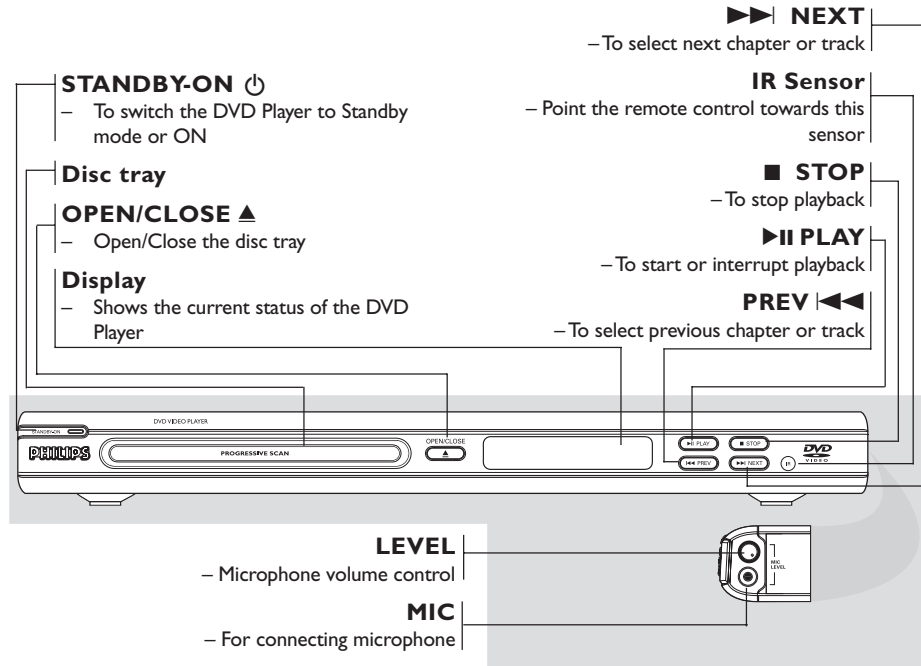

Caution: Do not touch the inner pins of the jacks on the rear panel. Electrostatic discharge may cause permanent damage to the unit.

Functional Overview

English

Remote Control

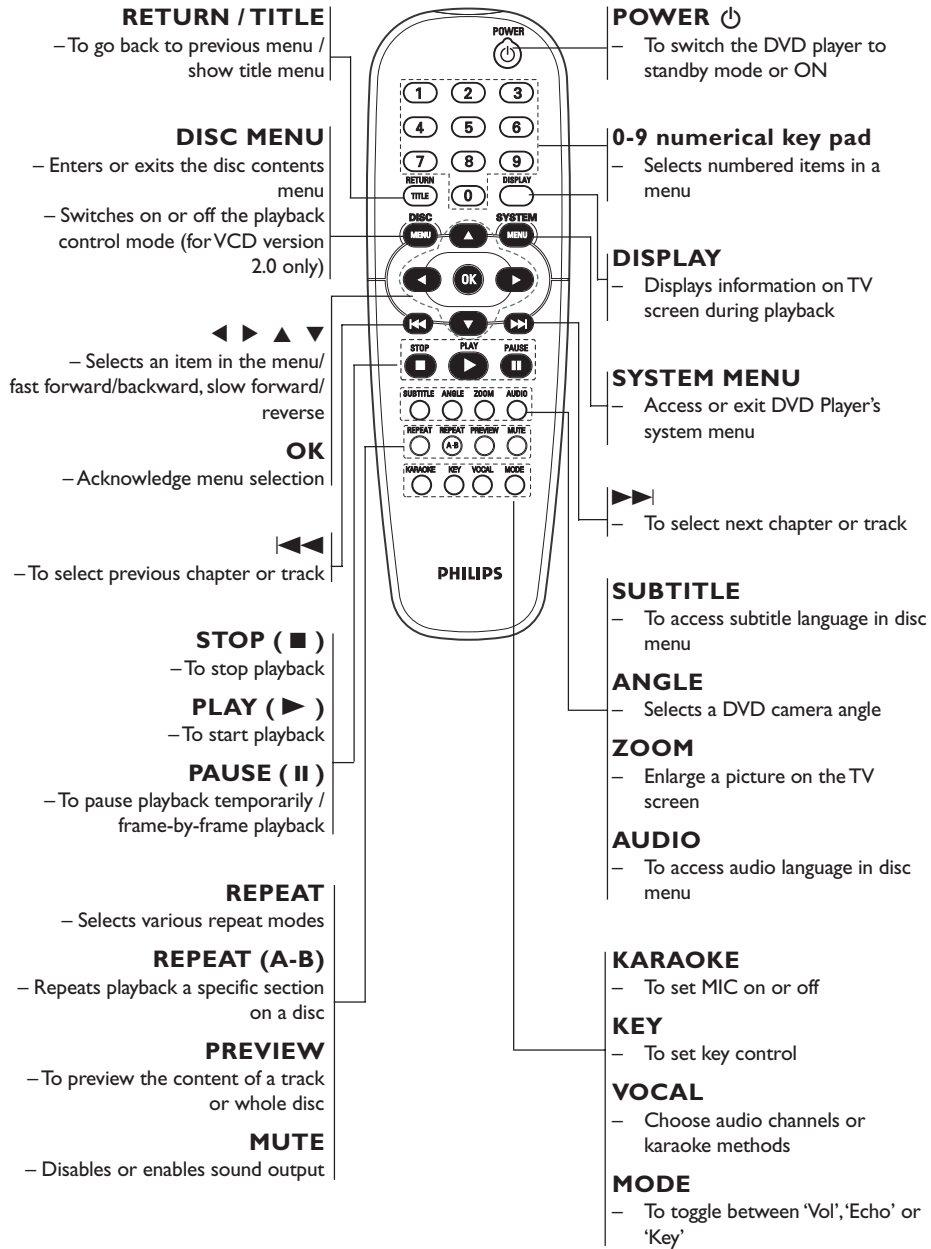

Getting Started

Step 1: Inserting batteries into the Remote Control

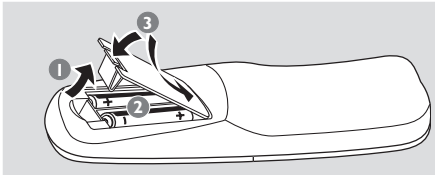

- 1 Open the battery compartment.
- 2 Insert two batteries type R06 or AA, following the indications (+ -) inside the compartment.
- 3 Close the cover.

Using the Remote Control to operate the Player

- 1 Aim the Remote Control directly at the remote sensor (IR) on the front panel.
- 2 Do not put any objects between the Remote Control and the DVD Player while operating the DVD Player.

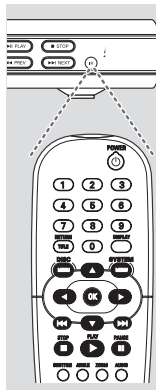

CAUTION!

- Remove batteries if they are exhausted or if the Remote Control is not being used for a long time.
- Do not use old and new or different types of batteries in combination.
- Batteries contain chemical substances, so they should be disposed properly.

Step 2: Setting up the TV

IMPORTANT!

Make sure you have completed all the necessary connections. (See pages 9-10 "Connecting TV").

- 1 Turn on the TV and set to the correct video-in channel. You should see the DVD background screen on the TV.
- 2 Usually these channels are between the lowest and highest channels and may be called FRONT, A/V IN, or VIDEO. See your TV manual for more details.
→ Or, you may go to channel 1 on your TV, then press the Channel down button repeatedly until you see the Video In channel.
→ Or, the TV Remote Control may have a button or switch that chooses different video modes.
→ Or, set the TV to channel 3 or 4 if you are using an RF modulator.
- 3 If you are using external equipment, (eg. audio system or receiver), turn it on and select the appropriate input source for the DVD Player output. Refer to the equipment owner's manual for detail.

Getting Started

Setting up Progressive Scan feature (for Progressive Scan TV only)

The progressive scan display twice the number of frames per seconds than interlaced scanning (ordinary normal TV system). With nearly double the number of lines, progressive scan offers higher picture resolution and quality.

IMPORTANT!

Before enabling the progressive scan feature, you must ensure:

- 1) Your TV can accept progressive signals, a progressive scan TV is required.
- 2) You have connected the DVD player to your TV using Y Pb Pr (see page 9.)

- 1 Turn on your TV.
- 2 Turn off your TV progressive scan mode or turn on interlaced mode (refer to your TV user manual.)
- 3 Press **POWER** on the remote control to turn on the DVD player.
- 4 Select the correct Video Input channel.
(See page 14).
→ The DVD background screen appears on the TV.
- 5 Press **SYSTEM MENU**.
- 6 Press **▶** to select {VIDEO SETUP PAGE}.

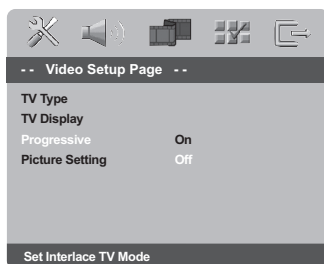

- 7 Select {PROGRESSIVE} to {ON}, then **OK** to confirm.

→ The instruction menu appears on the TV.

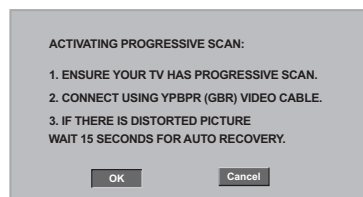

- 8 Press **◀** to highlight **OK** in the menu and press **OK** to confirm.

There will be a distorted picture on your TV at this state until you turn on the progressive scan mode on your TV.

- 9 Turn on your TV progressive scan mode (refer to your TV user manual.)
→ The below menu appears on the TV.

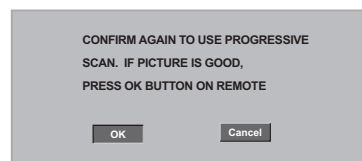

- 10 Press **◀** to highlight **OK** in the menu and press **OK** to confirm.

→ The set up is complete now and you can start enjoy the high quality picture.

TIPS: To return to the previous menu, press **◀**.
To remove the menu, press **SYSTEM MENU**.

Getting Started

To deactivate Progressive manually

- **When the distorted picture still appears on the TV**, it may be due to the connected TV does not accept progressive signals, and progressive is set by mistake. You must reset the unit to interlace format.
- ① **Turn off** your TV progressive scan mode or turn on to interlaced mode (refer to your TV user manual.)
- ② Press **OPEN/CLOSE** on the DVD player to open the disc tray.
- ③ Press **numeric keypad '1'** on the remote control for few seconds.
→ The DVD blue background screen will appear on the TV.

Selecting the colour system that corresponds to your TV

This DVD Player is compatible with both NTSC and PAL. In order for a DVD disc to play on this Player, the colour system of the Disc, the TV and the DVD Player should match.

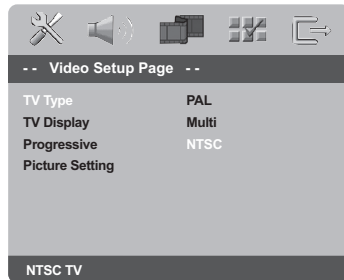

- ① Press **SYSTEM MENU**.
- ② Press **▶** to select {VIDEO SETUP PAGE}.
- ③ Press **▲▼** to highlight {TV TYPE}, then press **▶**.

- ④ Press **▲▼** to highlight one of the options below:

PAL – Select this if the connected TV is PAL system. It will change the video signal of a NTSC disc and output in PAL format.

NTSC – Select this if the connected TV is NTSC system. It will change the video signal of a PAL disc (VCD only) and output in NTSC format.

Multi – Select this if the connected TV is compatible with both NTSC and PAL (multi-system). The output format will be in accordance with the video signal of the disc.

- ⑤ Select an item and press **OK**.

Helpful Hints:

- *Before changing the current TV Standard setting, ensure that your TV supports the 'selected TV Type' system.*
- *If there is no proper picture on your TV, wait for 15 seconds for auto recovery.*

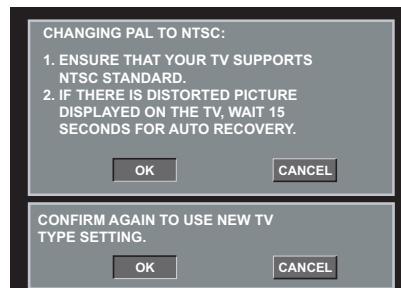

TIPS: To return to the previous menu, press **◀**.
To remove the menu, press **SYSTEM MENU**.

Getting Started

English

Step 3: Setting language preference

You can select your preferred language settings. This DVD Player will automatically switch to the language for you whenever you load a disc.

Setting the OSD Language

The On-screen language for the system menu will remain as you set it, regardless of various disc languages.



- 1 Press **SYSTEM MENU**.
- 2 Press **▶** to select {GENERAL SETUP PAGE}.
- 3 Press **▲ ▼** to highlight {OSD LANGUAGE}, then press **▶**.
- 4 Press **▲ ▼** to select a language and press **OK**.

Setting the Audio, Subtitle and Disc menu language

You can choose your own preferred language or soundtrack from audio, subtitles and disc menu languages. If the language selected is not available on the disc, the disc's default language will be used instead.

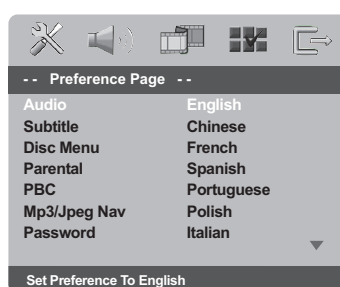

- 1 Press **STOP** twice then, press **SYSTEM MENU**.
- 2 Press **▶** repeatedly to select {PREFERENCE PAGE}.
- 3 Press **▲ ▼** to highlight one of the options below at a time, then press **▶**.
 - 'Audio' (disc's soundtrack)
 - 'Subtitle' (disc's subtitles)
 - 'Disc Menu' (disc's menu)
- 4 Press **▲ ▼** to select a language and press **OK**.

If the language you want is not in the list, then select {OTHERS}, then use the **numeric keypad (0-9)** on the remote to enter the 4-digit language code 'XXXX' (see page 5 "Language Code") and press **OK**.

- 5 Repeat steps 3~4 for other language settings.

TIPS: To return to the previous menu, press **◀**.
To remove the menu, press **SYSTEM MENU**.

Disc Operations

IMPORTANT!

- If the inhibit icon (⊘) appears on the TV screen when a button is pressed, it means the function is not available on the current disc or at the current time.
- Depending on the DVD or VIDEO CD, some operations may be different or restricted.
- Do not push on the disc tray or put any objects other than disc on the disc tray. Doing so may cause the disc player malfunction.

Playable Discs

Your DVD Player will play:

- Digital Video Discs (DVDs)
- Video CDs (VCDs)
- Super Video CDs (SVCDs)
- Digital Video Discs + Recordable[Rewritable] (DVD+R[W])
- Compact Discs (CDs)
- MP3 discs, picture (Kodak, JPEG) files on CD-R(W).
 - JPEG/ISO 9660 format
 - Maximum 30 characters display.
 - Supported sampling frequencies : 32 kHz, 44.1 kHz, 48 kHz (MPEG-1) 16 kHz, 22.05 kHz, 24 kHz (MPEG-2)
 - Supported Bit-rates : 32~256 kbps (MPEG-1), 8~160 kbps (MPEG-2) variable bitrates



Region Codes

DVD discs must be labeled for ALL regions or Region 3 in order to play on this Player. You cannot play Discs that are labeled for other regions.



Helpful Hints:

- It may not be possible to play CD-R/RW or DVD-R/RW in all cases due to the type of disc or condition of the recording.
- If you are having trouble playing a certain disc, remove the disc and try a different one. Improper formatted disc will not play on this DVD Player.

Playing discs

- 1 Connect the power cords of the DVD Player and TV (and any optional stereo or AV receiver) to a power outlet.
- 2 Turn on the TV power and set to the correct Video In channel. (See page 14 "Setting up the TV").
- 3 Press **STANDBY-ON** on the DVD Player front panel.
 - You should see the Philips DVD background screen on the TV.
- 4 Press **OPEN/CLOSE** ▲ button to open the disc tray and load in a disc, then press the same button again to close the disc tray.
 - Make sure the label side is facing up. For double-sided discs, load the side you want to play facing up.
- 5 Playback will start automatically. If not press **PLAY** ►.
 - If a disc menu appears on the TV, see page 20 "Using the Disc Menu".
 - If the disc is locked by parental control, you must enter your six-digit password. (See page 35).

TIPS: The operating features described here might not be possible for certain discs. Always refer to the instructions supplied with the discs.

Disc Operations

Basic playback controls

Unless otherwise stated, all operations described are based on Remote Control use.

Pausing playback

- 1 During playback, press **PAUSE II**.
→ Playback will pause and sound will be muted.
- 2 To resume normal playback, press **PLAY ►**.

Selecting track/chapter

- Press |◀◀ / ▶▶| or use the numeric keypad (0-9) to key in a track/chapter number.
→ Pressing |◀◀| will replay the same track/chapter.

Searching backward/forward

- Press ◀ / ▶, then press **PLAY ►** to resume normal playback.
→ While searching, pressing ◀ / ▶ repeatedly again will decrease/increase the search speed.

Stopping playback

- Press ■.

Selecting various repeat/shuffle functions

Repeat play mode

- While playing a disc, press **REPEAT** continuously to choose a 'Play Mode'.

CHAPTER (DVD)

- to repeat playback of the current chapter.

TRACK/TITLE (CD/SVCD/VCD/DVD)

- to repeat playback of the current track (CD/SVCD/VCD)/title (DVD).

ALL

- to repeat playback of all the disc and all the programmed tracks.

SHUFFLE

- to playback at random order.

OFF

- to cancel the repeat mode.

Helpful Hint:

- For VCD, repeat playback is not possible if the PBC mode is switched on.

Repeating a section within a chapter/track

- 1 While playing a disc, press **REPEAT A-B** at your chosen starting point.
- 2 Press **REPEAT A-B** again at your chosen end point.
→ The section A and B can be set only within the same chapter/track.
→ The section will now repeat continuously.
- 3 To exit the sequence, press **REPEAT A-B**.

TIPS: The operating features described here might not be possible for certain discs. Always refer to the instructions supplied with the discs.

Disc Operations

Operations for video playback (DVD/VCD/SVCD)

Using the Disc Menu

Depending on the disc, a menu may appear on the TV screen once you load in the disc.

To select a playback feature or item

- Use ◀▶▲▼ keys or **numeric keypad (0-9)** on the remote, then press **OK** to start playback.

To access or remove the menu

- Press **DISC MENU** on the remote.

Zooming in

This function allows you to enlarge the picture on the TV screen and to pan through the enlarged picture.

- 1 During playback, press **ZOOM** repeatedly to display the picture with different scales.
 - Use ◀▶▲▼ keys to pan through the enlarged picture.
 - Playback will continue.
- 2 Press **ZOOM** repeatedly to return to the original size.

Resuming playback from the last stopped point

Resume playback of the last 5 discs is possible, even if the disc was ejected or the power switched off.

- Load one of the last 5 discs.
 - "LOAD" appears.
- Press **PLAY ▶** and the disc will be played back from the last point.

To cancel resume mode

- In stop mode, press **STOP ■** again.

Slow Motion

- 1 Press ▲▼ during playback to select the required speed: 1/2, 1/4, 1/8 or 1/16 (backward or reverse).
 - Sound will be muted.
- 2 To return to normal speed, press **PLAY ▶**.

Helpful Hint:

- Slow reverse is not possible on VCDs.

Using the OSD menu

OSD menu shows the disc playback information (for example, title or chapter number, elapsed playing time, audio/subtitle language), a number of operations can be done without interrupting disc playback.

- 1 During playback, press **DISPLAY**.
 - A list of available disc information appears on the TV screen.

Menu	
Title	01/01
Chapter	09/12
Audio	2CH Chinese
Subtitle	Off
Bitrate 61 ██████████ Title Remain 0:48:59	

Menu	
Track	01/01
Disc Time	0:48:53
Track Time	0:48:53
Repeat	Off
Bitrate 71 ██████████ Total Elapsed 0:01:32	

- 2 Press ▲▼ to view the information and press **OK** to access.
- 3 Press ▶ or **OK** to select an option.
- 4 Use the **numeric keypad (0-9)** to input the number/time or press ▲▼ to make the selection, then press **OK** to confirm.
 - Playback will change to the chosen time or to the selected title/chapter/track.

TIPS: The operating features described here might not be possible for certain discs. Always refer to the instructions supplied with the discs.

Disc Operations

English

Special DVD Features

Playing a Title

- 1 Press **DISC MENU**.
→ The disc menu appears on the TV screen.
- 2 Use **▲ ▼ ◀ ▶** keys or **numeric keypad (0-9)** to select a play option.
- 3 Press **OK** key to confirm.

Camera Angle

- Press **ANGLE** repeatedly to select different desired angle.

Changing the Audio Language

For DVD

- Press **AUDIO** repeatedly to select different audio languages.

Changing the Audio Channel

For VCD

- Press **AUDIO** to select the available audio channels provided by the disc (MONO LEFT, MONO RIGHT, MIX-MONO, STEREO).

Subtitles

- Press **SUBTITLE** repeatedly to select different subtitle languages.

Special VCD & SVCD Features

Playback Control (PBC)

For VCD with Playback Control (PBC) feature (version 2.0 only)

- Press **DISC MENU** to toggle between 'PBC ON' and 'PBC OFF'.
→ If you select 'PBC ON', the disc menu (if available) will appear on the TV.
→ Use the **◀◀ / ▶▶** or the numeric keypad (0-9) to select a play option.
- During playback, pressing **RETURN/TITLE** will return to the menu screen (if PBC is on).

If you want to skip the index menu and playback directly from the beginning,

- Press **DISC MENU** key on the remote control to switch to PBC off.

TIPS: The operating features described here might not be possible for certain discs. Always refer to the instructions supplied with the discs.

Disc Operations

Preview Function (DVD/VCD)

The preview function allows you to reduce the picture of 6 tracks enough to display in a full screen.

- 1 Press **PREVIEW**.
→ The preview menu appears on the TV screen.

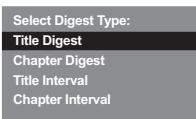

(DVD example)

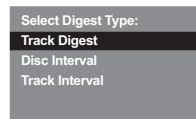

(Video CD example)

- 2 Press **▲▼** to select the **PREVIEW** type, then press **OK**.
→ The picture of each segment will appear on the screen.

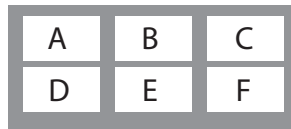

(example for 6 thumbnail pictures display)

- 3 Press **▲▼◀▶** to select a track and input your selected track number using the numeric keypad (0-9), then press **OK**.
→ Playback will start automatically on the selected track.
- For CDDA (Musical CD)
→ Press **PREVIEW** to listen to the first 6 seconds of each sound track in the disc.

TIPS: The operating features described here might not be possible for certain discs. Always refer to the instructions supplied with the discs.

Disc Operations

Playing MP3/JPEG/Kodak Picture CD

IMPORTANT!

You have to turn on your TV and set to the correct Video In channel. (See page 14 "Setting up the TV").

General Operation

- 1 Load a disc.
 - The disc reading time may exceed 30 seconds due to the complexity of the directory/file configuration.
 - The data disc menu appears on the TV screen.
- 2 Playback will start automatically. If not press **PLAY** ▶.

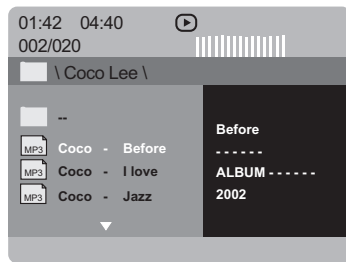

Selecting a folder and track/file

- 1 Press ▲ ▼ to select the folder and press **OK** to open the folder.
 - 2 Press ▲ ▼ to select a track/file.
 - 3 Press |◀◀ / ▶▶| to go to previous/next page.
 - 4 Press **OK** to confirm.
 - Playback will start from the selected file to the end of the folder.
- To select another folder from the current disc, press ◀ to return to the root menu, then press ▲ ▼ to make your selection and press **OK** to confirm.

During playback, you can;

- Press |◀◀ / ▶▶| to select another track/file in the current folder.
- Press **REPEAT** continuously to access different 'Play Mode'.
 - **SINGLE**: play the selected file once, then return to the menu.
 - **FOLDER**: files will be played back once.
 - **REPEAT ONE**: one file being played repeatedly.
 - **REPEAT FOLDER**: all files in one folder being played repeatedly.
 - **SHUFFLE**: all files in the current folder being played at random order.
- Press **||** to pause playback.

Helpful Hints:

- It may not be possible to play certain MP3/JPEG disc due to the configuration and characteristics of the disc or condition of the recording.
- It is normal to experience an occasional "skip" while listening to your MP3 disc.
- For multi-session discs with different formats, only the first session will be available.

TIPS: The operating features described here might not be possible for certain discs. Always refer to the instructions supplied with the discs.

Disc Operations

Special picture disc features

IMPORTANT!

You have to turn on your TV and set to the correct Video In channel. (See page 14 "Setting the TV").

- Load a Picture disc (Kodak Picture CD, JPEG).
 - For Kodak disc, the slide show will begin.
 - For JPEG disc, the picture menu appears on the TV screen. Press **PLAY** ► to start the slide-show playback.

Preview Function (JPEG)

This function shows the content of the current folder or the whole disc.

- 1 Press **PREVIEW** during playback.
 - 12 thumbnail pictures will appear on the TV screen.



- 2 Press ◀◀ / ▶▶ to display the other pictures on the previous/next page.
- 3 Use ◀▶ ▲ ▼ to highlight one of the picture and press **OK** to start playback.
- 4 Press **DISC MENU** to return to Picture CD menu.

Zoom picture

- 1 During playback, press **ZOOM** repeatedly to display the picture with different scales.
- 2 Use ◀▶ ▲ ▼ keys to view the zoomed picture.

Playback with multi-angles

- During playback, press ▲ ▼ ◀▶ to rotate the picture on the TV screen.
 - ▲: flip the picture vertically
 - ▼: flip the picture horizontally
 - ◀: rotate the picture anti-clockwise
 - ▶: rotate the picture clockwise

Scan Effect

- Press **ANGLE** repeatedly to choose different scan effect.
 - Various scan effect appears on the top left hand corner on the TV screen.

TIPS: The operating features described here might not be possible for certain discs. Always refer to the instructions supplied with the discs.

Karaoke Operations

Playing Karaoke discs

IMPORTANT!

You have to turn on your TV and set to the correct Video In channel. (See page 14 "Setting up the TV").

General Operation

- 1 Connect a microphone (not supplied) to MIC on the side panel of the DVD player.

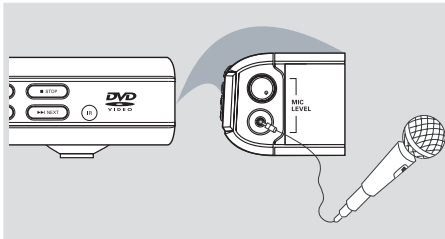

- 2 Press **KARAOKE** repeatedly.
→ 'MIC ON/OFF' appears on the TV screen.
- 3 Load a karaoke disc and press **PLAY** ►.
- 4 Adjust the microphone volume using **MIC LEVEL** button on the side panel of the DVD player.

Helpful Hint:

– Before connecting the microphone, set the microphone volume to the minimum level to prevent howling.

Key setting

- This function allows you to adjust the key tone level to match with your vocal.
- Press **KEY** and use ◀▶ to adjust the pitch to adopt your voice.

Vocal

- You can fade out the original vocal from a karaoke disc.
- Press **VOCAL** repeatedly to choose different audio modes.

Helpful Hint:

– This function and on screen display depends on the availability of the disc.

Mode

- Press **MODE** repeatedly to toggle between 'Vol', 'Echo' or 'Key'.
- 1 When 'Vol' is selected, press ◀▶ to adjust the vocal value between 0 and 20.
 - 2 When 'Echo' is selected, press ◀▶ to adjust the echo value between 0 and 20.
 - 3 When 'Key' is selected, press ◀▶ to adjust the pitch value between -16 and 16.

DVD Setup Menu Options

This DVD Player setup is carried out via the TV, enabling you to customise the DVD Player to suit your particular requirements.

General Setup menu

- 1 In disc mode, press **SYSTEM MENU**.
- 2 Press **◀▶** to select 'General Setup' icon.
- 3 Press **OK** to confirm.

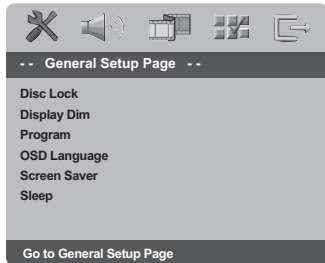

Locking/Unlocking the disc for viewing

Not all discs are rated or coded by the disc maker. You can prevent a specific disc from playing by locking the disc. Up to 40 discs can be locked.

- 1 In 'GENERAL SETUP PAGE', press **▲▼** to highlight {DISC LOCK}, then press **▶**.

LOCK

Select this to block the playback of the current disc. Subsequent access to a locked disc requires six-digit password. The default password is '136 900' (see page 35 "Changing the password").

UNLOCK

Select this to unlock the disc and allow future playback.

- 2 Press **▲▼** to select a setting, then press **OK** to confirm your selection.

TIPS: To return to the previous menu, press **◀**.
To remove the menu, press **SYSTEM MENU**.

Dimming player's display panel

You can select different levels of brightness for the display screen.

- 1 In 'GENERAL SETUP PAGE', press **▲▼** to highlight {DISPLAY DIM}, then press **▶**.
100% – Select this for full brightness.
70% – Select this for medium brightness.
40% – Select this for dimming the display.
- 2 Press **▲▼** to select a setting, then press **OK** to confirm your selection.

Programming disc tracks (not for Picture CD/MP3)

You can play the contents of the disc in the order you want by programming the tracks to be played. Up to 20 tracks can be stored.

- 1 In 'GENERAL SETUP PAGE', press **▲▼** to highlight {PROGRAM}, then press **▶** to select {INPUT MENU}.
- 2 Press **OK** to confirm.

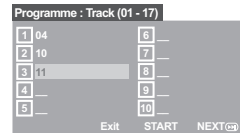

To input your favourite tracks/chapter

- 3 Use the **numeric keypad (0-9)** to enter a valid track/chapter number.
- 4 Use **◀▶▲▼** keys to move the cursor to the next position.
→ If the track number is more than ten, press **▶▶▶** to open the next page and proceed with programming or,
→ Use **◀▶▲▼** keys to highlight {NEXT} on the programme menu, then press **OK**.
- 5 Repeat steps **3~4** to input another track/chapter number.

DVD Setup Menu Options

If you want to remove a track

- Use ◀▶▲▼ keys to move the cursor to the track you want to remove.
- Press **OK** to remove this track from the programme menu.

To start programme playback

- Use ◀▶▲▼ keys to highlight {START} on the programme menu, then press **OK**.
→ Playback will start with the selected tracks under the programmed sequence.

To exit programme playback

- Use ◀▶▲▼ keys to highlight {EXIT} on the programme menu, then press **OK**.

OSD Language

This menu contains various language options for display language on the screen. For details, see page 17.

Screen Saver - turning on/off

The screen saver will help to prevent your TV display device from becoming damaged.

- In 'GENERAL SETUP PAGE', press ▲▼ to highlight {SCREEN SAVER}, then press ▶.

ON

Select this if you wish to turn off the TV screen when disc playback is stopped or paused for more than 15 minutes.

OFF

Select this to disable the screen saver function.

- Press ▲▼ to select a setting, then press **OK** to confirm your selection.

Sleep

Sleep function allows you to turn off the DVD Player automatically after a preset time.

- In 'GENERAL SETUP PAGE', press ▲▼ to highlight {SLEEP}, then press ▶.

15 Mins

Turn off the DVD Player after 15 minutes.

30 Mins

Turn off the DVD Player after 30 minutes.

45 Mins

Turn off the DVD Player after 45 minutes.

60 Mins

Turn off the DVD Player after 60 minutes.

OFF

Turn off the sleep function.

- Press ▲▼ to select a setting, then press **OK** to confirm your selection.

TIPS: To return to the previous menu, press ◀.
To remove the menu, press **SYSTEM MENU**.

DVD Setup Menu Options

Audio Setup Menu

- 1 In disc mode, press **SYSTEM MENU**.
- 2 Press ◀▶ to select 'Audio Setup' icon.
- 3 Press **OK** to confirm.

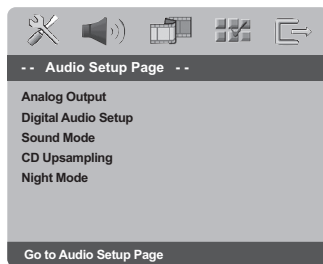

Analog Output

This options allows you to set the stereo analog output of your DVD Player.

- 1 In 'AUDIO SETUP PAGE', press ▲▼ to highlight {ANALOG OUTPUT}, then press ▶.

Stereo

Select this option when output delivers sound from only the two front speakers.

LT/RT

Select this option if your DVD Player is connected to a Dolby Pro Logic decoder.

V SURR

Allows the DVD player to use virtual surround sound effects.

- 2 Press ▲▼ to select a setting, then press **OK** to confirm your selection.

Digital Audio Setup

The options included in Digital Audio Setup are: 'Digital Output' and 'LPCM Output'.

- 1 In 'AUDIO SETUP PAGE', press ▲▼ to highlight {DIGITAL AUDIO SETUP}, then press ▶.
- 2 Press the ▲▼ keys to highlight an option.
- 3 Enter its submenu by pressing ▶.
- 4 Press ▲▼ to select a setting, then press **OK** to confirm your selection.

Digital Output

Set the Digital output according to your optional audio equipment connection.

→ **All**: If you have connected your DIGITAL AUDIO OUT to a multi-channel decoder/receiver.

→ **PCM Only**: Only if your receiver is not capable of decoding multi-channel audio.

Helpful Hints:

– If DIGITAL OUTPUT is set to 'All', all audio settings except MUTE are invalid.

LPCM Output

If you connect the DVD Player to a PCM compatible receiver via the digital terminals, such as coaxial or optical etc, you may need to adjust 'LPCM Output'. Discs are recorded at a certain sampling rate. The higher the sampling rate, the better the sound quality.

→ **48kHz**: Playback a disc recorded at the sampling rate of 48kHz.

→ **96kHz**: Playback a disc recorded at the sampling rate of 96kHz that can only be achieved in Stereo-Classic (Flat) mode.

Helpful Hint:

– LPCM Output can be selected only when PCM Only is activated.

TIPS: To return to the previous menu, press ◀.
To remove the menu, press **SYSTEM MENU**.

DVD Setup Menu Options

Sound Mode

The options included in Sound Mode Setup are: '3D', 'Movie Mode' and 'Music Mode'.

- 1 In 'AUDIO SETUP PAGE', press ▲▼ to highlight {SOUND MODE}, then press ►.
- 2 Press the ▲▼ keys to highlight an option.
- 3 Enter its submenu by pressing ►.
- 4 Press ▲▼ to select a setting, then press **OK** to confirm your selection.

3D

This function provides a virtual surround sound experience using just two speakers.
→ **Off, Living Room, Hall, Arena and Church**

Movie Mode

Select a Sound Mode that matches the type of music you are playing. These preset Sound Modes adjust the frequency bands of the video to enhance your favourite movie sound track.
→ **Off, Sci-Fic, Action, Drama and Concert**

Music Mode

Select a Sound Mode that matches the type of music you are playing. These preset Sound Modes adjust the frequency bands of the audio to enhance your favourite music.
→ **Off, Digital, Rock, Classic and Jazz**

CD Upsampling

This feature allows you to convert your music CD to a higher sampling rate using sophisticated digital signal processing for better sound quality. If you have activated the upsampling, the player will automatically switch to stereo mode.

- 1 In 'AUDIO SETUP PAGE', press ▲▼ to highlight {CD UPSAMPLING}, then press ►.

OFF

Select this to disable CD-upsampling.

88.2 kHz (X2)

Select this to convert the sampling rate of the CDs twice higher than the original.

176.4 kHz (X4)

Select this to convert the sampling rate of the CDs four times higher than the original.

- 2 Press ▲▼ to select a setting, then press **OK** to confirm your selection.

Helpful Hint:

- CD upsampling feature is only applicable to stereo output setting.

TIPS: To return to the previous menu, press ◀.
To remove the menu, press **SYSTEM MENU**.

DVD Setup Menu Options

Night Mode - turning on/off

In this mode, the high volume outputs are softened and low volume outputs are brought upward to an audible level. It is useful for watching your favourite action movie without disturbing others at night.

- 1 In 'AUDIO SETUP PAGE', press ▲▼ to highlight {NIGHT MODE}, then press ►.

ON

Select this to level out the volume. This feature is only available for movies with Dolby Digital mode.

OFF

Select this when you want to enjoy the surround sound with its full dynamic range.

- 2 Press ▲▼ to select a setting, then press **OK** to confirm your selection.

Video Setup Menu

- 1 In disc mode, press **SYSTEM MENU**.
- 2 Press ◀▶ to select 'Video Setup' icon.
- 3 Press **OK** to confirm.

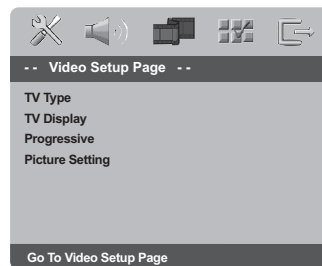

TV Type

This menu contains the options for selecting the colour system that matches the connected TV. For details, see page 16.

TIPS: To return to the previous menu, press ◀.
To remove the menu, press **SYSTEM MENU**.

DVD Setup Menu Options

Setting the TV Display

Set the aspect ratio of the DVD Player according to the TV you have connected. The format you select must be available on the disc. If it is not, the setting for TV display will not affect the picture during playback.

- 1 In 'VIDEO SETUP PAGE', press ▲▼ to highlight {TV DISPLAY}, then press ►.
- 2 Press ▲▼ to highlight one of the options below:

4:3 PAN SCAN –

Select this if you have a normal TV and want both sides of the picture to be trimmed or formatted to fit your TV screen.



4:3 LETTER BOX –

Select this if you have a normal TV. In this case, a wide picture with black bands on the upper and lower portions of the TV screen will be displayed.



16:9 – Select this if you have a wide-screen TV.



- 3 Select an item and press **OK**.

Progressive - turning on/off

In the progressive scan mode, you can enjoy the high quality picture with less flickers. It only works when you have connected the DVD player's Y Pb Pr jacks to your TV that supports the progressive video input. Otherwise, the a distorted picture will appear on the TV. For proper progressive scan set up, see page 16.

- 1 In 'VIDEO SETUP PAGE', press ▲▼ to highlight {PROGRESSIVE}, then press ►.

OFF

To disable Progressive Scan function.

ON

To enable Progressive Scan function.

- 2 Press ▲▼ to select a setting, then press **OK** to confirm your selection.
 - Follow the instructions shown on the TV to confirm the selection (if any).
 - If a distorted picture appears on the TV screen, wait for 15 seconds for auto recovery.

TIPS: To return to the previous menu, press ◀.
To remove the menu, press **SYSTEM MENU**.

DVD Setup Menu Options

Picture Setting

This DVD Player provides three predefined sets of picture colour settings and one personal setting which you can define yourself.

- 1 In 'VIDEO SETUP PAGE', press ▲▼ to highlight {PICTURE SETTING}, then press ►.

STANDARD

Select this for standard picture setting.

BRIGHT

Select this will make the TV picture brighter.

SOFT

Select this will make the TV picture softer.

PERSONAL

Select this to personalise your picture colour by adjusting the brightness, contrast, tint and colour (saturation).

- 2 Press ▲▼ to select a setting, then press **OK** to confirm your selection.

- 3 If you select {PERSONAL}, then proceed to steps 4~7.
→ The 'PERSONAL PICTURE SETUP' menu appears.

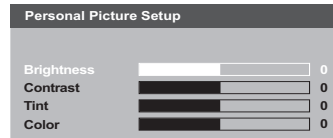

- 4 Press ▲▼ to highlight one of the following options.

BRIGHTNESS

Increase the value will brighten the picture or vice versa. Choose zero (0) for average setting.

CONTRAST

Increase the value will sharpen the picture or vice versa. Choose zero (0) to balance the contrast.

TINT

Increase the value will darken the picture or vice versa. Choose zero (0) for average setting.

COLOUR

Increase the value will enhance the colour in your picture or vice versa. Choose zero (0) to balance the colour.

- 5 Press ◀▶ to adjust the setting that best suit your personal preference.
- 6 Repeat steps 4~5 for adjusting other colour features.
- 7 Press **OK** to confirm.

TIPS: To return to the previous menu, press ◀.
To remove the menu, press **SYSTEM MENU**.

DVD Setup Menu Options

Preference Page

- 1 Press **■** twice to stop playback (if any), then press **SYSTEM MENU**.
- 2 Press **◀▶** to select the 'Preference Setup' icon.
- 3 Press **OK** to confirm.

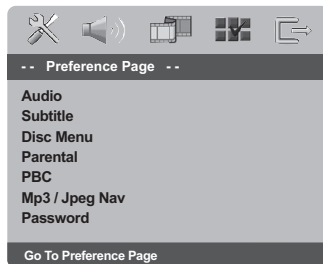

Audio, Subtitle, Disc Menu

These menus contain various language options for audio, subtitle and disc menu which may be recorded on the DVD. For details, see page 17.

Restricting playback by Parental Control

Some DVDs may have a parental level assigned to the complete disc or to certain scenes on the disc. This feature lets you set a playback limitation level. The rating levels are from 1 to 8 and are country dependent. You can prohibit the playing of certain discs that are not suitable for your children or have certain discs played with alternative scenes.

- 1 In 'PREFERENCE PAGE', press **▲▼** to highlight {PARENTAL}, then press **▶**.

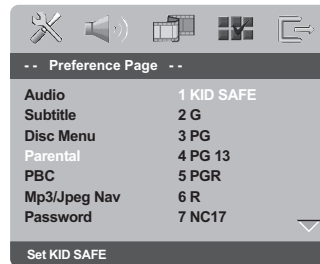

English

TIPS: To return to the previous menu, press **◀**.
To remove the menu, press **SYSTEM MENU**.

DVD Setup Menu Options

Restricting playback by Parental Control - cont'd

- 2 Press ▲ ▼ to highlight a rating level for the disc inserted and press **OK**.
→ To disable Parental controls and have all Discs play, select {8 ADULT}.
- 3 Use the **numeric keypad (0-9)** to enter the six-digit password (see page 35 "Changing the password").
→ DVDs that are rated above the level you selected will not play unless you enter your six-digit password.

Helpful Hints:

- VCD, SVCD, CD have no level indication, so parental control function has no effect on these type of discs. This applies to most illegal DVD discs.
- Some DVDs are not encoded with a rating though the movie rating may be printed on the Disc cover. The rating level feature does not work for such Discs.

PBC

You can set the PBC to ON or OFF. This feature is available only on Video CD 2.0 with playback control (PBC) feature. For details, see page 21.

MP3/JPEG Menu - turning on/off

MP3/JPEG Navigator can be set only if the disc is recorded with menu. It allows you to select different display menus for easy navigation.

- 1 In 'PREFERENCE PAGE', press ▲ ▼ to highlight {MP3/JPEG NAV}, then press ►.

WITHOUT MENU

Select this to display all the files contained in the MP3/Picture CD.

WITH MENU

Select this to display only the folder menu of the MP3/Picture CD.

- 2 Press ▲ ▼ to select a setting, then press **OK** to confirm your selection.

TIPS: To return to the previous menu, press ◀.
To remove the menu, press **SYSTEM MENU**.

DVD Setup Menu Options

Changing the Password

The same password is used for both Parental Control and Disc Lock. Enter your six-digit password when prompted on the screen. The default password is 136 900.

- 1 In 'PREFERENCE PAGE', press ▲▼ to highlight {PASSWORD}, then press ► to select {CHANGE}.



- 2 Use the **numeric keypad (0-9)** to enter your old six-digit password.
 - When doing this for the first time, key in '136 900'.
 - If you forget your old six-digit password, key in '136 900'.
- 3 Enter the new six-digit password.
- 4 Enter the new six-digit password a second time to confirm.
 - The new six-digit password will now take effect.
- 5 Press **OK** to confirm.

Restoring to original settings

Setting the DEFAULT function will reset all options and your personal settings to the factory defaults, except your password for Parental Control and Disc Lock.

- 1 In 'PREFERENCE PAGE', press ▲▼ to highlight {DEFAULT}, then press ► to select {RESET}.
- 2 Press **OK** to confirm.
 - All settings will now reset to factory defaults.

TIPS: To return to the previous menu, press ◀.
To remove the menu, press **SYSTEM MENU**.

Troubleshooting

WARNING

Under no circumstances should you try to repair the system yourself, as this will invalidate the warranty. Do not open the system as there is a risk of electric shock.

If a fault occurs, first check the points listed below before taking the system for repair. If you are unable to remedy a problem by following these hints, consult your dealer or Philips for help.

Problem	Solution
No power	<ul style="list-style-type: none"> – Check if the AC power cord is properly connected. – Press the STANDBY ON on the front of the DVD system to turn on the power.
No picture	<ul style="list-style-type: none"> – Refer to your TV's manual for correct Video In channel selection. Change the TV channel until you see the DVD screen. – Check if the TV is switched on. – If the progressive scan feature is activated but the connected TV does not support progressive signals or the cables are not connected accordingly, see page 16 for proper progressive scan set up or deactivate the progressive scan feature as below: <ol style="list-style-type: none"> 1) Turn off your TV progressive scan mode or turn on to interlaced mode. 2) Press OPEN/CLOSE to open the disc tray. 3) Press numeric keypad '1' on the remote control for few seconds.
Distorted picture	<ul style="list-style-type: none"> – Sometimes a small amount of picture distortion may appear depending on the disc being played back. This is not a malfunction.
Completely distorted picture or black/white picture with DVD	<ul style="list-style-type: none"> – Connect DVD Player directly to the TV. – Make sure the disc is compatible with the DVD/ Player. – Ensure that the DVD Player's TV Type is set to match that of the Disc and your TV.
No sound or distorted sound	<ul style="list-style-type: none"> – Adjust the volume. – Check that the speakers are connected correctly.
No audio at digital output	<ul style="list-style-type: none"> – Check the digital connections. – Check if your receiver can decode MPEG-2 or DTS and if not, please make sure the digital output is set to PCM. – Check if the audio format of the selected audio language matches your receiver capabilities.

Visit us at www.philips.com/support for service support

Troubleshooting

Problem	Solution
Disc can't be played	<ul style="list-style-type: none">– The DVD+R/CD-R must be finalised.– Ensure the disc label is facing up.– Check if the disc is defective by trying another disc.– Region code incorrect.
Picture freezes momentarily during playback	<ul style="list-style-type: none">– Check the disc for fingerprints/scratches and clean with a soft cloth wiping from centre to edge.
No return to start-up screen when disc is removed	<ul style="list-style-type: none">– Reset the unit by switching the player off, then on again.
The player does not respond to the Remote Control	<ul style="list-style-type: none">– Aim the Remote Control directly at the sensor on the front of the player.– Reduce the distance to the player.– Replace the batteries in the Remote Control.– Re-insert the batteries with their polarities (+/– signs) as indicated.
Buttons do not work	<ul style="list-style-type: none">– To completely reset the player, unplug the AC cord from the AC outlet for 5-10 seconds.
Player does not respond to some operating commands during playback.	<ul style="list-style-type: none">– Operations may not be permitted by the disc. Refer to the instructions of the disc jacket.
DVD Player cannot read CDs/DVDs	<ul style="list-style-type: none">– Use a commonly available cleaning CD/DVD to clean the lens before sending the DVD Player for repair.
Menu items cannot be selected	<ul style="list-style-type: none">– Press STOP twice before selecting System Menu.– Depending on the disc availability, some menu items cannot be selected.
Unable to select Progressive Scan on/off	<ul style="list-style-type: none">– Check that the output of the video signal is switch to 'YUV'.

English

Visit us at www.philips.com/support for service support

Specifications

TV STANDARD (PAL/50Hz) (NTSC/60Hz)

Number of lines	625	525
Playback	Multistandard	(PAL/NTSC)

VIDEO PERFORMANCE

Video DAC	12 bit, 108MHz	
YPbPr	0.7 Vpp — 75 ohm	
Video Output	1Vpp — 75 ohm	

VIDEO FORMAT

Digital Compression	MPEG 2 for DVD,SVCD MPEG 1 for VCD	
---------------------	---------------------------------------	--

	50Hz	60Hz
Horiz. resolution	720 pixels	720 pixels
Vertical resolution	576 lines	480 lines

	50Hz	60Hz
Horiz. resolution	352 pixels	352 pixels
Vertical resolution	288 lines	240 lines

AUDIO FORMAT

Digital	MPEG/ AC-3/ PCM	compressed Digital 16, 20, 24 bits fs, 44.1, 48, 96 kHz
	MP3(ISO 9660)	96, 112, 128, 256 kbps & variable bit rate fs, 32, 44.1, 48 kHz

Analog Sound Stereo
Dolby Surround compatible downmix from Dolby Digital
multi-channel sound

AUDIO PERFORMANCE

DA Converter	24 bit, 192 kHz	
DVD	fs 96 kHz	4Hz- 44kHz
	fs 48 kHz	4Hz- 22kHz
SVCD	fs 48 kHz	4Hz- 22kHz
	fs 44.1kHz	4Hz- 20kHz
CD/VCD	fs 44.1kHz	4Hz- 20kHz
Signal-Noise (1kHz)	> 95 dB	
Dynamic range(1kHz)	> 85 dB	
Crosstalk (1kHz)	> 90 dB	
Distortion/noise (1kHz)	> 80 dB	
MPEG MP3	MPEG Audio L3	

CONNECTIONS

YPbPr Output	Cinch 3x
Video Output	Cinch (yellow)
Audio Output(L+R)	Cinch (white/red)
Digital Output	1 coaxial
	IEC60958 for CDDA / LPCM
	IEC61937 for MPEG 1/2,
	Dolby Digital

CABINET

Dimensions (w x h x d)	360 x 37 x 265 mm
Weight	Approximately 2.0 kg

POWER CONSUMPTION

Power Supply Rating	240V; 50Hz
Power consumption	< 10 W
Power consumption in Standby mode	< 0.8 W

Specifications subject to change without prior notice

Glossary

Analog: Sound that has not been turned into numbers. Analog sound varies, while digital sound has specific numerical values. These jacks send audio through two channels, the left and right.

Aspect ratio: The ratio of vertical and horizontal sizes of a displayed image. The horizontal vs. vertical ratio of conventional TVs is 4:3, and that of wide-screens is 16:9.

AUDIO OUT Jacks: Jacks on the back of the DVD System that send audio to another system (TV, Stereo, etc.).

Bit Rate: The amount of data used to hold a given length of music; measured in kilobits per seconds, or kbps. Or, the speed at which you record. Generally, the higher the bit rate, or the higher the recording speed, the better the sound quality. However, higher bit rates use more space on a Disc.

Chapter: Sections of a picture or a music piece on a DVD that are smaller than titles. A title is composed of several chapters. Each chapter is assigned a chapter number enabling you to locate the chapter you want.

Component Video Out Jacks: Jacks on the back of the DVD System that send high-quality video to a TV that has Component Video In jacks (R/G/B, Y/Pb/Pr, etc.).

Disc menu: A screen display prepared for allowing selection of images, sounds, subtitles, multi-angles, etc recorded on a DVD.

Digital: Sound that has been converted into numerical values. Digital sound is available when you use the DIGITAL AUDIO OUT COAXIAL or OPTICAL jacks. These jacks send audio through multiple channels, instead of just two channels as analog does.

Dolby Digital: A surround sound system developed by Dolby Laboratories containing up to six channels of digital audio (front left and right, surround left and right, center and subwoofer).

DTS: Digital Theatre Systems. This is a surround sound system, but it is different from Dolby Digital. The formats were developed by different companies.

JPEG: A very common digital still picture format. A still-picture data compression system proposed by the Joint Photographic Expert Group, which features small decrease in image quality in spite of its high compression ratio.

MP3: A file format with a sound data compression system. "MP3" is the abbreviation of Motion Picture Experts Group 1 (or MPEG-1) Audio Layer 3. By using MP3 format, one CD-R or CD-RW can contain about 10 times as much data volume as a regular CD can.

Multichannel: DVD is specified to have each sound track constitute one sound field. Multichannel refers to a structure of sound tracks having three or more channels.

Parental Control: A function of the DVD to limit playback of the disc by the age of the users according to the limitation level in each country. The limitation varies from disc to disc; when it is activated, playback will be prohibited if the software's level is higher than the user-set level.

PCM (Pulse Code Modulation): A system for converting analog sound signal to digital signal for later processing, with no data compression used in conversion.

Playback control (PBC): Refers to the signal recorded on video CDs or SVCDs for controlling reproduction. By using menu screens recorded on a Video CD or SVCD that supports PBC, you can enjoy interactive-type software as well as software having a search function.

Progressive Scan: It displays all the horizontal lines of a picture at one time, as a signal frame. This system can convert the interlaced video from DVD into progressive format for connection to a progressive display. It dramatically increases the vertical resolution.

Region code: A system for allowing discs to be played back only in the region designated beforehand. This unit will only play discs that have compatible region codes. You can find the region code of your unit by looking on the product label. Some discs are compatible with more than one region (or ALL regions).

Surround: A system for creating realistic three-dimensional sound fields full of realism by arranging multiple speakers around the listener.

Title: The longest section of a picture or music feature on DVD, music, etc., in video software, or the entire album in audio software. Each title is assigned a title number enabling you to locate the title you want.

VIDEO OUT jack: Jack on the back of the DVD System that sends video to a TV.



Meet Philips at the Internet
<http://www.philips.com/support>

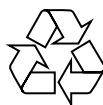
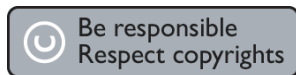

DVP 3005K



3139 246 15791



sgpSL-0520/13-2



3139 246 15791