

Quick Start Guide



Step A *Connect*

Step B *Setup*

Step C *Enjoy*

What's in the Box?

You should find these items upon opening the box.

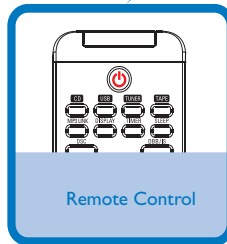
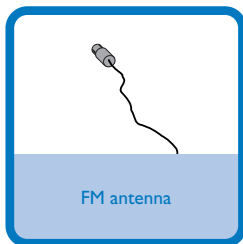

Pull out the plastic protective sheet before use.

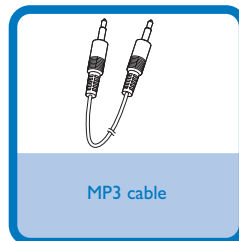
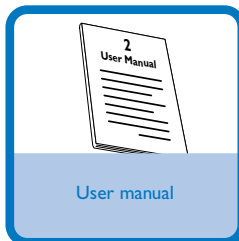
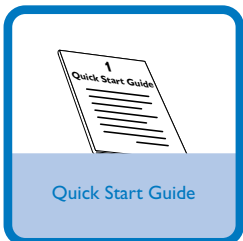
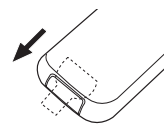

PHILIPS

Step A **Connect**

1

Connect the speaker cables.

2

Connect the FM antennas.

3

Connect the power cable of the system.

Tip

See the User Manual for how to connect other equipment to this system.

Warning!

If your system is equipped with a voltage selector, set the **VOLTAGE SELECTOR** to the local power voltage.

Note:

There are two groups of wires for each speaker box, one is blue-black wire for high frequency (connect the blue wire to "+" and the black one to "-"), and the other is red-black wire for low frequency (connect the red wire to "+" and black one to "-").

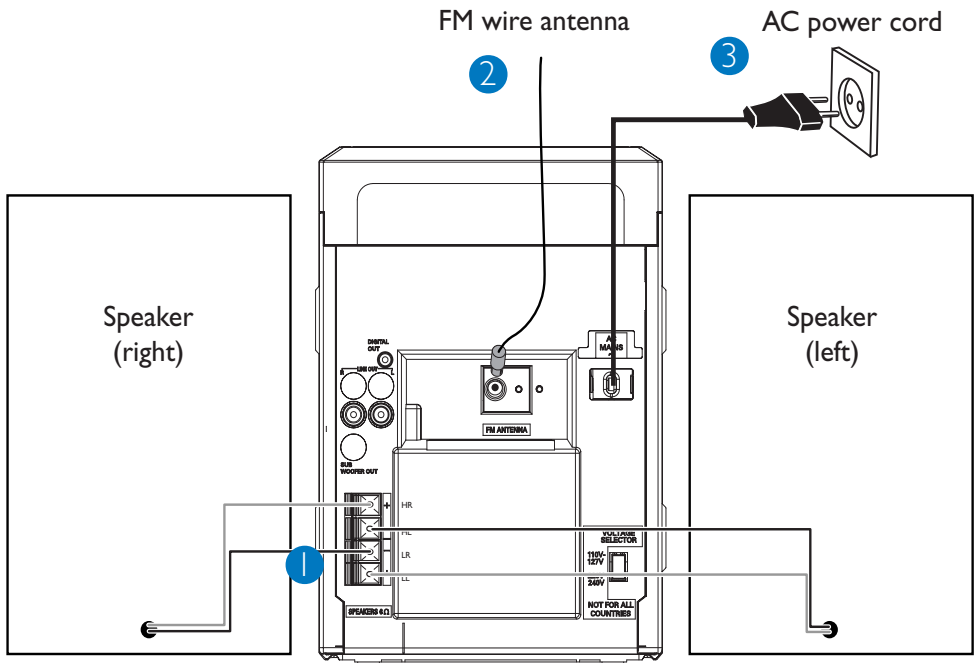

Step B Setup

Setting the clock

1

In standby mode, press and hold **CLOCK SET** on the system.

2

When the hour digits flash, turn the **VOLUME** control on the front panel to set the hours.

3

Press **CLOCK SET** again and the minute digits flash. Then turn the **VOLUME** control on the front panel to set the minutes.

4

Press **CLOCK SET** again to confirm the time setting.

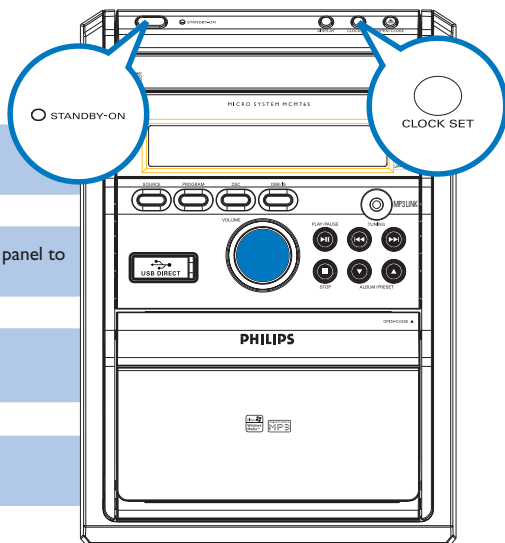

Notes for remote control:

- First select the source you wish to control by pressing one of the source select keys on the remote control (for example iPod, TUNER).
- Then select the desired function (for example ►||, ◀◀◀, ▶▶▶).

Step C Enjoy

Playing a disc

1

Press **OPEN/CLOSE** ▲ to open the disc tray and load in a disc, then press the same button again to close the disc tray.
→ Make sure the label side of the disc is facing up.

2

Press ►|| to start playback.

3

To stop playback, press ■.

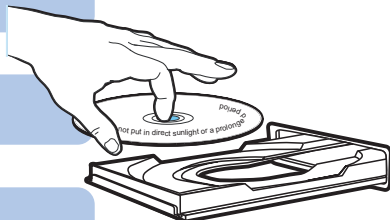

Playing a USB device

With the Hi-Fi system, you can use USB flash memory (USB 2.0 or USB1.1), USB flash players (USB 2.0 or USB1.1), memory cards (requires an additional card reader to work with this Hi-Fi system).

- 1 Insert the USB device's USB plug into the socket  on the set.
- 2 Press **SOURCE** once or more to select **USB** (or **USB** on the remote control).
- 3 Play the USB's audio files as you do with the albums/tracks on a CD.

Programming and tuning to radio stations

- 1 Press **SOURCE** repeatedly to select the tuner source.
- 2 Press **PROGRAM** for more than two seconds to program all available stations in order of waveband.
- 3 Press **▼** or **▲** until the desired preset station is displayed.

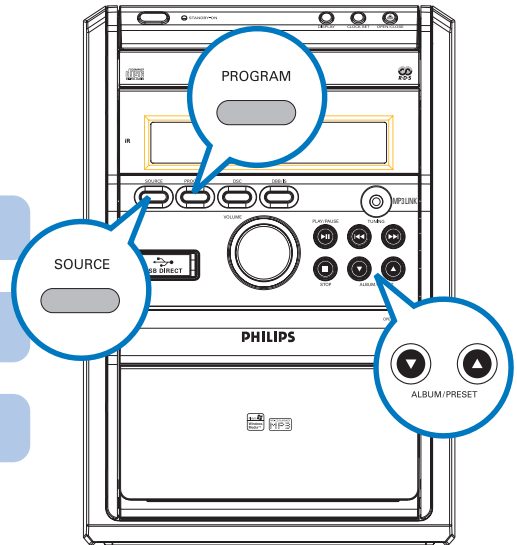

Tip
Detailed playback features and additional functions are described in the accompany owner's manual.

