

Always there to help you

Register your product and get support at
www.philips.com/support



HTD5520

HTD5550

HTD5580

Quick start guide

PHILIPS



EN Before using your product, read all accompanying safety information

ZH-CN 使用产品前，请阅读所有随附的安全信息



HTD5520

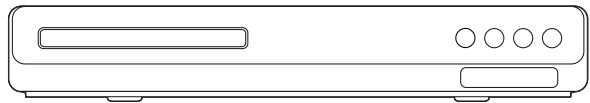
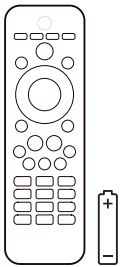

HDMI

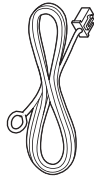

FM Antenna



MIC-IN Converter

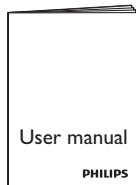
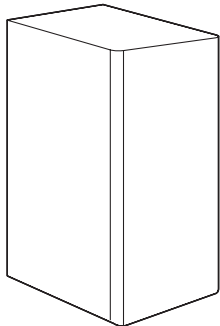
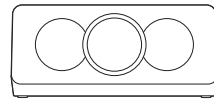

User manual

PHILIPS

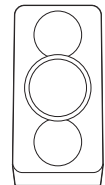
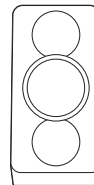
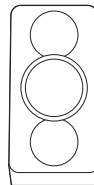
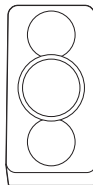

HTD5550

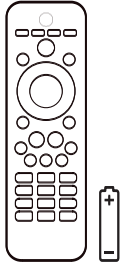

MIC-IN Converter

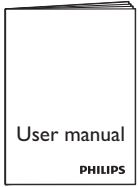

User manual

PHILIPS

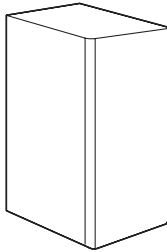

HDMI

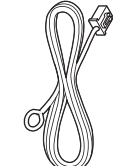

FM Antenna

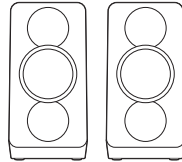
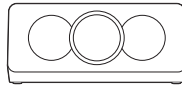

2x

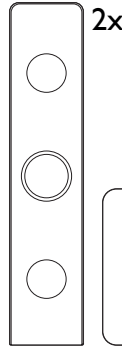

2x



6x



2x

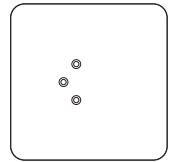

2x

HTD5580

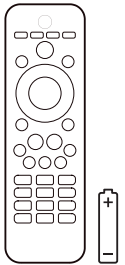

MIC-IN Converter



User manual

PHILIPS

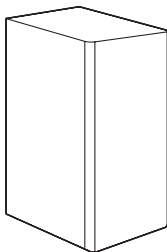

HDMI

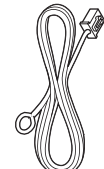

FM Antenna

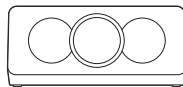

4x

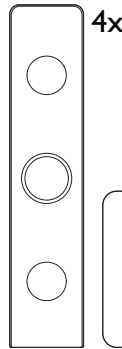

4x



12x



4x

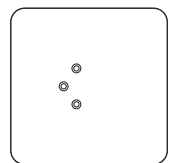

4x

1

EN Stand mount the speakers
(Applied to HTD5550 and HTD5580 only)

ZH-CN 将扬声器安装到立架上
(只适用于 HTD5550 和 HTD5580 的型号)

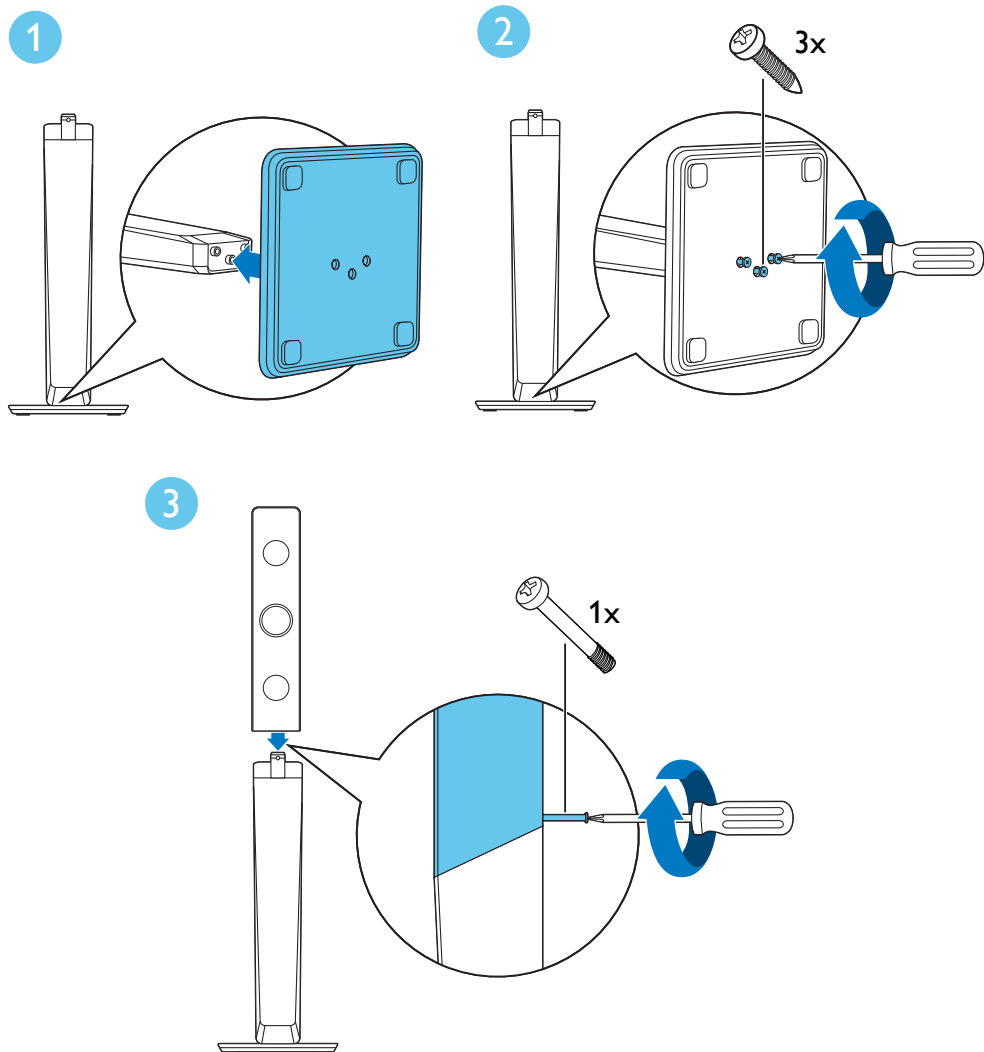

2

EN Connect and position the home theater

ZH-CN 连接和放置家庭影院

HTD5520

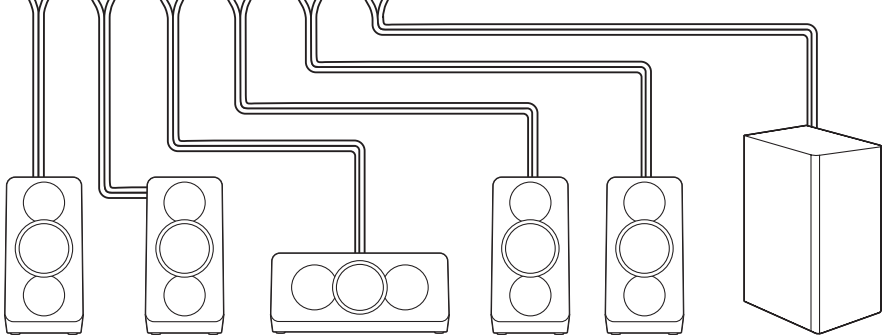
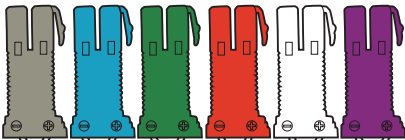
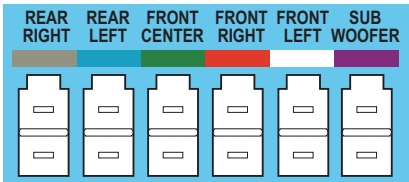
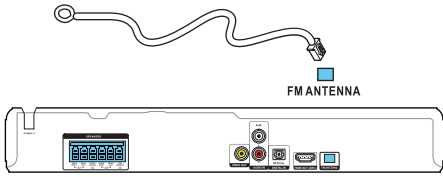

REAR RIGHT

REAR LEFT

FRONT CENTER

FRONT RIGHT

FRONT LEFT

SUB-WOOFER

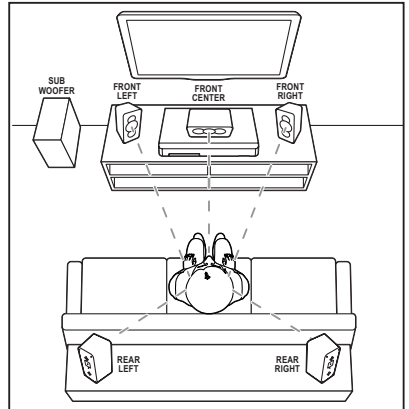

HTD5550

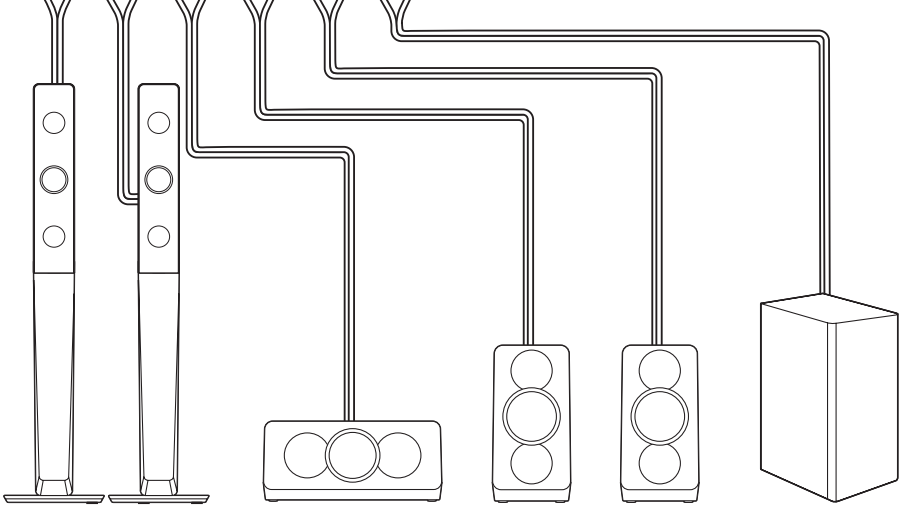
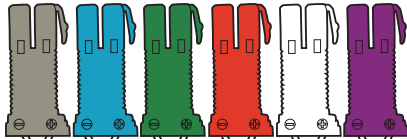
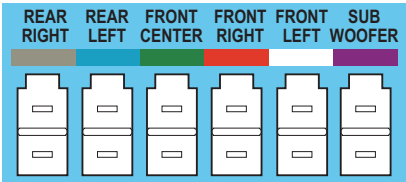
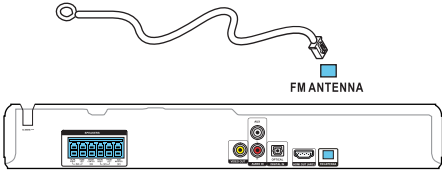

REAR RIGHT

REAR LEFT

FRONT CENTER

FRONT RIGHT

FRONT LEFT

SUB-WOOFER

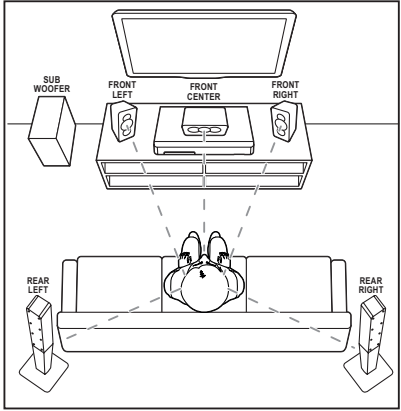

HTD5580

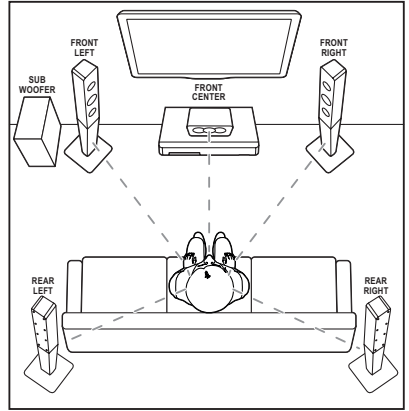
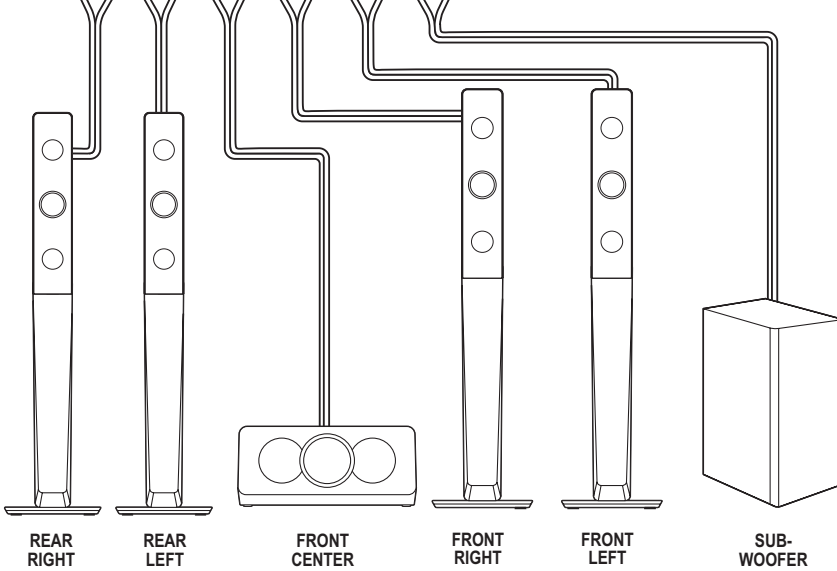
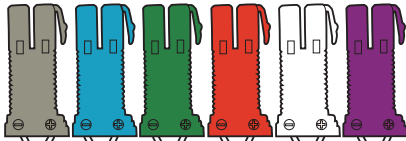
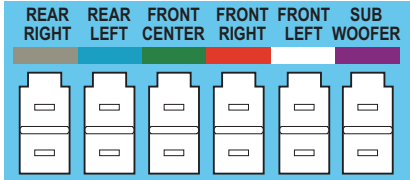
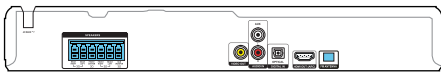

3

EN Connect to TV in one of these ways

ZH-CN 通过以下一种方式连接至电视

HDMI ARC

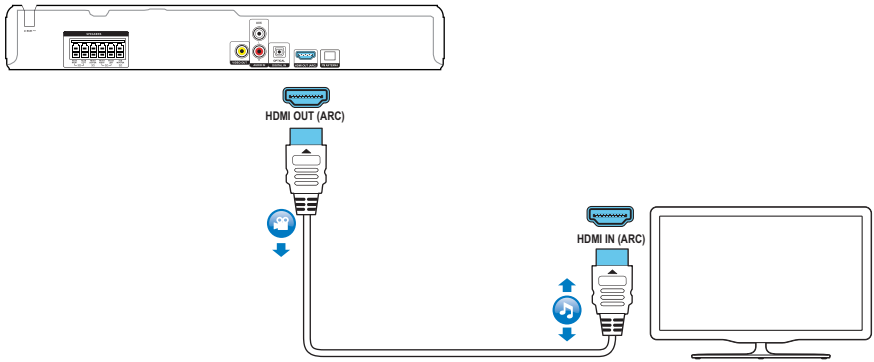

HDMI + OPTICAL

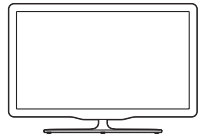
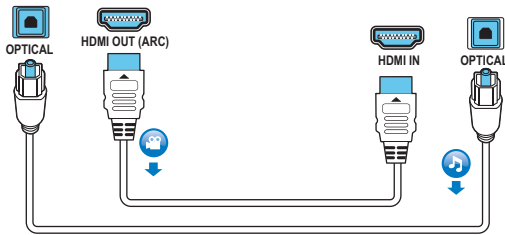
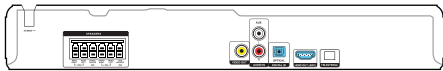

VIDEO + AUDIO L/R

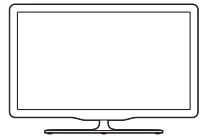
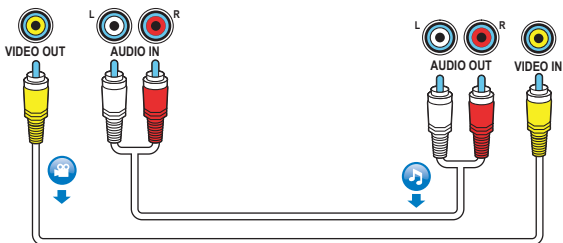
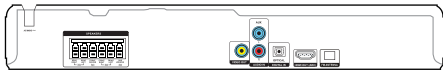

4

EN Switch on the home theater

ZH-CN 打开家庭影院

1

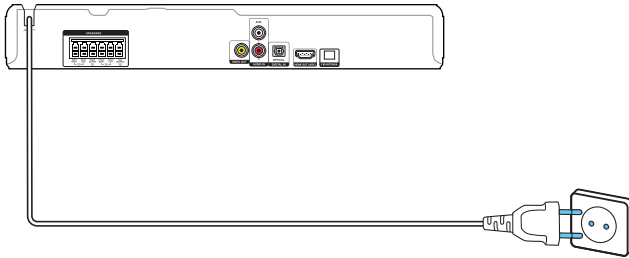

2

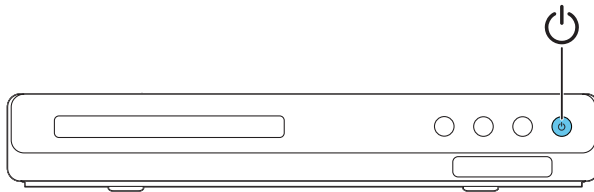

3

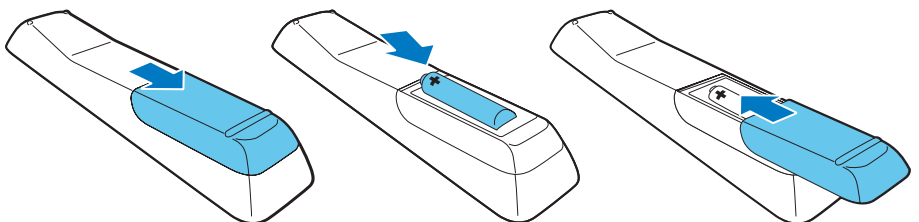

5

EN Complete the first time setup

ZH-CN 完成首次设置

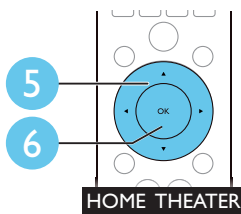
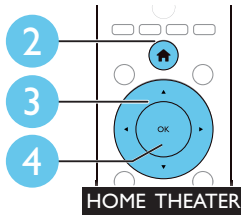
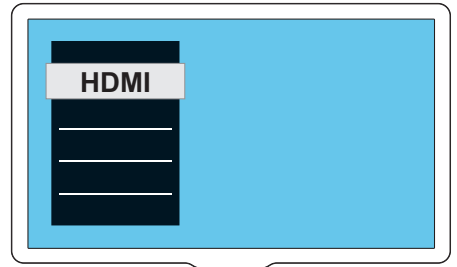
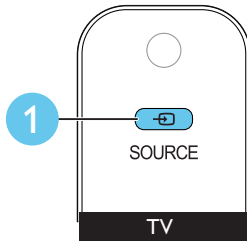

6

EN Use your home theater

ZH-CN 使用家庭影院

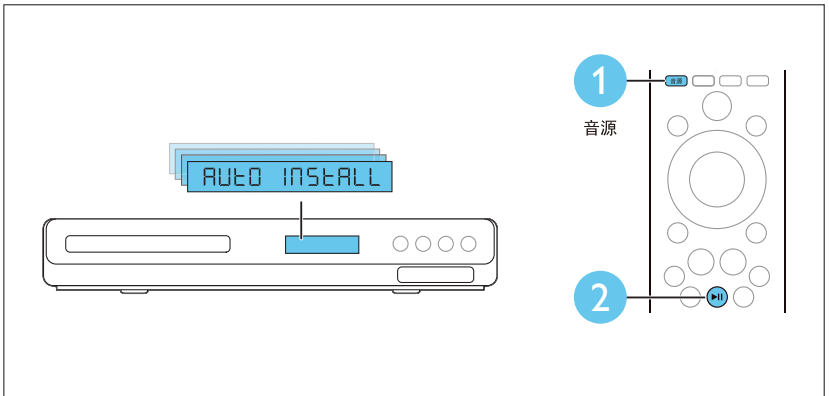
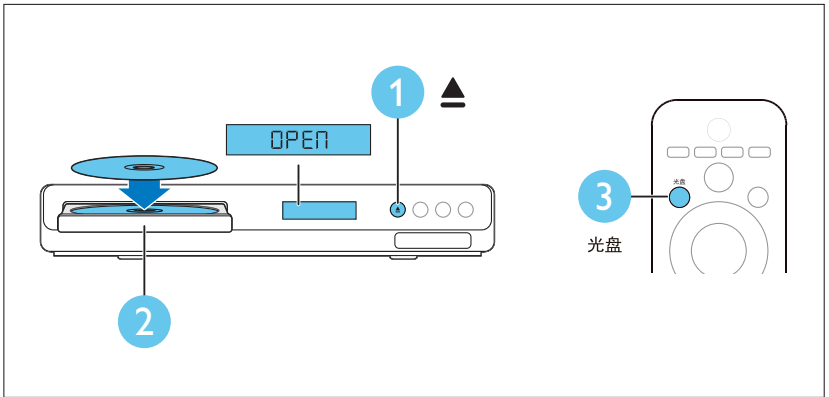

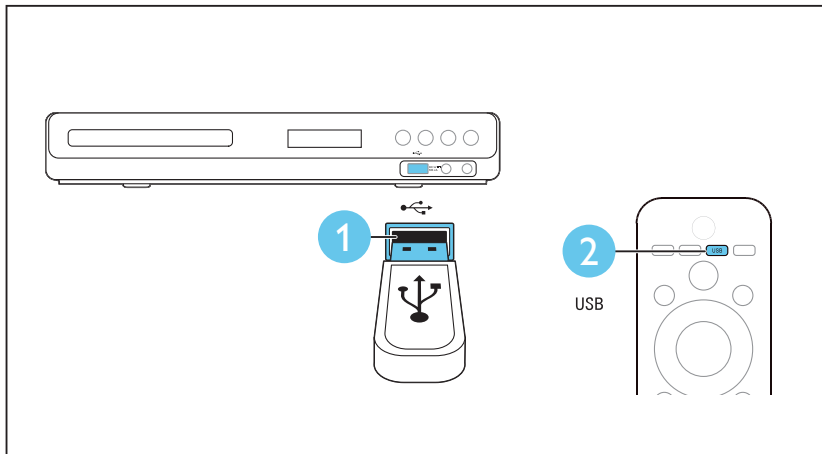
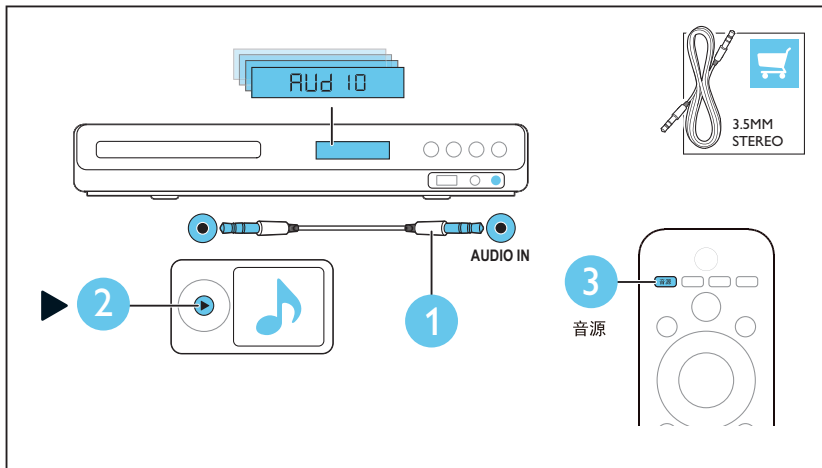

7

EN Play audio through Bluetooth

ZH-CN 通过蓝牙播放音频

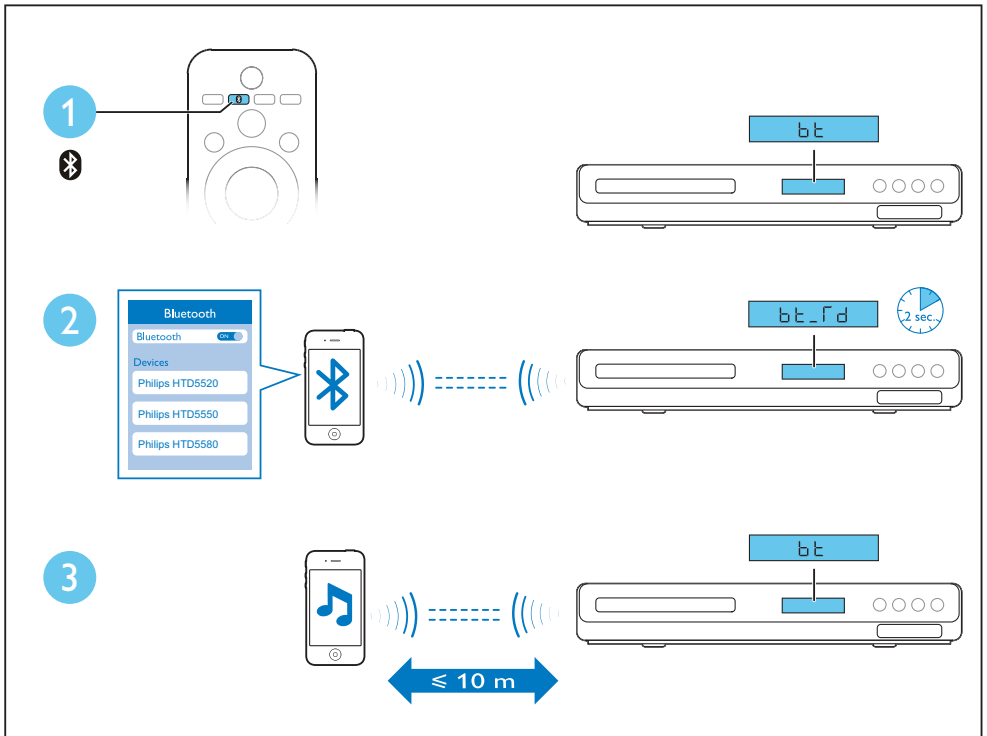



Specifications are subject to change without notice
© 2014 Koninklijke Philips N.V. All rights reserved.
Trademarks are the property of Koninklijke Philips N.V. or their respective owners.

HTD5520/HTD5550/HTD5580_93_QSG_V2.0

