

# Always there to help you

Register your product and get support at  
[www.philips.com/welcome](http://www.philips.com/welcome)



CE152G



User manual	1
Руководство пользователя	27
Посібник користувача	59

# PHILIPS

# Contents

<b>1</b>	<b>Safety</b>	<b>2</b>		
<b>2</b>	<b>Your car audio system</b>	<b>3</b>		
	Introduction	3		
	What's in the box	3		
	Overview of the system	4		
<b>3</b>	<b>Install the car audio system</b>	<b>6</b>		
	Connect wires	7		
	Mount into the dashboard	8		
	Attach the front panel	9		
<b>4</b>	<b>Get started</b>	<b>10</b>		
	For the first time use	10		
	Set the time format	10		
	Set the clock	10		
	Select a source	10		
	Select a listening zone	10		
	Mute the button beep	11		
<b>5</b>	<b>Listen to radio</b>	<b>11</b>		
	Switch to radio mode	11		
	Select a tuner region	11		
	Select a tuner sensitivity	11		
	Search for a radio station	12		
	Store radio stations in memory	12		
	Play with RDS	12		
<b>6</b>	<b>Play from a storage device</b>	<b>14</b>		
	Control play	15		
	Switch tracks	15		
<b>7</b>	<b>Play from an iPod/iPhone</b>	<b>16</b>		
	Compatible iPod/iPhone models	16		
	Connect your iPod/iPhone	16		
	Control play	16		
	Charge your iPod/iPhone	17		
<b>8</b>	<b>Use Bluetooth devices</b>	<b>17</b>		
	Connect a device	17		
	Play audio from a Bluetooth device	18		
	Make a call	18		
<b>9</b>	<b>Listen to an external player</b>	<b>19</b>		
<b>10</b>	<b>Adjust sound</b>	<b>20</b>		
<b>11</b>	<b>Additional information</b>	<b>20</b>		
	Reset the system	20		
	Replace the fuse	20		
<b>12</b>	<b>Product information</b>	<b>21</b>		
<b>13</b>	<b>Troubleshooting</b>	<b>22</b>		
	General	22		
	About the Bluetooth device	23		
<b>14</b>	<b>Notice</b>	<b>24</b>		
	Compliance	24		
	Care of the environment	24		
	Trademark notice	24		
	Copyright	25		

# 1 Safety

Read and understand all instructions before you use this device. If damage is caused by failure to follow instructions, the warranty does not apply.

- Modification of the product could result in hazardous radiation of EMC or other unsafe operation.
- The device is designed for negative ground (earth) 12V DC operation only.
- To ensure safe driving, adjust the volume to a safe and comfortable level.
- Improper fuses can cause damage or fire. When you need to change the fuse, consult a professional.
- Use only the supplied mounting hardware for a safe and secure installation.
- To avoid short circuits, do not expose the device to rain or water.
- The device shall not be exposed to dripping or splashing.
- Do not place any sources of danger on the device (e.g. liquid filled objects, lighted candles).
- Never insert objects into the ventilation slots or other openings on the device.
- Clean the device with soft, damp cloth. Never use substances such as alcohol, chemicals or household cleaners on the device.

## 2 Your car audio system

Congratulations on your purchase, and welcome to Philips! To fully benefit from the support that Philips offers, register your product at [www.philips.com/welcome](http://www.philips.com/welcome).

### Introduction

**With this system, you can:**

- enjoy audio from a USB storage device, SD/SDHC card, iPod/iPhone, and external player;
- charge your iPod/iPhone,
- listen to radio stations, and
- make phone calls via Bluetooth.

**You can enrich sound output with these sound effects:**

- Dynamic bass boost (DBB)
- Digital sound control (DSC)

**Playable media:**

- USB storage device
  - Compatibility: USB 2.0, USB 1.1
  - Class support: MSC (Mass Storage Class)
  - Maximum capacity: 32 GB
- SD/SDHC card
  - Maximum capacity: 32 GB
- Files
  - File system: FAT16, FAT32
  - Maximum number of folders: 99
  - Maximum number of tracks/files: 999
  - Maximum level of directory: 8
  - .mp3 files
    - Sampling frequencies: 32 kHz, 44.1 kHz, 48 kHz
    - Bitrates: 8-320 kbps and variable bitrates

- .wma files
  - Versions: V4, V7, V8, V9 (L1 and L2)
  - Sampling frequencies: 44.1 kHz, 48 kHz
  - Bitrates: 64-192 kbps and variable bitrates
- ID3 tag V2.0 or later
- **Unsupported files:**
  - AAC, WAV, and PCM files
  - DRM protected WMA files (.wav, .m4a, .m4p, .mp4, and .aac)
  - WMA files in lossless format

### What's in the box

Check and identify the contents of the package:

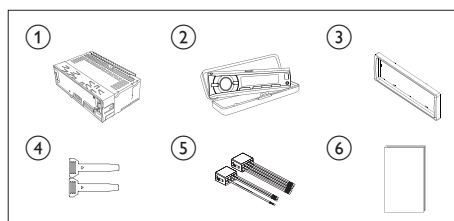

- ① Main unit (with a sleeve)
- ② Carrying case (with front panel included)
- ③ Trim plate
- ④ Disassembly tool X 2
- ⑤ ISO male connector X 2
- ⑥ User manual

# Overview of the system

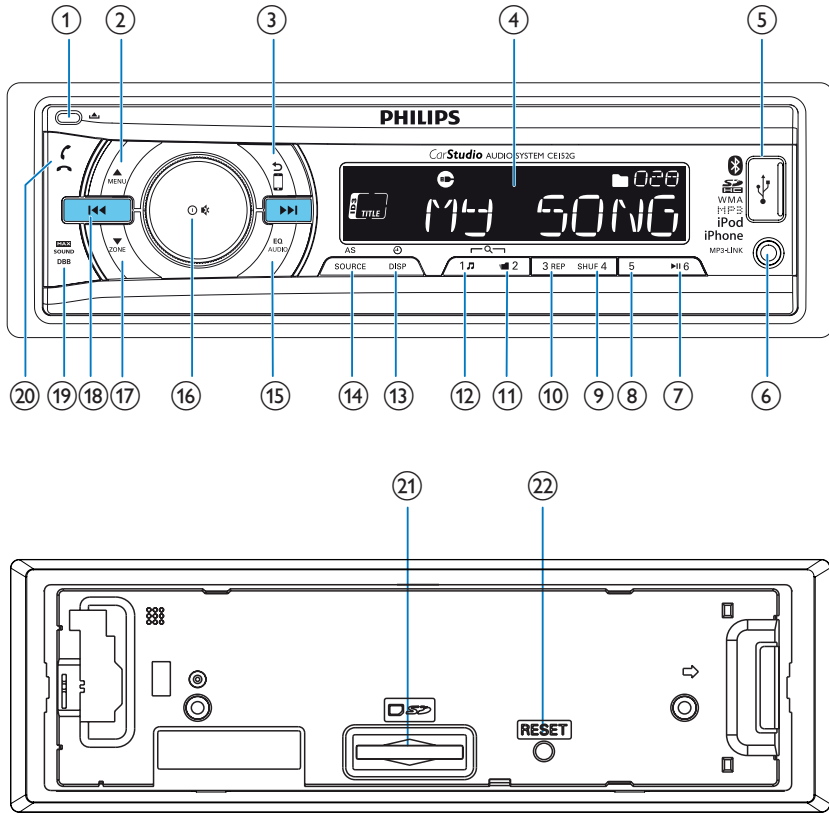

- ①
  - Unlock the front panel.
- ② MENU
  - For .wma and .mp3 tracks on a storage device, press to select the previous folder.
  - Press and hold to access the system menu.
  - Press to select a tuner band.
- ③
  - Return to the previous menu.
- ④ LCD screen
  - For iPod/iPhone, press repeatedly to select a control mode: control play on the iPod/iPhone or on this system.
  - During a call, press and hold to transfer the phone call to mobile phone.
- ⑤
  - Connect to a USB storage device.
  - Connect to a compatible iPod/iPhone.
- ⑥ MP3-LINK
  - Connect to the audio output socket (usually the headphone socket) of an external device.

⑦  6

- Start, pause, or resume the play of tracks.
- In radio mode, press to select the preset radio station of No. 6.
- In radio mode, press and hold to store the current radio station at channel No. 6.

## ⑧ 5

- In radio mode, press to select the preset radio station of No. 5.
- In radio mode, press and hold to store the current radio station at channel No. 5.

## ⑨ SHUF 4

- In radio mode, press to select the preset radio station of No. 4.
- In radio mode, press and hold to store the current radio station at channel No. 4.
- For .wma and .mp3 tracks, press repeatedly to select a play mode: play all tracks randomly ([SHU ALL]), play tracks in the current folder or album randomly ([SHU FLD]/[SHU ALBM]), or play all tracks in sequence ([SHU OFF]).

## ⑩ 3 REP

- In radio mode, press to select the preset radio station of No. 3.
- In radio mode, press and hold to store the current radio station at channel No. 3.
- For .wma and .mp3 tracks, press repeatedly to select a repeat mode.

⑪  2

- In radio mode, press to select the preset radio station of No. 2.
- In radio mode, press and hold to store the current radio station at channel No. 2.
- For .wma and .mp3 tracks on a storage device, press to access the folder list.

⑫ 1 

- In radio mode, press to select the preset radio station of No. 1.
- In radio mode, press and hold to store the current radio station at channel No. 1.
- For .wma and .mp3 tracks on a storage device, press to access the track list.
- Press to access the music menu of an iPod/iPhone.

⑬  /DSP

- Press repeatedly to display available information about the current track.
- Press repeatedly to display available RDS information.
- Press and hold to display the set clock.

## ⑭ AS/SOURCE

- Press repeatedly to select a source.
- In radio mode, press and hold to activate the automatic search of radio stations.

⑮  AUDIO

- Press repeatedly to select a preset sound equalizer.
- Press and hold to activate the setup of bass, treble, balance, and fader.

⑯ 

- Press to turn on the system.
- Press and hold to turn off the system.
- Press to mute or restore sound.
- Press to confirm an option.
- Rotate to switch between menu options.
- Rotate to adjust the volume level.

⑰  ZONE

- For .wma and .mp3 tracks on a storage device, press to select the next folder.
- Press and hold to activate the selection of listening zones.
- Press to select a tuner band.

18

- Tune to a radio station.
- Press to skip to the previous/next track.
- Press and hold to rewind a track or search fast forward.

19

- Press to enable or disable the **MAX Sound** feature.
- Press and hold to enable or disable the DBB (dynamic bass boost) sound effect.

20

- Press to answer or redial a call.
- Press to hang up a call.
- Press and hold to reject an incoming call.

21

- Insert an SD/SDHC card.

22 **RESET**

- Press to reboot the system.

## 3 Install the car audio system



### Caution

- Use the controls only as stated in this user manual.

Always follow the instructions in this chapter in sequence.

These instructions are for a typical installation. However, if your car has different requirements, make the adjustment accordingly. If you have any question regarding installation kits, consult your local retailer.



### Note

- This system is designed for negative ground (earth) 12V DC operation only.
- Always install this system in the car dashboard. Other locations can be dangerous as the rear of the system heats up during use.
- To avoid short-circuit: before you connect, make sure that the ignition is off.
- Make sure that you connect the yellow and red power supply leads after all other leads are connected.
- Make sure that all loose leads are insulated with electrical tape.
- Make sure that the leads do not get caught under screws iron parts that will move (e.g. seat rail).
- Make sure that all ground (earth) leads are run to a common ground (earth) point.
- Use only the supplied mounting hardware for a safe and secure installation.
- Improper fuses can cause damage or fire. When you need to change the fuse, consult a professional.
- When you connect other devices to this system, make sure that the rating of the car circuit is higher than the total fuse value of all the connected devices.
- Never connect speaker wires to the metal body or chassis of the car.
- Never connect speaker wires with stripes to one another.

# Connect wires



## Note

- Make sure that all loose leads are insulated with electrical tape.
- Consult a professional to connect wires as instructed below.

- 1** Check the car's wiring carefully and connect them to the supplied ISO male connectors.

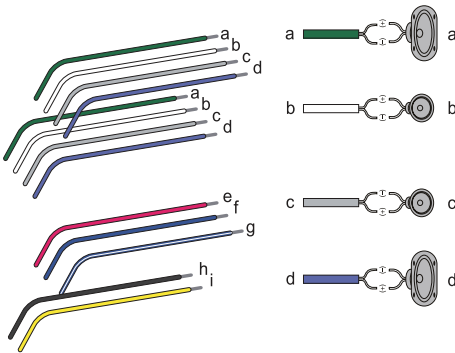

ISO male connectors	Connect to
a	Green strip, black-edged green strip Rear left speaker
b	White strip, black-edged white strip Front left speaker
c	Gray strip, black-edged gray strip Front right speaker
d	Purple strip, black-edged purple strip Rear right speaker
e	Red strip Ignition key +12V DC when ON/ACC
f	Blue strip Motor/electric antenna relay control lead
g	White-edged blue strip Amplifier relay control lead
h	Black strip Ground

i Yellow strip To the +12V car battery which is energized at all times

- 2** Connect other wires if necessary.

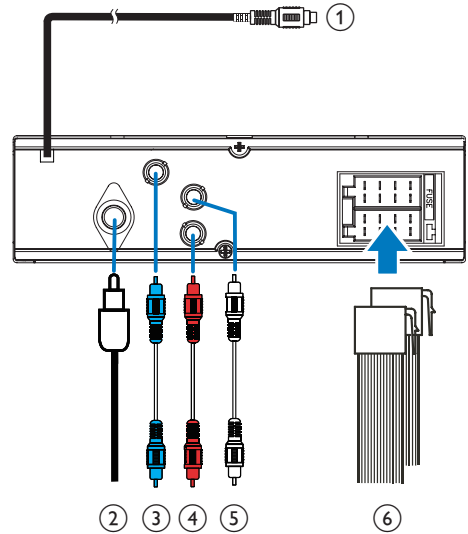

Sockets or connectors on rear panel	External sockets or connectors
1 <b>External Mic</b>	An external microphone for phone calls
2 <b>FM/MW radio antenna socket</b>	FM/MW radio antenna
3 <b>SUB-W OUT</b>	A sub-woofer
4 <b>REAR R</b>	Rear right speaker
5 <b>REAR L</b>	Rear left speaker
6 <b>For ISO male connectors</b>	ISO male connectors



## Tip

- The pin arrangement for the ISO connectors depends on the type of your vehicle. To avoid damage to the unit, connect properly.



## Mount into the dashboard

- If the car does not have an on-board drive or navigation computer, disconnect the negative terminal of the car battery.
  - If the car battery is not disconnected, to avoid short-circuit, make sure that the bare wires do not touch each other.
- 1** Make sure that the car dashboard opening is within these measurements:

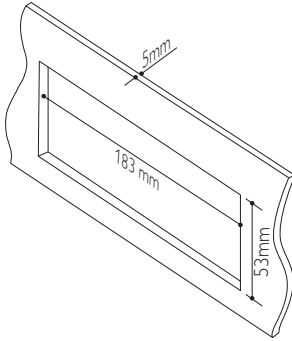

- 2** Remove the mounting sleeve with the supplied disassembly tools.

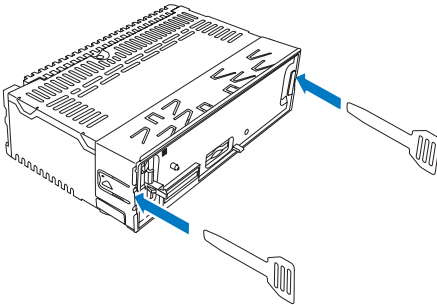

- 3** Install the sleeve into the dashboard and bend the tabs outward to fix the sleeve.

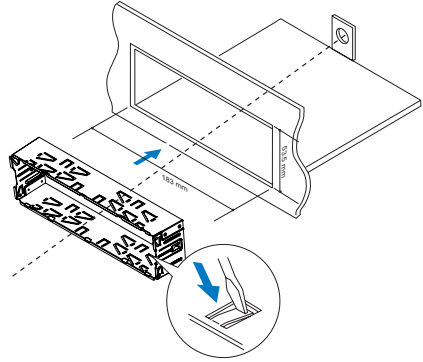

- 4** Slide the unit into the sleeve until you hear a "click".

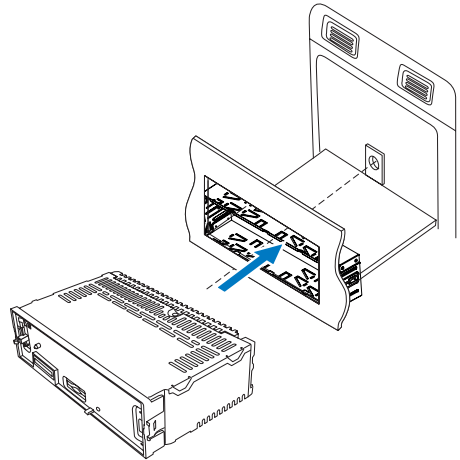

- 5 Attach the trim plate.

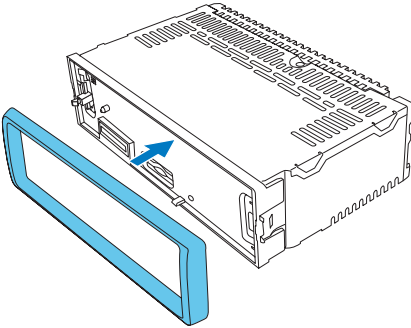

- 6 Reconnect the negative terminal of the car battery.

## Attach the front panel

- 1 Insert the notch on the front panel to the chassis on the main unit.

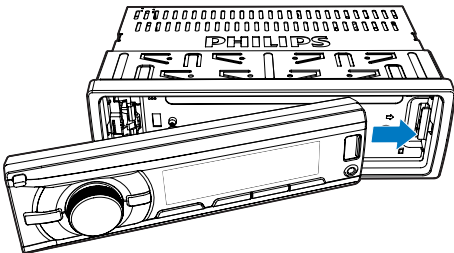

- 2 Press the left end of the front panel inwards until it is securely locked with a "click".

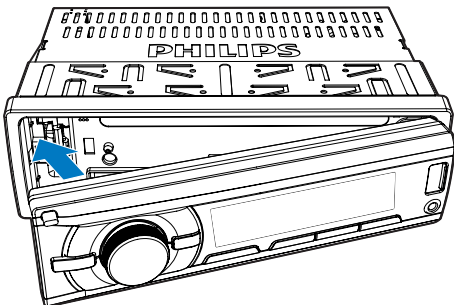

## Detach the front panel

### Note

- Before you insert an SD/SDHC card or reset the system, detach the front panel.
- Before you detach the front panel, make sure that the system is turned off.

- 1 Press  to release the front panel.
- 2 Pull the front panel outwards to remove it.

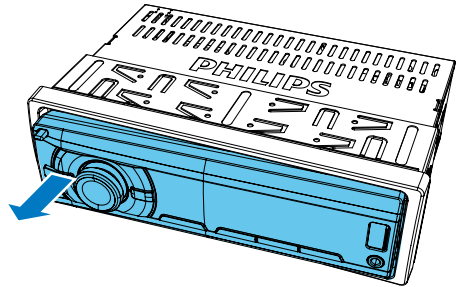

## 4 Get started

---

### For the first time use

- 1 Press **⏻** to turn on the system.  
↳ **[PHILIPS]** is displayed and then **[SELECT OPERATING REGION]** (select a radio region) scrolls.
- 2 When one of the following options is displayed, rotate **⌚** to select a radio region that matches your location.
  - **[AREA EUROPE]** (Western Europe)
  - **[AREA ASIA]** (Asia Pacific)
  - **[AREA MID--EAST]** (Middle East)
  - **[AREA AUST]** (Australia)
  - **[AREA RUSSIA]** (Russia)
  - **[AREA USA]** (United States)
  - **[AREA LATIN]** (Latin America)
  - **[AREA JAPAN]** (Japan)
- 3 Press **⏻** to confirm.  
↳ The system switches to radio mode automatically.
  - To turn off the system, press and hold **⏻** until the screen backlight is off.

---

### Set the time format

- 1 Press and hold **▲** to access the system menu.
- 2 Press **▲** / **▼** repeatedly until **[CLK 24H]** or **[CLK 12H]** is displayed.
- 3 Rotate **⌚** to select **[CLK 24H]** or **[CLK 12H]**.
  - **[CLK 24H]**: 24-hour time format
  - **[CLK 12H]**: 12-hour time format

---

### Set the clock

- 1 Press and hold **▲** to access the system menu.
- 2 Press **▲** / **▼** repeatedly until **[CLK]** is displayed with time digits blinking.
- 3 Rotate **⌚** anti-clockwise to set the hour.
- 4 Rotate **⌚** clockwise to set the minute.

---

### Display the clock

Press and hold **⌚** / **DISP** until **[CLK]** and the set clock are displayed.

- To exit the clock display, press any button or rotate **⌚**.



---

### Select a source

Press **AS/SOURCE** repeatedly to select a source.





- **[RADIO]**: Listen to FM/AM radio.
- **[MP3--LINK]**: Listen to the audio input through the **MP3-LINK** socket.
- **[iPod/USB]**: When a USB storage device or compatible iPod/iPhone is connected and recognized, you can select this source to play audio files that are stored on it.
- **[SD/SDHC]**: When an SD/SDHC card is inserted and recognized, you can select this source to play audio files that are stored on it.
- **[BT AUDIO]**: When a Bluetooth player is connected, you can select this source to transfer audio from the player to this system via Bluetooth.

## Select a listening zone

- 1 Press and hold  until one of the following options is displayed.
  - **[ALL]**: For all passengers
  - **[FRONT-L]**: For the front-left seat only
  - **[FRONT-R]**: For the front-right seat only
  - **[FRONT]**: For front passengers only
- 2 Press  /  repeatedly to select a listening zone.

## Mute the button beep

The beep sound of buttons is enabled by default.

- 1 Press and hold  to access the system menu.
- 2 Press  /  repeatedly until **[BEEP ON]** or **[BEEP OFF]** is displayed.
  - **[BEEP ON]**: Enable the beep sound of buttons.
  - **[BEEP OFF]**: Mute the beep sound of buttons.
- 3 Rotate  to change the setting.

# 5 Listen to radio

## Switch to radio mode

- 1 Press **AS/SOURCE** repeatedly to switch the source to **[RADIO]**.
- 2 Press  /  repeatedly to select a band.





## Select a tuner region

You can select a radio region that matches your location.

- 1 Press and hold  to access the system menu.
- 2 Press  /  repeatedly until one of the following options is displayed.
  - **[AREA EUROPE]** (Western Europe)
  - **[AREA ASIA]** (Asia Pacific)
  - **[AREA MID--EAST]** (Middle East)
  - **[AREA AUST]** (Australia)
  - **[AREA RUSSIA]** (Russia)
  - **[AREA USA]** (United States)
  - **[AREA LATIN]** (Latin America)
  - **[AREA JAPAN]** (Japan)
- 3 Rotate  to select a region.

## Select a tuner sensitivity

To search for radio stations with strong signals only or more radio stations, you can change the tuner sensitivity.

- 1 Press and hold  to access the system menu.
- 2 Press  /  repeatedly until **[LOC ON]** or **[LOC OFF]** is displayed.
- 3 Rotate  to select a setting.
  - **[LOC ON]**: Search for radio stations with strong signals only.
  - **[LOC OFF]**: Search for radio stations with strong and weak signals.

---

## Search for a radio station

---

### Search for a radio station automatically

Press **◀◀** or **▶▶** to search for the previous or next radio station with strong signals.

---

### Search for a radio station manually

- 1 Press and hold **◀◀** or **▶▶** until **[M]** blinks.
- 2 Press **◀◀** or **▶▶** repeatedly until the target frequency is displayed.

---

## Store radio stations in memory

### Note

- You can store a maximum of six stations in each band.

---

### Store radio stations automatically

- 1 Press **▲** **MENU** or **▼** **ZONE** repeatedly to select a band.
- 2 Press and hold **AS/SOURCE** until **[STORE---**] is displayed.
  - ↳ After the search is complete, the first stored radio station is broadcast automatically.
  - To select a stored radio station, press **1** **♪**, **2** **3** **REP**, **SHUF** **4**, **5**, or **▶** **6**.

---

### Store radio stations manually

- 1 Press **▲** **MENU** or **▼** **ZONE** repeatedly to select a tuner band.
- 2 Tune to the radio station that you want to store.

- 3 Press and hold **1** **♪**, **2** **3** **REP**, **SHUF** **4**, **5**, or **▶** **6** to store the radio station at the selected channel.

- To select a stored radio station, press **1** **♪**, **2** **3** **REP**, **SHUF** **4**, **5**, or **▶** **6**.

---

## Play with RDS

The RDS (Radio Data System) function operates only in areas with FM stations broadcasting RDS signals. If you tune to an RDS station, the station name is displayed.

---

### Enable the RDS function

#### Note

- The RDS function is enabled by default.
- Only when the RDS function is enabled, RDS related settings can be accessed.

- 1 Press and hold **▲** **MENU** to access the system menu.
- 2 Press **▲** **MENU** / **▼** **ZONE** repeatedly until **[RDS ON]** or **[RDS OFF]** is displayed.
- 3 Rotate **⌚** **⌘** to select **[RDS ON]**.
  - ↳ The RDS function is enabled.
  - To disable the RDS function, rotate **⌚** **⌘** to select **[RDS OFF]**.

---

### Select a program type





Before tuning to RDS stations, you can select a program type to search for programs of the selected category only.

- 1 Press and hold **▲** **MENU** to access the system menu.
- 2 Press **▲** **MENU** / **▼** **ZONE** repeatedly until **[PTY]** is displayed.
- 3 Press **⌚** **⌘** to access the list of program types.
- 4 Rotate **⌚** **⌘** to select a program type, and then press **⌚** **⌘** to confirm.

Item	Program type	Description
1	NEWS	News services
2	AFFAIRS	Politics and current affairs
3	INFO	Special information programs
4	SPORT	Sports
5	EDUCATE	Education and advanced training
6	DRAMA	Radio plays and literature
7	CULTURE	Culture, religion and society
8	SCIENCE	Science
9	VARIED	Entertainment programs
10	POP M	Pop music
11	ROCK M	Rock music
12	EASY M	Light music
13	LIGHT M	Light classical music
14	CLASSICS	Classical music
15	OTHER M	Special music programs
16	WEATHER	Weather
17	FINANCE	Finance
18	CHILDREN	Children's programs
19	SOCIAL	Social Affairs
20	RELIGION	Religion
21	PHONE IN	Phone In
22	TRAVEL	Travel
23	LEISURE	Leisure
24	JAZZ	Jazz Music
25	COUNTRY	Country Music
26	NATION M	National Music
27	OLDIES	Oldies Music
28	FOLK M	Folk Music
29	DOCUMENT	Documentary
30	TEST	Alarm Test
31	ALARM	Alarm





## Use alternate frequencies

If the signal of an RDS station is poor, enable the AF (Alternate Frequency) function to search for another station that broadcasts the same program.

- 1 Press and hold  to access the system menu.
- 2 Press  /  repeatedly until [AF ON] or [AF OFF] is displayed.
- 3 Rotate  to select a setting.
  - [AF ON]: Enable the AF function.
  - [AF OFF]: Disable the AF function.





## Set the region for AF tuning

You can set the region for AF tuning.

- 1 Press and hold  to access the system menu.
- 2 Press  /  repeatedly until [REG ON] or [REG OFF] is displayed.
- 3 Rotate  to select a setting.
  - [REG ON]: Only RDS stations in current region can be tuned to automatically.
  - [REG OFF]: All RDS stations can be tuned to automatically.

## Receive traffic announcement

If you want to receive traffic announcement, enable the TA (Traffic Announcement) function.





- 1 Press and hold  to access the system menu.
- 2 Press  /  repeatedly until [TA ON] or [TA OFF] is displayed.
- 3 Rotate  to select a setting.
  - [TA ON]: When a traffic announcement is on air, the system automatically switches to the tuner mode and begins to broadcast the traffic announcement. When the traffic announcement is over, the system returns to the previous mode.
  - [TA OFF]: Traffic announcement does not cut in.

## Tip

- When a traffic announcement cuts in, you can press  to switch the system to the previous mode.

## Synchronize the system clock

You can synchronize the system clock with an RDS station that transmits time signals.

- 1 Press and hold  to access the system menu.
- 2 Press  /  repeatedly until [CT ON] or [CT OFF] is displayed.
- 3 Rotate  to select a setting.
  - [CT ON]: Synchronize the system clock with the RDS station automatically.
  - [CT OFF]: The automatic clock synchronization with RDS station is disabled.

## Tip

- The accuracy of time depends on the RDS station that transmits time signals.

# 6 Play from a storage device



This system can play .mp3 and .wma files that are copied onto a compatible storage device.

## Note

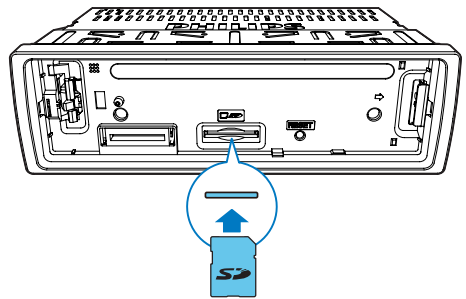
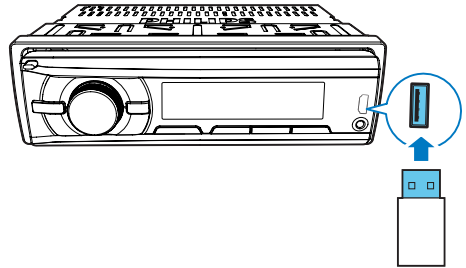



- Philips does not guarantee compatibility with all storage devices.
- NTFS (New Technology File System) file system is not supported.



- 1 Connect a compatible USB storage device or SD/SDHC card.
  - For an SD/SDHC card, detach the front panel first, insert the card into the  slot, and then attach the front panel.

- 2 Press **AS/SOURCE** repeatedly to switch the source.
  - **[iPod/USB]**: For a USB storage device that is connected to the USB socket on the front panel
  - **[SD/SDHC]**: For an SD/SDHC card that is inserted into the  slot
- 3 If the play does not start, press  **6**.



## Control play

Button	Function
 MENU / ZONE	Press repeatedly to select a folder.
 <b>6</b>	Pause or resume play.
	Press to play the previous or next track.
	Press and hold to rewind a track or search forward fast.
 /DISP	Press repeatedly to display available information about the current track.
<b>3</b> REP	Press repeatedly to select a repeat mode: <ul style="list-style-type: none"> <li>• <b>[REP ONE]</b>: repeat the current track,</li> <li>• <b>[RPT FLD]</b>: repeat all tracks in the current folder, or</li> <li>• <b>[RPT ALL]</b>: repeat all tracks in the storage device.</li> </ul>
SHUF <b>4</b>	Press repeatedly to select a play mode: <ul style="list-style-type: none"> <li>• <b>[SHU ALL]</b>: play all tracks randomly,</li> <li>• <b>[SHU FLD]</b>: play tracks in the current folder randomly, or</li> <li>• <b>[SHU OFF]</b>: play all tracks in the storage device in sequence.</li> </ul>



## Switch tracks

During play, you can switch tracks or folders quickly.

### Switch tracks directly

- 1 Press  to access the track list.
  - ↳ The file name of current track scrolls.
- 2 Rotate  to toggle through tracks.
- 3 Press  to play the selected track.

### Switch folders for a track

- 1 Press  **2** to access the folder list.
  - ↳ The name of current folder scrolls.
- 2 Rotate  to toggle through folders.
- 3 Press  to select the folder.
  - ↳ The system starts playing the first track under the folder.



# 7 Play from an iPod/iPhone

## Note

- During play, no audio signals are transferred through the headphone socket of your iPod/iPhone.

## Compatible iPod/iPhone models

This car audio system supports the following iPod and iPhone models.

- iPhone 4S, iPhone 4, iPhone 3GS, and iPhone 3G
- iPod touch (2nd, 3rd, and 4th generations)
- iPod classic
- iPod nano (3rd, 4th, 5th, and 6th generations)

## Connect your iPod/iPhone

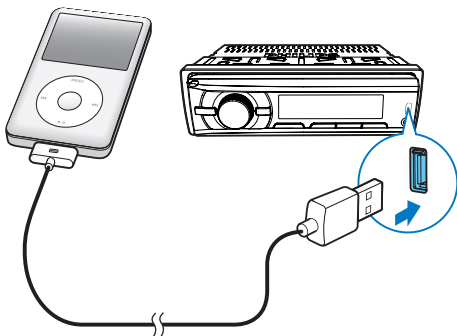

- 1 Connect an Apple 30-pin USB cable between
  - the USB socket on the front panel, and
  - your iPod/iPhone.

- 2 Press **AS/SOURCE** repeatedly to switch the source to **[iPod/USB]**.
  - ↳ The system starts playing tracks that are stored on your iPod/iPhone.

## Note









- Before you disconnect the iPod/iPhone, switch the system to another source.

## Control play

Button	Function
	Press repeatedly to select a control mode: control play on your iPod/iPhone, or on the system.
	Press to pause or resume play.
	Press to play the previous or next track.
	Press and hold to rewind a track or search forward fast.
 /DISP	Press repeatedly to display available information about the current track.
 REP	Press repeatedly to select a repeat mode: <ul style="list-style-type: none"><li>• <b>[REP ONE]</b>: repeat the current track, or</li><li>• <b>[REP ALL]</b>: repeat all tracks.</li></ul>
 4	Press repeatedly to select a play mode: <ul style="list-style-type: none"><li>• <b>[SHU ALL]</b>: play all tracks randomly,</li><li>• <b>[SHU ALBM]</b>: play tracks in the current album randomly, or</li><li>• <b>[SHU OFF]</b>: play all tracks in the iPod/iPhone library in sequence.</li></ul>

## Search for a track

After accessing the iPod/iPhone menu, you can select a specific track quickly.

- 1 Press **1**  to access the iPod/iPhone menu.  
↳ **[PLAYLIST]** scrolls.
- 2 Rotate   to select a category.
- 3 Press   to access the list of tracks under the category.  
↳ The file name of the first track scrolls.
- 4 Rotate   to select a track.  
↳ The file name of current track scrolls.
- 5 Press   to start play.

## Charge your iPod/iPhone

Once the iPod/iPhone is docked and recognized, the charging starts.

# 8 Use Bluetooth devices

With this car audio system, you can listen to audio from a player or make a call through Bluetooth.

## Connect a device



### Note

- Philips does not guarantee the compatibility with all Bluetooth devices.
- Before pairing a device with this system, read its user manual for Bluetooth compatibility.
- Make sure that Bluetooth function is enabled on your device, and your device is set as visible to all other Bluetooth devices.
- At one time, you can connect only one Bluetooth device to this system.
- The operational range between this system and a Bluetooth device is approximately 3 meters (9 feet).
- Any obstacle between this system and a Bluetooth device can reduce the operational range.
- Keep away from any other electronic device that may cause interference.

On your device, follow the steps below.

- 1 Search for Bluetooth devices.
- 2 In the device list, select **CE152**.
- 3 Enter the default password "**0000**", and then confirm the password entry.  
↳ If the pairing succeeds, **[PAIRED]** is displayed on the LCD screen of this system.
- 4 Enable or permit the connection with CE152.  
↳ If the connection succeeds, **[CONNECTED]** scrolls and  is displayed on the LCD screen of this system.  
↳ If the connection fails, **[FAILED]** is displayed on the LCD screen of this system.

---

## Disconnect a device

- 1 Press and hold to access the system menu.
- 2 Press / repeatedly until [DIS--CON] is displayed.
- 3 Press .
  - ↳ [WAIT] is displayed with -, --, and --- blinking alternately until [DISCONNECTED] scrolls.



Tip

- You can also complete the disconnection on your device.

---

## Reconnect a device

Some Bluetooth devices support the automatic reconnection with a paired Bluetooth device. If your device does not support automatic reconnection, reconnect it with this system manually.

- 1 Press and hold to access the system menu.
- 2 Press / repeatedly until [RE--CON] is displayed.
- 3 Press .
  - ↳ [WAIT] is displayed with -, --, and --- blinking alternately until [CONNECTED] scrolls or [FAILED] appears.
  - ↳ If [CONNECTED] scrolls, this system is reconnected to the last connected device.



Tip

- You can also complete the reconnection on your device.

---

## Play audio from a Bluetooth device

If the connected Bluetooth device supports Advanced Audio Distribution Profile (A2DP), you can listen to tracks that are stored on the device through the system. If the device also supports Audio Video Remote Control Profile (AVRCP) profile, you can control play on the system or with its remote control.

- 1 Play a track on the connected device.
- 2 Press **AS/SOURCE** repeatedly to switch the source to [BT AUDIO].
  - ↳ Play starts automatically.
  - To pause or resume play, press 6.
  - To skip to the previous or next track, press / .



Note

- If the connected device does not support the AVRCP profile, control play on the connected device.

---

## Make a call



Note

- Keep the Bluetooth connection active between the system and your mobile phone.

---

## Call a number

On your mobile phone, call a number.

- ↳ [CALLING] is displayed.

---

## Redial the last called number

- 1 Press .
  - ↳ [REDIAL] is displayed.
- 2 Press to confirm.
  - ↳ [CALLING] is displayed.

## Pick up an incoming call

When the system receives an incoming call, the phone number or **[PHONE IN]** is displayed. Press **⏏** to answer the call.

## Reject an incoming call

Press and hold **⏏** until **[END]** is displayed.

## End a call

To end an on-going call, press **⏏**.

## Transfer a call to mobile phone

By default, the voice comes from the loudspeakers during a call.

- 1 Press and hold **☎** until **[TRANSFER]** is displayed.
  - ↳ The loudspeakers are muted, and the voice comes from your mobile phone only.
- 2 Take up your mobile phone for the conversation.

# 9 Listen to an external player

You can use the system to amplify the audio input from an external player; for example, MP3 player.

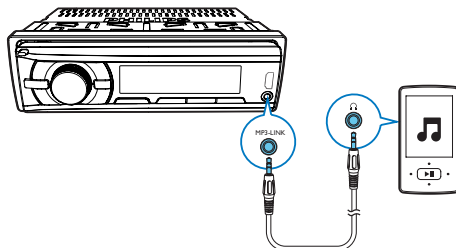

- 1 Press **AS/SOURCE** repeatedly to switch the source to **[MP3--LINK]**.
- 2 Connect an audio input cable with a 3.5 mm connector on both ends between
  - the **MP3-LINK** socket on the front panel, and
  - the audio output socket (usually the headphone socket) on the external player.
- 3 Play audio on the external player.

## 10 Adjust sound

The following operations are applicable to all supported media.

Button	Function
① 🔊	Rotate to increase or decrease the volume level.
① 🔊	Press to mute the speakers or release them from mute status.
MAX SOUND DBB	Press to enable or disable the <b>MAX Sound</b> feature.
MAX SOUND DBB	Press and hold to enable or disable the Dynamic Bass Boost (DBB) effect.
EQ AUDIO	Press repeatedly to select a sound equalizer.
EQ AUDIO	<ol style="list-style-type: none"><li>1 Press and hold to activate the setup of customized sound equalizer.</li><li>2 Press repeatedly to select an option: <b>[BAS]</b> (bass), <b>[TRE]</b> (treble), <b>[BAL]</b> (balance), <b>[FAD]</b> (fader), or <b>[SUBW]</b> (sub-woofer).</li><li>3 Rotate ① 🔊 to adjust the setting.</li></ol>

## 11 Additional information

### Reset the system

If the system works abnormally, reset the system to factory default settings.

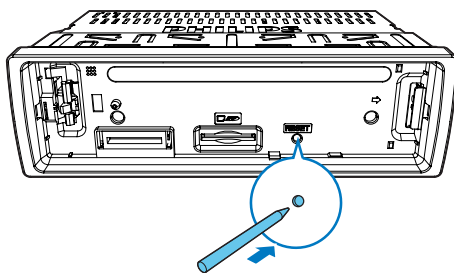

- 1 Detach the front panel.
- 2 Press the **RESET** button with the tip of a ball-point pen or toothpick.  
↳ All settings are reset to factory default.

### Replace the fuse

If there is no power, check the fuse and replace it if it is damaged.

- 1 Check the electric connection.
- 2 Remove the damaged fuse from the rear panel.

- 3 Insert a new fuse with the same specifications (15 A).

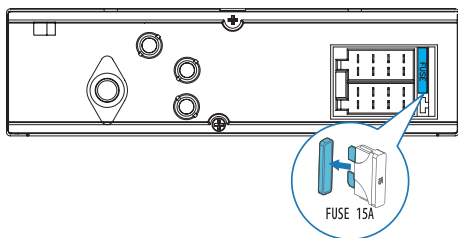

#### Note

- If the fuse gets damaged immediately after it is replaced, an internal malfunction may occur. In such case, consult your Philips retailer.

## 12 Product information

#### Note

- Specifications are subject to change without prior notice.

#### General

Power supply	12V DC (11V - 16 V), negative ground
Fuse	15 A
Suitable speaker impedance	4 - 8 $\Omega$
Maximum power output	50 W $\times$ 4 channels
Continuous power output	22 W $\times$ 4 RMS (4 $\Omega$ 10% T.H.D.)
Pre-Amp output voltage	2.0V
Aux-in level	500 mV

#### Radio

Frequency range - FM	87.5 - 108.0 MHz, 65.0 - 74.0 MHz (100kHz per step in auto search and 50kHz per step in manual search)
Usable sensitivity - FM (S/N = 20 dB)	8 $\mu$ V
Frequency range - AM(MW)	522 - 1620 KHz (9 kHz) 530 - 1710 kHz (10 kHz)
Usable sensitivity - AM(MW) (S/N = 20 dB)	30 $\mu$ V

## Bluetooth

Output power	Class 2
Frequency band	2.4000 GHz - 2.4835 GHz ISM Band
Range	3 meters(free space)
Standard	Bluetooth 2.0 specification

# 13 Troubleshooting



### Warning

- Never remove the casing of this product.

To keep the warranty valid, never try to repair the product yourself.

If you encounter problems when using this product, check the following points before requesting service. If the problem remains unsolved, go to the Philips Web page ([www.philips.com/support](http://www.philips.com/support)). When you contact Philips, make sure that the product is nearby and the model number and serial number are available.

---

## General

### No power or no sound

- The power supply from car battery is cut off, or the car battery runs out of energy. Power the system with car battery.
- Car engine is not on. Turn the car engine on.
- Cable is not correctly connected. Check connections.
- The fuse is burnt. Replace the fuse.
- Volume is too low. Adjust volume.
- If the above solutions do not work, press the **RESET** button.
- Make sure that the current track is in a compatible format.

### Noise in broadcasts

- Signals are too weak. Select other stations with stronger signals.
- Check the connection of the car antenna.

### Preset stations are erased.

- Battery cable is not correctly connected. Connect the battery cable to the terminal that is always live.

**Cannot switch the source to iPod/iPhone**

- Check whether the iPod/iPhone is securely connected.
- Check whether the iPod/iPhone is compatible with this system.
- Check whether the iPod/iPhone battery is nearly empty. Connect it to this system for charging first.

**Display shows ERR-12.**

- Data error. Check the USB storage device or SD/SDHC card.

---

## About the Bluetooth device

**Music playback is unavailable on the system even after successful Bluetooth connection.**

- The device cannot be used with the system to play music.

**The audio quality is poor after connection with a Bluetooth-enabled device.**

- The Bluetooth reception is poor. Move the device closer to the system or remove any obstacle between the device and the system.

**Cannot connect with the system.**

- The device does not support the profiles required for the system.
- The Bluetooth function of the device is not enabled. Refer to the user manual of the device to find out how to enable the function.
- The system is not in the pairing mode.
- The system is already connected with another Bluetooth-enabled device. Disconnect that device or all other connected devices and then try again.

**The paired mobile phone connects and disconnects constantly.**

- The Bluetooth reception is poor. Move the mobile phone closer to the system or remove any obstacle between the mobile phone and the system.
- Some mobile phones may connect and disconnect constantly when you make or end calls. This does not indicate any malfunction of the system.
- For some mobile phones, the Bluetooth connection may be deactivated automatically as a power-saving feature. This does not indicate any malfunction of the system.



# 14 Notice

Any changes or modifications made to this device that are not expressly approved by Philips Consumer Lifestyle may void the user's authority to operate the equipment.

---

## Compliance

# CE 1177

This product complies with the radio interference requirements of the European Community.

---

## Care of the environment



Your product is designed and manufactured with high quality materials and components, which can be recycled and reused.



When this crossed-out wheeled bin symbol is attached to a product it means that the product is covered by the European Directive 2002/96/EC. Please inform yourself about the local separate collection system for electrical and electronic products.

Please act according to your local rules and do not dispose of your old products with your normal household waste.

Correct disposal of your old product helps to prevent potential negative consequences for the environment and human health.

## Environmental information

All unnecessary packaging has been omitted. We have tried to make the packaging easy to separate into three materials: cardboard (box), polystyrene foam (buffer) and polyethylene (bags, protective foam sheet.)

Your system consists of materials which can be recycled and reused if disassembled by a specialized company. Please observe the local regulations regarding the disposal of packaging materials, exhausted batteries and old equipment.

---

## Trademark notice

The Bluetooth® word mark and logos are registered trademarks owned by Bluetooth SIG, Inc. and any use of such marks by Philips is under license.



Windows Media and the Windows logo are trademarks, or registered trademarks of Microsoft Corporation in the United States and/or other countries.



"Made for iPod" and "Made for iPhone" mean that an electronic accessory has been designed to connect specifically to iPod or iPhone respectively, and has been certified by the developer to meet Apple performance standards. Apple is not responsible for the operation of this device or its compliance with safety and regulatory standards. Please note that the use of this accessory with iPod or iPhone may affect wireless performance. iPod and iPhone are trademarks of Apple Inc., registered in the U.S. and other countries. Other trademarks and trade names are those of their respective owners.

---

## Copyright

2013 © Koninklijke Philips Electronics N.V.  
Specifications are subject to change without notice. Trademarks are the property of Koninklijke Philips Electronics N.V or their respective owners. Philips reserves the right to change products at any time without being obliged to adjust earlier supplies accordingly.

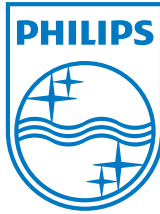

Specifications are subject to change without notice  
© 2013 Koninklijke Philips Electronics N.V.  
All rights reserved.

CE152G\_51\_UM\_V1.0

