

Clock Radio

AJ 3600

Register your product and get support at www.philips.com/welcome

User manual



Clock radio

Meet Philips at the Internet
<http://www.philips.com>

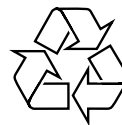

PHILIPS



Printed in China

PDCC-JH-0730

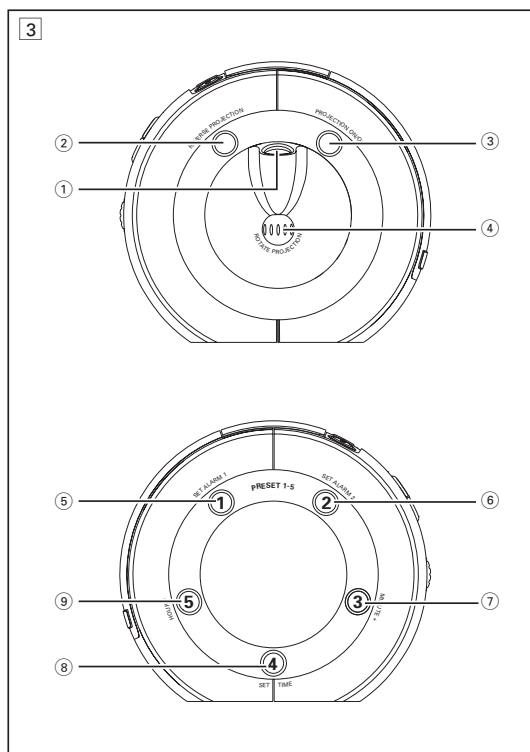
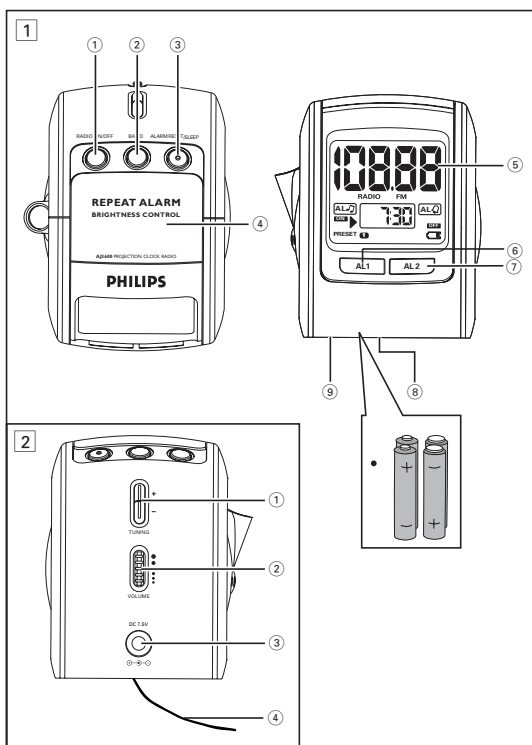

English

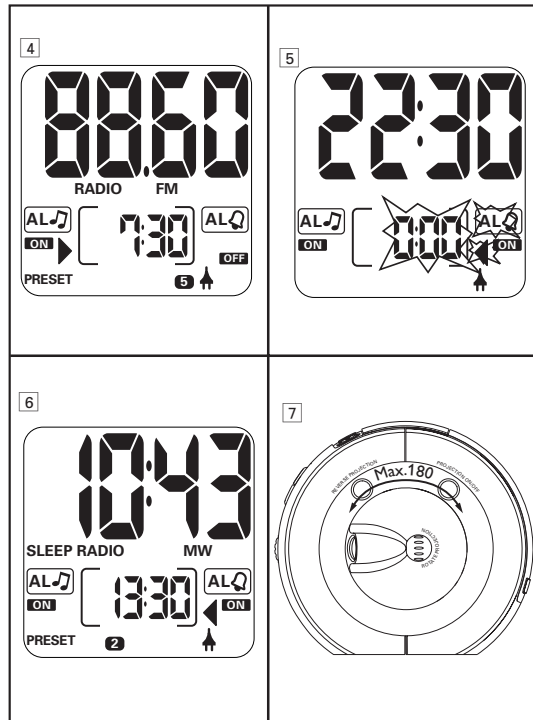

LEFT & RIGHT PANEL (See 3)

- ① **Projection lens**
- ② **REVERSE PROJECTION** – turns time/hour digits upside down (AC-powered only)
- ③ **PROJECTION ON/OFF** – switches the projection on/off
- ④ **ROTATE PROJECTION** – adjusts projection slightly to a different angle
- ⑤ **SET ALARM 1 / PRESET 1** – sets **ALARM 1** time
– stores, recalls and shows station 1
- ⑥ **SET ALARM 2 / PRESET 2** – sets **ALARM 2** time
– stores, recalls and shows station 2
- ⑦ **MINUTE + / PRESET 3** – adjusts the minutes for clock and alarm times
– stores, recalls and shows station 3
- ⑧ **SET TIME / PRESET 4** – sets the clock time
– stores, recalls and shows station 4
- ⑨ **HOUR + / PRESET 5** – adjusts the hours for the clock and alarm times
– stores, recalls and shows station 5

POWER SUPPLY

Batteries (not included)

- 1 Open battery door and insert four batteries (preferably PHILIPS POWER LIFE or alkaline), type R6, UM3 or AA as indicated in the compartment.
 - 2 Remove the batteries from the set if they are exhausted or not be used for a long time.
- When you replace batteries, the preset stations, alarm and clock time settings can be stored for up to 3 minutes. (see 'Self-Powered Back-Up').

Batteries contain chemical substances, so they should be disposed of properly.

Batteries (battery pack or battery installed) shall not be exposed to excessive heat such as sunshine, fire or the like.



Mains adapter

- 1 Connect the mains adapter to the set's **DC 7.5V** socket and to the power socket.
→ ↑ indicates the set is now adapter operated.

SUPPLIED ACCESSORIES

- 1 X certified AC/DC 7.5V adapter (Sunstrong Inter'l Ind. Ltd., Model: VD075025F) (Input: 110-127V/220-240V ~60/50Hz, Output: 7.5V --- 250mA)

TOP AND FRONT PANEL (See 1)

- ① **RADIO ON/OFF**
– switches the radio on/off; displays radio frequency
– switches off sleep timer
- ② **BAND** – select FM/ MW waveband
- ③ **ALARM RESET / SLEEP**
– stops active alarm for 24 hours
– activates the radio for sleep function
– displays/adjusts/switches off sleep timer
- ④ **REPEAT ALARM / BRIGHTNESS CONTROL**
– switches off the alarm for a 9 minute period
– changes the brightness of the display illumination
– stops SLEEP function
- ⑤ **DISPLAY** – shows clock/alarm times and status of the set
- ⑥ **AL 1 (AL **) – switches on/off **ALARM 1** radio mode
– displays **ALARM 1** time
- ⑦ **AL 2 (AL **) – switches on/off **ALARM 2** buzzer mode
– displays **ALARM 2** time
- ⑧ **Battery compartment** – for 4 batteries, type **R6, UM3, AA**
- ⑨ **RESET** – press if the set / display does not react to operation of any button

BACK PANEL (See 2)

- ① **TUNING +/-** – tunes to radio stations
- ② **VOLUME** – adjusts the sound level
- ③ **DC 7.5V**  – socket for AC/DC 7.5V adapter
- ④ **Pigtail** – improves FM reception

- Make sure your adapter is properly connected to save battery energy!
- 2 Always disconnect the mains adapter if you are not using the set.
→ ↑ indicator goes out.

Helpful hints: To avoid damage to the set, use only the adapter supplied!

The type plate is located on the bottom of the set inside the battery compartment.

SELF-POWERED BACK-UP

The self-powered back-up conveniently allows your preset stations, alarm and clock time settings to be stored for **up to 3 minutes** when there is a power interruption e.g. AC power failure or when changing batteries. The complete clock radio and back-light illumination will be switched off.

If power supply returns after 3 minutes and the display shows:

- clock time blinking - indicates you need to re-adjust the clock time.

BATTERY LOW MODE

 indicates batteries low. Replace with fresh batteries to ensure all the features on your set will function properly.

BASIC FEATURES

Reset

Should your set receive external interference e.g. static electricity from carpets, thunderstorms, etc. RESET allows you to clear all previous settings and start up again.

- Use a ballpoint pen to press the RESET hole found on the bottom of the set.

Illumination brightness

Press **REPEAT ALARM / BRIGHTNESS CONTROL** once or more.

- The brightness of the display can be adjusted:

Bright → **Medium** → **Low** → **Bright** (when AC-powered)
Low → **Bright** → **Low** → **Bright** (when battery-powered)

Helpful hints:

- When battery-powered, the display illumination is default low to help save energy. Any other use of the **BRIGHTNESS CONTROL** for a brighter display adjustment will therefore be effectively limited.

SETTING THE CLOCK

The time is displayed using the 24-hour clock.

1. Check the radio is switched off.
2. Press **SET TIME** to enter the clock setting mode.
3. Hold down or press **HOURL +** or **MINUTE +** repeatedly to set and adjust the hours and minutes respectively. Release **HOURL +** or **MINUTE +** when you have reached the correct setting.
4. Press **SET TIME** to confirm.

RADIO

1. Press **RADIO ON/OFF** once to switch on the radio.
 - Display shows the radio frequency of the last selected waveband briefly before returning to the clock time. Your preset station is also shown if you are listening to a preset. (See [4])
2. Press **BAND** if you wish to change waveband.
3. Adjust the sound using **VOLUME**.
4. Press **RADIO ON/OFF** to switch off.

Helpful hints:

- In standby clock time, to view the current radio frequency,
- Press **RADIO ON/OFF** once or more;
- For preset stations, press the respective **PRESET** button (1-5) once or repeatedly.

TUNING TO RADIO STATIONS





Automatic tuning

- Press **TUNING +/-** one second or more to tune to your station.
 - The radio automatically tunes to a station of sufficient reception.

Manual tuning

- Press **TUNING +/-** briefly or repeatedly until you reach the desired frequency.

Helpful hints:

- If you have selected **AL 1** (AL ) , make sure you have properly tuned to a station before turning off the set.
- If you set and activate the same time for both alarms, only the **AL 2** (AL ) will be activate at the set time.
- When both **AL 1** (AL ) and **AL 2** (AL ) are turned on, by default the display shows the alarm time nearest to activation.
- To check the alarm time setting for **AL 1** or **AL 2**, press **AL 1** or **AL 2** button.
- It is not possible to adjust the alarm time during an alarm call or the repeat alarm mode.

SWITCHING OFF THE ALARM

There are three ways of switching off the alarm. Unless you cancel the alarm completely, the **24-hour ALARM RESET** will be automatically selected after 59 minutes from the time your alarm first goes off.



24 HOUR ALARM RESET

If you want the alarm mode to be stopped immediately but also wish to retain the same alarm setting for the following day:



- Press **ALARM RESET / SLEEP**.
 - You will hear a beep tone confirming 24 hour reset activation.

REPEAT ALARM

This repeats your alarm call at 9 minute intervals.

- During the alarm call, press **REPEAT ALARM / BRIGHTNESS CONTROL**.
 - Display shows (AL ) or (AL ) flashing during a repeat alarm.
- Repeat if desired (up to a maximum of 6 times).

CANCELING THE ALARM COMPLETELY

- Press **AL 1** or **AL 2** button once or more until the **OFF** appears under the respective (AL ) or (AL ) icon.

To improve reception:

For **FM**, extend and position the pigtail fully to obtain optimum reception.
For **MW**, the set is provided with a built-in aerial. Direct the aerial by adjusting the position of your clock radio.

STORING AND USING PRESET STATIONS

You can store up to a total of 10 radio stations in the memory, 5 on each waveband.

1. Tune to your desired station (see TUNING TO RADIO STATIONS).
2. To store a preset, hold down briefly on a **PRESET** button 1-5 until you hear a double beep.
 - Display shows the preset number of your station.
3. Repeat steps 1 and 2 to store your other stations.
- You can overwrite a preset station by storing another frequency in its place.
4. Press a **PRESET** button 1-5 to listen to a preset station.



USING THE ALARM

GENERAL

Two different alarm times can be set. This can be useful when you need to be woken up at a different time e.g. during the week and at the weekend:

- **ALARM 1** - radio mode
- **ALARM 2** - buzzer mode. The gentle wake buzzer alarm increases its beep tone frequency within seconds.

SETTING THE ALARM TIME AND MODE (See [5])

1. Check the radio is switched off.
2. Press **AL 1** or **AL 2** to on.
 - Display: **ON** appears under the respective **AL**  or **AL**  icon.
3. Press and hold **SET ALARM 1** or **SET ALARM 2** until alarm time digits flash.
4. Hold down or press **HOURL +** or **MINUTE +** repeatedly to set and adjust the hours and minutes respectively. Release **HOURL +** or **MINUTE +** when you have reached the correct setting.
5. After both the hours and minutes are set, press **SET ALARM 1** or **SET ALARM 2** to confirm the setting.

SLEEP (See [6])

About Sleep

This set has a built-in sleep timer, which enables the radio to be automatically switched off after a set period of time. There are four sleep time options.

Setting and switching off SLEEP

1. Within 1 second, press **ALARM RESET / SLEEP** twice until the display shows **SLEEP and SL : 60**.
 - The radio is automatically switched on and tunes to the last station.
2. To select other sleep time options, press **ALARM RESET / SLEEP** again within 1 second before the display returns to clock time.
 - The display shows in sequence: **SL : 30**, **SL : 15** and **OFF**.
3. To cancel sleep, press either:
 - **RADIO ON/OFF**
 - **REPEAT ALARM / BRIGHTNESS CONTROL**.
 - **ALARM RESET / SLEEP** once or more until **SLEEP** disappears from the display.

USING THE PROJECTION

You may have the experience of looking for a clock in the darkness. With this projection feature, you can conveniently project the clock time onto a surface e.g. walls ceiling (furniture, glasses not recommended).

1. Press **PROJECTION ON/OFF** to switch on.
 - The **Projection lens** lights up red.
2. Turn the **Projection lens wheel** (maximum 180 degree left or right) and also the set, if necessary, to find a suitable projection surface. (See [7])
3. To change the projected time upside down, press **REVERSE PROJECTION**.
4. To change the projection slightly to a different angle, turn the **ROTATE PROJECTION** ball (maximum 60 degree left or right).
5. Press **PROJECTION ON/OFF** to switch off.
 - The **Projection lens** goes out.

Helpful hints:

- When battery-powered, the projection lens lights up briefly to help save energy.
- For a longer projection time, please use the supplied 7.5V AC adapter to operate the set.

MAINTENANCE & SAFETY

- Install the unit near the AC outlet and where the AC power plug can be easily reached.
- Where the MAINS plug or an appliance coupler is used as the disconnect device, the disconnect device shall remain readily operable.
- The apparatus shall not be exposed to dripping or splashing.
- If you do not intend to use set for a long time, remove the batteries.
- Do not expose the set to humidity, rain, sand or excessive heat caused by heating equipment or direct sunlight.
- To clean your set, use a soft damp cloth or chamois leather. Do not use cleaning products, which contain benzene, thinner, etc. as these may harm the housing.

ENVIRONMENTAL INFORMATION

All unnecessary packaging material has been omitted. The packaging can be easily separated into three materials: cardboard, polystyrene and plastic.

Your set consists of materials which can be recycled if disassembled by a specialized company. Please observe the local regulations regarding the disposal of packaging, dead batteries and old equipment.

TROUBLESHOOTING

If a fault occurs, first check the points listed below before taking the set for repair. If you are unable to remedy a problem by following these hints, consult your dealer or service centre.

WARNING: Under no circumstances should you try to repair the set yourself, as this will invalidate the guarantee. Do not open the set as there is a risk of electric shock!

No sound

- Volume not adjusted
- Adjust the volume

No display backlight / display malfunction/ radio and alarm do not function

- Set is in Power Low mode
- Connect AC/DC adapter or insert fresh batteries

Display error / no reaction to any controls

- Electrostatic discharge
- Press the **RESET** hole on the bottom of the set with a ball-pen. Or disconnect set from AC/DC adaptor and batteries for 5 minutes, then re-plug.

Continuous crackling and hiss noise during MW reception

- Interference from other electrical equipment e.g. TVs, computers, fluorescent lamps
- Move the clock radio away from electrical equipment

Intermittent crackling sound during FM reception

- Weak signal
- Extend and position the pigtail aerial

The alarm does not function

- Alarm time/ mode not set
- See **SETTING THE ALARM**
- Volume too low for radio
- Increase the volume
- **AL 1** (AL ) not tuned to a radio station
- Check if the set is tuned to a radio station before you set **AL1** and when you switch off the radio.

Blurry projection

- Distance/ angle between the projection surface too large
- Reduce the distance/ angle.

The typeplate and production number are located inside the battery compartment.