

Register your product and get support at  
[www.philips.com/welcome](http://www.philips.com/welcome)

**User manual**  
**Mode d'emploi**  
**Manual del usuario**  
**Benutzerhandbuch**  
**Gebruiksaanwijzing**  
**Manuale utente**  
**Användarhandbok**  
**Brugervejledning**



# PHILIPS

## Important notes for users in the U.K.

### Mains plug

This apparatus is fitted with an approved 13 Amp plug. To change a fuse in this type of plug proceed as follows:

- 1 Remove fuse cover and fuse.
- 2 Fix new fuse which should be a BS1362 5 Amp, A.S.T.A. or BSI approved type.
- 3 Refit the fuse cover.

If the fitted plug is not suitable for your socket outlets, it should be cut off and an appropriate plug fitted in its place.

If the mains plug contains a fuse, this should have a value of 5 Amp. If a plug without a fuse is used, the fuse at the distribution board should not be greater than 5 Amp.

*Note: The severed plug must be disposed of to avoid a possible shock hazard should it be inserted into a 13 Amp socket elsewhere.*

### How to connect a plug

The wires in the mains lead are coloured with the following code: blue = neutral (N), brown = live (L).

- As these colours may not correspond with the colour markings identifying the terminals in your plug, proceed as follows:
  - Connect the blue wire to the terminal marked N or coloured black.
  - Connect the brown wire to the terminal marked L or coloured red.
  - Do not connect either wire to the earth terminal in the plug, marked E (or  $\perp$ ) or coloured green (or green and yellow).

Before replacing the plug cover, make certain that the cord grip is clamped over the sheath of the lead - not simply over the two wires.

### Copyright in the U.K.

Recording and playback of material may require consent. See Copyright Act 1956 and The Performer's Protection Acts 1958 to 1972.

## Italia

### DICHIARAZIONE DI CONFORMITA'

Si dichiara che l'apparecchio MCD395 Philips risponde alle prescrizioni dell'art. 2 comma 1 del D.M. 28 Agosto 1995 n. 548.

Fatto a Eindhoven

Philips Consumer Electronics  
Philips, Glaslaan 2  
5616 JB Eindhoven, The Netherlands

## Norge

Typeskilt finnes på apparatens underside.

**Observer: Nettbryteren er sekundert innkopleet. Den innebygde nettdelen er derfor ikke frakopleet nettet så lenge apparatet er tilsluttet nettkontakten.**

For å redusere faren for brann eller elektrisk støt, skal apparatet ikke utsettes for regn eller fuktighet.

## CAUTION

**Visible and invisible laser radiation. If the cover is open, do not look at the beam.**

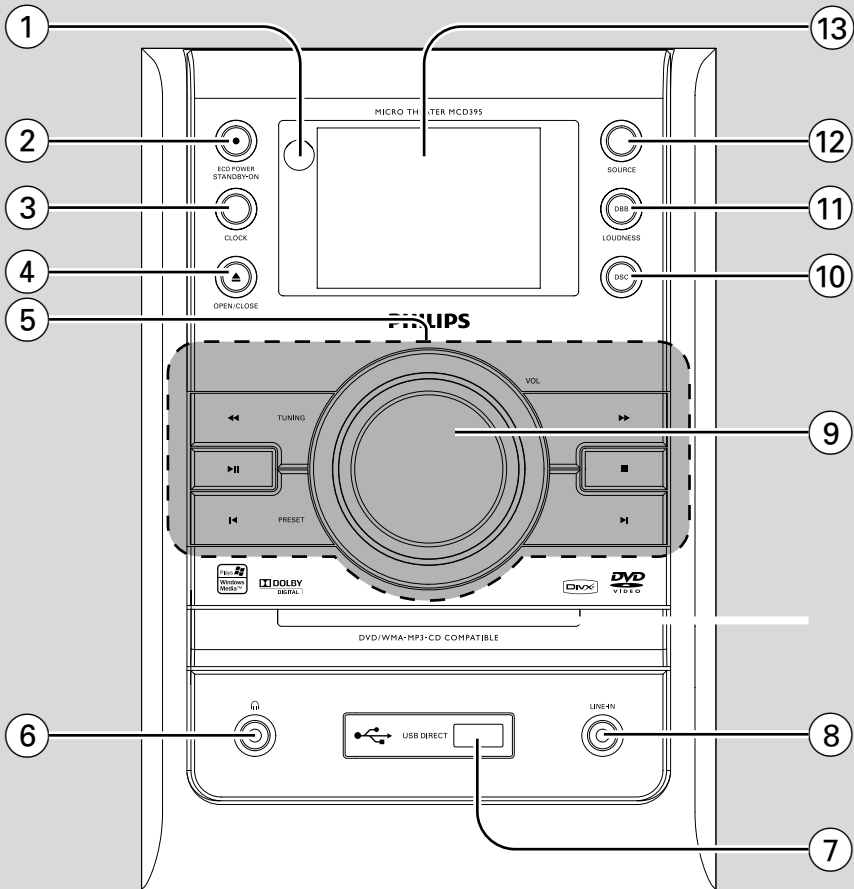

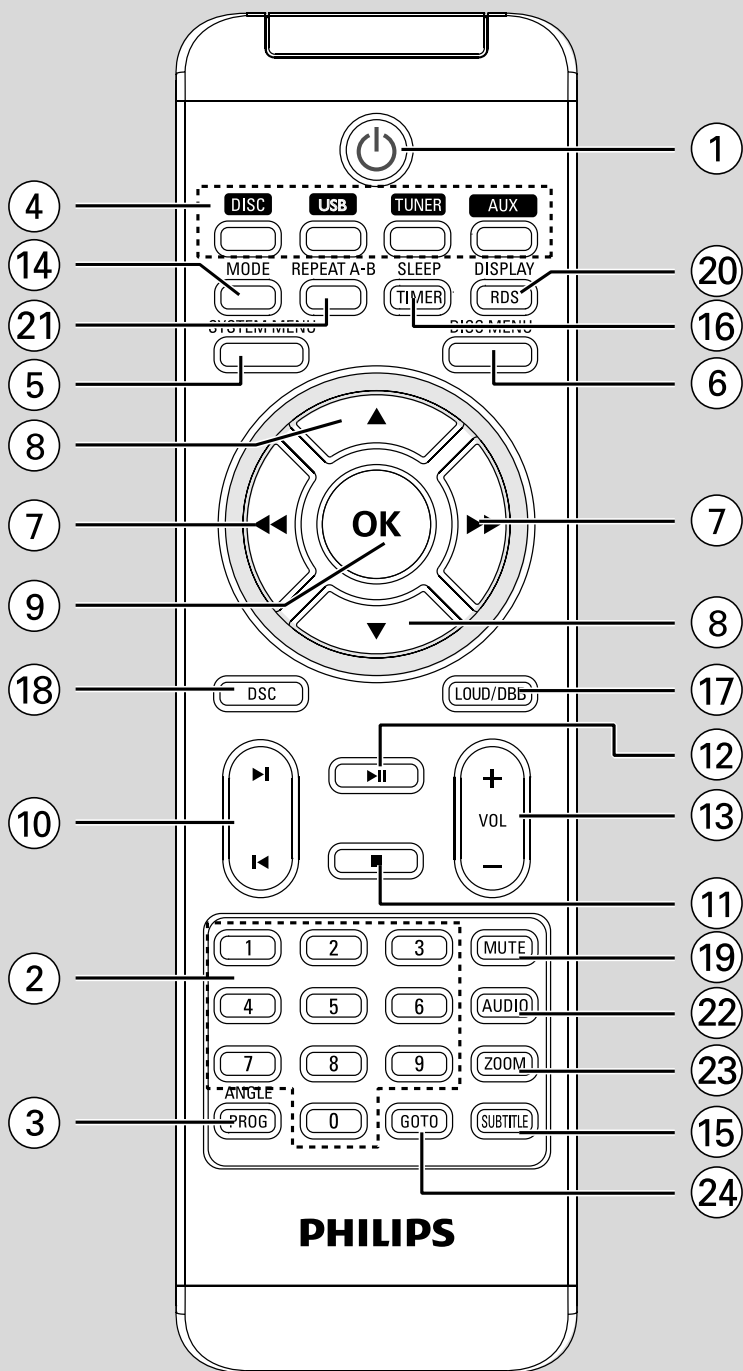

## DK

**Advarsel: Usynlig laserstråling ved åbning når sikkerhedsafbrydere er ude af funktion. Undgå udsættelse for stråling.**

**Bemærk: Netafbryderen er sekundært indkoblet og afbryder ikke strømmen fra nettet. Den indbyggede netdel er derfor tilsluttet til lysnettet så længe netstikket sidder i stikkontakten.**

## S

**Klass 1 laserapparat**

**Varning! Om apparaten används på annat sätt än i denna bruksanvisning specificerats, kan användaren utsättas för osynlig laserstråling, som överskrider gränsen för laserklass 1.**

**Observera! Stömbrytaren är sekundärt kopplad och bryter inte strömmen från nätet. Den inbyggda nåtdelen är därför ansluten till elnätet så länge stickproppen sitter i vägguttaget.**

## SF

**Luokan 1 laserlaite**

**Varoitus! Laitteen käyttäminen muulla kuin tässä käyttöohjeessa mainitulla tavalla saattaa altistaa käyttäjän turvallisuusluokan 1 ylittävälle näkymättömälle lasersäteilylle.**

**Oikeus muutoksiin varataan. Laite ei saa olla alttiina tippu- ja roiskevedelle.**

**Huom. Toiminnanvalitsin on kytketty toisipuolelle, eikä se kytke laitetta irti sähköverkosta. Sisäänrakennettu verkko-osa on kytkettynä sähköverkkoon aina silloin, kun pistoke on pistorasissa.**

## Manufactured under license from Dolby Laboratories.

"Dolby", "Pro Logic" and the double-D symbol are trademarks of Dolby Laboratories.

MANUFACTURED UNDER LICENSE FROM DIGITAL THEATER SYSTEMS, INC. US PAT. NO 5,451,942, 5,956,674, 5,974,380, 5,978,762 AND OTHER WORLDWIDE

PATENTS ISSUED AND PENDING. "DTS" AND "DTS DIGITAL SURROUND" ARE REGISTERED TRADEMARKS OF DIGITAL THEATER SYSTEMS, INC. COPYRIGHT 1996, 2000 DIGITAL THEATER SYSTEMS, INC. ALL RIGHTS RESERVED.

## CAUTION

Use of controls or adjustments or performance of procedures other than herein may result in hazardous radiation exposure or other unsafe operation.

This product incorporates copyright protection technology that is protected by method claims of certain U.S. patents and other intellectual property rights owned by Macrovision Corporation and other rights owners. Use of this copyright protection technology must be authorized by Macrovision Corporation, and is intended for home and other limited viewing uses only unless otherwise authorized by Macrovision Corporation. Reserve engineering or disassembly is prohibited.

**DivX, DivX Certified, and associated logos are trademarks of DivX Networks, Inc and are used under license.**



**Windows Media is a trademark of Microsoft Corporation.**

# Language Code

Abkhazian	6566	Inupiaq	7375	Pushto	8083
Afar	6565	Irish	7165	Russian	8285
Afrikaans	6570	Íslenska	7383	Quechua	8185
Amharic	6577	Italiano	7384	Raeto-Romance	8277
Arabic	6582	Ivrit	7269	Romanian	8279
Armenian	7289	Japanese	7465	Rundi	8278
Assamese	6583	Javanese	7486	Samoan	8377
Avestan	6569	Kalaallisut	7576	Sango	8371
Aymara	6589	Kannada	7578	Sanskrit	8365
Azerbaijani	6590	Kashmiri	7583	Sardinian	8367
Bahasa Melayu	7783	Kazakh	7575	Serbian	8382
Bashkir	6665	Kernewek	7587	Shona	8378
Belarusian	6669	Khmer	7577	Shqip	8381
Bengali	6678	Kinyarwanda	8287	Sindhi	8368
Bihari	6672	Kirghiz	7589	Sinhalese	8373
Bislama	6673	Komi	7586	Slovensky	8373
Bokmål, Norwegian	7866	Korean	7579	Slovenian	8376
Bosanski	6683	Kuanyama; Kwanyama	7574	Somali	8379
Brezhoneg	6682	Kurdish	7585	Sotho; Southern	8384
Bulgarian	6671	Lao	7679	South Ndebele	7882
Burmese	7789	Latina	7665	Sundanese	8385
Castellano, Español	6983	Latvian	7686	Suomi	7073
Catalán	6765	Letzeburgesch;	7666	Swahili	8387
Chamorro	6772	Limbúrgan; Limburger	7673	Swati	8383
Chechen	6769	Lingala	7678	Svenska	8386
Chewa; Chichewa; Nyanja	7889	Lithuanian	7684	Tagalog	8476
中文	9072	Luxembourgish;	7666	Tahitian	8489
Chuang; Zhuang	9065	Macedonian	7775	Tajik	8471
Church Slavíc; Slavonic	6785	Malagasy	7771	Tamil	8465
Chuvash	6786	Magyar	7285	Tatar	8484
Corsican	6779	Malayalam	7776	Telugu	8469
Česky	6783	Maltese	7784	Thai	8472
Dansk	6865	Manx	7186	Tibetan	6679
Deutsch	6869	Maori	7773	Tigrinya	8473
Dzongkha	6890	Marathi	7782	Tonga (Tonga Islands)	8479
English	6978	Marshallese	7772	Tsonga	8483
Esperanto	6979	Moldavian	7779	Tswana	8478
Estonian	6984	Mongolian	7778	Türkçe	8482
Euskara	6985	Nauru	7865	Türkmen	8475
Ελληνικά	6976	Navaho; Navajo	7886	Twí	8487
Faroese	7079	Ndebele, North	7868	Uighur	8571
Français	7082	Ndebele, South	7882	Ukrainian	8575
Frysk	7089	Ndonga	7871	Urdu	8582
Fijian	7074	Nederlands	7876	Uzbek	8590
Gaelic; Scottish Gaelic	7168	Nepali	7869	Vietnamese	8673
Galleghan	7176	Norsk	7879	Volapuk	8679
Georgian	7565	Northern Sami	8369	Walloon	8765
Gikuyu; Kikuyu	7573	North Ndebele	7868	Welsh	6789
Guarani	7178	Norwegian Nynorsk;	7878	Wolof	8779
Gujarati	7185	Occitan; Provençal	7967	Xhosa	8872
Hausa	7265	Old Bulgarian; Old Slavonic	6785	Yiddish	8973
Herero	7290	Oriya	7982	Yoruba	8979
Hindi	7273	Oromo	7977	Zulu	9085
Hiri Motu	7279	Ossetian; Ossetic	7983		
Hrvatski	6779	Pali	8073		
Ido	7379	Panjabi	8065		
Interlingua (International)	7365	Persian	7065		
Interlingue	7365	Polski	8076		
		Português	8084		

English .....	8
Français .....	42
Español .....	76
Deutsch .....	111
Nederlands .....	147
Italiano .....	183
Svenska .....	218
Dansk .....	252

English

Français

Español

Deutsch

Nederlands

Italiano

Svenska

Dansk

# Contents

## General Information

Features .....	10
Discs for playback .....	10
Supplied accessories .....	10
Environmental information .....	11
Care and safety information .....	11

## Connections

Step 1: Placing speakers .....	13
Step 2: Connecting speakers .....	14
Step 3: Antenna connection .....	14
Step 4: Connecting TV .....	14-15
Using Video In jack	
Using S-Video In jack	
Using an accessory RF modulator	
Step 5: Connecting the power cord .....	16
Optional: Connecting additional equipment	16

## Controls

Controls on the system .....	17
Controls on the remote control .....	17-18

## Preparations

Before using the remote control .....	19
Replacing battery .....	19
Step 1: Setting the clock .....	19
Step 2: Setting video preference .....	20-21
Step 3: Setting language preference .....	21

## Basic Functions

Switching the system on .....	22
Switching the system to Eco Power Standby mode .....	22
Power-saving automatic standby .....	22
Sound control .....	22
DBB	
DSC	
LOUDNESS	
Volume control .....	22

## Disc Operations

Playing discs .....	23
Using the disc menu .....	23
Basic playback controls .....	23-25
Pausing playback	
Selecting a track/chapter/title	
Resuming playback from the last stopped point	
Zoom	
Repeat and shuffle modes	
Repeat A-B	
Program	
Forward/Reverse Searching	
Time search & search by chapter/track number	
Information display during playback	
Special disc features .....	25
Playing a Title	
Camera Angle	
Changing the Audio Language	
Changing the Audio Channel	
Subtitles	
Playing MP3 disc .....	26
General operation	
Playback selection	
Playing JPEG Picture CD .....	26
General operation	
Playback selection	
Playing mixed-mode disc (for example, a disc contains MP3, photo and MPEG files) .....	26
Photo file playback	
MPEG file playback	
Special JPEG features .....	27
Zoom picture	
Slide show playback modes	
Playback with multi-angles	
Playing a DivX disc .....	27



## System Menu Options

Basic operations .....	28
SYSTEM SETUP .....	28-30
TV SYSTEM	
SCREEN SAVER	
TV TYPE	
PASSWORD	
RATING	
DEFAULT	
DIVX(R) VOD registration code	
LANGUAGE SETUP .....	30
VIDEO SETUP .....	30
BRIGHTNESS	
CONTRAST	
HUE	
SATURATION	
AUDIO SETUP .....	30-31
DIGITAL OUT	
DOWNMIX	
3D PROCESSING	
LPCM	
NIGHT MODE	

## Radio Reception

Tuning to radio stations .....	32
Programming radio stations .....	32
Automatic programming .....	32
Manual programming .....	32
Tuning to preset radio stations .....	32
RDS .....	33
Setting the RDS clock .....	33

## USB

Using a USB mass storage device .....	34-35
Playing a USB mass storage device	

## Clock/Timer

Clock setting .....	36
Timer setting .....	36
Sleep timer setting .....	36

## Specifications .....

## Troubleshooting .....

## Glossary .....

## Disposal of your old product

Your product is designed and manufactured with high quality materials and components, which can be recycled and reused.



When this crossed-out wheeled bin symbol is attached to a product it means the product is covered by the European Directive 2002/96/EC

Please inform yourself about the local separate collection system for electrical and electronic products.

Please act according to your local rules and do not dispose of your old products with your normal household waste. The correct disposal of your old product will help prevent potential negative consequences for the environment and human health.

# General Information

**Congratulations on your purchase and welcome to Philips!**

**To fully benefit from the support that Philips offers, register your product at [www.philips.com/welcome](http://www.philips.com/welcome).**

## Features

### Additional Component Connections

Lets you connect other audio and audio/visual components to the system so you can use the system's surround sound speakers.

### Parental control (rating level)

Lets you set a rating level so that your children cannot watch a DVD that has a rating higher than you set.

### Sleep timer

Enables the system to switch to standby mode automatically at a preset time.

### Night Mode

Lets you compress the dynamic range, reducing the difference in loudness between different sounds in Dolby Digital mode.

## Discs for playback

### Your DVD System will play:

- Digital Video Discs (DVDs)
- Video CDs (VCDs)
- Super-Video CDs (SVCDs)
- Digital Video Discs + Rewritable (DVD+RW)
- Compact Discs (CDs)
- Picture (Kodak, JPEG) files on CDR(W)
- Windows Media Audio (WMA)
- DivX(R) disc on CD-R(W):
- DivX 3.11, 4.x and 5.x
- Supported MP3-CD format.
- ISO 9660 / UDF format
- Max. title/album name –10 characters
- Max. title number plus album is 255.
- Max. nested directory is 8 levels.
- The max. album number is 32.
- The max. MP3 track number is 999.
- Supported sampling frequencies for MP3 disc: 32 kHz, 44.1 kHz, 48 kHz.
- Supported Bit-rates of MP3 disc are: 32, 64, 96, 128, 192, 256 (kbps).

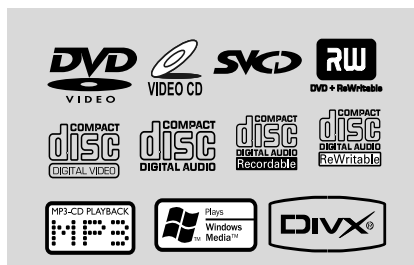

The following formats can't be supported

- The files like \*.VMA, \*.AAC, \*.DLF, \*.M3U, \*.PLS, \*.WAV,
- The discs recorded under Joliet format

## Region Codes

DVDs must be labeled for ALL regions or Region 2 in order to play on this DVD system. You cannot play discs that are labeled for other regions.



### Notes:

- For mixed mode discs, only one mode will be selected for playback according to the recording format.
- If you are having trouble playing a certain disc, remove the disc and try a different one. Improperly formatted discs will not play on this system.
- DTS surround audio output is not available in this DVD player.

## Supplied accessories

- Composite video cable (yellow)
- FM wire antenna
- Remote Control with battery
- This instruction booklet and a quick start guide

## Environmental information

Any unnecessary packaging has been omitted. We have tried to make the packaging easy to separate into three materials: cardboard (box), polystyrene foam (buffer) and polyethylene (bags, protective foam sheet).

Your system consists of materials which can be recycled and reused if disassembled by a specialised company. Please observe the local regulations regarding the disposal of packaging materials, exhausted batteries and old equipment.

## Care and safety information

### Avoid high temperatures, moisture, water and dust

- Where the MAINS plug or an appliance coupler is used as the disconnnet device, the disconnnet device shall remain readily operable.
  - Install the unit near the AC outlet and where the AC power plug can be easily reached.
  - Do not expose the system, batteries or discs to humidity, rain, sand or excessive heat (caused by heating equipment or direct sunlight). Always keep disc trays closed to avoid dust buildup on the lens.
  - No objects filled with liquids, such as vases, shall be placed on the apparatus.
  - No naked flame sources, such as lighted candles, should be placed on the apparatus.
  - The apparatus shall not be exposed to dripping or splashing.
  - **When the system is switched to Standby mode, it is still consuming some power. To disconnect the system from the power supply completely, remove the AC power plug from the wall socket.**
- ### Avoid condensation problem
- The lens may cloud over when the player is suddenly moved from cold to warm surroundings, making it impossible to play a disc. Leave the player in the warm environment until the moisture evaporates.

### Do not block the vents

- Do not operate the system in an enclosed cabinet and allow about 10 cm (4 inches) of free space all around the player for adequate ventilation.

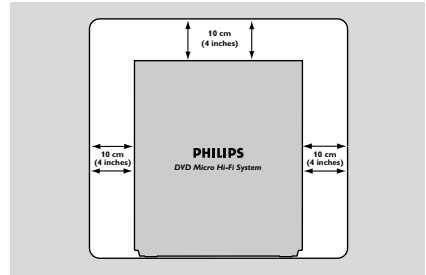

- The ventilation should not be impeded by covering the ventilation openings with items, such as newspapers table-cloths, curtains, etc.

### Cleaning the cabinet

- Use soft cloth slightly moistened with a mild detergent solution. Do not use a solution containing alcohol, spirits, ammonia or abrasives.

### Cleaning discs

- To clean a CD, wipe it in a straight line from the center towards the edge using soft and lint-free cloth. A cleaning agent may damage the disc.
- Write only on the printed side of a CDR(W) and only with a soft felt-tipped pen.
- Handle the disc by its edge. Do not touch the surface.

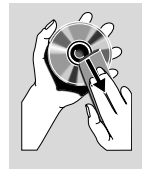

### Cleaning the disc lens

- After prolonged use, dirt or dust may accumulate at the disc lens. To ensure good playback quality, clean the disc lens with Philips CD Lens Cleaner or any commercially available cleaner. Follow the instructions supplied with cleaner.

### Finding a suitable location

- Place the player on a flat, hard, stable surface.
- Install this unit near the AC outlet and where the AC power plug can be reached easily.

## Notes for battery disposal

Your product contains batteries covered by the European Directive 2006/66/EC, which cannot be disposed with normal household waste. Please inform yourself about the local rules on separate collection of batteries because correct disposal helps to prevent negative consequences for the environmental and human health.

## Hearing Safety

### Listen at a moderate volume.

- Using headphones at a high volume can impair your hearing. This product can produce sounds in decibel ranges that may cause hearing loss for a normal person, even for exposure less than a minute. The higher decibel ranges are offered for those that may have already experienced some hearing loss.
- Sound can be deceiving. Over time your hearing "comfort level" adapts to higher volumes of sound. So after prolonged listening, what sounds "normal" can actually be loud and harmful to your hearing. To guard against this, set your volume to a safe level before your hearing adapts and leave it there.

### To establish a safe volume level:

- Set your volume control at a low setting.
- Slowly increase the sound until you can hear it comfortably and clearly, without distortion.

### Listen for reasonable periods of time:

- Prolonged exposure to sound, even at normally "safe" levels, can also cause hearing loss.
- Be sure to use your equipment reasonably and take appropriate breaks.

### Be sure to observe the following guidelines when using your headphones.

- Listen at reasonable volumes for reasonable periods of time.
- Be careful not to adjust the volume as your hearing adapts.
- Do not turn up the volume so high that you can't hear what's around you.
- You should use caution or temporarily discontinue use in potentially hazardous situations.
- Do not use headphones while operating a motorized vehicle, cycling, skateboarding, etc.; it may create a traffic hazard and is illegal in many areas.

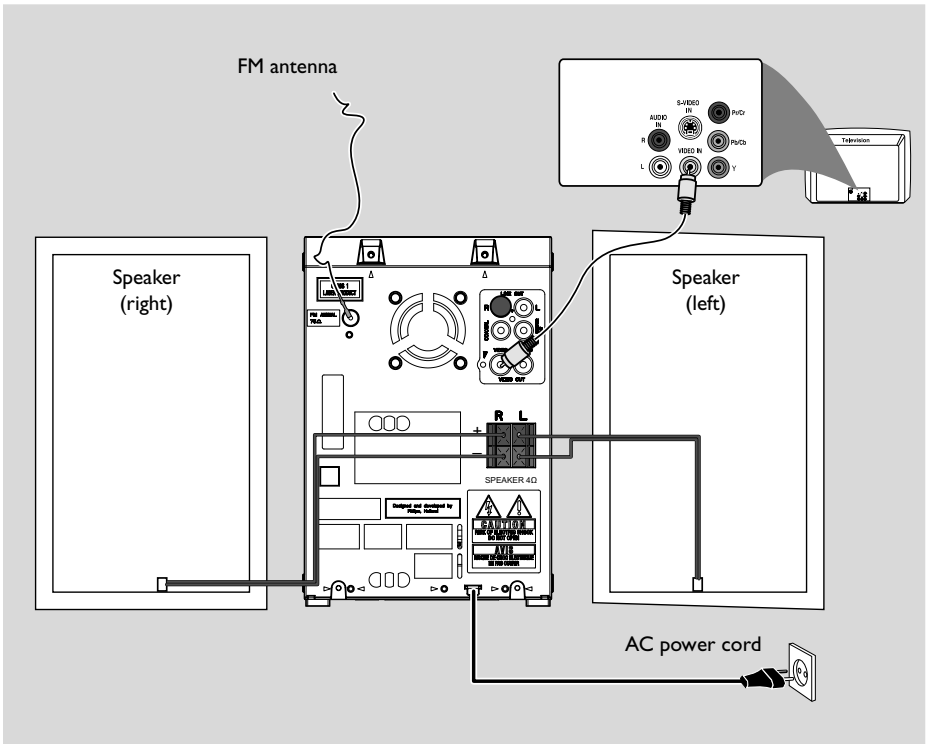

## IMPORTANT!

- The type plate is located at the rear of the system.
- Before connecting the AC power cord to the wall outlet, ensure that all other connections have been made.
- Never make or change any connections with the power switched on.
- **High voltage! Do not open. You run the risk of getting an electric shock.**
- The machine does not contain any user-serviceable parts.
- **Modification of the product could result in hazardous radiation of EMC or other unsafe operation.**

To avoid overheating of the system, a safety circuit has been built in. Therefore, your system may switch to Standby mode automatically under extreme conditions. If this happens, let the system cool down before reusing it (not available for all versions).

## Step 1: Placing speakers

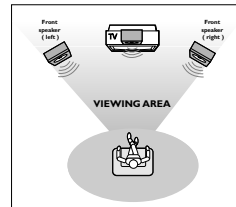

Place the front left and right speakers at equal distances from the TV set and at an angle of approximately 45 degrees from the listening position.

### Notes:

- To avoid magnetic interference, do not position the front speakers too close to your TV set.
- Allow adequate ventilation around the DVD System.

## Step 2: Connecting speakers

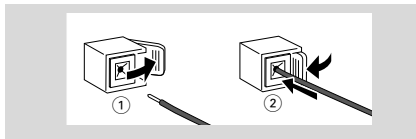

Connect the speaker wires to the **SPEAKER** terminals, right speaker to "R" and left speaker to "L", coloured (marked) wire to "+" and black (unmarked) wire to "-". Fully insert the stripped portion of the speaker wire into the terminal as shown.

### Notes:

- Ensure that the speaker cables are correctly connected. Improper connections may damage the system due to short-circuit.
- For optimal sound performance, use the supplied speakers.
- Do not connect more than one speaker to any one pair of +/- speaker terminals.
- Do not connect speakers with an impedance lower than the speakers supplied. Please refer to the SPECIFICATIONS section of this manual.

## Step 3: Antenna connection

Connect the supplied FM antenna to the respective terminals. Adjust the position of the antenna for optimal reception.

### FM Antenna

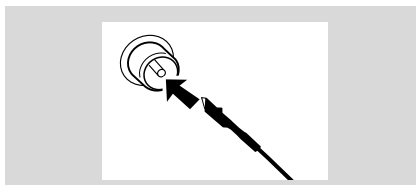

- For better FM stereo reception, connect an outdoor FM antenna to the FM AERIAL (FM ANTENNA) terminal.

## Step 4: Connecting TV

### IMPORTANT!

- You only need to make one video connection from the following options, depending on the capabilities of your TV system.
- Connect the DVD system directly to the TV.

### Using Video In jack (CVBS)

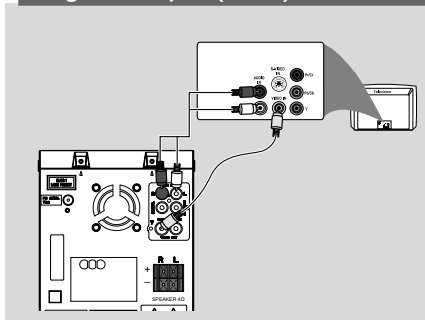

- 1 Use the composite video cable (yellow) to connect the system's **VIDEO** jack to the video input jack (or labelled as A/V In, Video In, Composite or Baseband) on the TV set.
- 2 To hear the sound of this DVD Player through your TV, use the audio cables (white/red-not supplied) to connect **LINE OUT (L/R)** jacks of the DVD Player to the corresponding AUDIO IN jacks on the TV.

### Using S-Video In jack

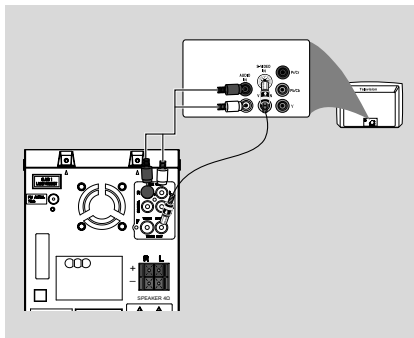

- 1 Use the S-Video cable (not supplied) to connect the system's **S-VIDEO** jack to the S-Video input jack (or labelled as Y/C or S-VHS) on the TV set.
- 2 To hear the sound of this DVD Player through your TV, use the audio cables (white/red-not supplied) to connect **LINE OUT (L/R)** jacks of the DVD Player to the corresponding AUDIO IN jacks on the TV.

## Using an accessory RF modulator

### IMPORTANT!

– If your TV set only has a single **Antenna In** jack (or labelled as 75 ohm or RF In), you will need a RF modulator in order to view the DVD playback via TV. See your electronics retailer or contact Philips for details on RF modulator availability and operations.

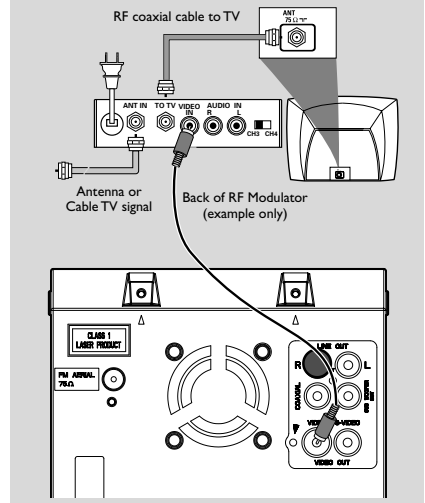

- 1 Use the composite cable (yellow) to connect the system's **VIDEO** jack to the video input jack on the RF modulator.
- 2 Use an RF coaxial cable (not supplied) to connect the RF modulator to your TV's RF jack.

## Step 5: Connecting the power cord

### IMPORTANT!

- Never make or change any connection with the power switched on.

After everything is connected properly, plug in the AC power cord to the power outlet.

## Optional: Connecting additional equipment

### IMPORTANT!

- Some discs are copy-protected. You cannot record the disc through a VCR or digital recording device.
- When making connections, make sure the colour of cables matches the colour of jacks.
- Always refer to the owner's manual of the other equipment for complete connection and usage details.

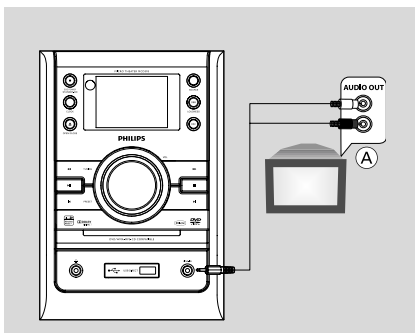

### Listening to the playback of other equipment (A)

Use a cinch cable (not supplied) to connect LINE-IN on the front panel of the DVD player to the analogue audio out terminals of an external equipment (TV, VCR, Laser Disc player; DVD player or CD Recorder).

Before starting operation, press **SOURCE** on the front panel to select **AUX** or press **AUX** on the remote in order to activate the input source.

### Note:

- If you are connecting equipment with a mono output (a single audio out terminal), connect it to the **AUX** left terminal. Alternatively, you can use a "single to double" cinch cable (the output sound still remain mono).

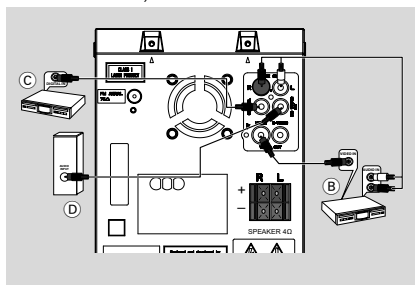

### Using the VCR for recording DVDs (B)

Connect one of the system's **VIDEO OUT** jacks to the corresponding **VIDEO IN** jack and **LINE OUT (RL)** jacks to the **AUDIO IN** jacks on the VCR. This will allow you to make analogue stereo (two channel, right and left) recordings.

### Recording (digital) (C)

Connect the system's **COAXIAL** jack to the **DIGITAL IN** jack on a digital recording device (such as DTS-Digital Theatre compatible, with Dolby Digital decoder).







Before starting operation, set the **DIGITAL OUT** according to the audio connection. (See "DIGITAL OUT".)

### Connecting an active subwoofer (D)

Connect the DVD micro system's **SUBWOOFER OUT** jack to the **AUDIO INPUT** jack on an active subwoofer (not supplied).



## Controls on the system

- ① **iR sensor**
  - infrared sensor for remote control.
- ② **ECO POWER/STANDBY-ON** 
  - switches the system on or to Eco power/normal standby mode.
- ③ **CLOCK**
  - Standby mode
  - sets the system clock.
  - Playback mode
  - displays clock.
- ④ **OPEN•CLOSE** 
  - to open or close the disc door.
- ⑤ **Mode Selection**
  - ..... In DISC/USB mode, to stop playback or clear a program.
  - ▶| ..... In DISC/USB mode, to start or interrupt playback.
  - PRESET**  
    - ..... Disc/USB: skips to the previous/next chapter/title/track.
    - ..... Tuner: selects a preset radio station.
  - TUNING**  
    - Tuner
    - press to tune to a lower/higher radio frequency gradually.
    - press and hold, then release the key to start automatic search for a radio frequency downward/upward.
    - Disc/USB
    - searches fast backward/forward in a disc/USB.
- ⑥ 
  - to connect a headphone.
- ⑦ **USB port**
  - jack for the external USB mass storage device
- ⑧ **LINE-IN** jack
  - to connect an auxiliary device.
- ⑨ **VOL**
  - adjusts the volume upward/downward.
  - adjusts the hours and minutes in clock/timer setting mode.
- ⑩ **DSC**
  - selects different types of preset sound equalizer settings (CLASSIC, JAZZ, POP or ROCK).

- ⑪ **LOUDNESS/DBB**
  - enables or disables automatic loudness adjustment.
  - enables or disables bass enhancement.
- ⑫ **SOURCE**
  - to select the respective sound source : DISC TUNER, USB or AUX.
- ⑬ **Display screen**
  - to view the current status of the system.

## Controls on the remote control

- ① 
  - to switch to the system to standby mode.
- ② **Numeric Keypad (0-9)**
  - inputs a track/title/chapter number of the disc.
- ③ **PROG/ANGLE**
  - DVD/VCD/CD/MP3-CD/USB: enters the program menu.
  - Picture CD: during playback, to select a slide show mode.
  - Tuner: programs preset radio stations.
  - DVD: selects a DVD camera angle.
- ④ **SOURCE**
  - to select the respective sound source : DISC TUNER, USB or AUX.
- ⑤ **SYSTEM MENU** (disc mode only)
  - to enter or exit the system menu bar.

# Controls

- ⑥ **DISC MENU** (disc mode only)
- DVD/VCD: enters or exits the disc contents menu.
  - VCD2.0: switches the playback control mode on or off.
- ⑦ **◀◀▶▶**  
Tuner
- press to tune to a lower/higher radio frequency gradually.
  - press and hold, then release the key to start automatic search for a radio frequency downward/upward.  
Disc
  - (not for MP3 CD) searches backward/forward in a disc at different speeds.
  - In DISC mode, to select a movement direction in the disc menu or system menu bar.
- ⑧ **▲▼**
- In DISC mode, to select a movement direction in the disc menu or system menu bar.
- ⑨ **OK**
- to exit or confirm the selection.
- ⑩ **|◀▶|**
- Disc: skips to the previous/next chapter/title/track.
  - Tuner: selects a preset radio station.
- ⑪ **■**
- In DISC mode, to stop playback or clear a program.
- ⑫ **▶II**
- In DISC mode, to start or interrupt playback.
- ⑬ **VOL +/-**
- adjusts the volume upward/downward.
  - adjusts the hours and minutes in clock/timer setting mode.
- ⑭ **MODE**
- to select various repeat modes or the shuffle play mode for a disc.
- ⑮ **SUBTITLE**
- selects a subtitle language.
- ⑯ **SLEEP/TIMER**  
Standby mode
- sets a time for switching on the system automatically.  
Playback mode
  - sets the sleep timer function (auto-off).
- ⑰ **LOUD/DBB**
- enables or disables automatic loudness adjustment.
  - enables or disables bass enhancement.
- ⑱ **DSC**
- selects different types of preset sound equalizer settings (CLASSIC, JAZZ, POP or ROCK).
- ⑲ **MUTE**
- to interrupt or resume sound reproduction.
- ⑳ **DISPLAY/RDS**  
for disc
- selects a disc information display mode.  
for tuner
  - selects RDS information.
- ㉑ **REPEAT A-B**
- for VCD/CD: to repeat a specific section within the same track.
  - for DVD: to repeat a specific section in a disc.
- ㉒ **AUDIO**  
for VCD
- sets Stereo, Mono-Left or Mono-Right sound mode.  
for DVD
  - selects an audio language.
- ㉓ **ZOOM**
- DVD/VCD/Picture CD: enlarges or reduces a picture or active image on the TV screen.
- ㉔ **GOTO**
- In DISC mode, to fast search in a disc by entering a time, title, chapter or track.

## Notes for remote control:

- **First, select the source you wish to control by pressing one of the source select keys on the remote control (DISC or TUNER, for example).**
- **Then select the desired function (▶II, ◀, ▶I for example).**

## IMPORTANT!

– Make sure to complete the preparation procedures before operating the system.

### Before using the remote control

- 1 Pull out the plastic protective sheet.
- 2 Select the source you wish to control by pressing one of the source select keys on the remote control (for example CD, TUNER).
- 3 Then select the desired function (for example ► II , ◀◀ , ▶▶).

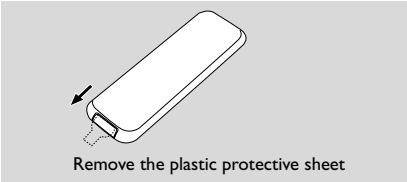

### Replacing battery (lithium CR2025) into the remote control

- 1 Press the slot on the battery compartment.
- 2 Pull out the battery compartment.
- 3 Replace a new battery and fully insert the battery compartment back to the original position.

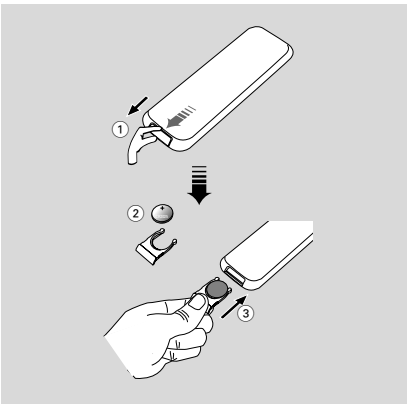

## CAUTION!

Batteries contain chemical substances, so they should be disposed of properly.

### Step 1: Setting the clock

Important!

– To set clock in the Eco Power mode, press and hold ECO POWER/STANDBY-ON  $\odot$  on the set for 3 seconds or more to switch to normal standby mode first before proceeding with the procedures below.

- 1 Go to Standby mode.
- 2 Press and hold **CLOCK** on the front panel.  
→ The hour digits flash on the display screen.
- 3 Turn the **VOL** control on the front panel or press **VOL +/-** on the remote to set the hours.
- 4 Press **CLOCK** again.  
→ The minute digits flash on the display screen.
- 5 Turn the **VOL** control on the front panel or press **VOL +/-** on the remote to set the minutes.
- 6 Press **CLOCK** to confirm the clock setting.

Notes:

- This system only supports 24-hour mode.
- The clock setting will be erased when the system is disconnected from the power supply.
- The system will exit clock setting mode if no button is pressed within 10 seconds.

# Preparations

## Step 2: Setting video preference

### IMPORTANT!

– Make sure you have completed all the necessary connections. (See "Connections-Connecting TV".)

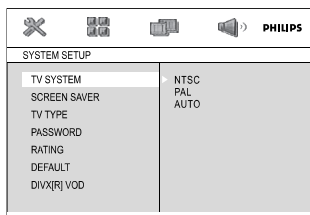

Turn on the TV set and set it to the correct Video-In channel.

→ You may go to channel 1 on your TV set, then press the channel button repeatedly until you see the Video In channel.

→ Or, you can use the TV remote control to select different video modes.

→ Or, set TV to channel 3 or 4 if you are using an RF modulator.

1 In stop mode or during playback, press **SYSTEM MENU**.

2 Press ◀◀▶▶/▲/▼ on the remote control to toggle through the functions and select your preferential option.

→ Move to **SYSTEM SETUP** and press ▼.

→ Move to one of the following and press ▶▶.

### – Setting TV SYSTEM

Allows you to select the colour system matching the connected TV set.

#### NTSC

– If the connected TV is NTSC system, select this mode. It will change the video signal of a PAL disc and output in NTSC format.

#### PAL

– If the connected TV is PAL system, select this mode. It will change the video signal of a NTSC disc and output in PAL format.

#### AUTO

– If the connected TV is multi system, select this mode. The output format will be in accordance with the video signal of the disc.

### – Setting TV TYPE

Select the aspect ratio of the TV to be connected.

#### 4:3 PS (Pan and Scan mode)

– If you have a conventional TV set and your DVD is not formatted for widescreen viewing, use this setting. A wide picture is displayed on the whole TV screen with a portion automatically cut off.

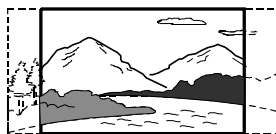

#### 4:3 LB (Letterbox mode)

– If you have a conventional TV set and your DVD is formatted for widescreen viewing, use this setting. A wide picture with bands displayed on the upper and lower portions of the TV screen.



#### 16:9 (Wide screen mode)

– If you have a widescreen TV set, use this setting (you must also set your widescreen TV to "full size") available on a disc, then the disc's own preference will be used.

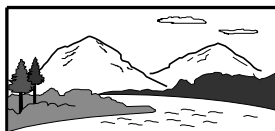

**Note:**

The format you select must be available on the disc. If it is not, the setting for TV Type will not affect the picture during playback.

**To exit the menu**

Press **SYSTEM MENU** again.

## Step 3: Setting language preference

You can select your preferred language settings so that this DVD Micro System will automatically switch to the language for you whenever you load a disc. If the language selected is not available on the disc, the language set by default will be used instead. But the menu language of the DVD Micro System cannot be changed once selected.

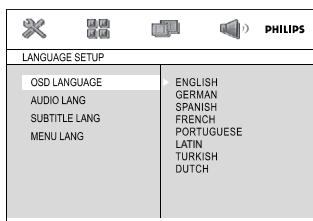

- 1 In stop mode or during playback, press **SYSTEM MENU**.
- 2 Press ◀◀/▶▶/▲/▼ on the remote control to select your preferred option.
  - Move to **LANGUAGE SETUP** and press ▼.
  - Move to one of the following and press ▶▶.

**OSD LANGUAGE** (On-Screen Display)

Switches the display language on the TV screen. Select the language from the displayed list.

**AUDIO LANG** (DVD only)

Switches the display language of the sound track. Select the language from the displayed list.

**SUBTITLE LANG** (DVD only)

Switches the display language of the subtitle. Select the language from the displayed list.

**MENU LANG** (DVD only)

Select the language for the DVD menu.

When the selected language is not recorded in the DVD, one of the recorded languages will be selected automatically (except for OSD).

You can reset all the DVD settings except for Rating.

If the language selected is not available on the disc, the original language designated by each disc will be selected.

- 3 Press ▲/▼ to select a language and press **OK**.
- 4 Repeat **steps 2~3** for other settings.

**To exit the menu**



Press **SYSTEM MENU** again.

# Basic Functions

## Switching the system on

- Press **ECO POWER/STANDBY-ON**  on the front panel.  
→ The system will switch to the last selected source.
- Press **SOURCE** repeatedly (or **DISC TUNER, USB** or **AUX** on the remote).  
→ The system will switch to the selected source.

## Switching the system to Eco Power Standby mode

- Press **ECO POWER/STANDBY-ON**  (or  on the remote) in the active mode.  
→ The system enters Eco power standby (the ECO POWER LED is on) or normal standby with clock display.
- The volume level (up to a maximum volume level of 12), interactive sound settings, last selected mode, source and tuner presets will be retained in the player's memory.
- If the system is normal standby with clock display, press and hold **ECO POWER/STANDBY-ON**  on the front panel for 3 seconds or more to switch to Eco power standby or vice versa.

## Power-saving automatic standby

As a power-saving feature, the system will automatically switch to Standby mode if you do not press any buttons within 15 minutes after a disc has stopped playing.

## Sound Control

**DBB, DSC and LOUDNESS sound features cannot be activated at the same time.**

### DBB (Dynamic Bass Boost)

DBB enhances the bass response.

- Press **LOUDNESS/DBB** on the front panel or press **LOUD/DBB** on the remote to enable/disable DBB feature.  
→ Some discs might be recorded in high modulation, which causes a distortion at high volume. If this occurs, switch off DBB or reduce the volume.

### DSC (Digital Sound Control)

DSC provides a different type of preset sound equalizer setting.

- Press **DSC** repeatedly to select: CLASSIC, JAZZ, POP or ROCK.

### LOUDNESS

LOUDNESS feature enables the system to automatically increase the treble and bass sound effect at low volume (the higher the volume, the lower the treble and bass increase).

- Press **LOUDNESS/DBB** on the front panel or press **LOUD/DBB** on the remote to enable/disable LOUDNESS feature.  
→  icon appears/disappears after this feature is enabled/disabled.

## Volume control

Turn the **VOL** control on the front panel clockwise or anticlockwise or press **VOL +/-** on the remote to increase or decrease the volume level.

→ "VOL X.X" is displayed on the display panel. "X.X" denotes the volume level.

### To listen through the headphone

- Connect the headphone plug to the  socket on the front panel of the DVD player.  
→ The speakers will be muted.



### To switch off the volume temporarily

- Press **MUTE** on the remote.  
→ Playback will continue without sound and "MUTE" appears.
- To activate sound reproduction, you can:
  - press **MUTE** again;
  - adjust the volume controls;
  - change source.

## IMPORTANT!

- This system is designed for regular discs. Therefore, do not use any accessories such as disc stabiliser rings or disc treatment sheets, etc., as offered on the market, because they may jam the disc mechanism.
- Do not move the system during playback. Doing so may damage the system.
- DVD discs and players are designed with regional restrictions. Before playing a disc, make sure the disc matches the regional code of your player.
- According to the format requirement of DVD or VCD, some operations may be different or restricted.
- Do not push on the disc tray or put any objects other than disc on the disc tray. Doing so may cause the disc player malfunction.
- If "INVALID KEY" appears on the TV screen when a button is pressed, it means the function is not available on the current disc at the current time.

## Playing discs

- 1 Connect the power cords of the system and TV (or any optional stereo or AV receiver) to a power outlet.
- 2 Turn on the TV power and set to the correct Video In channel. (See "Setting up the TV".)
- 3 Press **ECO POWER/STANDBY-ON**  on the DVD Player front panel.  
→ You should see the blue Philips DVD background screen on the TV.
- 4 Press **OPEN/CLOSE**  to open the disc door and load in a disc, then press the same button again to close the disc door.  
→ Make sure the label side is facing up.
- 5 Playback will start automatically (depending on the disc type).  
→ If a disc menu appears on the TV, see "Using the Disc Menu".  
→ If the disc is locked by parental control, you must enter your four-digit password. (See "SYSTEM SETUP-PASSWORD".)
- 6 At any time, simply press **■** to stop playback.

## Using the disc menu

For disc with Table Of Contents, a menu may appear on the TV screen once you load the disc.

### To select a playback feature or item

- Use **◀◀/▶▶/▲/▼** and **OK** or **Numeric Keypad (0-9)** on the remote.  
→ Playback will start automatically.

### To access or exit the menu

- Press **DISC MENU** on the remote.

### For VCD with Playback Control (PBC) feature (version 2.0 only)

PBC playback allows you to play Video CDs interactively, following the menu on the display.

- During playback, press **DISC MENU**.  
→ If PBC was ON, it will switch to OFF and continue playback.  
→ If PBC was OFF, it will switch to ON and return to menu screen.

## Basic playback controls

### Pausing playback (DVD/VCD/CD/MP3/WMA)

- 1 During playback, press **▶II**.  
→ Playback will pause and sound will be muted.
- 2 Press **▶II** again to resume.

### Selecting a track/chapter/title (DVD/VCD/CD/MP3/WMA)

- 1 Press **PRESET** **◀|▶** during playback to go to the previous or next chapter/title/track.
- 2 To go directly to any chapter/ title/track, enter the chapter/ title/track number using the **Numeric Keypad (0-9)**.

### Resuming playback from the last stopped point (DVD/VCD/CD/MP3/WMA)

- In stop mode and when a disc has not been removed, press **▶II**.

### To cancel resume mode

- In stop mode, press **■** again.

# Disc Operations

## Zoom (DVD/VCD/JPEG)

Zooming allows you to enlarge or reduce the video image during playback.

- 1 Press **ZOOM** on the remote repeatedly to enlarge or reduce the playback video image.
- 2 Press **◀◀/▶▶/▲/▼** to pan across the TV screen.

## Repeat and shuffle modes (DVD/VCD/CD/MP3/WMA/DivX)

- Press **MODE** repeatedly to choose a repeat mode during playback.

### For DVD CHAPTER

– to repeat playback of the current chapter.

### TITLE

– to repeat playback of the current title.

### OFF

– switches off the repeat mode.

### For VCD/MP3/CD/DivX

#### REP 1

– to repeat playback of the current track.

#### REP DIR (for MP3 only)

– to repeat playback of the current folder.

#### REP ALL

– to repeat playback of the whole disc.

#### SHUF REP ALL ON

– to repeat playback of the whole disc in random order.

#### SHUF REP ALL OFF

– switches off the repeat mode.

## Repeat A-B (DVD/VCD/CD/MP3/WMA)

- 1 Press **REPEAT A-B** at your chosen starting point.
- 2 Press **REPEAT A-B** again at your chosen end point.  
→ The section A and B can be set only within the same chapter/track.  
→ The section will now repeat continuously.
- 3 To exit the sequence, press **REPEAT A-B** again.  
→ "A-B CANCEL" is displayed on the TV screen.

## Program (not for Picture CD)

To select favourite tracks/chapters for playback in preferred sequence.

( Example for the DVD disc menu )

PROG			
T	C	T	C
1	---	5	---
2	---	6	---
3	---	7	---
4	---	8	---
9	---	13	---
10	---	14	---
11	---	15	---
12	---	16	---
PLAY		CLEAR	

- 1 Press **PROG/ANGLE** on the remote control to enter the program mode.
- 2 On the remote control, press **◀◀/▶▶** to select desired sequence number.
- 3 On the remote control, press **▲/▼** or use the **Numerical Keypad (0-9)** to select desired track ( T ), chapter ( C ) or album ( A ) or title ( T ).
  - For MP3, after selecting desired album ( A ) number, press **◀/▶** to go to track ( T ) position, then select desired track number.
  - For DVD, after selecting desired title ( T ) number, press **◀/▶** to go to chapter ( C ) position, then select desired chapter number.
- 4 Repeat steps 2-3 to program other track/ chapter/album/title.
- 5 After completing program, press **OK**.
- 6 Press **◀◀/▶▶** to select PLAY.
- 7 Press **OK** to start playback.



## Forward/Reverse Searching (DVD/VCD/CD/MP3/WMA)

- 1 Press **TUNING** ◀◀/▶▶ during playback to select the required speed: X2, X4, X8 or X20 (backward or forward).  
→ Sound will be muted.
- 2 To return to normal speed, press ▶II.

## Time search & search by chapter/track number (DVD/VCD/CD/MP3/WMA/DivX)

- 1 Press **GOTO** until the time or chapter/track edit box appears.
- 2 Enter hours, minutes and seconds from left to right in the time edit box using the **Numeric Keypad (0-9)** on the remote.  
OR  
Enter your desired chapter/track number in the chapter/track edit box using the **Numeric Keypad (0-9)** on the remote.

## Information display during playback (DVD/VCD/CD/MP3/WMA)

- During playback, press **DISPLAY/RDS** on the remote to show disc information on the TV screen.

### For DVD/VCD/CD

- Elapsed playback time of the current track/ title.
- Remaining playback time of the current track/ title.
- Elapsed playback time of the whole disc.
- Remaining playback time of the whole disc.
- Display off.

### For MP3 CD

- Elapsed playback time of the current track.
- Remaining playback time of the current track.

## Special disc features

### Playing a Title (DVD)

- 1 Press **DISC MENU**.  
→ The disc title menu appears on the TV screen.
- 2 Use ◀◀/▶▶/▲/▼ to select a play option.
- 3 Press **OK** to confirm.

### Camera Angle (DVD)

- Press **PROG/ANGLE** on the remote repeatedly to select different desired angle.

### Changing the Audio Language (for DVD recorded with multiple languages)

- Press **AUDIO** on the remote repeatedly to select different audio languages.

### Changing the Audio Channel (for VCD only)

- Press **AUDIO** on the remote to select the available audio channels provided by the disc (Mono Left, Mono Right or Stereo).

### Subtitles (DVD)

- Press **SUBTITLE** on the remote repeatedly to select different subtitle languages.

# Disc Operations

## Playing MP3/WMA/JPEG Disc

### IMPORTANT!

– You have to turn on your TV and set to the correct Video In channel. (See "Setting up the TV".)

## Playing MP3/WMA disc

### General operation

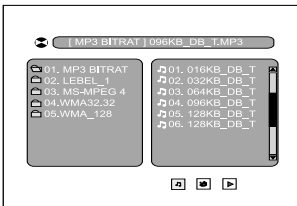

- 1 Load an MP3/WMA disc.  
→ A data disc menu appears on the TV screen and playback starts automatically from the first track.
- 2 Press ▲/▼ to select a directory.
- 3 Press **PRESET** ◀|▶ to select a track. Or directly use the **Numeric Keypad (0-9)** to select a track in the current directory.  
→ The playback will start from the selected track to the end of the directory.

### Notes:

- Do not input a number larger than the number of tracks in the current directory.
- The disc reading time may exceed 10 seconds due to large number of songs compiled onto the disc.

## Playing JPEG Picture CD

### General operation

- 1 Load a JPEG Picture CD.  
→ A data disc menu appears on the TV screen and playback starts automatically from the first file.
- 2 Press ▲/▼ to select a folder.
- 3 Press **PRESET** ◀|▶ to select a file. Or directly use the **Numeric Keypad (0-9)** to select a file in the current folder.  
→ The playback will start from the selected picture to the end of the folder.

### Playback selection

During playback, you can:

- Press **PRESET** ◀|▶ to select another file in the current folder.
- Use ◀◀/▶▶/▲/▼ on the remote to rotate/flip the picture files.
- Press ▶|| repeatedly to pause/resume playback.
- Press ■ to stop playback and return to the disc content menu.

## Playing mixed-mode disc (for example, a disc contains MP3, photo and MPEG files)

You can play a mixed-mode disc through this DVD micro system. After loading of such a disc, a data disc menu will appear on the TV screen and playback will start automatically from the MP3 files. The MP3 file operation is the same as that described above (see "Playing MP3/WMA disc").

### Photo file playback

- 1 Press **SUBTITLE, DISC MENU** and ◀◀/▶▶ to select the 📷 icon and then press OK to select a photo directory.
  - 2 Press ▲ to enter the photo playback mode and press ▲/▼ to select a photo.
  - 3 Press ▶|| or **OK** to play the photos sequentially starting from the one you selected.
- During sequential playback, press ◀|▶ to select the next/previous photo, press ▶|| to pause, or press ■ to stop the playback.

### MPEG file playback

- 1 Press **SUBTITLE, DISC MENU** and ◀◀/▶▶ to select the 📺 icon and then press **OK** to select a MPEG directory.
  - 2 Press ▲/▼ / ◀◀/▶▶ to select a MPEG file and press **OK** to play this MPEG file.
- At any time, simply press ■ to stop playback.

### To return to MP3 playback mode again

- Press **SUBTITLE** and ◀◀/▶▶ to select the 📷 icon.

## Special JPEG features

### Zoom picture (JPEG)

- During playback, press **ZOOM** repeatedly to display the picture with different scales (X2, X3, X4, X1/2, X1/3 and X1/4).
- Use ◀◀/▶▶/▲/▼ to view the zoomed picture.

### Slide show playback modes (JPEG)

- During playback, press **PROG/ANGLE** repeatedly to select different slide-show playback modes:
  - Mode 0: NONE
  - Mode 1: WIPE TOP
  - Mode 2: WIPE BOTTOM
  - Mode 3: WIPE LEFT
  - Mode 4: WIPE RIGHT
  - Mode 5: DIAGONAL WIPE LEFT TOP
  - Mode 6: DIAGONAL WIPE RIGHT TOP
  - Mode 7: DIAGONAL WIPE LEFT BOTTOM
  - Mode 8: DIAGONAL WIPE RIGHT BOTTOM
  - Mode 9: EXTEND FROM CENTER H
  - Mode 10: EXTEND FROM CENTER V
  - Mode 11: COMPRESS TO CENTER H
  - Mode 12: COMPRESS TO CENTER V
  - Mode 13: WINDOW H
  - Mode 14: WINDOW V
  - Mode 15: WIPE FROM EDGE TO CENTER
  - Mode 16: RANDOM

### Playback with multi-angles (JPEG)

- During playback, press ◀◀/▶▶/▲/▼ to rotate the picture on the TV screen.
  - ▲: flip the picture vertically.
  - ▼: flip the picture horizontally.
  - ◀◀: rotate the picture anti-clockwise.
  - ▶▶: rotate the picture clockwise.

## Playing a DivX disc

This DVD player supports the DivX movie playback that you download from your computer onto a CD-R/RW.

- 1 Load a DivX disc.
- 1 Press ▶|| on the remote control to start playback.
- 2 If the DivX movie contains external subtitles, the subtitle menu will appear on the TV screen for your selection.
  - In this case, pressing **SUBTITLE** on the remote control will turn on or off the subtitle.
  - If multilingual subtitles are embedded on the DivX disc, pressing **SUBTITLE** will change the subtitle language during playback.

### Note:

- Subtitle files with the following filename extensions (.srt, .smi, .sub, .ssa, .ass) are supported but do not appear on the file navigation menu.
- The subtitle filename have to be the same as the filename of the movie.
- For DivX discs, only subtitles in the following languages are supported: Danish, Norwegian, English, Spanish, French, German, Portuguese, Swedish, and Italian.

# System Menu Options

## Basic operations

- 1 Press **SYSTEM MENU** to enter the Setup Menu.
- 2 Press **◀/▶** to select a page to be set.
- 3 Press **▲/▼** to highlight an option.
- 4 Enter its submenu by pressing **▶▶** or **OK**.
- 5 Move the cursor by pressing **▲/▼** to highlight the selected item.  
→ In cases of value setting, press **▲/▼** to adjust values.
- 6 Press **OK** to confirm.

### To return to the upper-level menu

- Press **◀◀**.

### To exit from the menu

- Press **SYSTEM MENU** again.  
→ The settings will be stored in the player's memory even if the player is switched off.

#### Note:

– Some of the features in the System Menu Options are described in "Preparations".

## SYSTEM SETUP

The options included in SYSTEM SETUP page are: "TV SYSTEM", "SCREEN SAVER", "TV TYPE", "PASSWORD", "RATING", "DEFAULT" and "DIVX(R) VOD".

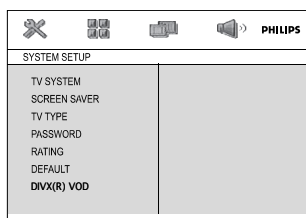

### TV SYSTEM

See "Preparations-Step 3: Setting video preference" for details.

### SCREEN SAVER

This function is used to turn the screen saver on or off.

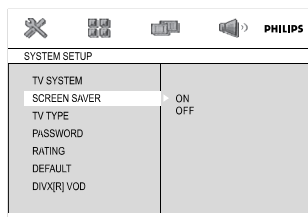

→ **ON**: In STOP, PAUSE or No DISC mode, if no actions are performed about 3 minutes, the screen saver will be activated.

→ **OFF**: Screen saver is disabled.

### TV TYPE

See "Preparations-Step 3: Setting video preference" for details.

### PASSWORD

You can enter your four-digit password to activate or deactivate rating control.

→ "🔒" is displayed if rating control is activated.

→ "🔓" is displayed if rating control is deactivated.

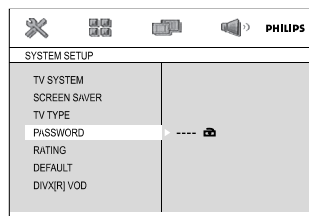

### To change password

- 1 Move to "PASSWORD" and press **▶▶** or **OK** to enter its submenu.
- 2 If "🔒" is displayed, enter the default password (0000) and press **OK** to unlock.
- If "🔒" is displayed, directly proceed with Step 3 and 4.
- 3 Enter your new four-digit password using Numeric Keypad (0-9) on the remote.
- 4 Press **OK** to confirm and the new password takes effect.

#### Note:

– The default password (0000) is always active even if the password has been changed.

## RATING

Some DVDs may have a parental level assigned to the complete disc or to certain scenes on the disc. This feature lets you set a playback limitation level.

The rating levels are from 1 to 8 and are country dependent. You can prohibit the playing of certain discs that are not suitable for your children or have certain discs played with alternative scenes.

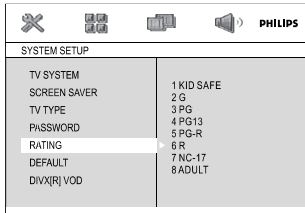

- VCD, SVCD and CD have no level indication, so parental control function has no effect on those kinds of discs. This applies to most illegal DVD discs.
- ① Press ▲/▼ to highlight "RATING".
- ② Enter its submenu by pressing ►►.
- ③ Use ▲/▼ to highlight a rating level for the disc inserted.  
→ DVDs that are rated above the level you selected will not play unless you enter your four-digit password and choose a higher level rating.

### Note:

– Some DVDs are not encoded with a rating though the movie rating may be printed on the Disc cover. The rating level feature does not work for such Discs.

## Rating explanations

### 1 KID SAFE

– Suitable for children.

### 2 G

– General Audience; recommended as acceptable for viewers of all ages.

### 3 PG

– Parental Guidance suggested.

### 4 PG 13

– Material is unsuitable for children under age 13. Parental Guidance suggested.

### 5-6 PG-R, R

– Parental Guidance – Restricted; recommended that parents restrict children under 17 from viewing or allow them to view only when supervised by a parent or adult guardian.

### 7 NC-17

– No children under age 17; not recommended for children under age 17.

### 8 ADULT

– Material for adults only; viewed only by adults due to graphic sexual scenes, violence, or language.

## DEFAULT

Setting the "Default" function will reset all options and your personal settings to the factory defaults and all your personal settings will be erased.

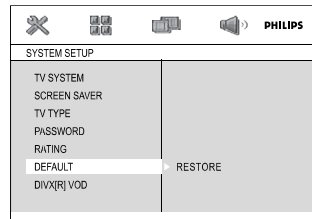

- ① Press ▲/▼ to highlight "DEFAULT".
- ② Highlight RESTORE by pressing ►►.
- ③ Press **OK** to confirm selection.

### Caution!

– **When this function is activated, all settings will be reset to factory defaults.**

# System Menu Options

## DIVX(R) VOD registration code

Philips provides you the DivX® VOD (Video On Demand) registration code that allows you to rent and purchase videos using the DivX® VOD service.

For more information, visit us at [www.divx.com/vod](http://www.divx.com/vod).

1 In SYSTEM SETUP page, press ▲ ▼ to highlight DIVX(R) VOD.

→ The registration code will appear.

2 Use the registration code to purchase or rent the videos from DivX® VOD service at [www.divx.com/vod](http://www.divx.com/vod). Follow the instructions and download the video onto a CD-R for playback on this DVD player.

### Notes:

- All the downloaded videos from DivX® VOD can only be played back on this DVD player.
- Time search feature is not available during DivX movie playback.

## LANGUAGE SETUP

The options included in LANGUAGE SETUP page are: "OSD LANGUAGE", "AUDIO LANG", "SUBTITLE LANG" and "MENU LANG".

See "Preparations-Step 4: Setting language preference" for details.

## VIDEO SETUP

The options included in VIDEO SETUP page are: "COMPONENT", "BRIGHTNESS", "CONTRAST", "HUE" and "SATURATION".

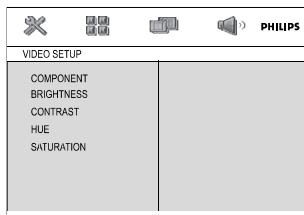

### BRIGHTNESS

Adjusts the brightness level. Range: 0-12.

### CONTRAST

Adjusts the contrast level. Range: 0-12.

### HUE

Adjusts the hue level. Range: -6-+6.

### SATURATION

Adjusts the saturation level. Range: 0-12.

### Note:

*The default settings of "COMPONENT" and "TV MODE" cannot be changed, which are "SVIDEO" and "INTERLACE" respectively.*

## AUDIO SETUP

The options included in AUDIO SETUP page are: "DIGITAL OUT", "DOWNMIX", "LPCM" and "NIGHT MODE".

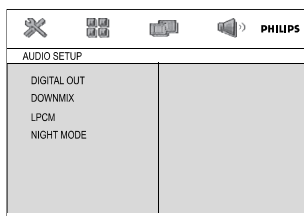

## DIGITAL OUT

- **DIGITAL/OFF**: Turns off the digital output.
- **DIGITAL OUT**: If you have connected your DIGITAL OUT to a multi-channel decoder/receiver.
- **DIGITAL/PCM**: Only if your receiver is not capable of decoding multi-channel audio.

## DOWNMIX

These options allow you to set the stereo analogue output of your DVD Player:

- **LT/RT**: Select this option if your DVD Player is connected to a Dolby Pro Logic decoder.
- **STEREO**: Select this option when output delivers sound from only the two front speakers.

## LPCM

If you connect the DVD Player to a PCM compatible receiver via the coaxial terminal, you may need to adjust 'LPCM'.

Discs are recorded at a certain sampling rate. The higher the sampling rate, the better the sound quality.

- **48K**: Playback a disc recorded at the sampling rate of 48kHz.
- **96K**: Playback a disc recorded at the sampling rate of 96kHz.
- **192K**: Playback a disc recorded at the sampling rate of 192kHz.

## NIGHT MODE

- **OFF**: Select this when you want to enjoy the surround sound with its full dynamic range.
- **ON**: Select this to level out the volume. High volume outputs will be softened and low volume outputs are brought upward to an audible level. This feature is only available for movies with Dolby Digital mode.

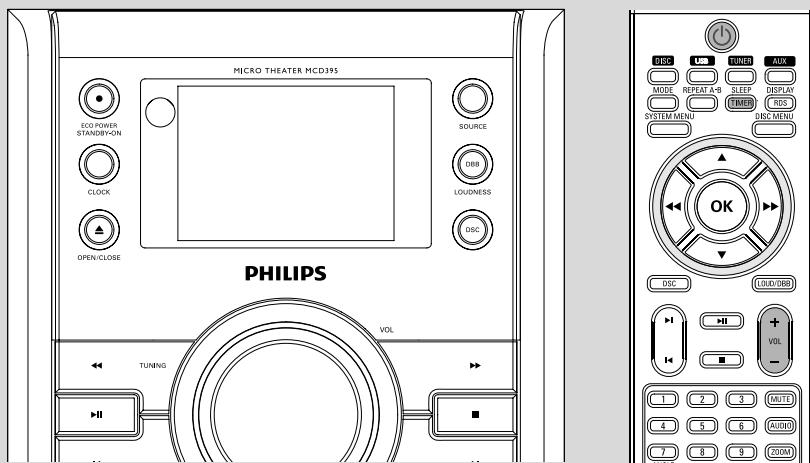

## Tuning to radio stations

- 1 Press **SOURCE** on the set or **TUNER** on the remote repeatedly until the desired waveband (FM) is displayed.
- 2 Press and hold **TUNING** ◀◀/▶▶ and release the button.  
→ The radio automatically tunes to a station with sufficient reception.
- 3 Repeat step 2 if necessary until you find the desired station.
- To tune to a weak station, press **TUNING** ◀◀/▶▶ briefly and repeatedly until you have found optimal reception.

## Programming radio stations

You can store up to a total of 40 radio stations in the memory.

### Automatic programming

Automatic programming will start with a chosen preset number. From this preset number upwards, former programmed radio stations will be overridden.

- 1 Press **PRESET** ◀/▶ to select the preset number where programming should start.

Note:

- If no preset number is selected, default is preset (1) and all your presets will be overridden.
- 2 Press **PROG/ANGLE** on the remote for more than three seconds to activate programming.  
→ All available stations are programmed.

### Manual programming

- 1 Tune to your desired station (refer to "Tuning to radio stations").
- 2 Press **PROG/ANGLE** to activate programming.  
→ **PROG** flashes on the display.
- 3 Press **PRESET** ◀/▶ to allocate a number from 1 to 40 to this station.
- 4 Press **PROG/ANGLE** again to confirm the setting.  
→ **PROG** disappears.
- 5 Repeat the four steps above to store other stations.
- You can overwrite a preset station by storing another frequency in its place.

## Tuning to preset radio stations

- Press **PRESET** ◀/▶ until the desired preset station is displayed.



## RDS

**Radio Data System** is a service that allows FM stations to show additional information. If you are receiving a RDS station, **R·D·S** and the station name are displayed.

When automatic programming is used, RDS stations will be programmed first.

### Scrolling through different RDS information

- Press **DISPLAY/RDS** briefly and repeatedly to scroll through the following information (if available):
  - Station name
  - Radio text messages
  - Frequency

### Setting the RDS clock

Some RDS radio station may be transmitting a real clock time at an interval of every minute. It is possible to set the clock by using a time signal which is broadcast together with the RDS signal.

- 1 Tune to a RDS station (refer to "Tuning to radio stations").
- 2 Press **DISPLAY/RDS** for more than two seconds.
  - "SERV TM" is displayed.
  - When RDS time is read, "RDS" and RDS time value are displayed and the current time will be stored.

#### Note:

- *Some RDS radio station may be transmitting a real time clock at a minute interval. The accuracy of the transmitted time depends on the transmitting RDS radio station.*

## Using a USB mass storage device

By connecting a USB mass storage device to the Hi-Fi system, you can enjoy the music stored on the external device through the powerful speakers of Hi-Fi system.

### Compatible USB mass storage devices

With the Hi-Fi system, you can use

- USB flash memory (USB 2.0 or USB1.1)
- USB flash players (USB 2.0 or USB1.1)
- memory cards (requires an additional card reader to work with this Hi-Fi system)

#### Note:

– In some USB flash players (or memory devices), the stored contents are recorded using copyright protection technology. Such protected contents will be unplayable on any other devices (such as this Hi-Fi system).

### Supported formats:

- USB or memory file format FAT12, FAT16, FAT32 (sector size: 512 - 65,536 bytes)
- MP3 bit rate (data rate): 32-320 Kbps and variable bit rate
- WMA v9 or earlier
- Directory nesting up to a maximum of 8 levels
- Number of albums/ folders: maximum 99
- Number of tracks/titles: maximum 500
- ID3 tag v2.0 or later
- File name in Unicode UTF8 (maximum length: 128 bytes)

### The system will not play or support the following:

- Empty albums: an empty album is an album that does not contain MP3/WMA files, and will not be shown in the display.
- Non-supported file formats are skipped. This means that e.g.: Word documents .doc or MP3 files with extension .dlf are ignored and will not be played.
- AAC, WAV, PCM audio files
- DRM protected WMA files
- WMA files in Lossless format

## How to transfer music files from PC to a USB mass storage device

By dragging and dropping music files, you can easily transfer your favorite music from PC to a USB mass storage device.

For the flash player, you can also use its music management software for the music transfer:

**However, those WMA files may be unplayable for compatibility reasons.**

## How to organize your MP3/WMA files on the USB mass storage device

This Hi-Fi system will browse the MP3/WMA files in the folders/sub-folders/titles order.

Example:

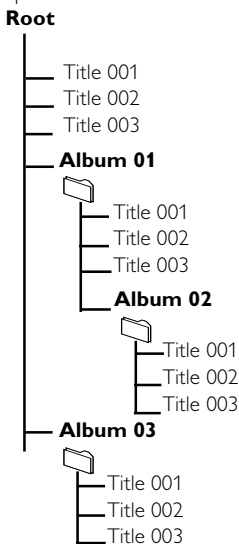

Organize your MP3/WMA files in different folders or subfolders as required.

#### Note:

- If you have not organized MP3/WMA files into any albums on your disc, an album "00" will be automatically assigned for all those files.
- Make sure that the file names of MP3 files end with .mp3, and the file names of WMA files end with .wma.
- For DRM protected WMA files, use Windows Media Player 10 (or later) for conversion. Visit [www.microsoft.com](http://www.microsoft.com) for details about Windows Media Player and WM DRM (Windows Media Digital Rights Management).

### Playing a USB mass storage device

- 1 Check the USB device has been properly connected. (See **Connections: Connecting an additional equipment**)
- 2 Press **SOURCE** once or more to select **USB** (or **USB** on the remote control).
  - The icon  appears.
  - **NO TRACK** appears if no audio file is found in the USB device.
- 3 Play the USB's audio files as you do with the albums/tracks on a CD (See **CD**).

#### Note:

- For compatibility reasons, the album/track information may differ from what it is displayed through flash players' music management software.
- File names or ID3 tags will be displayed as ---- if they are not in English.

### INFORMATION REGARDING USB DIRECT:

1. *Compatibility of the USB connection on this micro system:*
  - a) *This micro system supports most USB Mass storage devices (MSD) that these devices are compliant to the USB MSD standards.*
    - i) *Most common Mass storage class devices are flash drives, memory sticks, jump drives and etc.*
    - ii) *If you see a "Disc Drive" showing up on your computer after you have plugged the mass storage device into your computer, most likely it is MSD compliant and it will work with this micro system.*
  - b) *If your Mass storage device requires a battery/ power source, please make sure you have a fresh battery in it or charge the USB device first and then plug it into the micro system again.*
- 2) *Supported Music type:*
  - a) *This device only supports unprotected music with file extension: .mp3 .wma*
  - b) *Music bought from on-line music stores are not supported because they are secured by Digital Rights Management protection (DRM).*
  - c) *File name extensions that ended with the following are not supported: .wav; .m4a; .m4p; .mp4; .aac and etc.*
- 3) *No Direct connection can be made from a Computer USB port to the micro system even you have either or both mp3 or wma file in your -computer.*

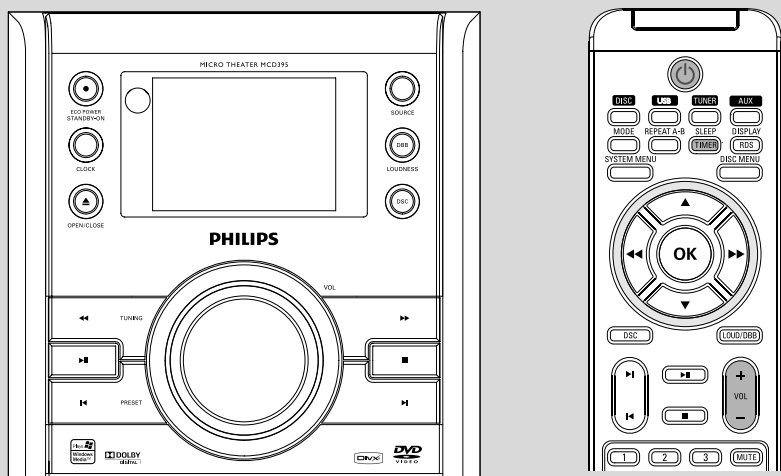

## Clock setting

See "Preparations-Step 2: Setting the clock".

## Timer setting

- The system can be used as an alarm clock, whereby the selected source (DISC, TUNER or USB) starts playback at a preset time. **Make sure the clock is set before using the timer.**
- 1 In standby mode, press and hold **SLEEP/TIMER** on the remote control until  appears. → *SELECT SOURCE* displays.
- 2 Press **SOURCE** on the set repeatedly to select the source (or press **DISC, TUNER** or **USB** on the remote control).
- 3 Press **SLEEP/TIMER** to confirm. → The hours digits start flashing.
- 4 Turn the **VOL** control on the front panel or press **VOL +/-** on the remote to set the hours and press **SLEEP/TIMER** to confirm. → The minute digits flash on the display panel.
- 5 Turn the **VOL** control on the front panel or press **VOL +/-** on the remote to set the minutes and press **SLEEP/TIMER** to confirm.

## Activating and deactivating TIMER



- In standby mode, press **SLEEP/TIMER** on the remote once or more to activate or deactivate the timer:  
→ Display shows  if activated, and disappears if deactivated.

## Sleep timer setting

The sleep timer enables the system to switch off by itself after a set period of time.

- 1 In active mode, press **SLEEP/TIMER** on the remote control repeatedly to select a preset time.  
→ The selections are as follows (time in minutes):  
*SLEEP OFF* → *SLEEP 10* → *SLEEP 20* → *SLEEP 30* → *SLEEP 40* → *SLEEP 50* → *SLEEP 60* → *SLEEP 70* → *SLEEP 80* → *SLEEP 90* → *SLEEP OFF*
- 2 When you reach the desired length of time, stop pressing the **SLEEP/TIMER** button.

### To deactivate the sleep timer

- Press **SLEEP/TIMER** repeatedly until "SLEEP OFF" is displayed, or press **ECO POWER/STANDBY ON**  (or  on the remote).

## AMPLIFIER

Output power .....	2 x 50 W RMS
Signal-to-noise ratio .....	≥ 60 dBA
Frequency response .....	63 – 16000 Hz, ± 3 dB
Input sensitivity AUX .....	0.5 V (max. 2 V)
Impedance loudspeakers .....	4 Ω
Impedance headphones .....	32 Ω -1000 Ω

## DVD PLAYER

Laser Type .....	Semiconductor
Disc Diameter .....	12cm / 8cm
Video Decoding .....	MPEG-2 / MPEG-1
Video DAC .....	10 Bits
Signal System .....	PAL / NTSC
Video Format .....	4:3 / 16:9
Video S/N .....	56 dB (minimum)
Composite Video Output .....	1.0 Vp-p, 75 Ω
S-Video Output .....	Y - 1.0 Vp-p, 75 Ω
.....	C - 0.286 Vp-p, 75 Ω
Audio DAC .....	24 Bits / 96 kHz
Frequency Response ....	4 Hz - 20 kHz (44.1kHz)
.....	4 Hz - 22 kHz (48kHz)
.....	4 Hz - 44 kHz (96kHz)
Digital Output .....	.....
.....	SPDIF (Sony Philips digital interface) Coaxial
Number of programmable tracks .....	16
Signal-to-noise ratio .....	≥ 65 dBA
Channel separation .....	≥ 40 dB (1 kHz)
Total harmonic distortion .....	< 0.1% (1 kHz)

## TUNER

FM wave range .....	87.5 – 108 MHz
Sensitivity at 75 Ω	
– mono, 26 dB signal-to-noise ratio .....	2.8 μV
– stereo, 46 dB signal-to-noise ratio .....	61.4 μV
Selectivity .....	≥ 28 dB
Total harmonic distortion .....	≤ 5%
Frequency response .....	63 – 5500 Hz (-6 dB)
Signal-to-noise-ratio .....	≥ 50 dBA

## USB PLAYER

USB .....	V2.0/ V1.1
.....	support MP3/WMA/JPEG files
Number of albums/ folders.....	maximum 99
Number of tracks/titles .....	maximum 500

## SPEAKERS

2-way bass reflex system

## GENERAL INFORMATION

AC Power .....	220 – 230 V / 50 Hz
Standby power consumption .....	≤ 7W
Eco power Standby .....	< 1W

## Dimensions

Main Unit(w x h x d) .....	152 x 228 x 285 (mm)
Speakers (w x h x d) .....	.....
.....	152 x 228 x 257 (mm)

## Weight

With Packing .....	9.58 kg
Main Unit .....	3.80 kg
Speaker box .....	4.22 kg

**Specifications and external appearance are subject to change without notice.**

# Troubleshooting

## WARNING

Under no circumstances should you try to repair the system yourself, as this will invalidate the warranty. Do not open the system as there is a risk of electric shock.

If a fault occurs, first check the points listed below before taking the system for repair. If you are unable to remedy a problem by following these hints, consult your dealer or Philips for help.

Problem	Solution
<b>No power.</b>	<ul style="list-style-type: none"><li>✓ Check if the AC power cord is properly connected.</li></ul>
<b>“NO DISC” is displayed.</b>	<ul style="list-style-type: none"><li>✓ Check if the disc is inserted upside down.</li><li>✓ Wait until the moisture condensed at the lens has cleared.</li><li>✓ Replace or clean the disc, see “Maintenance”.</li><li>✓ Use a readable disc or correctly recorded format MP3-CD.</li></ul>
<b>No picture.</b>	<ul style="list-style-type: none"><li>✓ Select the appropriate video input mode on the TV set.</li><li>✓ Check if the TV set is switched on.</li><li>✓ Check the video connection.</li><li>✓ Check if the system is securely connected.</li></ul>
<b>Distorted or poor picture.</b>	<ul style="list-style-type: none"><li>✓ Sometimes a slight picture distortion may appear. This is not a malfunction.</li><li>✓ Clean the disc.</li><li>✓ Connect the system to the S-video input of your TV set.</li></ul>
<b>The aspect ratio of the screen cannot be changed even though you have set the TV shape.</b>	<ul style="list-style-type: none"><li>✓ The aspect ratio is fixed on the DVD disc.</li><li>✓ The aspect ratio may not be changed for some TV systems.</li></ul>
<b>The DVD player does not start playback.</b>	<ul style="list-style-type: none"><li>✓ Insert a readable disc.</li><li>✓ Check the disc type, color system and region code.</li><li>✓ Clean the disc.</li><li>✓ Place the disc with the playback side down.</li><li>✓ Press SYSTEM MENU to turn off the setup menu.</li><li>✓ Cancel the parental control rating function or change the rating level.</li><li>✓ Moisture has condensed inside the system. Remove the disc and leave the system turned on for about an hour.</li></ul>
<b>The DVD player does not respond when buttons are pressed.</b>	<ul style="list-style-type: none"><li>✓ Disconnect the power plug from the jack, and insert again.</li></ul>

Problem	Solution
<b>The language for the sound or subtitle cannot be changed when playing a DVD.</b>	<ul style="list-style-type: none"> <li>✓ Multi-language sound or subtitle is not recorded on the DVD.</li> <li>✓ Changing the language for the sound or subtitle is prohibited on the DVD.</li> </ul>
<b>No image is output when a function is selected.</b>	<ul style="list-style-type: none"> <li>✓ Make sure the component is connected correctly.</li> <li>✓ Press the correct function button for the input source.</li> </ul>
<b>Sound cannot be heard or is of poor quality</b>	<ul style="list-style-type: none"> <li>✓ Adjust the volume.</li> <li>✓ Disconnect the headphones.</li> <li>✓ Check that the speakers are connected correctly.</li> <li>✓ Check if the stripped speaker wire is clamped.</li> <li>✓ If the system is in pause, slow motion or fast forward/reverse mode, press PLAY/PAUSE ►   to resume the normal play mode.</li> <li>✓ Make sure the MP3-CD was recorded within 32-256 kbps bit rate with sampling frequencies at 48 kHz, 44.1 kHz or 32 kHz.</li> <li>✓ Ensure that the DTS disc also supports Dolby Digital output.</li> </ul>
<b>Poor radio reception.</b>	<ul style="list-style-type: none"> <li>✓ If the signal is too weak, adjust the antenna or connect an external antenna for better reception.</li> <li>✓ Increase the distance between the System and your TV set or VCR.</li> </ul>
<b>Left and right sound outputs are reversed.</b>	<ul style="list-style-type: none"> <li>✓ Check the speaker connections and location.</li> </ul>
<b>The remote control does not function.</b>	<ul style="list-style-type: none"> <li>✓ Point the remote control at the remote control sensor of the unit.</li> <li>✓ Reduce the distance to the player.</li> <li>✓ Remove any possible obstacles.</li> <li>✓ Replace the batteries with new ones.</li> <li>✓ Check that the batteries are loaded correctly.</li> </ul>
<b>The timer is not working</b>	<ul style="list-style-type: none"> <li>✓ Set the clock correctly.</li> <li>✓ If recording is in progress, stop it</li> </ul>
<b>The Clock/Timer setting is erased</b>	<ul style="list-style-type: none"> <li>✓ Power has been interrupted or the power cord has been disconnected. Reset the clock/timer.</li> </ul>

# Troubleshooting

Problem	Solution
<p><b>The USB device doesn't play on my MCD395.</b></p>	<ul style="list-style-type: none"><li>✓ It is not set in the USB mode. Select USB mode.</li><li>✓ The device is not securely connected to MCD395's USB port. Re-connect the device.</li><li>✓ The device is not supported by MCD395, or the audio file format stored on the device is not supported by MCD395. Use a compatible device/ playable audio file format.</li></ul>



**Analog:** Sound that has not been turned into numbers. Analog sound varies, while digital sound has specific numerical values. These jacks send audio through two channels, the left and right.

**Aspect ratio:** The ratio of vertical and horizontal sizes of a displayed image. The horizontal vs. vertical ratio of conventional TVs is 4:3, and that of wide-screens is 16:9.

**AUDIO OUT Jacks:** Jacks on the back of the DVD System that send audio to another system (TV set, Stereo, etc.).

**Bit Rate:** The amount of data used to hold a given length of music; measured in kilobits per second, or kbps. Or, the speed at which you record. Generally, the higher the bit rate better the sound quality. However, higher bit rates use more space on a Disc.

**Chapter:** Sections of a picture or a music piece on a DVD that are smaller than titles. A title is composed of several chapters. Each chapter is assigned a chapter number enabling you to locate the chapter you want.

**Disc menu:** A screen display prepared for the selection of images, sound, subtitles, multi-angles, etc recorded on a DVD.

**Digital:** Sound that has been converted into numerical values. Digital sound is available when you use the DIGITAL AUDIO OUT COAXIAL or OPTICAL jacks. These jacks send audio through multiple channels, instead of just two channels as analog does.

**Dolby Digital:** A surround sound system developed by Dolby Laboratories containing up to six channels of digital audio (front left and right, surround left and right and center).

**JPEG:** A still-picture data compression system proposed by the Joint Photographic Expert Group, which features small decrease in image quality in spite of its high compression ratio.

**MP3:** A file format with a sound data compression system, "MPE" is the abbreviation of Motion Picture Experts Group 1 (or MPEG-1) Audio Layer 3. Through the MP3 format, one CD-R or CD-RW can contain about 10 times as much data volume as a regular CD can.

**Multichannel:** DVD is specified to have all sound tracks constitute one sound field. Multichannel refers to a structure of sound tracks having three or more channels.

**Parental control:** A function of the DVD to limit playback of the disc by the age of the users according to the limitation level in each country. The limitation varies from disc to disc; when it is

activated, playback will be prohibited if the software's level is higher than the user-set level.

**PCM (Pulse Code Modulation):** A system for converting analog sound signal to digital signal for later processing without data compression.

**Playback control (PBC):** Refers to the signal recorded on video CDs or SVCDs for reproduction control. By using screen menus recorded on a Video CD or SVCD that supports PBC, you can enjoy interactive-type software as well as software having a search function.

**Region code:** A system allowing discs to be played only in preset regions. This unit will only play discs that have compatible region codes. You can find the region code of your unit from the product label. Some discs are compatible with more than one region (or ALL regions).

**S-Video:** Produces a clear picture by sending separate signals for luminance and the color. You can use S-Video only if your TV set has S-Video In jack.

**Sampling Frequency:** Frequency of data sampling when analog data is converted to digital data. Sampling frequency numerically represents how many times the original analog signal is sampled per second.

**Surround:** A system for users to create realistic three-dimensional sound fields full of realism by arranging multiple speakers around the listener.

**Title:** The longest section of a picture or music feature on DVD, music, etc., in video software, or the entire album in audio software. Each title is assigned a title number enabling you to locate the title you want.

**VIDEO OUT jack:** Jack on the back of the DVD System that sends video to TV.

Meet Philips at the Internet  
<http://www.philips.com>

English

Français

Español

Deutsch

Nederlands

Italiano

Svenska

Dansk

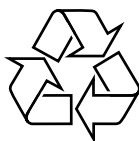

MCD395



© 2010 Koninklijke Philips Electronics N.V.  
All rights reserved.  
MCD395\_UM\_12\_V3.0