

Always there to help you

Register your product and get support at
www.philips.com/support

AJ3232



User manual

PHILIPS

Contents

1	Important	2
	Safety	2

2	Your clock radio	3
	Introduction	3
	What's in the box	3
	Overview of the clock radio	4

3	Get started	5
	Install battery	5
	Connect power	5
	Set time	5
	Set alarm timer	6
	Turn on	7

4	Listen to radio	8
	Tune to radio stations	8
	Store radio stations automatically	8
	Store radio stations manually	8
	Select a preset radio station	8
	Adjust volume	8

5	Other features	9
	Set sleep timer	9
	Adjust brightness	9

6	Product information	10
	Specifications	10

7	Troubleshooting	11
----------	------------------------	-----------

8	Notice	12
----------	---------------	-----------

1 Important

Safety

Know these safety symbols



This 'bolt of lightning' indicates uninsulated material within your unit may cause an electrical shock. For the safety of everyone in your household, please do not remove product covering.

The 'exclamation point' calls attention to features for which you should read the enclosed literature closely to prevent operating and maintenance problems.

WARNING: To reduce the risk of fire or electric shock, this apparatus should not be exposed to rain or moisture and objects filled with liquids, such as vases, should not be placed on this apparatus.

CAUTION: To prevent electric shock, match wide blade of plug to wide slot, fully insert.

Warning

- Never remove the casing of this radio.
- Never lubricate any part of this radio.
- Never place this radio on other electrical equipment.
- Keep this radio away from direct sunlight, naked flames or heat.
- Make sure that you always have easy access to the power cord, plug or adapter to disconnect the radio from the power.

- Read these instructions.
- Follow all instructions.
- Do not use this radio near water.
- Clean only with dry cloth.
- Do not block any ventilation openings. Install in accordance with the manufacturer's instructions.

- Only use attachments or accessories specified by the manufacturer.
- Unplug this radio during lightning storms or when unused for long periods of time.
- Refer all servicing to qualified service personnel. Servicing is required when the radio has been damaged in any way, such as liquid has been spilled or objects have fallen into the apparatus, the radio has been exposed to rain or moisture, does not operate normally, or has been dropped.
- Battery usage **CAUTION** – To prevent battery leakage which may result in bodily injury, property damage, or damage to the radio:
 - Install all batteries correctly, + and - as marked on the radio.
 - Do not mix batteries (old and new or carbon and alkaline, etc.).
 - Remove batteries when the radio is not used for a long time.
- Batteries shall not be exposed to excessive heat such as sunshine, fire or the like.
- The radio shall not be exposed to dripping or splashing.
- Do not place any sources of danger on the radio (e.g. liquid filled objects, lighted candles).
- Where the MAINS plug or an appliance coupler is used as the disconnect device, the disconnect device shall remain readily operable.

Note

- The type plate is located on the bottom of the apparatus.

2 Your clock radio

Congratulations on your purchase, and welcome to Philips! To fully benefit from the support that Philips offers, register your product at www.philips.com/welcome.

Introduction

With this radio, you can

- listen to FM and AM radio;
- know the time; and
- set two alarms to ring at different time.

What's in the box

Check and identify the contents of your package.

- Main unit
- Short user manual

Overview of the clock radio

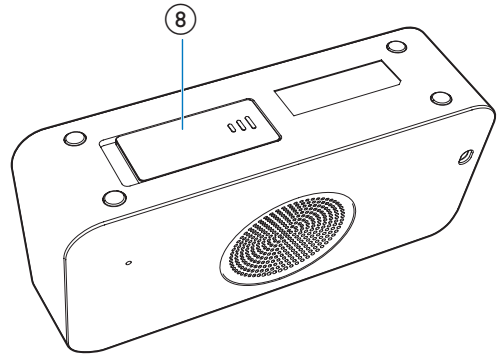
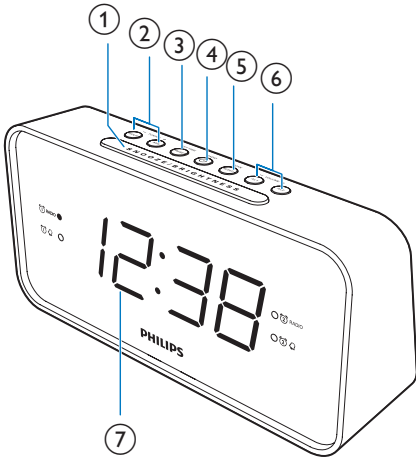

- ① **SNOOZE/BRIGHTNESS**
 - Snooze the alarm.
 - Adjust display brightness.
- ② **HOUR/MIN/- TUNING +**
 - Tune to radio stations.
 - Set hour and minute.
- ③ **PRESET/SET TIME**
 - Store radio stations manually.
 - Select a preset radio station.
 - Set time.
- ④ **⏻/RADIO**
 - Turn on the radio.
 - Switch the radio to standby mode.
 - Select FM or AM radio source.
- ⑤ **SLEEP/SCAN**
 - Set the sleep timer.
 - Scan and store radio stations automatically.
- ⑥ **AL1/AL2/- VOLUME +**
 - Set alarm.
 - Adjust volume.
- ⑦ **Display panel**
 - Display current status.
- ⑧ **Battery compartment**
 - Install battery.

3 Get started

Always follow the instructions in this chapter in sequence.

Install battery

! Caution

- The batteries contain chemical substances, so they should be disposed of properly.

☰ Note

- The batteries can only back up clock and alarm settings when AC power is disconnected.

- 1 Open the battery compartment.

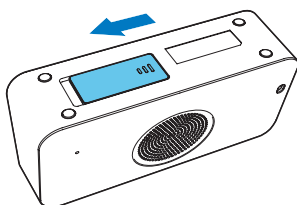

- 2 Insert two AAA batteries (not supplied) with correct polarity (+/-) as illustrated.

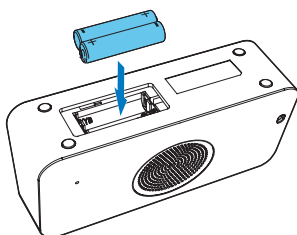

- 3 Close the battery compartment.

Connect power

! Caution

- Risk of product damage! Make sure that the power voltage corresponds to the voltage printed on the back or underside of the radio.
- Risk of electric shock! When you unplug the AC cord, always pull the plug from the socket. Never pull the cord.

Connect the AC power plug to the wall socket.

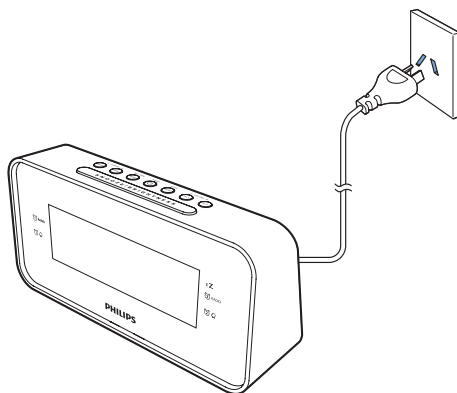

☰ Note

- The display backlight is off when AC power is disconnected.

Set time

☰ Note

- Make sure that the radio is in standby mode.

- 1 Press and hold **SET TIME** for two seconds to activate clock setting mode.
↳ The hour and minute digits blink.
- 2 Press **HOUR** repeatedly to set hour.
- 3 Press **MIN** repeatedly to set minute.

- 4 Press **SET TIME** again to confirm.
 ↳ The set time is displayed.

 Tip

- If there is no operation for 10 seconds, the radio exits time setting mode automatically.

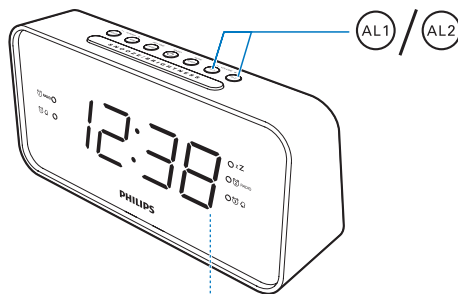

Set alarm timer

You can set two alarms to ring at different time.

 Note

- You can only set the alarm in standby mode.
- Make sure that you have set the clock correctly.

- 1 Press and hold **AL1** or **AL2** for two seconds to activate alarm setting mode.
 ↳ The hour and minute digits blink.
- 2 Press **HOUR** repeatedly to set the hour.
- 3 Press **MIN** repeatedly to set the minute.
- 4 Press **AL1** or **AL2** to confirm.

 Tip

- If you press and hold **HOUR** or **MIN** for two seconds, the hour or minute digits will increase or decrease continuously.
- If there is no operation for 10 seconds, the radio exits alarm setting mode automatically.

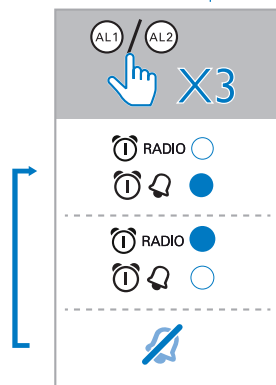

- ↳ If the alarm timer is activated, the alarm indicator for the radio or buzzer is displayed.
- ↳ If the alarm timer is deactivated, the alarm indicator disappears.
- To stop the ringing alarm, press the corresponding **AL1** or **AL2**.
- ↳ The alarm repeats ringing for the next day.

Activate or deactivate the alarm timer

Press **AL1** or **AL2** repeatedly to activate or deactivate the alarm timer.

 Note

- If FM/AM tuner is selected as alarm source, yet you are listening to radio at the preset alarm time, buzzer is activated automatically.
- When the alarm sounds, volume increases gradually to the maximum alarm volume. You cannot adjust the alarm volume manually.

Snooze the alarm

When the alarm sounds, press **SNOOZE**.

- ↳ The alarm snoozes and repeats ringing nine minutes later.

Turn on

Press \odot to turn on the radio.

- ↳ The radio enters FM or AM tuner mode.



Tip

- If there is no operation for 10 seconds, the clock (if set) is displayed.

Switch to standby mode

Press and hold \odot for 2 seconds to switch to standby mode.

4 Listen to radio

Tune to radio stations

Note

- Keep the radio away from other electronic devices to avoid radio interference.
- For better reception, fully extend and adjust the position of the antenna.

- 1 Press **RADIO** repeatedly to select FM or AM radio.
- 2 Press and hold **-TUNING +** for two seconds.
↳ The radio tunes to a station with strong reception automatically.
- 3 Repeat step 2 to tune to more radio stations.

To tune to a station manually:

In tuner mode, press **-TUNING +** repeatedly to select a frequency.

Store radio stations automatically

In FM or AM tuner mode, press and hold **SCAN** for two seconds.

- ↳ The radio stores all the available radio stations, and broadcasts the first available station automatically.

Tip

- To remove a pre-stored station, store another station in its place.

Store radio stations manually

Note

- You can store a maximum of 20 FM radio stations and 20 AM radio stations.

- 1 Tune to a radio station.
- 2 Press and hold **PRESET** for two seconds.
↳ The preset number begins to blink.
- 3 Press **-TUNING +** to select a number.
- 4 Press **PRESET** again to confirm.
- 5 Repeat steps 1 to 4 to store other stations.

Tip

- To remove a pre-stored station, store another station in its place.

Select a preset radio station

In tuner mode, press **PRESET** repeatedly to select a preset station.

Adjust volume

While listening, press **-VOLUME +** to adjust volume.

5 Other features

Set sleep timer

Press **SLEEP** repeatedly to select a time period (in minutes).

- ↳ The radio switches to standby mode automatically after the preset period.
- ↳ When **[OFF]** (off) is displayed, the sleep timer is deactivated.

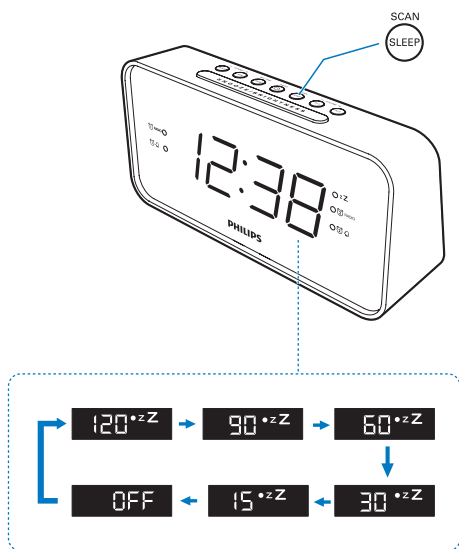

Adjust brightness

Press **BRIGHTNESS** repeatedly to adjust display brightness.

6 Product information



Note

- Product information is subject to change without prior notice.

Specifications

Amplifier

Rated Output Power	0,4 W RMS
--------------------	-----------

Tuner

Tuning Range	FM: 87.5-108 MHz; MW: 531-1602 KHz
--------------	------------------------------------

Tuning Grid	FM: 50 KHz; MW: 9 KHz
-------------	-----------------------

Sensitivity

- Mono, 26 dB S/N Ratio (FM)	<22 dBf
------------------------------	---------

- Mono, 26 dB S/N Ratio (MW)	<75 dBuV
------------------------------	----------

Total Harmonic Distortion	<3%
---------------------------	-----

Signal to Noise Ratio	FM: >50 dBA; MW: >40 dBA
-----------------------	--------------------------

General information

AC power	220-240V~ 50/60Hz
----------	----------------------

Operation Power Consumption	8 W
-----------------------------	-----

Standby Power Consumption	<1 W
---------------------------	------

Dimensions: - Main Unit (W x H x D)	190 x 94 x 62 mm
-------------------------------------	------------------

Weight: - Main Unit	0,54 kg
---------------------	---------

7 Troubleshooting



Warning

- Never remove the casing of this device.

To keep the warranty valid, never try to repair the system yourself.

If you encounter problems when using this device, check the following points before requesting service. If the problem remains unsolved, go to the Philips Web page (www.philips.com/support). When you contact Philips, make sure that the device is nearby and the model number and serial number are available.

No power

- Make sure that the AC power plug of the unit is connected properly.
- Make sure that there is power at the AC outlet.

No sound

- Adjust the volume.

No response from the unit

- Disconnect and reconnect the AC power plug, then turn on the unit again.

Poor radio reception

- Increase the distance between the product and other electrical appliances.
- Fully extend the antenna.

Alarm does not work

- Set the clock/alarm correctly.

Clock/alarm setting erased

- Power has been interrupted or the power plug has been disconnected.
- Reset the clock/alarm.

8 Notice

Any changes or modifications made to this device that are not expressly approved by Gibson Innovations may void the user's authority to operate the equipment.

Disposal of your old product



Your product is designed and manufactured with high quality materials and components, which can be recycled and reused.



This symbol on a product means that the product is covered by European Directive 2012/19/EU. Inform yourself about the local separate collection system for electrical and electronic products. Follow local rules and never dispose of the product with normal household waste. Correct disposal of old products helps prevent negative consequences for the environment and human health.

Environmental information

All unnecessary packaging has been omitted. We have tried to make the packaging easy to separate into three materials: cardboard (box), polystyrene foam (buffer) and polyethylene (bags, protective foam sheet.)

Your system consists of materials which can be recycled and reused if disassembled by a specialized company. Please observe the local regulations regarding the disposal of packaging materials, exhausted batteries and old equipment.



Copyright © 2015 Gibson Innovations Limited. Revised Edition © 2017

This product has been manufactured by, and is sold under the responsibility of Gibson Innovations Ltd., and Gibson Innovations Ltd. is the warrantor in relation to this product. Philips and the Philips Shield Emblem are registered trademarks of Koninklijke Philips N.V. and are used under license.

AJ3232_79_UM_V2.0

