

DVD Micro Theatre

MCD300

使用说明

User manual



PHILIPS

中文 4

English 38

Contents

General Information

Features	40
Supplied accessories	40
Environment information	40
Installation	40
Maintenance	40

Connections

Connecting the speakers	41
Connecting antennas	42
Connecting a TV	42
Connecting the power cord	42
Connecting additional equipment	43

Functional Overview

Controls on the system	44
Remote control	45–46

Getting Started

Step 1: Inserting batteries into the Remote Control	47
Using the Remote Control to operate the Player	
Step 2: Setting up the TV	47–48
Setting up Progressive Scan feature	
To deactivate Progressive manually	
Step 3: Setting language preference	49
Setting the OSD Language	
Setting the Audio, Subtitle and Disc Menu language	

Basic Functions

Switching the system on/off	50
Volume control	50
Sound Control	51
DBB (Dynamic Bass Boost)	
DSC (Digital Sound Control)	
LOUDNESS	
Dimming the display screen	51

Disc Operations

Playable Discs	52
Region Codes	52
Playing discs	53
Using the Disc Menu	53
Selecting and searching	53–54
Selecting a different track/chapter	
Skipping forward/backward	
GOTO	
Different play modes:	
REPEAT, SHUFFLE and REPEAT A-B	54
REPEAT and SHHUFFLE	
REPEAT A-B	
Programming tracks/chapters	55
Display information	56
Playing in slow motion	56
ZOOM	57
AUDIO	57
SUBTITLE	57
Camera angle	57
Playing a title	57
Playing MP3/WMA CD	58
Playing JPEG Picture CD	59
Previewing pictures (JPEG)	
Zooming pictures (JPEG)	
Rotating pictures (JPEG)	
Slide show playback modes (JPEG)	

System Menu Options

Basic Operations	60
General Setup Page	60
TV Display	
Screen Saver	
Audio Setup Page	61~62
SPDIF Setup	
Dolby Digital Setup	
3D Processing	
HDCD	
Post DRC	
Video Setup Page	62
Component	
TV Mode	
Quality	
Preference Page	63
Parental	
Default	
Password Setup Page	64
Password mode	
Password	

Tuner

Tuning to radio stations	65
Storing preset radio stations.....	65
Manual programming	
Auto store: Automatic programming	
Listening to preset radio stations	

Clock/Timer

Setting the clock	66
Setting sleep/wake-up timer	66
Sleep timer setting	
Wake-up timer setting	

Specifications

67

Troubleshooting

68-70

Glossary

71

General Information

Features

Built-in DTS and Dolby® Digital decoder; 2.0-channel amplifier

Additional Component Connections

Lets you connect other audio and audio/visual components to the DVD micro system.

Night Mode

Lets you compress the dynamic range, reducing the difference in loudness between different sounds in Dolby Digital mode.

Parental Control (Rating Level)

Lets you set a ratings level so that your children cannot watch a DVD that has a rating higher than you set.

Sleep/Wake-up Timer

Enables the system to switch on/off automatically at a preset time.

Supplied accessories

- Remote control with two AAA batteries
- MW loop antenna
- FM wire antenna
- 2 loudspeaker boxes including 2 speaker cables
- Composite video cable (yellow)
- Stand
- Quick Start Guide
- User manual

If any item is damaged or missing, contact your retailer or Philips.

Environmental information

All unnecessary packaging has been omitted. We have tried to make the packaging easy to separate into three materials: cardboard (box), polystyrene foam (buffer) and polyethylene (bags, protective foam sheet).

Your system consists of materials which can be recycled and reused if disassembled by a specialised company. Please observe the local regulations regarding the disposal of packaging materials, exhausted batteries and old equipment.

Installation

- Place the player on a flat, hard, and stable surface
- In a cabinet, allow about 10cm (4 inches) of free space all around the player for adequate ventilation.
- Do not expose your player to extreme temperatures or humidity.
- The apparatus shall not be exposed to dripping or splashing and that no objects filled with liquid such as vase shall be placed on the apparatus.
- No naked flame sources, such as lighted candles, shall be placed on the apparatus.
- The ventilation should not be impeded by covering the ventilation openings with items, such as newspapers, table-cloths, curtains, et.

Maintenance

- When a disc becomes dirty, clean it with a cleaning cloth. Wipe the disc from the center out, in a straight line.
- Do not expose the player, batteries or discs to humidity, rain, sand or excessive heat (caused by heating equipment or direct sunlight). Always keep the disc tray closed to avoid dust on the lens.
- Do not use solvents such as benzene, thinner; commercially available cleaners, or anti-static spray intended for colour discs.
- The lens may cloud over when the player is suddenly moved from cold to warm surroundings, making it impossible to play a disc. Leave the player in the warm environment until the moisture evaporates.



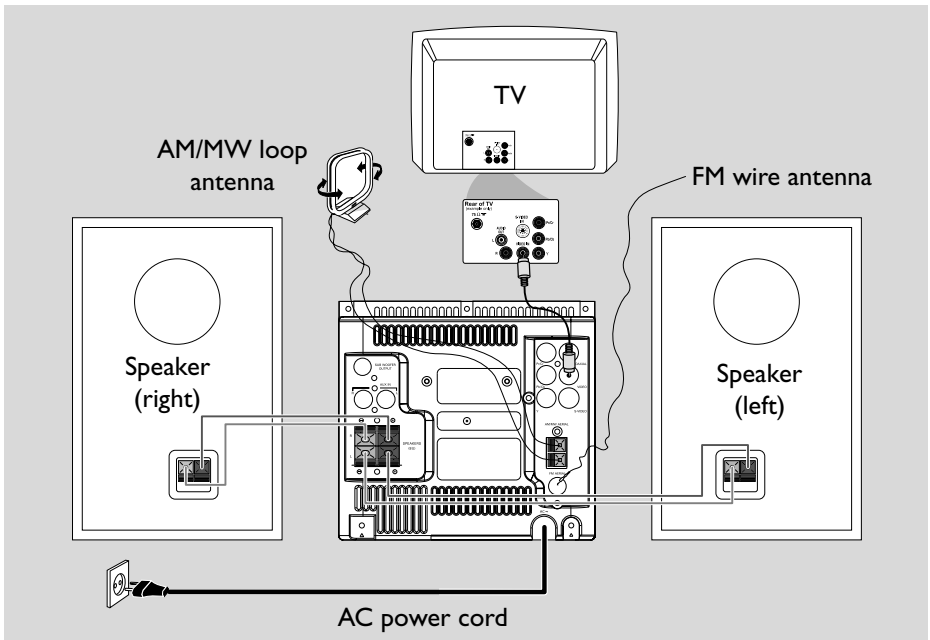

IMPORTANT!

- The type plate is located at the rear of the system.
- Before connecting the AC power cord to the wall outlet, ensure that all other connections have been made.
- Never make or change any connections with the power switched on.

Notes:

- Ensure that the speaker wires are correctly connected. Improper connections may damage the system due to short-circuit.
- For optimal sound performance, use the supplied speakers.
- Do not connect more than one speaker to any one pair of +/- speaker jacks.
- Do not connect speakers with an impedance lower than the speakers supplied. Please refer to the SPECIFICATIONS section of this manual.

Connecting the speakers

Connect the speakers to the SPEAKERS (8Ω) terminals with two speaker wires. Right speaker to “R” and left speaker to “L”, red wire to “+” and silver wire to “-”. Fully insert the stripped portion of the speaker wire into the terminal as shown.

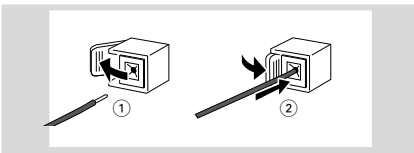

Connections

Connecting antennas

Connect the supplied AM/MW loop antenna and FM antenna to the respective terminals. Adjust the position of the antenna for optimal reception.

AM/MW Indoor Loop Antenna

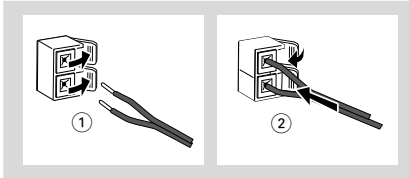

- Position the antenna as far as possible from a TV, VCR or other radiation source.

FM Indoor Antenna

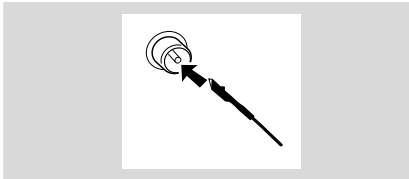

- For better FM stereo reception, connect an outdoor FM antenna to the **FM AERIAL** (FM ANTENNA) terminal.

Connecting a TV

You must connect a TV to your DVD micro system in order to view the DVD/VCD playback.

IMPORTANT!

- There are various ways to connect the system to a TV. You only need to make one of the best connections, depending on the capabilities of your TV system.
- If **COMPONENT** video output jacks or **S-Video** jack is used for video connection, the system's Component setting will need to be set accordingly. Details are shown under "Video Setup Page".

- Connect the **VIDEO** jack to the video input jack on the TV using a video cable (yellow).

OR

Option 1

Connect the **S-VIDEO** output jack to the S-Video input jack on the TV using an S-Video cable (not supplied).

OR

Option 2

Use the component video cables (red/blue/green) to connect the DVD micro system's **COMPONENT** video output jacks to the corresponding component video input jacks (or labeled as **Pr/Cr Pb/CbY** or **YUV**) on the TV.

IMPORTANT!

- The progressive scan video quality is only possible when using **Y Pb Pr** and a progressive scan TV is required. (Proceed to page 47-48 for detailed Progressive Scan setup.)

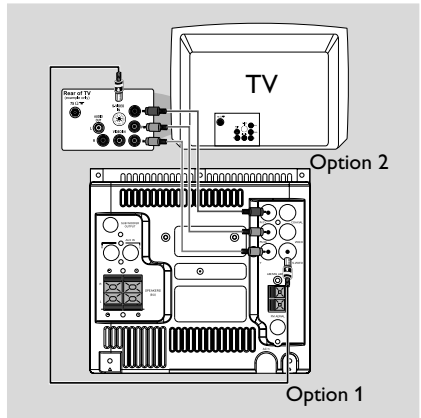

Note:

- To avoid magnetic interference, do not position the front speakers too close to your TV.

Connecting the power cord

After everything is connected properly, plug in the AC power cord to the power outlet.

Never make or change any connection with the power switched on.

Connecting additional equipment

IMPORTANT!

- Some discs are copy-protected. You cannot record the disc through a VCR or digital recording device.
- When making connections, make sure the colour of cables matches the colour of jacks.
- Always refer to the owner's manual of the other equipment for complete connection and usage details.

Active subwoofer (for example)

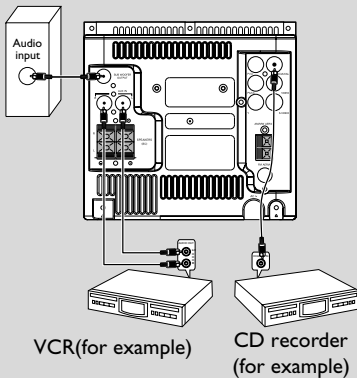

Viewing and listening to the playback of other equipment

- Connect the system's **AUX IN (R/L)** jacks to the AUDIO OUT jacks on the other audio/visual device (such as a TV, VCR, Laser Disc player or cassette deck).
Before starting operation, press **AUX** on the remote repeatedly in order to activate the input source (**AUX**).

Connecting an active subwoofer

- Connect the DVD micro system's **SUB WOOFER OUT** jack to the AUDIO INPUT jack on an active woofer (not supplied).

Recording (digital)

- Connect the system's **COAXIAL** (digital output) jack to the DIGITAL IN jack on a digital recording device (such as DTS-Digital Theatre compatible, with Dolby Digital decoder).
Before starting operation, set SPDIF according to the audio connection. (See "**SPDIF Setup**").

Connecting a digital amplifier

- Connect the **COAXIAL** (digital output) port to the coaxial/optical input jack of a digital amplifier with a coaxial/optical cable (not supplied) for superior digital sound effect.

Functional Overview

English

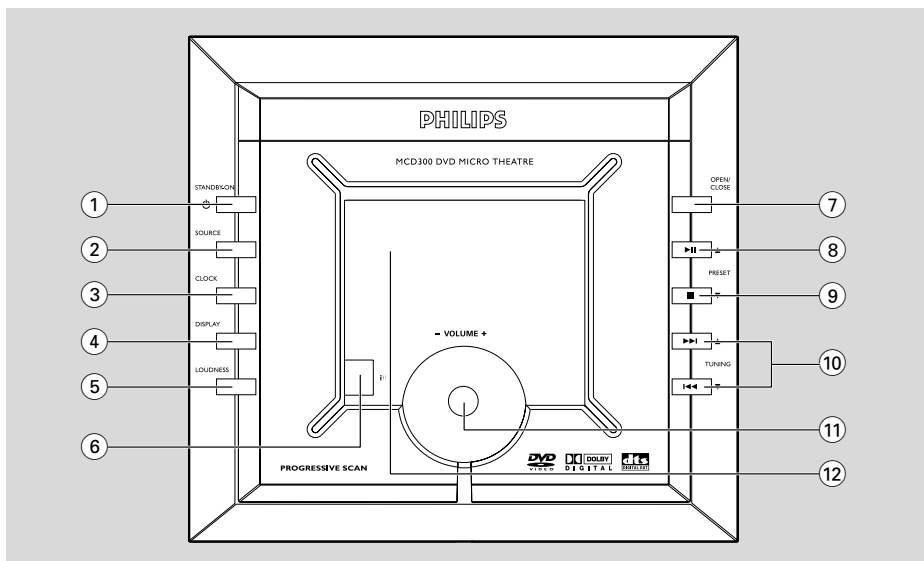

Controls on the system

- ① **STANDBY-ON**

 - switches the system on or to standby mode.

- ② **SOURCE**

 - selects the respective sound source: DVD/AUX/ TUNER (FM and MW).
 - switches the system on.

- ③ **CLOCK**

 - Standby mode**

 - sets the system clock.

 - Playback mode**

 - displays the system clock.

- ④ **DISPLAY**

 - displays information on TV screen during playback.

- ⑤ **LOUDNESS**

 - enables or disables automatic loudness adjustment.

- ⑥ **iR Sensor**

 - point the remote control towards this sensor.

- ⑦ **OPEN•CLOSE**

 - opens or closes the disc door.

- ⑧ **▶ II /PRESET▲**

 - **Disc:** starts or interrupts disc playback
 - **TUNER:** selects a preset radio station upward

- ⑨ **■ /PRESET▼**

 - **Disc:** stops disc playback or erases a program.
 - **TUNER:** selects a preset radio station backward

- ⑩ **◀◀ / ▶▶**

 - Disc press to skip to the previous/ next chapter/title/track.

- TUNING ▲▼**

 - Tuner press to tune to a higher/lower radio frequency.

- ⑪ **VOLUME -/+**

 - adjusts the volume upward/downward.
 - adjusts the hours and minutes in clock/timer setting mode.
 - switches the set waker-up timer ON or OFF.

- ⑫ **Display**

 - shows the current status of the DVD player.

Remote control

- ① **⏻**
 - switches the system on/ off.
- ② **▲**
 - opens or closes the disc compartment door.
- ③ **Numeric Keypad (0-9)**
 - inputs a track/title/chapter number of the disc.
- ④ **PROG**
 - DVD/VCD/CD: enters the program menu.
 - MP3/WMA-CD: adds/deletes a programmed track to/from the program list.
 - **Picture CD**: during playback, to select a slide show mode.
 - **Tuner**: programs preset radio stations.

- ⑤ **GOTO/ST**
 - **Disc**: fast searches in a disc by entering a time, title, chapter or track.
 - **FM**: sets stereo or mono sound mode.
- ⑥ **SYSTEM (disc mode only)**
 - enters or exits the system menu.
- ⑦ **DISC MENU (disc mode only)**
 - DVD/VCD: enters or exits the disc contents menu.
 - VCD2.0: switches the playback control (PBC) mode on or off.
 - MP3/WMA: switches between Album and Filelist.
- ⑧ **▼ / ▲ / ► / ◀**
 - selects an item in a menu.
 - moves an enlarged picture up/down/left/right.
- ⑨ **OK**
 - confirms a selection.
- ⑩ **ZOOM**
 - DVD/VCD/Picture CD: enlarges or reduces a picture or active image on the TV screen.
- ⑪ **MUTE**
 - disables or enables sound output.
- ⑫ **TU +/- (◀◀ / ▶▶)**
 - Tuner**
 - press to tune to a lower/higher radio frequency gradually.
 - press and hold, then release the key to start automatic search for a radio frequency downward/upward.
 - Disc**
 - searches backward/forward in a disc at different speeds.
- ⑬ **VOLUME +/-**
 - adjusts the volume upward/downward.
 - adjusts the hours and minutes in clock/timer setting mode.
 - switches the set wake-up timer ON or OFF.
- ⑭ **CH +/- (◀ / ▶)**
 - **Disc**: skips to the previous/next chapter/title/ track
 - **Tuner**: selects a preset radio station.
- ⑮ **▶ ||**
 - starts or interrupts disc playback.
- ⑯ **■**
 - stops disc playback or erases a program.

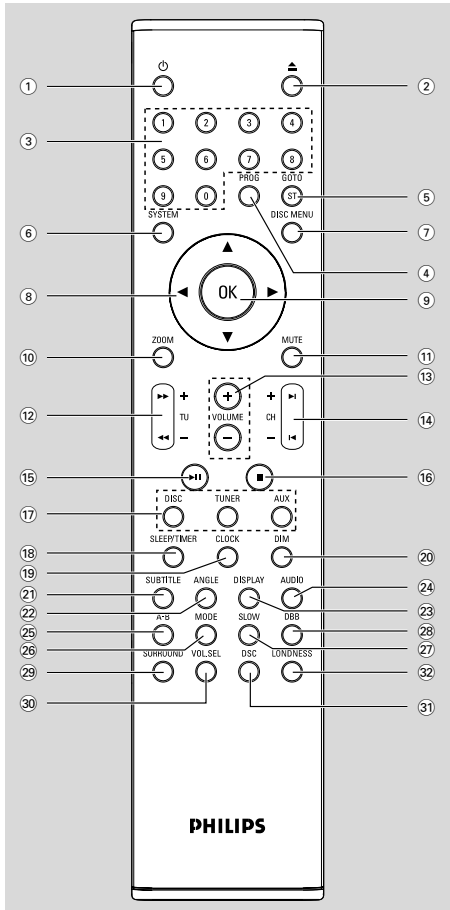

Functional Overview

17 DISC/TUNER/AUX

- selects the respective sound source for DVD/TUNER/AUX.
- exits P-SCAN (progressive scan). (*Only for DISC*)

18 SLEEP/TIMER

Stand-by mode (wake-up timer)

- sets a time for switching on the system automatically.

Power-on mode (sleep timer)

- sets the sleep timer function (auto off).

19 CLOCK

Standby mode

- sets the system clock.

Playback mode

- displays the system clock.

20 DIM

- selects different levels of brightness for the display screen.

21 SUBTITLE

- selects a subtitle language.

22 ANGLE

- selects a DVD camera angle.

23 DISPLAY

- displays information on TV screen during playback

24 AUDIO

for VCD

- sets Stereo, Mono-Left or Mono-Right sound mode.

for DVD

- selects an audio language.

25 A-B

- repeats playback of a specific section on a disc.

26 MODE

- selects various repeat modes or the shuffle play mode for a disc.

27 SLOW

- selects different slow playback modes for a VCD/SVCD/DVD.

28 DBB

- enables or disables bass enhancement.

29 SURROUND (unavailable for this version)

- selects surround (Dolby Digital, DTS-Digital Theatre Systems or VSS-Virtual Surround Sound) or stereo sound effect.

30 VOL.SEL (unavailable for this version)

- selects different speaker modes.

31 DSC

- selects different types of preset sound equalizer settings (CLASSIC, JAZZ, POP or ROCK).

32 LOUDNESS

- enables or disables automatic loudness adjustment.

Step 1: Inserting batteries into the Remote Control

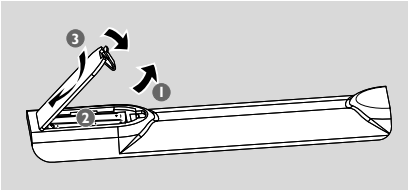

- 1 Open the battery compartment door.
- 2 Insert two AAA batteries following the indications (+/-) inside the compartment.
- 3 Close the cover.

Using the Remote Control to operate the Player

- 1 Aim the Remote Control directly at the remote sensor (IR) on the front panel.
- 2 Do not put any objects between the Remote Control and the DVD Player while operating the DVD Player.

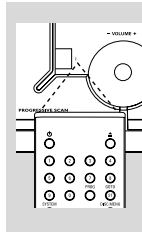

CAUTION!

- Remove batteries if they are exhausted or if the Remote Control is not being used for a long time.
- Do not use old and new or different types of batteries in combination.
- Batteries contain chemical substances, so they should be disposed of properly.

Step 2: Setting up the TV

IMPORTANT!

Make sure you have completed all the necessary connections. (See "Connecting TV").

- 1 Switch the DVD system on and then select DISC source. (See "Switching the system on/off").

- 2 Turn on the TV and set to the correct video-in channel. You should see the blue Philips DVD background screen on the TV.
 - Usually these channels are between the lowest and highest channels and may be called FRONT, AV IN, or VIDEO. See your TV manual for more details.
 - Or, you may go to channel 1 on your TV, then press the Channel up button repeatedly until you see the Video In channel.
 - Or, the TV Remote Control may have a button or switch that chooses different video modes.
 - Or, set the TV to channel 3 or 4 if you are using an RF modulator.

Setting up Progressive Scan feature (for Progressive Scan TV only)

The progressive scan display twice the number of frames per seconds than interlaced scanning (ordinary normal TV system). With nearly double the number of lines, progressive scan offers higher picture resolution and quality.

IMPORTANT!

Before enabling the progressive scan feature, you must ensure:

- 1) Your TV can accept progressive signals, a progressive scan TV is required.
- 2) You have connected the DVD player to your TV using Y Pb Pr (see page 42.)

- 1 Turn on your TV.
- 2 Turn off your TV progressive scan mode or turn on interlaced mode (refer to your TV user manual).
- 3 Press **STANDBY-ON** (⏻) (⏻ on the remote) to turn on the DVD player.
- 4 Select the correct Video Input channel.
 - The DVD background screen appears on the TV.
- 5 Press **SYSTEM** on the remote control.

Getting Started

- 6 Press ◀ ▶ repeatedly to select "**Video Setup Page**".
- 7 Select "**TV MODE**" to "**P-SCAN**", then **OK** to confirm.
→ The instruction menu appears on the TV.

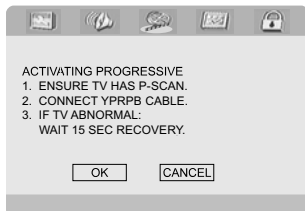

- 8 Press ◀ ▶ to highlight OK in the menu and press **OK** to confirm.
There will be a distorted picture on your TV at this state until you turn on the progressive scan mode on your TV.
- 9 Turn on your TV progressive scan mode (refer to your TV user manual).
→ The below menu appears on the TV.

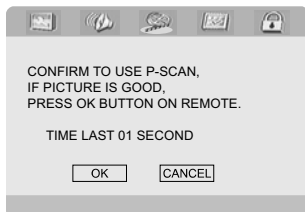

- 10 Press ◀ ▶ to highlight OK in the menu and press **OK** to confirm.
→ The setup is complete now and you can start enjoying the high quality picture.

To deactivate Progressive manually

- **When the distorted sign still appears on the TV**, it may be due to the connected TV does not accept progressive signals, and progressive is set by mistake. You must reset the unit to interlace format.

- 1 Turn off your TV progressive scan mode or turn on to interlaced mode (refer to your TV user manual).
- 2 Press **SYSTEM** on the remote to exit the system menu and then **DISC** to exit progressive scan.
→ The DVD blue background screen will appear on the TV.

Step 3: Setting language preference

You can select your own preferred language settings. This DVD system will automatically switch to the selected language whenever you load a disc. If the language selected is not available on the disc, the disc's default language will be used instead. The OSD language in the system menu will remain once selected.

Setting the OSD Language

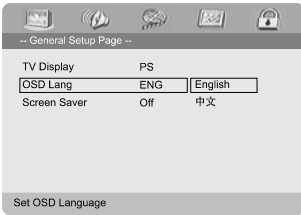

- 1 In the stop mode, press **SYSTEM** on the remote control.
→ The system menu pops up on the TV screen.
- 2 Press ◀▶ to select "**General Setup Page**".
- 3 Use ◀▶ ▲ ▼ on the remote to navigate in the menu.
Move to "**OSD Lang**" and press ▶.
- 4 Select a language and press **OK**.

To exit the menu

- Press **SYSTEM** on the remote control again.

Setting the Audio, Subtitle and Disc Menu language

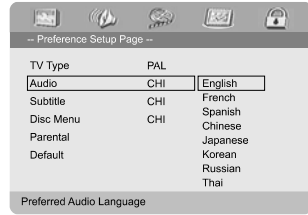

- 1 In the stop mode, press **SYSTEM** on the remote control.
- 2 Press ◀▶ to select "PREFERENCE PAGE".
- 3 Press ▲ ▼ to highlight the following in the Preference Page.
 - "Audio" (disc's soundtrack)
 - "Subtitle" (disc's subtitles)
 - "Disc Menu" (disc's menu)
- 4 Enter its submenu by pressing ▶.
- 5 Select a language and press **OK**.
- 6 Repeat steps 3~5 for other language settings.

To exit the menu

- Press **SYSTEM** on the remote control again.

If you choose **OTHERS** in Audio, Subtitle or Disc Menu,

- 1 Press ▲ ▼ to highlight "OTHERS".
- 2 Press **OK**.
- 3 When you are asked to enter a language code, input a language code by using the **Numeric Keypad (0-9)**.
- 4 Press **OK** to confirm.

Basic Operations

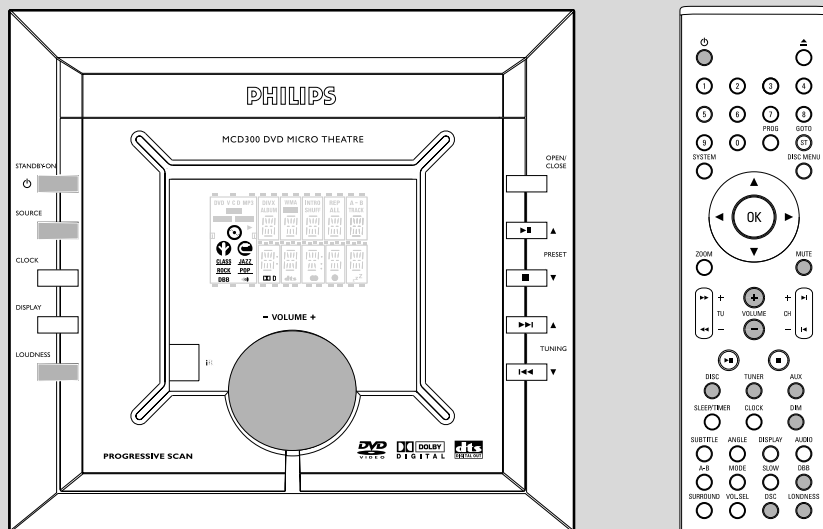

IMPORTANT!

- Before you operate the system, complete the connection procedures.
- When the system is switched to Standby mode, it is still consuming power. To disconnect the system from the power supply completely, remove the AC power plug from the wall socket.

Switching the system on/off

- Press **STANDBY ON** (⏻ on the remote).
→ "HELLO" is displayed briefly. The system will switch to the last selected source.
- Press **DISC**, **TUNER** or **AUX** on the remote.
→ The system will switch to the selected source.

To switch the system to standby mode

- Press **STANDBY ON** (⏻ on the remote).
→ The display shows "BYE BYE" briefly, then --:--:-- (if you haven't set time) or the set time. (See Setting the clock' on page 66.)

Helpful hints:

- The interactive sound settings, last selected source and tuner presets will be retained in the player's memory.

Volume control

Turn **VOLUME (+/-)** clockwise or anticlockwise (or press **VOLUME +/-** on the remote) to increase or decrease the volume level.

→ The display shows "VOL" and a volume value from "1" to "30" ("MIN" or "MAX" is displayed when the volume level is adjusted to the lowest or highest).

To listen through the headphone

- Connect the headphone plug to the  socket at the top of the system.
→ The speakers will be muted.

IMPORTANT!

- Adjust the volume to a moderate level before you plug in the headphones.

To switch off the volume temporarily

- Press **MUTE** on the remote.
→ Playback will continue without sound and "MUTE" flashes.
- To activate sound reproduction, you can:
 - press **MUTE** again;
 - adjust the volume controls;
 - change source.

Sound Control

DBB, DSC and LOUDNESS sound features cannot be activated at the same time.

DBB (Dynamic Bass Boost)

DBB enhances the bass response.

- Press **DBB** on the remote to enable/disable DBB feature.
→ If the DBB is activated,  is shown.

Helpful hints:

– *Some discs might be recorded in high modulation, which causes a distortion at high volume. If this occurs, switch off DBB or reduce the volume.*

DSC (Digital Sound Control)

DSC provides a different type of preset sound equalizer setting.

- Press **DSC** on the remote repeatedly to select: CLASSIC, JAZZ, POP or ROCK.
→ The display shows the selected sound setting.

LOUDNESS

LOUDNESS feature enables the system to automatically increase the treble and bass sound effect at low volume (the higher the volume, the lower the treble and bass increase).

- Press **LOUDNESS** on the remote to enable or disable LOUDNESS feature.
→  icon appears/disappears after this feature is enabled/disabled.

Dimming the display screen

- Press **DIM** repeatedly to select different levels of brightness for the display screen.

Playing discs

- 1 Make sure that the system is properly connected to your TV (see **Connecting a TV** on page 42), and your TV is turned on and set to video-in channel (**Setting up the TV** on page 47).
- 2 Press **SOURCE** on the system once or more to select DVD mode (or **DISC** on the remote control).
→ You should see the blue Philips DVD background screen on the TV.
- 3 Press **OPEN/CLOSE** (or ▲ on the remote control) to open the disc tray.
- 4 Insert a disc with the print side facing up and press **OPEN/CLOSE** (or ▲ on the remote control) to close the disc tray.
- 5 Playback will start automatically (depending on the disc type).
→ If a disc menu appears on the TV, see "**Using the Disc Menu**".
→ If the disc is locked by parental control, you must enter your four-digit password. (See "**Password Setup Page**").

To interrupt playback

- Press ►||.
- The playtime on the display flashes.
- To resume playback, press ►|| again.

To stop playback

- Press ■.

Using the Disc Menu

Depending on the disc, a menu may appear on the TV screen once you load the disc.

To select a playback feature or item

- Use ◀▶ ▲ ▼ and **OK** or **Numeric Keypad (0-9)** on the remote control, then press ►|| to start playback.

For VCD with Playback Control (PBC) feature (version 2.0 only)

PBC playback allows you to play Video CDs interactively, following the menu on the display, such as allowing you to select favourite songs.

- To switch PBC on or off, press **DISC MENU** during playback.
→ If PBC was ON, it will switch to OFF and continue playback.

→ If PBC was OFF, it will switch to ON and return to menu screen.

Selecting and searching

Selecting a different track/chapter

For DVD/VCD/CD/MP3:

- During playback, briefly press ◀◀ / ▶▶ (or on the remote control, **CH** ◀ / ▶) once or more until your desired track/chapter number appears.
Or,
use the **Numeric Keypad (0-9)** on the remote control to input your track/chapter number using two digits, e.g.
Track/chapter 2: Press 0 and then, 2
Track/chapter 10: Press 1 and then, 0
(For **MP3**, you may directly input your desired track number in one, two or three digits.)
→ After selecting, playback will automatically start from the selected chapter/track.

Helpful hints:

– Some VCDs have a single track, so track selecting or an invalid input value for the current disc will be ignored.

Skipping forward/backward

For DVD/VCD/CD/MP3:

- 1 During playback, press **TU** ◀◀ / ▶▶ on the remote control repeatedly to select fast search speed (x2, x4, x8, x16 or x32 in backward or forward playback).
→ The disc plays at a high speed with no sound.
- 2 When you recognize the passage you want, press ►|| or **OK**
→ Normal playback resumes.

Helpful hints:

– For **MP3**, skipping forward/backward is available only within the same track.

Disc Operations

GOTO

- 1 During playback, press **GOTO/ST** once or more on the remote control.
→ TV screen shows various search bars in the sequence as follows:

For DVDs:

Title 04/04 **Chapter** / 24

(used to select chapter number; or title file field using ◀ ▶ on the remote control)

Title 04/04 **Time** : :

(used to select playtime within the current title)

Chapter 05/24 **Time** : :

(used to select playtime within the current chapter)

For VCDs/CDs:

Disc Go To: - : - :

(used to select playtime within the entire disc)

Track Go To: - : - :

(used to select playtime within the current track)

Select Track: - / 1 2

(used to select a track number within the entire disc)

For MP3:

- - - / 1 9 6

(used to select a file number within the entire disc)

- - : - -

(used to select playtime within the current file)

- 2 Use the **Numeric Keypad** (0-9) on the remote control to input your title/track/chapter number or playtime.
→ After selecting, playback will automatically start from the selected chapter/track or playtime.

Helpful hints:

– An invalid input value for the current disc will be ingored.

Different play modes: REPEAT, SHUFFLE and REPEAT A-B

REPEAT and SHUFFLE

- During playback, press repeatedly **MODE** on the remote control to choose desired play modes.
→ TV screen shows the play modes in the sequence as follows:

DVDs

↺ **Chapter:** Repeats the current chapter

↺ **Title:** Repeats the current title

↺ **All:** Repeats the entire disc

Shuffle: Repeats the titles and chapters of the entire disc in a random order

VCDs/CDs

↺ **Track:** Repeats the current track

↺ **All:** Plays all the tracks repeatedly

Shuffle: Repeats the tracks of the entire disc in a random order

MP3/JPEG:

Repeat One: Plays an MP3/JPEG file repeatedly

Repeat All: Plays all files repeatedly

Shuffle: Plays all files in a random order

Off: Switches off shuffle play

- To return to normal playback, press **MODE** repeatedly until the REPEAT/SHUFFLE play modes are no longer displayed.

Helpful hints:

– The display on the system shows **REP** when the repeat of the current title/chapter/track is selected, or shows **REP ALL** when the repeat of the entire disc is selected, or shows **SHUFF** when shuffle play is selected.

Repeat A-B

For DVD/VCD/CD/MP3/WMA:

- 1 Press **A-B** at your chosen starting point.
- 2 Press **A-B** again at your chosen end point.
→ The section will now repeat continuously.
- 3 To exit the sequence, press **A-B** again.

Programming tracks/chapters

For DVDs/VCDs/CDs

You can select and program up to 20 desired tracks/ chapters for playback in the desired sequence. If you like, store any track/chapter/title more than once.

- 1 Press **PROG** on the remote control to activate programming mode.
→ On the TV screen, the program pop-up appears, and the first program position is highlighted for you to enter the desired track/chapter/title numbers.

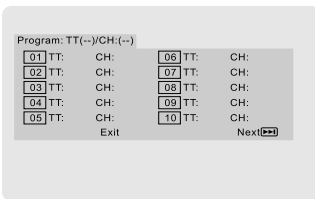

(DVD program for example)

- 2 Use the **Numeric Keypad** (0-9) on the remote control to enter your desired track/ chapter/ title number using 2 digits. E.g. Track/chapter 7, press 0 and then, 7.

 - Programming is possible only in the sequence starting from 01.
 - For **DVDs**, you need to input title number (TT), then input chapter number (CH).
 - To access another 10 program sequence in the next page, use ◀▶▲▼ on the remote control to select **Next**, then press **OK**.
→ After title/chapter/track number is correctly entered in a program position, the next program sequence will be highlighted for you to program.

- 3 To start playback, use ◀▶▲▼ on the remote control to select **Start**, then press **OK** on the remote control.
→ The display on the system shows **PROG**.

Erasing program

- To exit program menu without programming, navigate to select **Exit**, then press **OK**, or simply press **PROG**.

- During playback of program, press **PROG** to pop up the program menu to select **Stop**, then press **OK**.
- When playback of program comes to an end, the playback will come to the stop position and the program will be erased.

To reivev program

During program playback, press **PROG** on the remote control.

→ The program list is displayed on the TV screen.

- To exit the program list, use ◀▶ on the remote control to select **Exit**, then press **OK**.

For MP3/JPEG

- 1 Use ◀▶▲▼ on the remote control to highlight desired MP3 file displayed on the TV screen.

 - You may press **DISC MENU** once or more to switch between filelist and album(folder) display. Press ▶ to access the MP3 files in one folder.

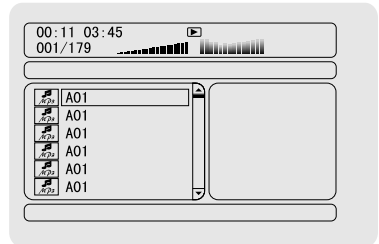

- 2 Press **PROG** on the remote control to add a MP3 file to the program list.
→ "**Add To Program List**" is displayed briefly at the bottom of the TV screen.

To playback program

- 1 Press **DISC MENU** once or more until program list is displayed on the TV screen.
→ "**Program list**" is displayed briefly at the bottom of the TV screen.
- 2 Press **OK** when a program file is highlighted.

Disc Operations

To erase a program

- In the program list, use ◀ ▶ ▲ ▼ on the remote control to highlight the a program you want to delete, then press **PROG** to delete.

Display information

During playback, press **DISPLAY** on the remote control once or more to display the disc information on the TV screen.

For **DVDs**:

- By pressing **DISPLAY**, TV screen shows current/total title number and current/total chapter (of the current title) number:

TT 04/04 CH 16/24 0:37:46

- By pressing **DISPLAY** repeatedly, TV screen also shows time option in the sequence as follows:

Title Elapsed - elapsed playback time of current title

Title Remain - remaining time of current title

Chapter Elapsed - elapsed playback time of current chapter

Chapter Remain - remaining time of current chapter

Display Off - turns off the display information

For **VCDs/CDs**

- By pressing **DISPLAY**, TV screen shows current/total track number:

Track 01/12 01:37

- By pressing **DISPLAY** repeatedly, TV screen also shows time option in the sequence as follows:

Single Elapsed - elapsed playback time of current track

Single Remain - remaining time of current track

Total Elapsed - elapsed playback time of disc.

Total Remain - remaining playback time of disc

Display Off - turns off the display information

Playing in slow motion

For **DVDs/VCDs**:

- 1 Press **SLOW** repeatedly on the remote control during playback to select the desired speed: 1/2, 1/4, 1/8 or 1/16 (in forward or backward playback)
 - Sound will be muted.
 - Slow backward is not possible on VCDs.
- 2 To return to normal speed, press ▶|| (or press **SLOW** repeatedly until the speed number disappears).

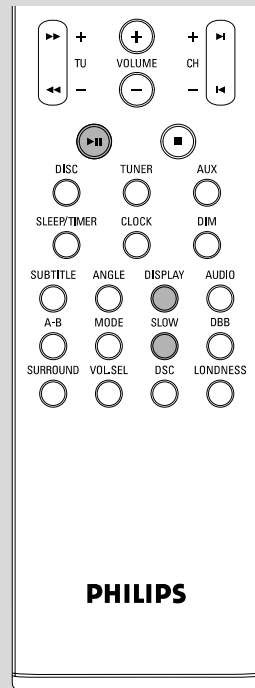

ZOOM

For **DVDs/VCDs/JPEG**

Zooming allows you to enlarge or reduce the video/ JPEG image during playback.

- Press **ZOOM** repeatedly to zoom in and out on the playback video image.
→ Image size enlarges at 2X, 3 X, 4 X or reduces at 1/2, 1/3, 1/4 .
- To return to normal playback, press **ZOOM** repeatedly until the numbers disappear.

Helpful hints:

– When zooming in, you may use ◀ ▶ ▲ ▼ on the remote control to pan a picture across your TV screen in pause position or during playback.

AUDIO

For **DVDs**

- On the remote control, press **AUDIO** repeatedly to select the desired language for sound track.
→ The feature is disc dependant.

For **VCDs**

- Press **AUDIO** repeatedly to select the audio channel for sound output displayed on the TV screen.

Mono Left, Mono Right and Stereo

SUBTITLE (DVD only)

- Press repeatedly **SUBTITLE** on the remote control to select different subtitle languages.
→ The feature is disc dependant.

Camera Angle (DVD only)

- Press **ANGLE** repeatedly to select different desired angle, allowing you to view pictures from different recorded camera angles.
→ The feature is disc dependant.

Playing a Title (DVD only)

- 1 During playback, press **DISC MENU** on the remote control.
→ The disc title menu appears on the TV screen.
- 2 Use ◀ ▶ ▲ ▼ or **Numeric Keypad (0-9)** to select a play option.
- 3 Press **OK** to confirm.

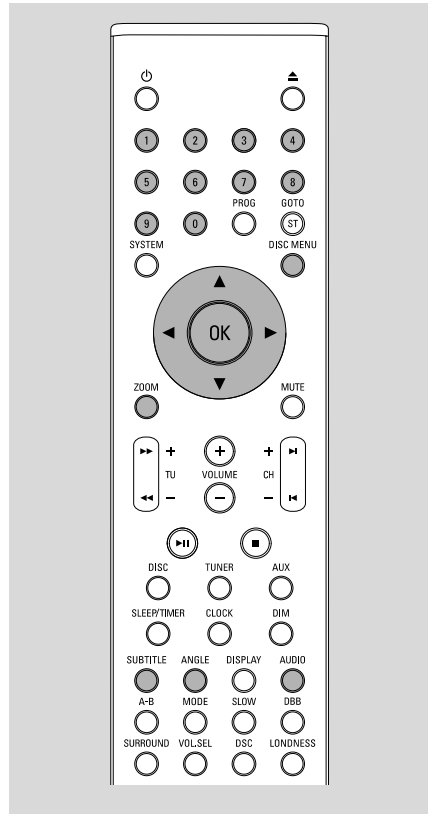

Disc Operations

Playing MP3/WMA CD

IMPORTANT!

– Make sure that the system is properly connected to your TV (see Connecting a TV on page 42), and your TV is turned on and set to video-in channel (Setting up the TV on page 47).

– For DRM protected WMA files, use windows Media Player 10 (or later) for CD burning/conversion. Visit www.microsoft.com for details about Windows Media Player and WM DRM (Windows Media Digital Rights Management).

- 1 Load an MP3/WMA disc.
→ The file list of the entire disc is displayed on the TV screen.

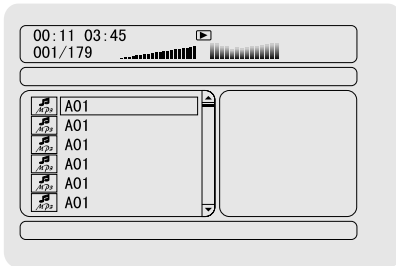

- 2 Use **▲ ▼** or **Numeric Keypad (0-9)** on the remote control to highlight a file.
- 3 To playback the highlighted file, press **OK**.
- Press **DISC MENU** to view the album (folder) display of the entire disc. To open the selected folder; press **▶** or **OK**. To exit the opened folder; press **◀**.
- To switch back to the file list display, press **DISC MENU** once or more..

To interrupt playback

- Press **▶||**.
→ The playtime on the display flashes.
- To resume playback, press **▶||** again.

To stop playback

- Press **■**.

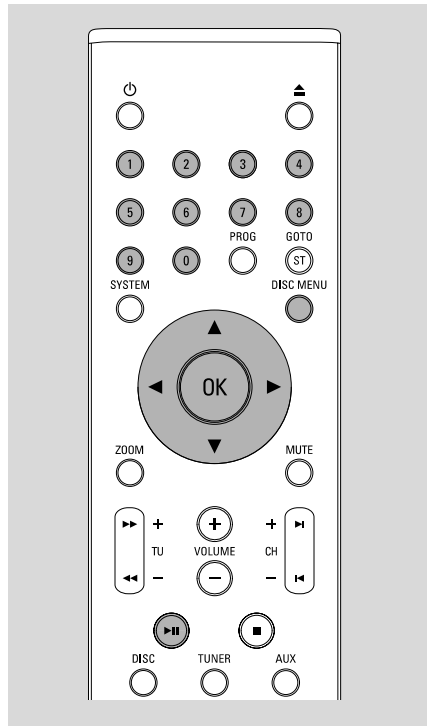

Playing JPEG Picture CD

IMPORTANT!

– **Make sure that the system is properly connected to your TV (see Connecting a TV on page 42), and your TV is turned on and set to video-in channel (Setting up the TV on page 47).**

- 1 Load a JPEG Picture disc.
- After several seconds of disc loading, pictures will be automatically slide showed on the TV screen at an interval of 4-5 seconds.
 - Slide show will continue until all the pictures are slide showed.
 - The display on the system shows **JPEG**, and the number of pictures already slide showed.

To exit slide showing

- Press **DISC MENU**.
 - The file list appears on the TV screen.
- Or,**
- Press **■**.
 - 12 thumbnail pictures appear on the TV screen.

Previewing pictures (JPEG)

JPEG pictures can be previewed by using either of the following ways.

- 1 During slide show, press **DISC MENU**.
 - The file list appears on the TV screen.
- 2 Use **▲ ▼** or **Numeric Keypad (0-9)** on the remote control to highlight a file.
 - The selected picture will be previewed in thumbnail on the TV screen.
- To slide show, press **OK** when a picture is highlighted.
 - Slide show will start from the selected picture.
- Or,**
- 1 During slide showing, press **■**.
 - 12 thumbnail pictures appear on the TV screen.

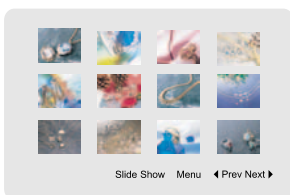

- 2 Use **◀ ▶ ▲ ▼** to highlight **◀Prev** or **Next▶**, then press **OK** to go to the previous or next screen.
- To slide show, press **OK** when a picture or **Slide Show** is highlighted by using **◀ ▶ ▲ ▼**.

Zooming pictures (JPEG)

- During slideshow, press **ZOOM** repeatedly to display a picture at enlarged sizes (125%, 150% or 200%) or reduced sizes (75% or 50%).
- Use **◀ ▶ ▲ ▼** to pan across the enlarged picture.
 - Slide show is paused at a zoomed picture, and slide show will resume when the zoomed picture is adjusted to the normal size.

Rotating pictures (JPEG)

- During slideshow, press **◀ ▶ ▲ ▼** to rotate a picture on the TV screen.
 - ▲: flip a picture vertically
 - ▼: flip a picture horizontally
 - ◀: rotate a picture anti-clokwise
 - ▶: rotate a picture clokwise

Slide show playback modes (JPEG)

- During slideshow, press **PROG** repeatedly to select different slide-show playback modes in the sequence as follows:
 - Mode 0: None
 - Mode 1: Wipe Top
 - Mode 2: Wipe Bottom
 - Mode 3: Wipe Left
 - Mode 4: Wipe Right
 - Mode 5: Diagonal Wipe Left Top
 - Mode 6: Diagonal Wipe Right Top
 - Mode 7: Diagonal Wipe Left Bottom
 - Mode 8: Diagonal Wipe Right Bottom
 - Mode 9: Extend From Center H
 - Mode 10: Extend From Center V
 - Mode 11: Compress To Center H
 - Mode 12: Compress To Center V
 - Mode 13: Window H
 - Mode 14: Window V
 - Mode 15: Wipe From Edge To Center
 - Mode 16: Move In From Top

System Menu Options

Basic operations

- 1 Press **SYSTEM** to enter the Setup Menu.
- 2 Press ◀ ▶ to select the desired page:
General Setup Page, Audio Setup Page, Video Setup page and **Password Setup page**.
- 3 Press ▲ ▼ to highlight an option.
- 4 Enter its submenu by pressing ▶ or **OK**.
- 5 Move the cursor by pressing ▲ ▼ to highlight the selected item.
→ In cases of value setting, press ◀ ▶ to adjust values.
- 6 Press **OK** to confirm.

To return to the upper-level menu

- Press ◀ or **OK** (in cases of value adjustment).

To exit the menu

- Press **SYSTEM** again.
→ The settings will be stored in the player's memory even if the player is switched off.

Note:

– Some of the features in the System Menu Options are described in "Getting Started".

General Setup Page

The options included in General Setup page are: "TV Display", "OSD Lang", and "Screen Saver"

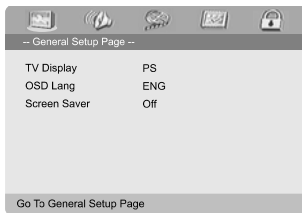

TV Display (default: Normal/PS)

Set the aspect ratio of the DVD Player according to the TV you have connected.

→ **Normal/PS** (panscan): If you have a normal TV and want both sides of the picture to be trimmed or formatted to fit your TV screen.



→ **Normal/LB** (letterbox): If you have a normal TV. In this case, a wide picture with black bands on the upper and lower portions of the TV screen will be displayed.



→ **Wide**: If you have a wide-screen TV.



Screen Saver (default: On)

This function is used to turn the screen saver on or off.

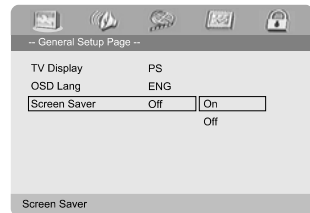

→ **On**: In STOP, PAUSE or No DISC mode, if no actions are performed about 3 minutes, the screen saver will be activated.

→ **Off**: Screen saver is disabled.

Audio Setup Page

The options included in Audio Setup page are: "SPDIF Setup", "Dolby Digital Setup", "3D Processing", "HDCD" and "Post DRC".

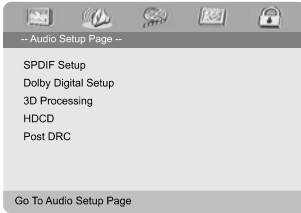

SPDIF Setup (default: SPDIF/RAW)

The options included in SPDIF (Sony/Phillips Digital Interface Format) Setup Page are: "SPDIF Off", "SPDIF/Raw" and "SPDIF/PCM".

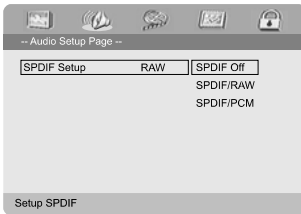

- **SPDIF Off:** Turns off the SPDIF output.
- **SPDIF/Raw:** If you have connected your DIGITAL OUT (COAXIAL or OPTICAL) to a multi-channel decoder/receiver.
- **SPDIF/PCM:** Only if your receiver is not capable of decoding multi-channel audio.

Dolby Digital Setup

The options included in Dolby Digital Setup are: "Dual Mono" and "Dynamic".

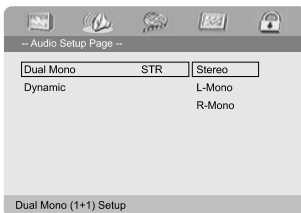

Dual Mono (default: stereo)

Select the setting that matches the number of speakers you have connected.

- **Stereo:** Left mono sound will send output signals to Left speaker and Right mono sound will send output signals to Right speaker.
- **L-Mono:** Left mono sound will send output signals to Left speaker and Right speaker.
- **R-Mono:** Right mono sound will send output signals to Left speaker and Right speaker.

Dynamic (default: Off)

Optimise the dynamic sound output. High volume outputs are softened, enabling you to watch your favourite movie without disturbing others.

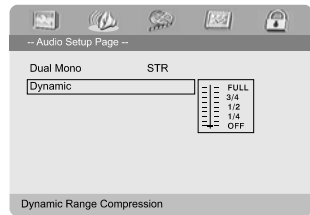

- The levels for dynamic selection: **FULL, 3/4, 1/2, 1/4** and **OFF**.

Note:

- *DTS surround audio output is not available in this DVD player.*

3D Processing

The option included in 3D Processing is: "Reverb Mode".

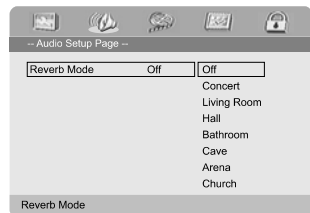

Reverb Mode (default: Off)

Reverb mode provides a virtual surround sound experience using just two speakers.

- **Off, Concert, Living Room, Hall, Bathroom, Cave, Arena** and **Church**.

System Menu Options

HDCD

The option included in HDCD (High Definition Compatible Digital) is: "Filter".

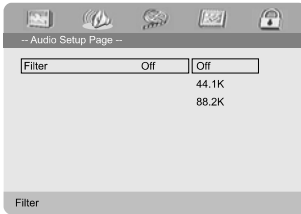

Filter (default: Off)

Sets the audio output cutoff frequency point when playing an HDCD disc.

→ **Off**, **44.1K** and **88.2K**.

Post DRC (default: On)

Switches on/off analogue sound dynamic range compression.

→ **On**: Audio with fully compressed dynamic range.

→ **Off**: Audio with uncompressed dynamic range.

Video Setup Page

The options included in Video Setup page are: "Component", "TV Mode" and "Quality".

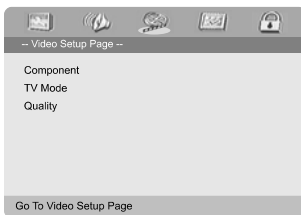

Component

Sets the video output according to your video connection. This setting is not required if you are using the **VIDEO** jack (yellow) to connect the DVD micro system to your TV.

→ **Pr/Cr Pb/CbY**: Select this if you have connected the DVD micro system to your TV using Component video jacks.

→ **S-Video**: Select this if you have connected the DVD micro system to your TV using S-Video jack.

TV Mode (default: Interface)

Selects interlace or P-SCAN video output mode when **Pr/Cr Pb/CbY** is selected.

→ **P-SCAN** and **Interlace**.

In the progressive scan mode, you can enjoy the high quality picture with less flickers. It only works when you have connected the DVD player's Y Pb Pr jacks to your TV that supports the progressive video input. Otherwise, a distorted picture will appear on the TV. For proper progressive scan set up, see page 43-44.

Quality

This menu helps you to set the video quality.

- 1 Press **▲ ▼** to highlight "Quality".
- 2 Press **▶** or **OK** to enter Video Quality Setup.

The options included in Video Quality Setup page are: "Sharpness", "Brightness", "Contrast", "Gamma", "Hue", "Saturation" and "Luma Delay".

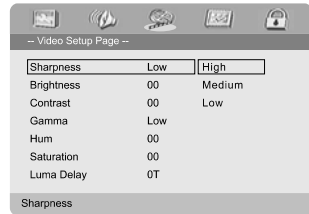

Sharpness

Adjusts the sharpness level.

→ **High**, **Medium** and **Low**.

Brightness

Adjusts the brightness level. Range: -20+20.

Contrast

Adjusts the contrast level. Range: -16+16.

Gamma

Adjusts the gamma level.

→ **High**, **Medium**, **Low** and **None**.

Hue

Adjusts the hue level. Range: -9+9.

Saturation

Adjusts the saturation level. Range: -9+9.

Luma Delay

Adjusts the luma delay.

→ **0T** and **1T**.

Preference Page

The options included in Preference page are: "TV Type", "Audio", "Subtitle", "Disc Menu", "Parental" and "Default".

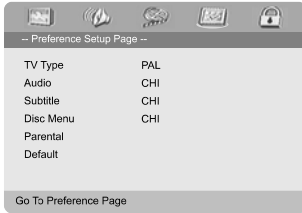

Note:

– Preference features can be selected only during "No Disc" condition or full STOP mode.

Parental

Some DVDs may have a parental level assigned to the complete disc or to certain scenes on the disc. This feature lets you set a playback limitation level.

The rating levels are from 1 to 8 and are country dependent. You can prohibit the playing of certain discs that are not suitable for your children or have certain discs played with alternative scenes.

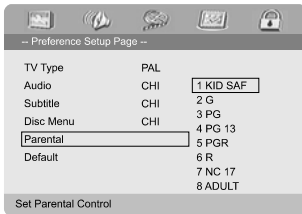

- VCD, SVCD and CD have no level indication, so parental control function has no effect on those kinds of discs. This applies to most illegal DVD discs.

- 1 Press ▲ ▼ to highlight "Parental".
- 2 Enter its submenu by pressing ►.

- 3 Use ▲ ▼ to highlight a rating level for the disc inserted.
→ DVDs that are rated above the level you selected will not play unless you enter your four-digit password and choose a higher level rating.

Note:

– Some DVDs are not encoded with a rating though the movie rating may be printed on the Disc cover. The rating level feature does not work for such Discs.

Rating explanations

1 KID SAF

– Kids material; recommended especially for children and viewers of all ages.

2 G

– General Audience; recommended as acceptable for viewers of all ages.

3 PG

– Parental Guidance suggested.

4 PG 13

– Material is unsuitable for children under age 13.

5-6 PGR, R

– Parental Guidance - Restricted; recommended that parents restrict children under 17 from viewing or allow to view only when supervised by a parent or adult guardian.

7 NC-17

– No children under age 17; not recommended viewing for children under age 17.

8 Adult

– Mature materials; should be viewed only by adults due to graphic sexual material, violence or language.

Default

Setting the "Default" function will reset all options and your personal settings to the factory defaults and all your personal settings will be erased.

Caution!

– When this function is activated, all settings will be reset to factory defaults.

System Menu Options

Password Setup Page

The options included in Password Setup page are: "Password Mode" and "Password".



Password Mode (default: On)

This feature is used to enable/disable password protection by selecting "ON"/"OFF".

Password

Enter your four digit password when a hint is displayed on the screen. The default password is 1234.

- 1 Press **▲▼** to highlight "Password".
- 2 Enter its submenu by pressing **▶**.
- 3 Press **OK** to open the page for inputting a new password.



- 4 Enter the existing 4-digit code.
- 5 Enter the new 4-digit code.
- 6 Enter the new 4-digit code a second time to confirm.
→ The new 4-digit code will take effect.
- 7 Press **OK** to exit.

Notes:

- If the password has been changed, the parental and disc lock code will also be changed.
- The default password (1234) is always active even the password has been changed.

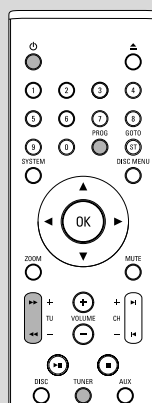
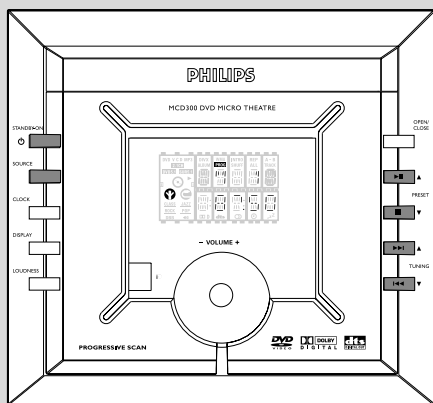

Tuning to radio stations

- 1 Press **STANDBY-ON** (or on the remote) to switch on the last selected source.
- 2 Press repeatedly **SOURCE** (or **TUNER** on the remote) until **FM** or **MW** is displayed.
- 3 Press and hold **TUNING** / **TU +/-** / **◀▶** on the remote until the frequency in the display starts changing.
→ Display shows **SEARC** during automatic tuning.
→ After the system tunes to a station of sufficient reception, display shows its frequency .
- To tune to a weak station, press briefly and repeatedly **TUNING** / **TU +/-** / **◀▶** on the remote until an optimal reception is found.
- 4 Repeat Step 3 if necessary until you find the desired radio station.

Storing preset radio stations

You can preset up to 40 stations (20 in each band) regardless of the reception.

Manual programming

- 1 Tune to your desired radio station (refer to "Tuning to radio stations").
- 2 Press **PROG** on the remote.
→ "PROG" icon flashes.
- 3 Press **PRESET** / **CH +/-** (/) on the remote to select the desired preset number.

- 4 Press **PROG** on the remote again to store the radio station.
→ "PROG" disappears on the display.
- Repeat steps 1-4 to store other radio stations.

Helpful hints:

– You can erase a preset station by storing another frequency in its place.

Autostore: automatic programming

Autostore automatically starts programming radio stations from preset 1. Any previous presets e.g. manually programmed will be erased.

- In tuner mode (FM or AM), press and hold **PROG** until **AUTO** appears.
→ During automatic programming, display shows **AUTO** and flashing **PROG**.
→ Available stations are programmed (20FM or 20 AM).
→ After all stations are stored, the first autostore preset station automatically plays.

Listening to preset radio stations

- In tuner mode, press **PRESET** / **CH +/-** (/) on the remote to select the desired preset number.
→ The preset number, radio frequency, and waveband are displayed.

Clock/Timer

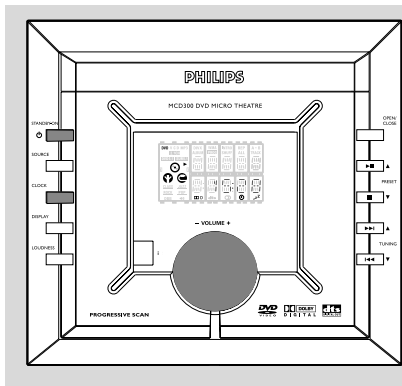

Setting the clock

- 1 In Standby mode, press and hold **CLOCK** on the remote until the time flashes on the display.
→ "SET CLOCK" is displayed briefly. Then, the hour digits flash on the display screen.
- 2 Turn **VOLUME +/-** clockwise or anticlockwise or press **VOLUME +/-** on the remote to set the hours.
- 3 Press **CLOCK** to confirm.
→ The minute digits flash on the display screen.
- 4 Turn **VOLUME +/-** clockwise or anticlockwise or press **VOLUME +/-** on the remote to set the minutes.
- 5 Press **CLOCK** again to confirm the clock setting.

Notes:

- This system only supports 24-hour mode.
- The clock setting will be erased when the system is disconnected from the power supply.
- The system will exit clock setting mode if no button is pressed within 30 seconds.

Setting sleep/wake-up timer

Sleep timer setting

In power-on mode, the sleep setting enables the system to switch to standby mode automatically at a preset time.

- 1 In power-on mode, press **SLEEP/TIMER** on the remote repeatedly to select a preset time.
→ The selections are as follows (time in minutes):
00 → 10 → 20 → 30 → 40 → 50 → 60 → 70 → 80 → 90 → 00
- 2 When you reach the desired length of time, stop pressing **SLEEP/TIMER**.
→ When sleep function is activated, "z" is displayed.

To deactivate the sleep timer

- Press **SLEEP/TIMER** repeatedly until "OFF" is displayed, or press **STANDBY ON** (⏻) on the remote).
→ When sleep function is deactivated, "z" is disappears on the display.

Wake-up timer setting

In standby mode, the timer setting enables the system to switch on automatically at a set time.

IMPORTANT!

– Before setting the timer, ensure that the clock is set correctly.

- 1 In standby mode, press and hold **SLEEP/TIMER** until the time flashes on the display.
→ "SET TIME" is displayed briefly. Then, the hour digits flash on the display screen.
- 2 Turn **VOLUME +/-** clockwise or anticlockwise or press **VOLUME +/-** on the remote to set the hours.
- 3 Press **SLEEP/TIMER** to confirm.
→ The minute digits flash on the display screen.
- 4 Turn **VOLUME +/-** clockwise or anticlockwise or press **VOLUME +/-** on the remote to set the minutes.
- 5 Press **SLEEP/TIMER** to confirm the time setting.
→ "OFF" flashes on the display screen.
- 6 Turn **VOLUME +/-** clockwise or anticlockwise or press **VOLUME +/-** on the remote to select "ON".
→ ⏻ icon appears on the display screen.

To deactivate the timer

- Select "OFF" at Step 6.

SYSTEM

Power supply	~220V/50 Hz
Rated working power consumption (1/8 rated output power)	≤ 48W
AUX input sensitivity	≤ 350mV
Channel Separation	≥ 40dB
Distortion	0.7%

DVD

Frequency response	100Hz-20kHz (±1dB)
Video output	1 V _{P-P}
Horizontal definition	≥ 500 (TV)
Dimensions ...	163 (W) × 150 (H) × 240(D) mm
Weight	3.1 kg

TUNER

FM Frequency range	87.5-108 MHz
FM Noise limit sensitivity	≤ 20μV/M
FM S/N	≥ 46dB
MW Frequency range	531-1602 kHz
MW Noise limit sensitivity	≤ 3.0μV/m
MW S/N	≥ 40dB

SPEAKER

Impedance	8 Ω
Input power	35W
Sensitivity	80 ± 4dB
Frequency response	80Hz-16kHz
Dimensions ...	134 (W) × 218(H) × 220 (D) mm
Weight	2.3 kg/each

REMOTE

Distance	6m
Angle	± 30°



Specifications and external appearance are subject to change without notice.

Troubleshooting

WARNING

Under no circumstances should you try to repair the system yourself, as this will invalidate the warranty. Do not open the system as there is a risk of electric shock.

If a fault occurs, first check the points listed below before taking the system for repair. If you are unable to remedy a problem by following these hints, consult your dealer or Philips for help.

Problem	Solution
No power.	<ul style="list-style-type: none">✓ Check if the AC power cord is properly connected.✓ Press STANDBY ON  on the top of the DVD micro system or  on the remote to turn on the power.
No picture.	<ul style="list-style-type: none">✓ Check if the TV is switched on.✓ Check the video connection.✓ Press SOURCE on the top of the DVD player repeatedly to select "DVD" or press DISC on the remote.✓ Set your TV to the correct Video In channel. This channel is usually near channel 00. Or; you may have a button on the TV remote control that selects Auxiliary or A/V IN channel. See your TV owner's manual for details. Or; change channels at the TV until you see DVD screen on the TV.✓ If the progressive scan feature is activated but the connected TV does not support progressive signals or the cables are not connected accordingly, see page 43-44 for proper progressive scan setup or deactivate the progressive scan feature as below:<ol style="list-style-type: none">1) Turn off your TV progressive scan mode or turn on to interlaced mode.2) Press SYSTEM on the remote to exit the system menu and then DISC to exit progressive scan.
Distorted or poor picture.	<ul style="list-style-type: none">✓ Sometimes a small amount of picture distortion may appear. This is not a malfunction.✓ Clean the disc.
Completely distorted picture or black/white picture.	<ul style="list-style-type: none">✓ TV has a colour system standard. If the disc's or DVD system's colour system is different than your TV's colour system, the picture may be distorted or colourless.

The aspect ratio of the screen cannot be changed even though you have set the TV shape.

No sound or distorted sound.

The micro DVD player does not start playback.

The DVD micro system does not respond when the buttons are pressed.

Cannot activate some features, such as Angles, Subtitles, or multi-language Audio.

Considerable noise in radio broadcasts. Sound cannot be heard or is of poor quality.

- ✓ The aspect ratio is fixed on the DVD disc.
- ✓ Depending on the TV, it may not be possible to change the aspect ratio.

- ✓ Adjust the volume.
- ✓ Check that the speakers are connected correctly.
- ✓ Replace the speaker cables.
- ✓ Disconnect the headphones.
- ✓ The system is in pause, slow motion or fast forward/reverse mode, press ► || (or ► || on the remote) to resume normal play mode.

- ✓ Insert a readable disc with the playback side facing down.
- ✓ Check the disc type, colour system and regional code. Check for any scratches or smudges on the disc.
- ✓ Press SYSTEM MENU to turn off the setup menu screen.
- ✓ Cancel the parental control rating function or change the rating level.
- ✓ Moisture has condensed inside the system. Remove the disc and leave the system turned on for about an hour.

- ✓ Disconnect the power plug from the outlet and insert again.

- ✓ Multi-language sound or subtitle is not recorded on the DVD.
- ✓ Changing the language for the sound or subtitle is prohibited on the DVD.
- ✓ The features may not be available on the disc.

- ✓ Tune in to the correct frequency.
- ✓ Connect the antennas.
- ✓ Fully extend the FM wire antenna. Position for best reception and secure to a wall.
- ✓ Connect an outdoor FM or AM antenna.
- ✓ Adjust the direction and position for best reception.
- ✓ Place the antenna farther away from any equipment that may be causing the noise.
- ✓ Increase the distance between the system and your TV or other equipment.

Troubleshooting

The remote control does not function.

- ✓ Select the correct source (DISC or TUNER, for example) before pressing the function button.
- ✓ Point the remote control at the remote sensor of the unit.
- ✓ Reduce the distance to the player.
- ✓ Remove any possible obstacles.
- ✓ Replace the batteries with new ones.
- ✓ Check that the batteries are loaded correctly.

The display is dark.

- ✓ Press DIM again.

Low hum or buzz sound.

- ✓ Place the DVD micro system as far away as possible from electrical devices that may be causing interference.

Low bass response.

- ✓ Check all speakers for correct polarity.

Unable to select Progressive Scan

- ✓ Check that the output of the video signal is switched to "Ypbpr".

Analog: Sound that has not been turned into numbers. Analog sound varies, while digital sound has specific numerical values. These jacks send audio through two channels, the left and right.

Aspect ratio: The ratio of vertical and horizontal sizes of a displayed image. The horizontal vs. vertical ratio of conventional TVs is 4:3, and that of wide-screens is 16:9.

AUDIO OUT Jacks: Jacks on the back of the DVD System that send audio to another system (TV set, Stereo, etc.).

Bit Rate: The amount of data used to hold a given length of music; measured in kilobits per second, or kbps. Or, the speed at which you record. Generally, the higher the bit rate the better the sound quality. However, higher bit rates use more space on a Disc.

Chapter: Sections of a picture or a music piece on a DVD that are smaller than titles. A title is composed of several chapters. Each chapter is assigned a chapter number enabling you to locate the chapter you want.

Component Video Out Jacks: Jacks on the back of the DVD System that send high-quality video to a TV set that has Component Video In jacks (R/G/B, Y/Pb/Pr, etc.).

Disc menu: A screen display prepared for the selection of images, sound, subtitles, multi-angles, etc recorded on a DVD.

Digital: Sound that has been converted into numerical values. Digital sound is available when you use the DIGITAL AUDIO OUT COAXIAL or OPTICAL jacks. These jacks send audio through multiple channels, instead of just two channels as analog does.

Dolby Digital: A surround sound system developed by Dolby Laboratories containing up to six channels of digital audio (front left and right, surround left and right and center).

DTS: Digital Theater Systems. This is a surround sound system, but different from Dolby Digital. The formats were developed by different companies.

JPEG: A still-picture data compression system proposed by the Joint Photographic Expert Group, which features small decrease in image quality in spite of its high compression ratio.

MP3: A file format with a sound data compression system. "MPE" is the abbreviation of Motion Picture Experts Group 1 (or MPEG-1) Audio Layer 3. Through the MP3 format, one CD-R or CD-RW can contain about 10 times as much data volume as a regular CD can.

Multichannel: DVD is specified to have all sound tracks constitute one sound field. Multichannel refers to a structure of sound tracks having three or more channels.

Parental control: A function of the DVD to limit playback of the disc by the age of the users according to the limitation level in each country. The limitation varies from disc to disc; when it is activated, playback will be prohibited if the software's level is higher than the user-set level.

PCM (Pulse Code Modulation): A system for converting analog sound signal to digital signal for later processing without data compression.

Playback control (PBC): Refers to the signal recorded on video CDs or SVCDs for reproduction control. By using screen menus recorded on a Video CD or SVCD that supports PBC, you can enjoy interactive-type software as well as software having a search function.

Progressive Scan (P-Scan): It displays all the horizontal lines of a picture at one time, as a signal frame. This system can convert interlaced video from DVD into progressive format for connection to a progressive display. It dramatically increases the vertical resolution. A progressive scan TV set is needed to receive progressive scan output from the system.

Region code: A system allowing discs to be played only in preset regions. This unit will only play discs that have compatible region codes. You can find the region code of your unit from the product label. Some discs are compatible with more than one region (or ALL regions).

S-Video: Produces a clear picture by sending separate signals for luminance and the color. You can use S-Video only if your TV set has S-Video In jack.

Sampling Frequency: Frequency of data sampling when analog data is converted to digital data. Sampling frequency numerically represents how many times the original analog signal is sampled per second.

Surround: A system for users to create realistic three-dimensional sound fields full of realism by arranging multiple speakers around the listener.

Title: The longest section of a picture or music feature on DVD, music, etc., in video software, or the entire album in audio software. Each title is assigned a title number enabling you to locate the title you want.

VIDEO OUT jack: Jack on the back of the DVD System that sends video to TV.