

Register your product and get support at  
[www.philips.com/welcome](http://www.philips.com/welcome)



---

EN User manual

---

ZH-CN 用户手册

---

**PHILIPS**

# Contents

---

<b>1 Important</b>	4
Safety	4
Notice	4
Introduction	5
What's in the box	5
Overview of the main unit	6
Overview of the remote control	7

---

<b>2 Get started</b>	9
Install the car audio	9
Install remote control battery	13
Turn on	13
Set date and time	13

---

<b>3 Use map</b>	15
Upgrade the map	15

---

<b>4 Listen to radio</b>	16
Tune to a radio station	16
Store radio stations in memory	16
Tune to a preset station	17

---

<b>5 Play</b>	18
Load discs	18
Connect USB device	18
Insert USB or SD/MMC card	19
Play/Pause	19
Search for a folder	19
Search within a title/folder	20
Repeat	20
Repeat a section	21
Random play	21
Select audio language	21
Select audio mode	21
Select subtitle language	21
Change view angle	22
Rotate pictures	22
Zoom	22
Select slide show duration	22

---

<b>6 Play with Bluetooth device</b>	23
Pair the Bluetooth-enabled devices	23
Make a call	23
Receive call	24
Listen to music from Bluetooth device	24
Adjust Bluetooth settings	24

---

<b>7 Adjust sound</b>	26
Adjust volume	26
Mute	26
Select preset equalizer	26
Adjust fader/balance	26
Set Dynamic Bass Boost (DBB)	27

---

<b>8 Adjust settings</b>	28
Display system setup menu	28
Adjust general settings	28
Adjust sound settings	29
Adjust video settings	29
Adjust Bluetooth settings	30
Adjust language settings	31
Adjust volume settings	31
Adjust DVD rating	31

---

<b>9 Others</b>	33
Listen to other devices	33
Reset	33
Remove the unit	33
Replace fuse	34

---

<b>10 Product information</b>	35
-------------------------------	----

---

<b>11 Troubleshooting</b>	37
About Bluetooth device	37

---

<b>12 Glossary</b>	39
--------------------	----

# 1 Important

## Safety

- Read and understand all instructions before you use the apparatus. If damage is caused by failure to follow instructions, the warranty does not apply.
- Use of controls or adjustments or performance of procedures other than herein may result in hazardous radiation exposure or other unsafe operation.
- This unit is designed for negative ground (earth) 12 V DC operation only.
- To reduce the risk of traffic accident, do not watch video during driving.
- To ensure safe driving, adjust the volume to a safe and comfortable level.
- Improper fuses can cause damage or fire. When you need to change the fuse, consult a professional.
- Use only the supplied mounting hardware for a safe and secure installation.
- To avoid short circuit, do not expose the apparatus, remote control or remote control batteries to rain or water.
- Never insert objects into the ventilation slots or other openings on the apparatus.
- Never place any objects other than discs into the disc tray/slot.
- Visible and invisible laser radiation when open. Avoid exposure to beam.
- Risk of damage to the screen! Never touch, push, rub or strike the screen with any object.
- Never use solvents such as benzene, thinner, cleaners available commercially, or anti-static sprays intended for discs.
- Clean the apparatus with soft, damp cloth. Never use substances such as alcohol, chemicals or household cleaners on the apparatus.

## Notice



The making of unauthorized copies of copy-protected material, including computer programs, files, broadcasts and sound recordings, may be an infringement of copyrights and constitute a criminal offence. This equipment should not be used for such purposes.



"DivX, DivX" Certified, and associated logos are trademarks of DivX, Inc. and are used under license.

Official DivX® Certified product. Plays all versions of DivX® video (including DivX® 6) with standard playback of DivX® media files. The Bluetooth® word mark and logos are registered trademarks owned by Bluetooth SIG, Inc. and any use of such marks by Philips is under license.



Manufactured under license from Dolby Laboratories.

"Dolby" and the double-D symbol are trademarks of Dolby Laboratories. Other trademarks and trade names are those of their respective owners.

**This apparatus includes this label:**

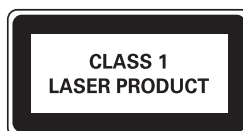

## Environmental information

All unnecessary packaging has been omitted. We have tried to make the packaging easy to separate into three materials: cardboard (box), polystyrene foam (buffer) and polyethylene (bags, protective foam sheet.)

Your system consists of materials which can be recycled and reused if disassembled by a specialized company. Please observe the local regulations regarding the disposal of packaging materials, exhausted batteries and old equipment.

Any changes or modifications made to this device that are not expressly approved by Philips Consumer Lifestyle may void the user's authority to operate the equipment.

2008 © Koninklijke Philips Electronics N.V. All rights reserved.

Specifications are subject to change without notice. Trademarks are the property of Koninklijke Philips Electronics N.V. or their respective owners. Philips reserves the right to change products at any time without being obliged to adjust earlier supplies accordingly. Congratulations on your purchase, and welcome to Philips! To fully benefit from the support that Philips offers, register your product at [www.philips.com/welcome](http://www.philips.com/welcome).

## Introduction

With the car entertainment system, you can

- Quickly found routine through the navigation system  
And you can also enjoy:
  - Audio/video/JPEG pictures from
    - DVD, VCD or CD
    - USB devices
    - SD/SDHC/MMC cards
    - External devices
  - FM or AM (MW) radio
  - Audio from Bluetooth-enabled devices
- Besides, you can make/receive phone calls with Bluetooth-enabled devices.

## What's in the box

Check and identify the contents of your package:

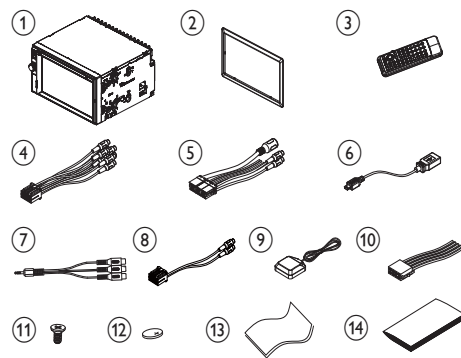

- ① Main unit
- ② Trim plate
- ③ Remote control
- ④ AV out cable
- ⑤ Control/Camera wire
- ⑥ USB cable
- ⑦ AV in cable
- ⑧ MZ-TFT/Video out 2 cable
- ⑨ GPS antenna
- ⑩ ISO connectors (x2)
- ⑪ Screws
  - M5x6mm x 8 pcs
  - M5x7mm x 8 pcs
  - M5x15 x 1pc
  - Screw nut (4x25.4) x 1 pc
- ⑫ Remote control battery
- ⑬ Screen cleaning cloth
- ⑭ Printing material (include User manual, Quick start guide)

## Overview of the main unit

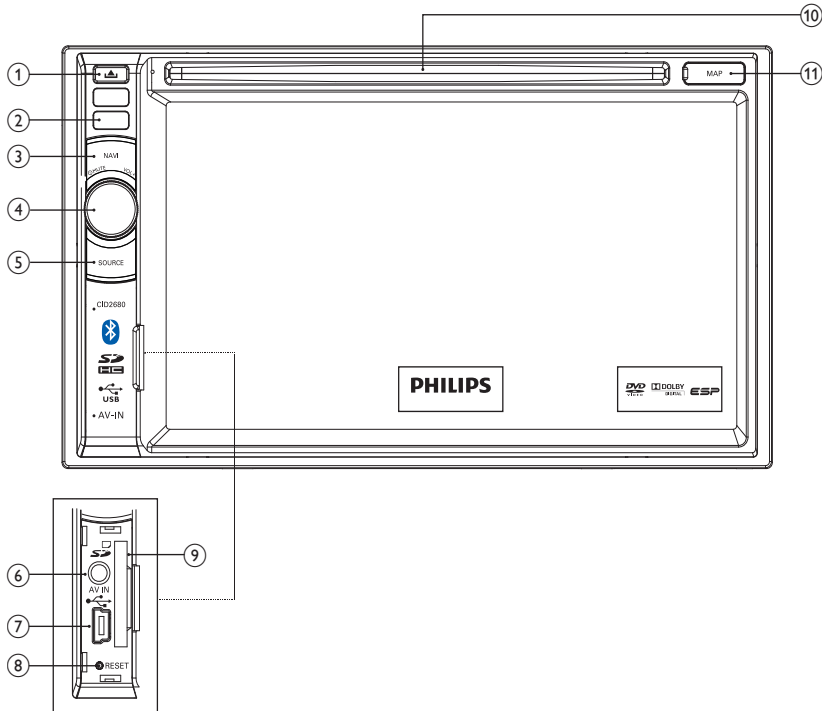

① ▲

- Eject disc.

② **Remote control sensor**

- Detects signals from the remote control. When using the remote control, point it directly at the IR sensor.

③ **NAVI**

- Enter the GPS navigation system or exit.

④ **⓪/MUTE/VOL -/+**

- Turn the unit on or off.
- Turn mute on or off.
- Adjust volume.

⑤ **SOURCE**

- Select source.

⑥ **AV IN**

- External equipment audio/video in socket.

⑦ **USB**

- USB socket

⑧ **RESET**

- Reset the unit when it hangs up.

⑨ **SD/SDHC/MMC card slot**

⑩ **Disc slot**

⑪ **MAP**

- Open the cover and insert/remove the GPS map card.

## Overview of the remote control

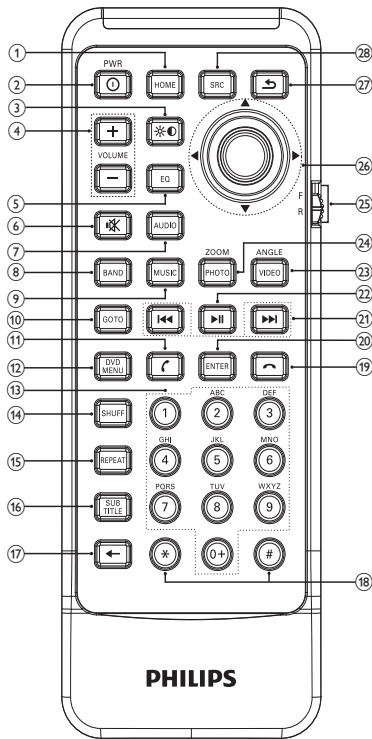

- ① **HOME**
- Toggles the home menu on or off.
- ② **⓪PWR**
- Turn the unit on or off.
- ③ **☀️**
- Adjust screen brightness/contrast.
- ④ **VOLUME +/-**
- Adjust volume.
- ⑤ **EQ**
- Access audio setting menu.
- ⑥ **🔇**
- Mute or unmute audio.
- ⑦ **AUDIO**
- Select audio language or audio channel.
- ⑧ **BAND**
- Select AM or FM band.
- ⑨ **MUSIC**
- Switch to music playing mode.
- ⑩ **GOTO**
- Select track/chapter.
- ⑪ **☎️ (green)**
- Answer phone.
  - Dial number.
- ⑫ **DVD MENU**
- Return to DVD main menu.
- ⑬ **Numeric keypad**
- ⑭ **SHUFF**
- Turn random play on or off.
- ⑮ **REPEAT**
- Select repeat play mode.
- ⑯ **SUBTITLE**
- Select DVD or DivX subtitle language.
- ⑰ **←**
- Delete entered numbers/characters.
- ⑱ **#/ \***
- Symbols for making phone call.
- ⑲ **📞 (red)**
- Terminate call.
- ⑳ **ENTER**
- Confirm the character/number inputs.
- ㉑ **⏮️⏭️**
- Skip to previous/next track/chapter.
  - Tune for radio station.
- ㉒ **▶️⏸️**
- Start play or pause.
  - Confirm selection.

- ②③ **VIDEOANGLE**
  - Select a different angle/version of the current DVD scene.
- ②④ **PHOTOZOOM**
  - Zoom in or out a picture/video image.
- ②⑤ **F/R**
  - Switch to front/rear control mode.
- ②⑥ **Navigation buttons**
  - ▲/▼
    - Skip to the previous/next preset station.
    - Skip to the previous/next folder.
    - Search backward/forward for DVD video.
    - Move cursor up/down.
  - ◀▶
    - Skip to the previous/next track.
    - Move cursor to left/right.
  - Press the navigation button down
    - Start play or pause.
    - Confirm selection.
- ②⑦ **↶**
  - Return to previous menu or exit.
- ②⑧ **SOURCE**
  - Select source.

## 2 Get started

### ! Caution

- Use of controls or adjustments or performance of procedures other than herein may result in hazardous radiation exposure or other unsafe operation.

Always follow the instructions in this chapter in sequence.

### Install the car audio

These instructions are for a typical installation. However, if your car has different requirements, make the corresponding adjustment. If you have any questions regarding installation kits, consult your Philips car audio dealer.

### ! Caution

- This unit is designed for negative ground (earth) 12 V DC operation only.
- Always install this unit in the car dashboard. Other locations can be dangerous as the rear of the unit heats up during use.
- To avoid short-circuit: before you connect, ensure that the ignition is off.
- Ensure that you connect the yellow and red power supply leads after all other leads are connected.
- Ensure that all loose leads are insulated with electrical tape.
- Ensure that the leads do not get caught under screws or in parts that will move (e.g. seat rail).
- Ensure that all ground (earth) leads are run to a common ground (earth) point.
- Use only the supplied mounting hardware for a safe and secure installation.
- Improper fuses can cause damage or fire. When you need to change the fuse, consult a professional.

#### Note on the power supply lead (yellow)

- When you connect other devices to this system, ensure that the rating of the car circuit is higher than the total fuse value of all the connected devices.

#### Notes on speaker connection

- Never connect speaker wires to the metal body or chassis of the car.
- Never connect speaker wires with stripes to one another.

#### Connect wires

### ! Caution

- Ensure that all loose leads are insulated with electrical tape.

- 1 Check the car's wiring carefully, then connect them to the two supplied ISO wires.

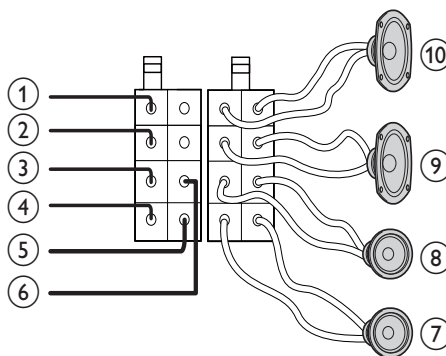

Connector	Connect to
1	Brown wire Telephone mute
2	Red wire <b>The +12V power terminal which is live in the accessory (ACC) position of the ignition switch</b> If there is no accessory position, connect to the +12V car battery terminal that is always live. Be sure to connect the black ground (earth) lead to a metal surface of the car first.

3	Orange wire	Illumination switch
4	Black wire	<b>A metal surface of the car</b> First connect the black ground (earth) lead, then connect the yellow and red power supply leads.
5	Yellow wire	<b>The +12V car battery which is live at all times.</b>
6	Blue wire	<b>The electric antenna control lead or power supply lead of the antenna booster</b> If there is no electric antenna or antenna booster, or it is manually operated telescopic antenna, it is not necessary to connect this lead.
7	Green and green/black wires	<b>Left speaker (Rear)</b>
8	White and white/black wires	<b>Left speaker (Front)</b>
9	Gray and gray/black wires	<b>Right speaker (Front)</b>
10	Purple and purple/black wires	<b>Right speaker (Rear)</b>

**2** Connect the other end of the two ISO connectors to the car audio system.

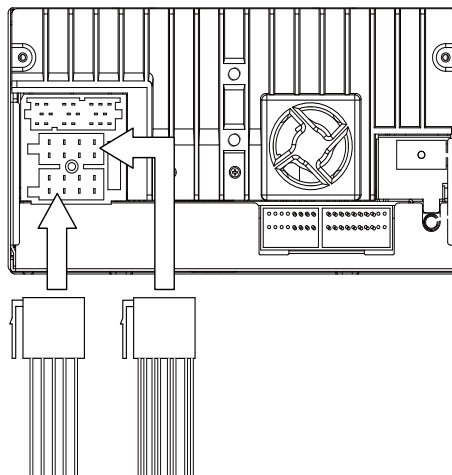

**3** If necessary, do the other connections:

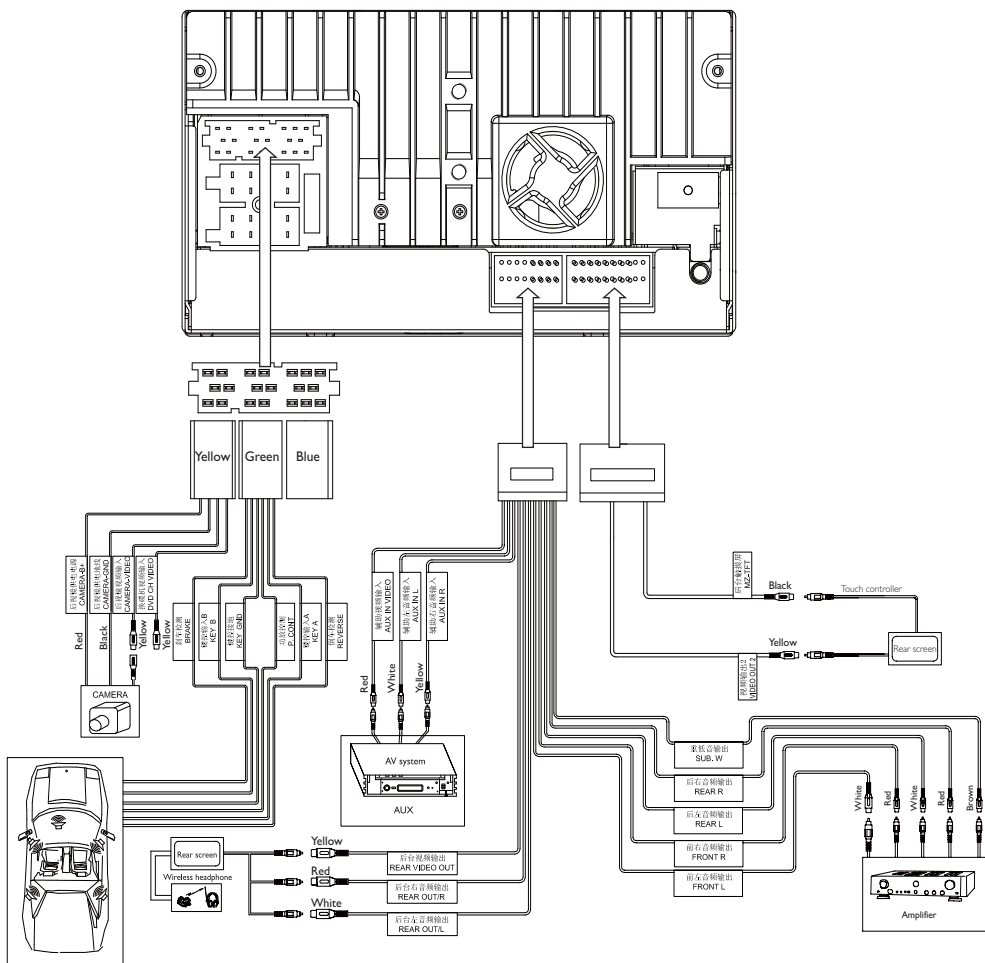

### Connect GPS antenna

To receive signal from satellites, connect the supplied GPS antenna to your car and the system.

- 1 Connect the supplier GPS antenna to the system first.

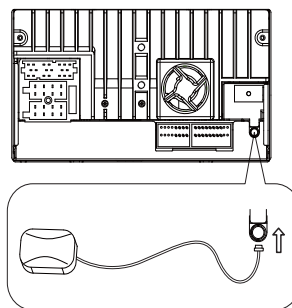

- 2 Stick the other end of the GPS antenna to a metal surface of the car.

## Connect radio antenna

If your car has built-in radio antenna, connect it to the radio antenna of the system for better radio signal.

- 1 Connect the radio antenna to the car antenna.

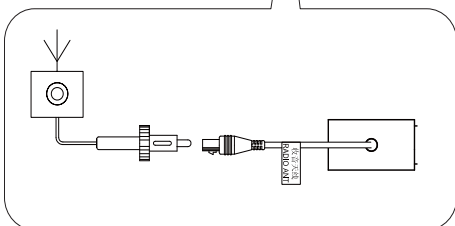
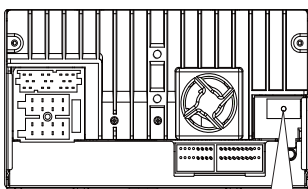

## Mount in the dashboard

### Note

- Check wire connection before you mount the unit into a car.
- If preset radio stations are lost when the ignition key is turned OFF and then back ON, reconnect the red leads crosswise to the yellow ones.

- 1 If the car does not have an on-board drive or navigation computer, disconnect the negative terminal of the car battery.
  - If you disconnect the car battery in a car that has an on-board drive or navigation computer, the computer may lose its memory.

- If the car battery is not disconnected, to avoid short-circuit, ensure that bare wires do not touch each other.

- 2 Ensure that car dashboard opening is within these measurements:

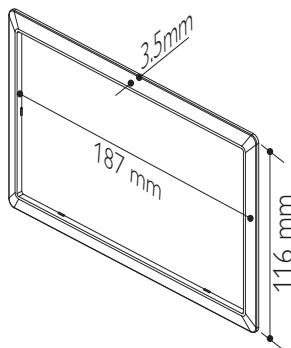

- Since the unit cannot be used if the dashboard opening's slant angle is above 20 degrees: Ensure that the horizontal slant of the car dashboard opening is between 0 and 20 degrees.

- 3 Slide the unit into the dashboard until a click sound is heard.

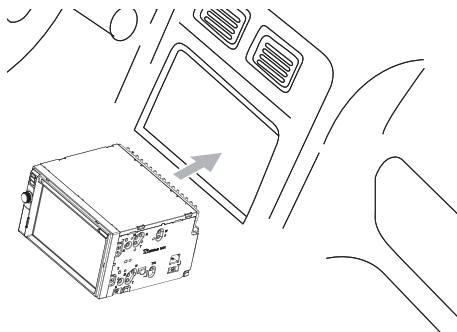

- 4 Attach the trim plate.

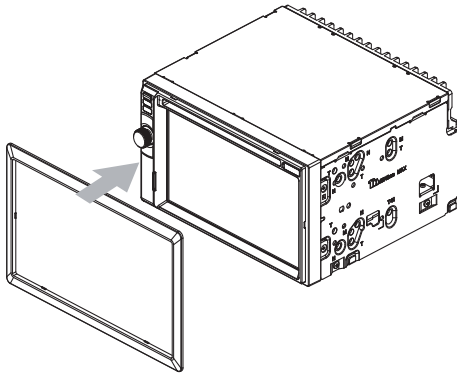

- 5 Reconnect the negative terminal of the car battery.

## Install remote control battery

### ! Caution

- Risk of explosion! Keep batteries away from heat, sunshine or fire. Never discard batteries in fire.

### ≡ Note

- Remove batteries if they are exhausted or if the remote control is not to be used for a long time.
- Batteries contain chemical substances, they should be disposed of properly.
- Perchlorate Material - special handling may apply. See [www.dtsc.ca.gov/hazardouswaste/perchlorate](http://www.dtsc.ca.gov/hazardouswaste/perchlorate).

- 1 Open the battery compartment.
- 2 Insert one CR2025 battery with correct polarity (+/-) as indicated.
- 3 Close the battery compartment.

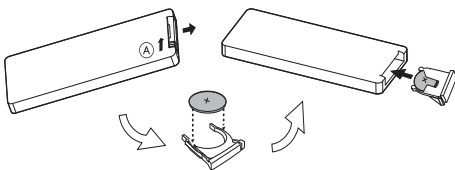

## Turn on

### ! Caution

- Risk of road accidents! Never watch video or adjust settings while you drive.

- 1 Press  $\odot$  to turn on the unit.
  - ↳ The available OSD (On-Screen Display) languages are displayed.

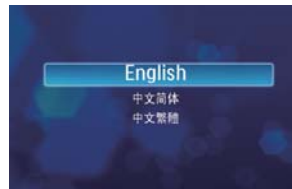

- 2 Touch a language to select.
  - ↳ The OSD language is changed to the selected language immediately.
  - To adjust screen brightness/contrast, press  $\otimes/\odot$  on the remote control, then press  $\leftarrow$ ,  $\rightarrow$ ,  $\blacktriangle$  or  $\blacktriangledown$ .
  - To turn off the unit, press  $\odot$  for 3 seconds.

## Set date and time

- 1 Touch the upper left corner to display main menu.



- 2 Touch  $\bullet$  in the middle right side of the screen.
  - ↳ The second main menu is displayed.



- 3 Touch [Settings].
- 4 Touch [Time].  
↳ The date/time setup menu is displayed.



#### Set date

- 1 Touch [Date].
- 2 Touch on the displayed date information.  
↳ A submenu is displayed.



- 3 Touch ▲ or ▼ to set year, month and day.

#### Set clock mode

- 1 Touch [Clock mode].



- 2 Touch on [12Hr] or [24Hr] to select clock mode.

#### Set time

- 1.Touch [Time].
- 2.Touch on the displayed time.  
↳ A submenu is displayed.



- 3.Touch ▲ or ▼ to set hour and minute.



#### Tip

- When date/time is set, touch ⏪ first and then touch ▶ to return to main menu.

## 3 Use map

### Note

- You may need to upgrade the map before using it (see "Upgrade the map" section)

- 1 Touch the upper left corner to display home menu.
- 2 Touch [Navigation].  
↳ The navigation menu is displayed in a few seconds.



- 3 Refer to the map manual (in Chinese) to operate the navigation tool.



### Tip

- You can press **NAVI** to enter/exit the navigation system.

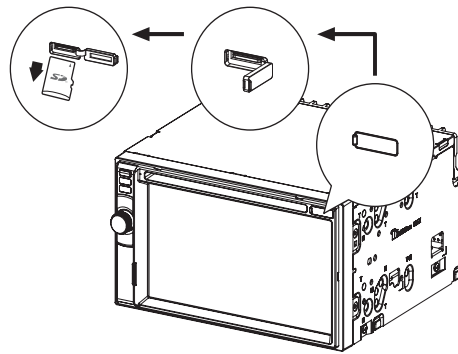

- 4 Insert the upgraded map card back into the map card slot.
- 5 Turn on the car audio.  
↳ The map upgrades in a few minutes.

## Upgrade the map

- 1 Turn off the car audio system.
- 2 Press the map card until you hear a click sound.
- 3 Take out the card and bring it to the authorized service center for upgrade.

## 4 Listen to radio

### Tune to a radio station

- 1 Touch the upper left corner to display home menu.
- 2 Touch **[Radio]**.  
↳ Band and frequency information is displayed.



- 3 Touch on **FM** or **AM** to select band:
  - FM band options: **FM1, FM2, FM3**
  - AM band options: **AM1, AM2**
- 4 Briefly touch **◀** or **▶** to tune to a radio station by step.
  - Touch **◀** or **▶** for over 1 seconds to tune to a radio station automatically.

### Tune by frequency

- 1 Touch **[Menu]**.

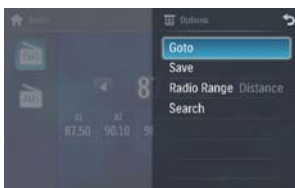

- 2 Touch **[Goto]**.
- 3 Touch **FM** or **AM** to select band.
- 4 Touch the numbers to enter frequency.



- Touch **←** to clear the last entered number.
  - Touch **×** to clear all the entered numbers.
- 5 Touch **✓** to confirm.  
↳ The radio station is broadcast.

### Select radio range

Before you start to search for radio stations, you can select radio range.

- 1 Touch **[Menu]**.
- 2 Touch **[Radio range]** to toggle tuner sensitivity from normal to high sensitivity.
  - **[Distance]**: Only stations with strong signals can be broadcast.
  - **[Local]**: Stations with strong and weak signals can be broadcast.

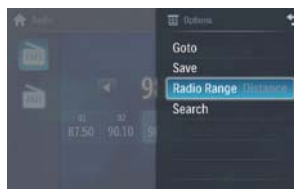

### Store radio stations in memory

You can store up to 6 stations in each band.

### Store stations manually

- 1 Tune to the station.
- 2 Touch **[Menu]**.
- 3 Touch **[Save]**.

- 4 Touch one of the channels **01** to **06** to save the select band.



## Store stations automatically

You can search for a station with intro search, which broadcasts a 10-second preview of each detected radio station.

- 1 Select band.
- 2 Touch .
- 3 Touch **[Search]**.
  - ↳ Auto search starts. The six strongest stations of the selected band are saved in preset channels 1-6 automatically.

## Tune to a preset station

- 1 Touch **[Radio]**.
- 2 Select band.
- 3 Touch one of the preset channels (**01** to **06**) to select a preset station.



# 5 Play

## Load discs

You can play video, audio or images stored on the following discs:

- DVD video, DVD-R, DVD-RW
- VCD
- Audio CD, CD-R, CD-RW

### Note

- Ensure that the disc contains playable content.

- 1 Insert the disc into the disc slot with label side facing up.  
↳ Play starts automatically.

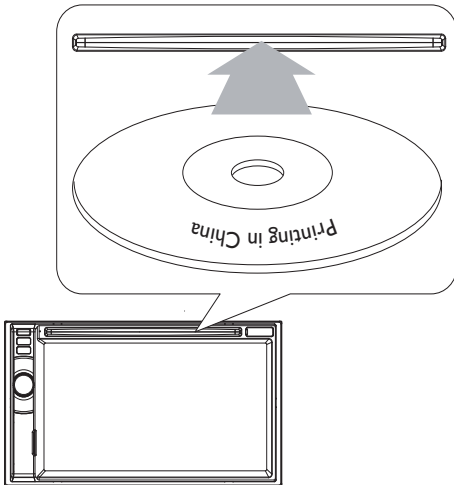

- ↳ To remove the disc, press the ▲ button.
- ↳ When the disc is ejected, the unit switches to the previous source, if connected. Otherwise, the unit switches to **[Radio]** mode automatically.

## Connect USB device

### Note

- Ensure that the device contains playable content.

- 1 Open the USB door.

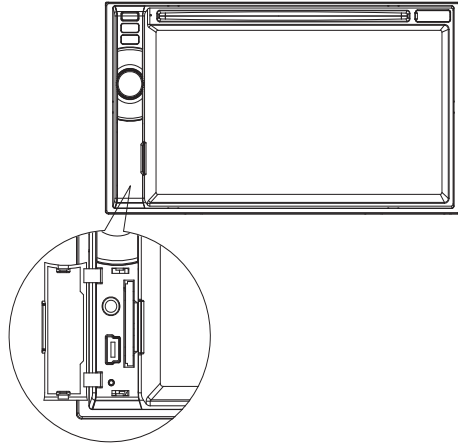

- 2 Insert the small end of the supplied USB cable to the USB socket, then connect the other end of the USB cable to your USB device.  
↳ Play starts automatically.

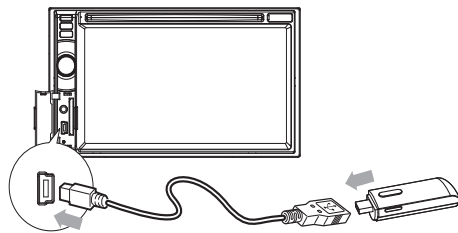

## Remove the USB device

- 1 Press **SOURCE** to switch to another source.
- 2 Remove the USB device.

## Insert USB or SD/MMC card

### Note

- Ensure that the device contains playable content.
- The unit supports SDHC card.

- 1 Open the USB/SD/MMC card cover.
- 2 Insert the SD/MMC card into the SD/MMC card slot.  
↳ Play starts automatically.

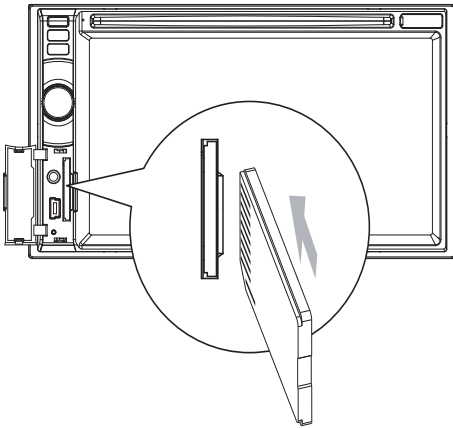

## Remove the SD/MMC card

- 1 Press **SOURCE** to switch to another source.
- 2 Press the card until you hear a click sound.  
↳ The card is now disengaged.
- 3 Remove the SD or MMC card.

## Play/Pause

- 1 Once a disc, USB or SD/MMC card is inserted, play starts automatically.



For DVD movie, if a menu appears, press to start play.

- 2 To pause, touch **⏸**.  
• To resume play, touch **▶** again.

## Search for a folder

For video files

- 1 Touch **↶** to return to playlist menu.
- 2 Touch **📁** to display all available video file folders.



- 3 Touch a folder, then touch **▲** or **▼** to select a file.
- 4 Touch **▶** to start play.

For audio files

- 1 Touch **↶** to return to playlist menu.
- 2 Touch **🎵** to display all available audio folders.



3 Touch a folder, then touch ▲ or ▼ to select a file.

4 Touch ▶ to start play.

#### For picture files

1 Touch ↶ to return to playlist menu.

2 Touch 📁 to display all available picture folders.

3 Touch a folder, then touch ▲ or ▼ to select a picture.

4 Touch ▶ to view the picture.

## Search within a title/folder

### Search by step

1 Touch anywhere except for the upper left corner to display menu on the screen, if necessary.

2 Touch ▲ or ▼ to skip to the previous or next chapter/track.

### Direct search

1 Touch anywhere except for the upper left corner to display menu on the screen, if necessary.

2 Touch 📄  
↳ The search screen is displayed.

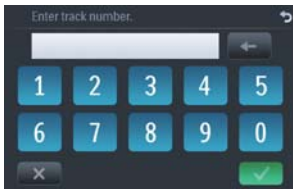

↳ For video files, touch 📄 first, then touch 📄.

3 Touch the numbers to enter chapter/file number; then touch ✓.  
• To clear the previous input, touch ←.  
• To clear all input, touch ✕.

## Repeat

During play, you can select different repeat play modes.

### For DVD/VCD movie disc:

1 Touch anywhere except for the upper left corner to display menu on the screen, if necessary.



2 Touch **1/2** to display the 2nd menu.



3 Touch 🔄 to select:  
• **[Repeat chapter]**: play the current chapter repeatedly.  
• **[Repeat title]**: play all chapters in the title repeatedly.  
• **[Repeat off]**: cancel repeat play.

### For VCD karaoke or audio CD:

1 Touch anywhere except for the upper left corner to display menu on the screen, if necessary.

2 Touch 🔄 to select:  
• **[Repeat]**: play the current track repeatedly.  
• **[Repeat off]**: cancel repeat play.

### For MP3/WMA files:

1 Touch anywhere except for the upper left corner to display menu on the screen, if necessary.

2 Touch 🔄 to select:  
• **[Repeat]**: play the current track repeatedly.

- **[Repeat folder]**: play all the tracks in the current folder repeatedly.
- **[Repeat off]**: cancel repeat play.

#### Tip

- You can also press **REPEAT** on the remote control to select repeated play mode.



## Repeat a section

You can repeat a specific section of video file (repeat A-B).

- 1 During play, touch anywhere except for the upper left corner to display menu on the screen, if necessary.
- 2 Touch **1/2** to display the 2nd menu, if necessary.
- 3 Touch **A-B** repeatedly to mark:
  - **[Repeat A-]**: the start of the section to repeat.
  - **[Repeat A-B]**: the end of the section to repeat.
  - The selected section plays repeatedly.
- 4 To exit A-B repeat mode, touch **A-B** repeatedly until **[Repeat A-B off]** is displayed.

## Random play

You can play audio tracks/files in random order.

- 1 During play, touch  repeatedly to turn random play on or off.
  -  is highlighted : start random play.
  -  turns gray: cancel random play.

#### Tip

- You can also press **SHUFF** on the remote control to select random play mode.

## Select audio language

For video discs that contain two or more audio channels.

- 1 During play, touch anywhere except for the upper left corner to display menu on the screen, if necessary.
- 2 Touch **1/2** to display the 2nd menu.
- 3 Touch  repeatedly.
  - ↳ The audio channel information is displayed on the upper line of the screen.

## Select audio mode

When you play VCDs, you can select an audio mode (R/L/Stereo).

- 1 During play, touch anywhere except for the upper left corner to display menu on the screen.
- 2 Touch  repeatedly until the audio mode is selected.

## Select subtitle language

For DVD or DivX discs that contain two or more subtitle languages.

- 1 During play, touch anywhere except for the upper left corner to display menu on the screen, if necessary.
- 2 Touch **1/2** to display the 2nd menu
- 3 Touch  repeatedly to select a language.
  - ↳ The selected language is displayed.

#### Tip

- You may also press **SUBTITLE** on the remote control repeatedly to select subtitle language.

---

## Change view angle

Some DVDs contain alternate scenes, such as scenes recorded from different camera angles. For such DVDs, you can select from the available alternate scenes.

- 1 During play, touch anywhere except for the upper left corner to display menu on the screen, if necessary.
- 2 Press **VIDEOANGLE** repeatedly on the remote control.  
↳ The view angle is changed.

---

## Rotate pictures

- 1 When you view pictures, touch anywhere except for the upper left corner to display menu on the screen, if necessary.



- 2 Touch  repeatedly to rotate the picture.





---

## Zoom

You can zoom in pictures for a close view.

- 1 During view pictures, touch anywhere except for the upper left corner to display menu on the screen, if necessary.
- 2 Touch  repeatedly to zoom in the picture.



- 3 Touch , ,  or  to pan through the enlarged picture.



Tip

- To zoom in/out video image, press **PHOTOZOOM** on the remote control.

---

## Select slide show duration

- 1 Touch anywhere except for the upper left corner to display menu on the screen, if necessary.
- 2 Touch  repeatedly to select:
  - **Fast:** 3 seconds
  - **Normal:** 5 seconds
  - **Slow:** 8 seconds

## 6 Play with Bluetooth device

You can make or receive phone calls with Bluetooth-enabled phones through the unit. You can also listen to music from a Bluetooth-enabled device.

### Pair the Bluetooth-enabled devices

To connect your Bluetooth device to the unit, you need to pair the device to the unit. Pairing needs only to be done once.

You can pair up to eight devices.



#### Note

- The operational range between this unit and a Bluetooth device is approximately 10 meters (30 feet).
- Before you connect a Bluetooth device to this unit, familiarize yourself with the Bluetooth capabilities of the device.
- Compatibility with all Bluetooth devices is not guaranteed.
- Any obstacle between this unit and a Bluetooth device can reduce the operational range.
- Keep this unit away from any other electronic device that may cause interference.

- 1 Turn on the Bluetooth function on the device.
- 2 Search for Bluetooth device with the device.
- 3 Select "CID2680" in the pairing list.
- 4 Enter default password "0000".  
↳ if pairing succeeds, phone call record is displayed.



### Disconnect Bluetooth devices

- 1 To disconnect one device, touch  (red).  
↳  (green) is displayed.





#### Tip

- The device will also be disconnected when the device is moved beyond the operational range.
- If you want to reconnect the device to the unit, place it within the operational range.
- If you do not want to reconnect the device to the unit automatically, touch  > [Auto connect], then select [Off]. For details, see the "Adjust Bluetooth settings" section.

### Make a call

- 1 Pair the phone with the unit.
- 2 Touch the upper left corner to display the home menu.
- 3 Touch [Bluetooth].  
↳ The Bluetooth menu is displayed.



- 4 Touch  or  to select the paired phone, then touch .
- 5 Touch  or  to search for phone number from the following list:



- [Missed calls]
- [Received calls]
- [Dialed calls]
- [Phone book]
- [Sim phone book]
- [Local phone book]

Or touch to dial number directly, then touch to dial.

## Receive call

By default, all incoming calls are received automatically.

- 1 If there is incoming call, [Incoming call...] flashes on the screen. Speak into the Bluetooth microphone.

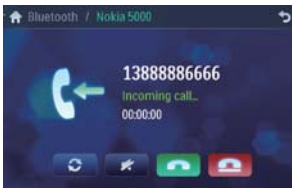

- 2 When conversation ends, touch (red) to terminate the call.

### Tip

- You can select to receive calls manually by set [Auto answer] to [Off] status.

## Switch phone call to the mobile

If you do not want your passenger to hear your incoming call, you can switch the call to the mobile.

- 1 During talking, touch .

↳ The voice is transferred from the unit's loudspeaker to the mobile phone.

## Listen to music from Bluetooth device

If the connected Bluetooth device supports Advanced Audio Distribution Profile (A2DP), you can listen to the music stored on the device through the unit. If the device also supports AudioVideo Remote Control Profile (AVRCP) profile, you can use the control on the unit or its remote control to play music stored on the device.

- 1 Pair the phone with the unit.
- 2 Touch the upper left corner to return to home menu.
- 3 Touch [Bluetooth].
  - ↳ The Bluetooth menu is displayed.
- 4 Start play music via device.
  - If your device support AVRCP.
- 1 Touch .

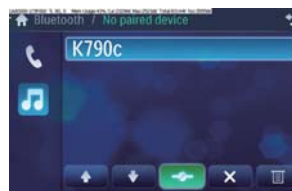

- 2 Touch to start play.

## Adjust Bluetooth settings

You can change below Bluetooth settings:

- [Bluetooth]: to turn on or off "Bluetooth" function
- [Auto connect]: to turn on or off "Auto connect" function
- [Auto answer]: to turn on or off "Auto answer" function
- [Pairing code]: to set pairing code

- **[Phone Book Sync]**: to synchronize phone book

- 1 In Bluetooth menu, touch .  
↳ The option menu is displayed.





- 2 Touch on the selected option to change the setting.

 Tip



- You can also adjust Bluetooth settings in the "Settings" menu.

# 7 Adjust sound

## Adjust volume

- 1 Turn  clockwise to increase volume.
- Turn  anti-clockwise to reduce volume.

## Mute

- 1 During play, press .
  - To turn the sound back on, press  again.



### Tip

- You can also turn off sound by touching  on the screen.







## Select preset equalizer

You can select preset equalizer:

- [User]
- [Techno]
- [Rock]
- [Classic]
- [Jazz]
- [Optimal]
- [Flat]
- [Pop]

- 1 Touch anywhere except for the upper left corner to display menu on the screen, if necessary.
- 2 Touch .
  - ↳ The current Equalizer setting is displayed.



- 3 Touch  or  to select an EQ.
- 4 Touch  or  to adjust below settings:
  - [Bass] bass range: -14 to +14.
  - [Mid] middle range: -14 to +14.
  - [Treb] treble range: -14 to +14.
  - [LPH] low pass filter range: 60, 80, 100, 200.
  - [MPF] middle pass filter range: 500, 1K, 1.5K, 2.5K.
  - [HPF] high pass filter range: 10K, 12.5K, 15K, 17.5K.
- 5 Touch  to restore the above settings into default settings.
- 6 Press  to exit.



## Adjust fader/balance

You can also adjust the front and rear speaker balance, the left and right speaker balance, and subwoofer settings.

Touch anywhere except for the upper left corner to display menu on the screen, if necessary.

- 1 Touch .
- 2 Touch .
  - ↳ Below options are displayed:





- 3 Touch  or  to select subwoofer volume.
  - [Sub] subwoofer volume: 0 to 24.

- 4 Touch **F**, **R**, **L**, or **R** to adjust fader/balance value.
  - **[Fade]** fader range: +24 to -24.  
(F = front speaker; R = rear speaker)
  - **[Balance]** balance range: -24 to +24.  
(L = left speaker; R = right speaker)
- 5 Touch ↶ to exit.

---

## Set Dynamic Bass Boost (DBB)

- 1 Touch  to toggle between the settings.
  - **[DBB]** on: The  icon is illuminated.
  - **[DBB]** off (default): The  icon is gray.

## 8 Adjust settings

### Display system setup menu

- 1 Touch the upper left corner to display main menu.





- 2 Touch  in the middle right side of the screen.  
↳ The second main menu is displayed.



- 3 Touch **[Settings]**.  
↳ The settings menu is displayed.



#### Tip

- When the setup adjustment is completed, touch  first and then touch  to return to main menu.

### Adjust general settings

- 1 Touch **[General]**, if necessary.



- 2 Touch  or  to highlight a setting.
- 3 Touch on the option to display/select an option.

General settings	Options	Description
<b>[Radio region]</b>	[USA], [S.Amer-1], [Arabia], [China], [S.Amer-2], [Europe], [Korea], [OIRT]	Select one that matches your location.
<b>[Radio range]</b>	[Local]	Only stations with strong signals can be broadcast.
	[Distance]	Stations with strong and weak signals can be broadcast.
<b>[Blackout]</b>	[off]	Never turn on the screen saver.
	[10s]	Turn on the screen saver automatically 10 seconds after last operation.
	[20s]	Turn on the screen saver automatically 20 seconds after last operation.
<b>[Auto dimmer]</b>	[On]	Turn on the screen dim automatically 5 seconds after last operation.
	[Off]	Never turn the screen dim.
<b>[Key color]</b>	[Red]	Button backlight turns red.
	[Blue]	Button backlight turns blue.

[Beep]	[On]	Turn on the beep sound. Each time you press a button, the unit beeps.
	[Off]	Turn off the beep sound.
[Calibration]		Calibrate the touch screen.

4 Press ↵ to exit.

## Adjust sound settings

1 Touch [Sound].



2 Touch an option repeatedly to select:

Sound settings	Options	Description
[Sub woofer]	[On]	Turn on the subwoofer.
	[Off]	Turn off the subwoofer.
[Sub woofer filter]	[80Hz]	Select subwoofer filter criteria.
	[120Hz]	
	[160Hz]	
[DBB]	[On]	The Dynamic Bass Boost (DBB) function is on.
	[Off]	The DBB function is off.
[DRC]	[On]	Makes loud sound level softer and soft sound level louder so that you can watch the DVD movies at a low volume, without disturbing others.
	[Off]	The DRC function is off.

3 Press ↵ to exit.

## Adjust video settings

1 Touch [Video].



2 Touch an option repeatedly to select:

Video settings	Options	Description
[Aspect ratio]	[Full]	For widescreen display.
	[Normal]	For normal display.
[Video input]	[Auto]	The correct format is set automatically. Select this option if you are not sure which format should be selected.
	[NTSC]	Used in the United States, Canada, Japan, Mexico, the Philippines, South Korea, Taiwan, and some other countries.
	[PAL]	Used in China, India, Singapore, the western European countries (except France), Australia, and some other countries.
	[Secam]	Used in France, Russia and other countries.
[Rear camera]	[Normal]	When you drive in reverse, the rear view is displayed normally.
	[Mirror]	When you drive in reverse, the rear view is displayed in mirror.
[Parking]	[On]	Disable video view during drive.
	[Off]	Enable video view during drive.
[DivX registration code]		View code for DivX registration.

3 Press  to exit.

## Adjust Bluetooth settings

1 Touch [Bluetooth].



2 Touch an option repeatedly to select:

Bluetooth settings	Options	Description
[Bluetooth]	[On]	Turn on the Bluetooth function.
	[Off]	Turn off the Bluetooth function.
[Auto connect]	[On]	If the pre-paired device is within the effective range, the unit re-connects to pre-paired device automatically.
	[Off]	Need to re-connect manually.
[Auto answer]	[On]	Answer paired phone call automatically.
	[Off]	Answer phone call manually.
[Pairing code]		View code for pairing the unit with other Bluetooth devices.

3 Press  to exit.

## Adjust language settings

- 1 Touch [Language].



- 2 Touch an option repeatedly to select:

Language settings	Options	Description
[OSD]	[English]	Select on-screen-display language.
	[简体中文]	
	[繁体中文]	
[DVD audio]	[English]	Select DVD audio language. Options available are depends on DVD disc.
	[简体中文]	
	[繁体中文]	
[DVD subtitle]	[English]	Select DVD subtitle language. Options available are depends on DVD disc.
	[简体中文]	
	[繁体中文]	
	[Off]	Turn off subtitle language display.
[Disc menu]	[English]	Select DVD menu language. Options available are depends on DVD disc.
	[简体中文]	
	[繁体中文]	

- 3 Press ↵ to exit.

## Adjust volume settings

You can set different volume for different modes.

- 1 Touch [Volume].
  - ↳ The volume setting sub-menu is displayed.



- 2 Touch on a source.
  - [DVD]
  - [USB]
  - [SDHC]
  - [Radio]
  - [Bluetooth]
  - [AV-IN1]
  - [AV-IN2]
  - [CDC]
  - [TV]
  - [Navigation]
- 3 Touch ▲ or ▼ to assign value: 0 to 12.
  - ↳ When switches to the source, the volume increases automatically.
- 4 Press ↵ to exit.

## Adjust DVD rating

- 1 Touch [DVD rating].



- 2 Touch an option repeatedly to select:

DVD rating	Options	Description
[Set password]		Set password to restrict the play of discs. The default password is 0000.
[Rating level]	[Kid safe]	Acceptable for children.
	[G]	Acceptable for general viewers.
	[PG]	Parental guidance suggested.
	[PG-13]	Unsuitable for children under age 13.
	[PG-R]	Recommend parents to restrict children under 17 to view.
	[R]	Restricted. Recommend parent to guide children under 17 to view.
	[NC-17]	Unsuitable for children under age 17.
	[Adult]	Acceptable for adults only.
[Load factory]		Restore to default settings.

**3** Press  to exit.

## 9 Others

### Listen to other devices

You can connect an external audio/video device to the unit.

- 1 Connect the car audio to the device with the supplied AV cable.

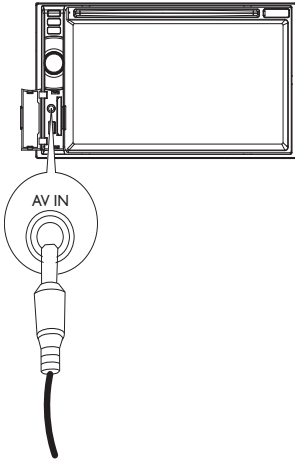

- 2 Touch the upper left corner to display the main menu.
- 3 Touch [AV-IN1].
- 4 Operated the connected the device (see the instructions manual of the device).

#### Tip

- If you connected the system to other audio device through the **REAR OUT L/R** connector (see "Connect wires" section), touch [AV-IN2] to listen to that device.

### Reset

When the unit hangs up, you can reset it.

- 1 Press **RESET** with a ball-point pen or similar tool.

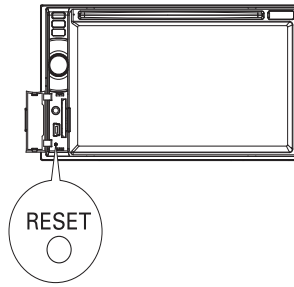

#### Tip

- When the unit is reset, all the settings remain unchanged.

### Remove the unit

To repair, replace fuse, or replace the unit with another car audio, remove it from the dashboard.

- 1 Take off the trim plate.
- 2 Screw off the four (4) screws on the left/right side of the unit.
- 3 Pull the unit out from the dashboard.

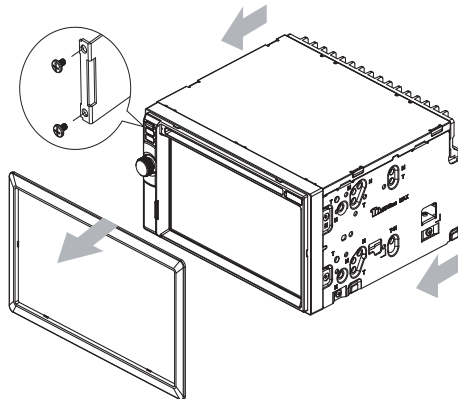

---

## Replace fuse

If there is no power, the fuse may be damaged and need to be replaced.

- 1 Take out the unit from dashboard.
- 2 Check the electric connection.
- 3 Buy a fuse that matches the voltage of the damaged fuse (15A)
- 4 Replace the fuse.

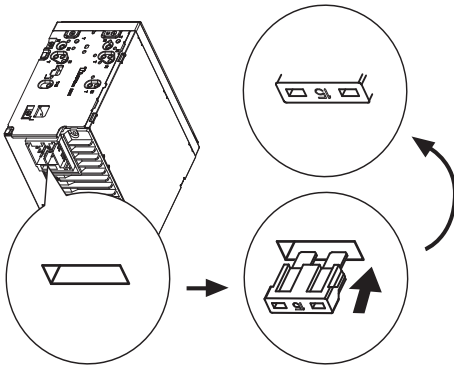

If the fuse gets damaged immediately after it has been replaced, there may be an internal malfunction. In such case, consult your Philips dealer:

# 10 Product information



## Note

- Product information is subject to change without prior notice.

## General

Power supply	12 V DC (11 V - 16 V), negative ground
Fuse	15 A
Suitable speaker impedance	4 - 8 $\Omega$
Maximum power output	50 W $\times$ 4 channels
Continuous power output	24 W $\times$ 4 channels (4 $\Omega$ 10% T.H.D.)
Pre-Amp output voltage	2.0 V ( CD play mode; 1 kHz, 0 dB, 10 k $\Omega$ load)
Subwoofer output voltage	2.0 V (CD play mode, 61 Hz, 0 dB, 10 k $\Omega$ load)
Aux-in level	$\geq$ 500 mV
Dimensions (W $\times$ H $\times$ D)	178 $\times$ 101 $\times$ 160 mm
Weight (main unit)	2.5 kg

## Disc player

System	DVD / CD audio / MP3 system
Frequency response	20 Hz - 20k Hz
Signal/noise ratio	>75dB
Total harmonic distortion	Less than 1%
Channel separation	>55dB
Video signal format	NTSC only
Video output	1 +/- 0.2V

## Tuner

Frequency range - FM	87.5 - 108.0 MHz (Europe)
Frequency range - AM (MW)	522 - 1620 KHz (Europe)
Usable sensitivity - FM	5 $\mu$ V
Usable sensitivity - AM (MW)	50 $\mu$ V

## LCD

Screen size	6.5 inches (16:9)
Display resolution	800 $\times$ 480 dots
Contrast ratio	300
Brightness	350 cd/m <sup>2</sup>

## Bluetooth

Communication system	Bluetooth Standard version 2.0
Output	Bluetooth Standard Power Class 2
Maximum communication range	Line of sight approx. 8m
Frequency band	2.4 GHz band (2.4000 GHz - 2.4835 GHz)
Compatible Bluetooth profiles	Hands-Free Profile (HFP) Handset Profile (HSP) Advanced Audio Distribution Profile (A2DP) Audio Video Remote Control Profile (AVRCP)
Supported codecs	SBC (Sub Band Codec)
Receive	SBC (Sub Band Codec)
Transmit	

**Compatible USB devices:**

- USB flash memory (USB 2.0 or USB1.1)
- USB flash players (USB 2.0 or USB1.1)
- memory cards (SD / MMC / SDHC)

**Supported formats:**

- USB or memory file format: FAT16, FAT32
- MP3 bit rate (data rate): 32-320 Kbps and variable bit rate
- WMA v9 or earlier
- Directory nesting up to a maximum of 8 levels
- Number of albums/ folders: maximum 99
- Number of tracks/titles: maximum 999
- ID3 tag v2.0 or later
- File name in Unicode UTF8 (maximum length: 128 bytes)

**Unsupported formats:**

- Empty albums: an empty album is an album that does not contain MP3/WMA files, and is not be shown in the display.
- Unsupported file formats are skipped. For example, Word documents (.doc) or MP3 files with extension .dlf are ignored and not played.
- AAC, WAV, PCM audio files
- DRM protected WMA files (.wav, .m4a, .m4p, .mp4, .aac)
- WMA files in Lossless format

**Supported MP3 disc format:**

- ISO9660, Joliet
- Maximum title number: 512 (depending on file name length)
- Maximum album number: 255
- Supported sampling frequencies: 32 kHz, 44.1kHz, 48 kHz
- Supported Bit-rates: 32-320 Kbps and variable bit rate

**Supported video formats:**

- DVD
- Divx Home theater
- MP4
- Xvid

**Note**

- To ensure a better playback, bit rate of 4.5 Mbps is recommended.

# 11 Troubleshooting



## Warning

- Never remove the casing of this apparatus.

To keep the warranty valid, never try to repair the system yourself.

If you encounter problems when using this apparatus, check the following points before requesting service. If the problem remains unsolved, go to the Philips web site ([www.philips.com/welcome](http://www.philips.com/welcome)). When you contact Philips, ensure that the apparatus is nearby and the model number and serial number are available.

### No power

- Car engine has not been started. Start the car engine.
- Connections is incorrect.
- Fuse has been damaged. Replace fuse (see 'Replace fuse' on page 36).

### No sound

- Volume is too low. Adjust volume.
- Speaker connections is incorrect.

### No response to the remote control

- Ensure that the path between the remote control and the unit is clear from obstacles.
- From a close distance, point the remote control directly at the unit.
- Switch **F/R** to correct position (**F** for front control and **R** for rear control).
- The function does not work. Refer to the instructions.
- Replace the remote control battery.

### Disc does not play

- Disc is upside down. Ensure the printed side is upwards.
- Disc is dirty. Clean the disc with a clean, soft, lint-free cloth. Wipe the disc outwards from the center.
- Disc is defective. Try another disc.
- incompatible disc is used. Try another disc.

- Disc rating exceeds the restrict setting. Change the rating settings to lower one.
- Disc region code is not compatible with the unit. Use disc with proper region code.

### No image

- Parking brake wire connection is incorrect. Check the parking wiring.

### Image flashes or distorted

- Video DVD settings do not match with the DVD. Adjust video DVD settings.
- Video connection is improper. Check the connections.

### Noise in broadcasts.

- Signals are too weak. Select other stations with stronger signals.
- Check the connection of the car antenna.
- Change broadcast from stereo to mono.

### Preset stations lost.

- Battery cable is not correctly connected. Connect the battery cable to the terminal that is always live.

### Fuse is broken

- The Fuse type is incorrect. Replace it with a 15A fuse.
- Speaker wire or power wire is grounded. Check the connections.

### Display show ERR-12

- USB/SD/MMC data error. Check the USB device or SD/MMC card.

---

## About Bluetooth device

### Music playback is unavailable on the system even after successful Bluetooth connection.

- The device cannot be used with the system to play music.

### The audio quality is poor after connection with a Bluetooth-enabled device.

- The Bluetooth reception is poor. Move the device closer to the system or remove any obstacle between the device and the system.

### Cannot connect with the system.

- The device does not support the profiles required for the system.

- The Bluetooth function of the device is not enabled. Refer to the user manual of the device for how to enable the function.
- The system is not in the pairing mode.
- The system is already connected with another Bluetooth-enabled device. Disconnect that device or all other connected devices and then try again.

**The paired mobile phone connects and disconnects constantly.**

- The Bluetooth reception is poor. Move the mobile phone closer to the system or remove any obstacle between the mobile phone and the system.
- Some mobile phones may connect and disconnect constantly when you make or end calls. This does not indicate any malfunction of the system.
- For some mobile phones, the Bluetooth connection may be deactivated automatically as a power-saving feature. This does not indicate any malfunction of the system.

# 12 Glossary

---

## B

### **Bite rate**

The max data transfer through the USB port.

### **Bluetooth**

Bluetooth® is a short-rang wireless protocol that is meant to allow mobile devices to share information and applications without the worry of cables or interface incompatibilities. The name refers to a Viking King who unified Denmark. Operate at 2.4GHz. For more information, see [www.bluetooth.com](http://www.bluetooth.com).

## M

### **MMC**

MultimediaCard. A type of memory card with a flash memory.

### **MP3**

A file format with a sound data compression system. MP3 is the abbreviation of Motion Picture Experts Group 1 (or MPEG-1) Audio Layer 3. With the MP3 format, one CD-R or CD-RW can contain about 10 times more data than a regular CD.

## R

### **Region code**

A system that allows discs to be played only in the region designated. This unit only plays discs that have compatible region codes. You can find the region code of your unit on the product label. Some discs are compatible with more than one region (or ALL regions.)

## S

### **SD**

Secure Digital. A type of memory card with a flash memory.

### **SDHC**

Secure Digital High Capacity (SDHC) is a type of flash memory card based on the SDA 2.00 specification. The SDA 2.00 specification enables SD cards to reach higher capacities from 4GB to 32GB, and growing.

## W

### **WMA (Windows Media Audio)**

An audio format owned by Microsoft, is a part of Microsoft Windows Media technology. Includes Microsoft Digital Rights Management tools, Windows Media Video encoding technology, and Windows Media Audio encoding technology.



© 2008 Koninklijke Philips Electronics N.V.

All rights reserved.

CID2680\_93\_UM\_V1.1