

# Always there to help you

Register your product and get support at  
[www.philips.com/welcome](http://www.philips.com/welcome)



CED1800BT



## User manual

# PHILIPS



# Contents

<b>1</b>	<b>Safety</b>	<b>2</b>
<b>2</b>	<b>Your car entertainment system</b>	<b>3</b>
	Introduction	3
	Playable media	3
	What's in the box	3
	Overview of the main unit	4
	Overview of the remote control	5
<b>3</b>	<b>Install the car entertainment system</b>	<b>6</b>
	Connect wires	7
	Mount into the dashboard	10
<b>4</b>	<b>Get started</b>	<b>11</b>
	Prepare the remote control	11
	Turn on	11
	Use the home menu	12
	Set the date and time	12
	Adjust the screen brightness	13
	Switch display designs	13
<b>5</b>	<b>Play from hard media</b>	<b>14</b>
	Load a disc	14
	Connect a USB storage device	14
	Control play	15
	Browse recorded files	16
<b>6</b>	<b>Listen to radio</b>	<b>17</b>
	Switch to radio mode	17
	Set up	17
	Tune to a radio station	17
	Store radio stations in memory	17
	Tune to a preset radio station	18
<b>7</b>	<b>Use the navigation system</b>	<b>18</b>
	Insert the map data card	18
	Navigate your road trip	19
<b>8</b>	<b>Use Bluetooth devices</b>	<b>19</b>
	Activate the Bluetooth function	19
	Pair a device	19
	Play audio from a connected device	21
	Make a call	22
<b>9</b>	<b>Adjust sound</b>	<b>23</b>
	Adjust the volume level	23
	Mute sound	23
	Enable the MAX Sound feature	23
	Enable the DBB sound effect	23
	Enable the FullSound effect	24
	Select a preset sound equalizer	24
	Others	24
<b>10</b>	<b>Adjust settings</b>	<b>25</b>
	Access system setup menus	25
	Adjust general settings	26
	View system information	26
	Adjust Navigation settings	26
	Adjust Bluetooth settings	27
<b>11</b>	<b>Others</b>	<b>28</b>
	Play external audio/video input	28
	Use rear monitors	28
	Use buttons on the steering wheel	29
	Set the rear view camera	29
	Reset the system	29
	Replace the fuse	30
	Upgrade the firmware	30
<b>12</b>	<b>Product information</b>	<b>31</b>
<b>13</b>	<b>Troubleshooting</b>	<b>32</b>
	General	32
<b>14</b>	<b>Notice</b>	<b>33</b>
	Compliance	33
	Care of the environment	33
	Trademark notice	33
	Copyright	34

# 1 Safety

Read and understand all instructions before you use the device. If damage is caused by failure to follow instructions, the warranty does not apply.

- Use of controls or adjustments or performance of procedures other than herein may result in hazardous radiation exposure or other unsafe operation.
- The device is designed for negative ground (earth) 12 V DC operation only.
- To reduce the risk of traffic accidents, do not watch video when driving.
- To ensure safe driving, adjust the volume to a safe and comfortable level.
- Improper fuses can cause damage or fire. When you need to change the fuse, consult a professional.
- Use only the supplied mounting hardware for a safe and secure installation.
- To avoid short circuits, do not expose the device, remote control or remote control batteries to rain or water.
- The device shall not be exposed to dripping or splashing.
- Do not place any sources of danger on the device (e.g. liquid filled objects, lighted candles).
- Never insert objects into the ventilation slots or other openings on the device.
- Never place any objects other than discs into the disc tray/slot.
- To avoid exposure to laser radiation, do not disassemble the device.
- Risk of damage to the screen! Never push, rub, or strike the screen with any object.
- Never use solvents such as benzene, thinner, cleaners available commercially, or anti-static sprays intended for discs.
- Clean the device with soft, damp cloth. Never use substances such as alcohol, chemicals or household cleaners on the device.
- Risk of swallowing coin battery!
- The product/remote control may contain a coin/button type battery, which can be swallowed. Keep the battery out of reach of children at all times! If swallowed, the battery can cause serious injury or death. Severe internal burns can occur within two hours of ingestion.
- If you suspect that a battery has been swallowed or placed inside any part of the body, seek immediate medical attention.
- When you change the batteries, always keep all new and used batteries out of reach of children. Ensure that the battery compartment is completely secure after you replace the battery.
- If the battery compartment cannot be completely secured, discontinue use of the product. Keep out of reach of children and contact the manufacturer.

# 2 Your car entertainment system

Congratulations on your purchase, and welcome to Philips! To fully benefit from the support that Philips offers, register your product at [www.philips.com/welcome](http://www.philips.com/welcome).

## Introduction

With the car entertainment system, you can

- listen to music,
- watch videos,
- view pictures,
- listen to FM and AM/MW radio,
- make phone calls via Bluetooth, and
- navigate your road trip.

## Playable media

- Disc
  - DVD, Video CD, SVCD, Audio CD, JPEG Picture CD, MP3-CD, WMA-CD
  - DVD-R, DVD-RW, DVD+R, DVD+RW, CD-R, CD-RW
- USB storage device
  - Compatibility: USB 2.0, USB 1.1
  - Class support: MSC (Mass Storage Class)
  - Maximum capacity: 32 GB
- Files
  - File system: FAT16, FAT32
  - Maximum number of folders: 99
  - Maximum number of tracks/files: 999
  - Maximum level of directory: 8
  - Video formats: MPEG1, MPEG2
  - Picture format: .jpeg
  - .mp3 files

Sampling frequencies: 32 kHz, 44.1 kHz, 48 kHz  
Bitrates: 8-320 kbps and variable bitrates

- .wma files
  - Versions: V4, V7, V8, V9 (L1 and L2)
  - Sampling frequencies: 44.1 kHz, 48 kHz
  - Bitrates: 64-192 kbps and variable bitrates
- ID3 tag V2.0 or later
- **Unsupported files:**  
AAC, WAV, and PCM files  
DRM protected WMA files (.wav, .m4a, .m4p, .mp4, and .aac)  
WMA files in lossless format

## What's in the box

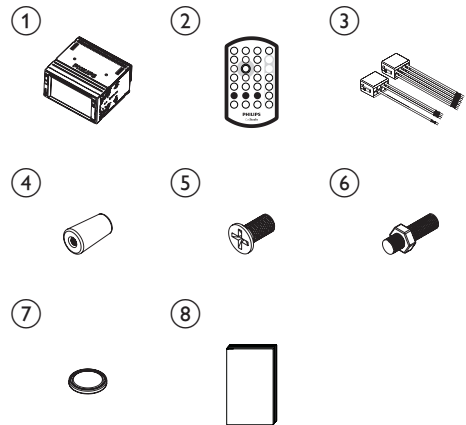

Check and identify the contents of the package:

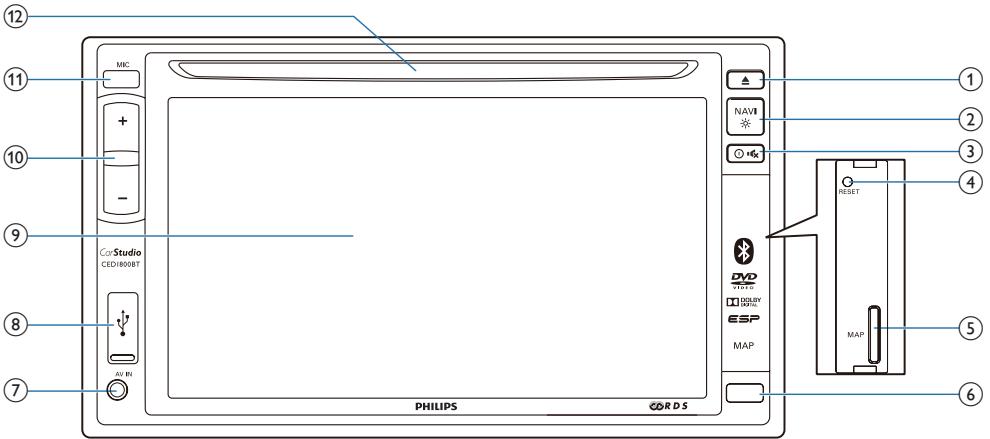

1	Main unit	2	Remote control
3	ISO male connector X 2	4	Rubber cushion
5	Screw X 4 (M5x8mm)	6	Hexagon head screw
7	Remote control battery	8	User manual

## Overview of the main unit



- ① ▲
  - Press to eject the disc.
- ② NAVI  
\*
  - Press to access the navigation system.
  - Press and hold to adjust the brightness of LCD screen.
- ③ 
  - Press to power on the unit.
  - Press and hold to power off the unit.
  - Press to mute the speakers or release them from mute status.
- ④ **RESET**
  - Press to reset the system.
- ⑤ **MAP**
  - Insert a micro SD card that stores the digital map data.
- ⑥ **iR sensor**
  - The sensor that receives infra-red signals from the remote control.
- ⑦ **AV-IN**
  - Connect to the audio and video output sockets of an external player by a composite AV cable.
- ⑧ 
  - Connect to a USB storage device.
- ⑨ **LCD screen**
- ⑩ +/-
  - Press to increase or decrease the volume.
- ⑪ **MIC**
  - The built-in microphone for phone calls.
- ⑫ **Disc slot**

## Overview of the remote control

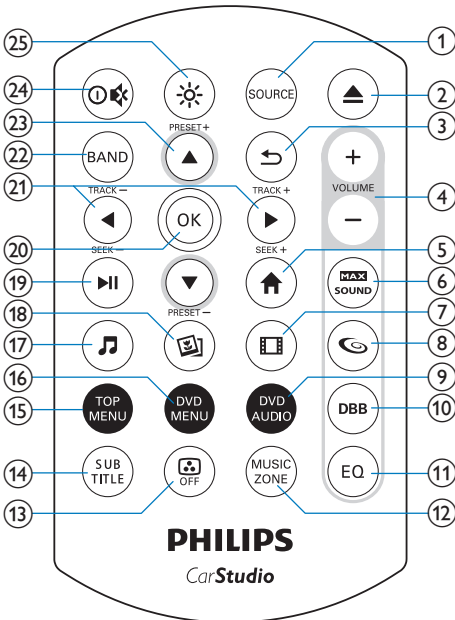

### ① SOURCE

- Press repeatedly to select a source.

### ② ▲

- Press to eject the disc.

### ③ ↶

- Return to the previous menu or mode.

### ④ VOLUME + / -

- Press to increase or decrease the volume.

### ⑤ 🏠

- Access the home menu.

### ⑥ MAX SOUND

- Enable or disable the **MAX Sound** feature.

### ⑦ 📺

- Switch to video playback mode.

### ⑧ 🌀

- Enable or disable the FullSound effect.

### ⑨ DVD AUDIO

- Select an audio language or audio channel.

### ⑩ DBB

- Enable or disable the DBB (Dynamic Bass Boost) sound effect.

### ⑪ EQ

- Select a preset sound equalizer.

### ⑫ MUSIC ZONE

- Select a music listening zone.

### ⑬ OFF

- Turn on or off the screen.

### ⑭ SUB TITLE

- Select an available subtitle.

### ⑮ TOP MENU

- Access the top menu.

### ⑯ DVD MENU

- Access the DVD menu.

### ⑰ 🎵

- Switch to music playback mode.

### ⑱ 🖼️

- Switch to picture slideshow mode.

### ⑲ ⏸

- Start, pause, or resume the play.

### ⑳ OK

- Confirm an option.

### ㉑ ◀ / ▶ / TRACK - / TRACK +



- Skip to the previous or next track, chapter, or file.
- For DVD, press and hold to select a speed for fast backward or forward search.

### ㉒ BAND

- Select a tuner band.

### ㉓ ▲ / ▼ / PRESET + / PRESET -

- Tune to the previous or next preset radio station.
- Skip to the previous or next folder.

- 24  
- Press to power on the system.
  - Press and hold to power off the system.
  - Press to mute the speakers or release them from mute status.
- 25 
- Press to adjust the brightness of the LCD screen.

## 3 Install the car entertainment system

Always follow the instructions in this chapter in sequence.

These instructions are for a typical installation. However, if your car has different requirements, make the adjustment accordingly. If you have any question regarding installation kits, consult your local retailer.



### Note

- This system is designed for negative ground (earth) 12V DC operation only.
- Always install this system in the car dashboard. Other locations can be dangerous as the rear of the system heats up during use.
- To avoid short-circuit: before you connect, make sure that the ignition is off.
- Make sure that you connect the yellow and red power supply leads after all other leads are connected.
- Make sure that all loose leads are insulated with electrical tape.
- Make sure that the leads do not get caught under screws iron parts that will move (e.g. seat rail).
- Make sure that all ground (earth) leads are run to a common ground (earth) point.
- Use only the supplied mounting hardware for a safe and secure installation.
- Improper fuses can cause damage or fire. When you need to change the fuse, consult a professional.
- When you connect other devices to this system, make sure that the rating of the car circuit is higher than the total fuse value of all the connected devices.
- Never connect speaker wires to the metal body or chassis of the car.
- Never connect speaker wires with stripes to one another.



# Connect wires

## Note

- Make sure that all loose leads are insulated with electrical tape.
- Consult a professional to connect wires as instructed below.
- Before connection, check the car's wiring carefully.

## 1 Connect the ISO male connectors.

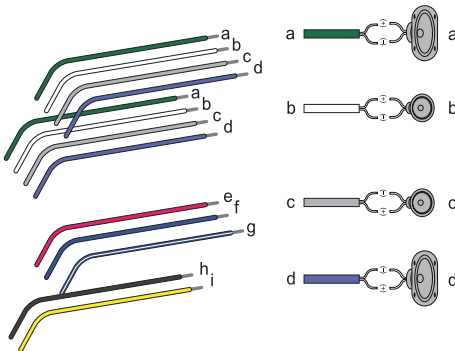

ISO male connectors	Connect to
a Green strip, black-edged green strip	Rear left speaker
b White strip, black-edged white strip	Front left speaker
c Gray strip, black-edged gray strip	Front right speaker
d Purple strip, black-edged purple strip	Rear right speaker
e Red strip	Ignition key +12V DC when ON/ ACC
f Blue strip	Motor/electric antenna relay control lead
g White-edged blue strip	Amplifier relay control lead
h Black strip	Ground
i Yellow strip	The +12V car battery which is energized at all times

## 2 Connect other wires if necessary.

## Caution

- To avoid an accident, the driver must not watch video while driving. By design, this system disallows watching video during drive. Park your car in a safe place and engage the parking brake before watching video.

## Note

- When the parking brake of your vehicle is not engaged, the video blocking system is activated. It blocks the display of front video source only.
- If the system is not properly connected with the parking brake control module of your vehicle, video signals will be blocked by the system, with the below message displayed on the TFT.



Connectors and sockets on rear panel	External sockets or connectors
1 For ISO male connectors	As indicated above
2 <b>REAR OUT R</b> (Red socket)	Rear right speaker
3 <b>AV-IN R</b> (Red socket)	Right audio channel output socket of an external player
4 <b>AV-IN L</b> (White socket)	Left audio channel output socket of an external player
5 <b>REAR OUT L</b> (White socket)	Rear left speaker
6 <b>VIDEO IN</b> (Yellow socket)	Video output socket of an external player

	Connectors and sockets on rear panel	External sockets or connectors
7	<b>VIDEO OUT 1</b> (Yellow socket)	Video input socket of an external display device
8	<b>VIDEO OUT 2</b> (Yellow socket)	Video input socket of an external display device
9	<b>RADIO ANTENNA</b> (Black connector)	Radio antenna
10	<b>CAMERA IN</b> (Purple socket)	Video output socket of an external camera
11	<b>SUB-W OUT</b> (Blue socket)	Sub-woofer
12	<b>REVERSE CAMERA</b> (Purple wire)	Reverse camera (B+)
13	<b>PARKING BRAKE</b> (Pink wire)	Parking brake (-)
14	<b>OE SWC IR REMOTE IN</b> (Brown wire)	OE SWC remote in
15	<b>OE SWC IR REMOTE IN</b> (Black wire)	Ground
16	<b>OE SWC AD LEARN</b> (White wire)	OE SWC AD Learn line 1
17	<b>OE SWC AD LEARN</b> (White wire)	OE SWC AD Learn line 2
18	<b>OE SWC AD LEARN</b> (Black wire)	Ground
19	<b>External Mic</b> (Black connector)	External microphone
20	<b>GPS AERIAL</b> (Black connector)	GPS smart antenna

### Tip

- The pin arrangement for the ISO connectors depends on the type of your vehicle. To avoid damage to the system, connect properly.

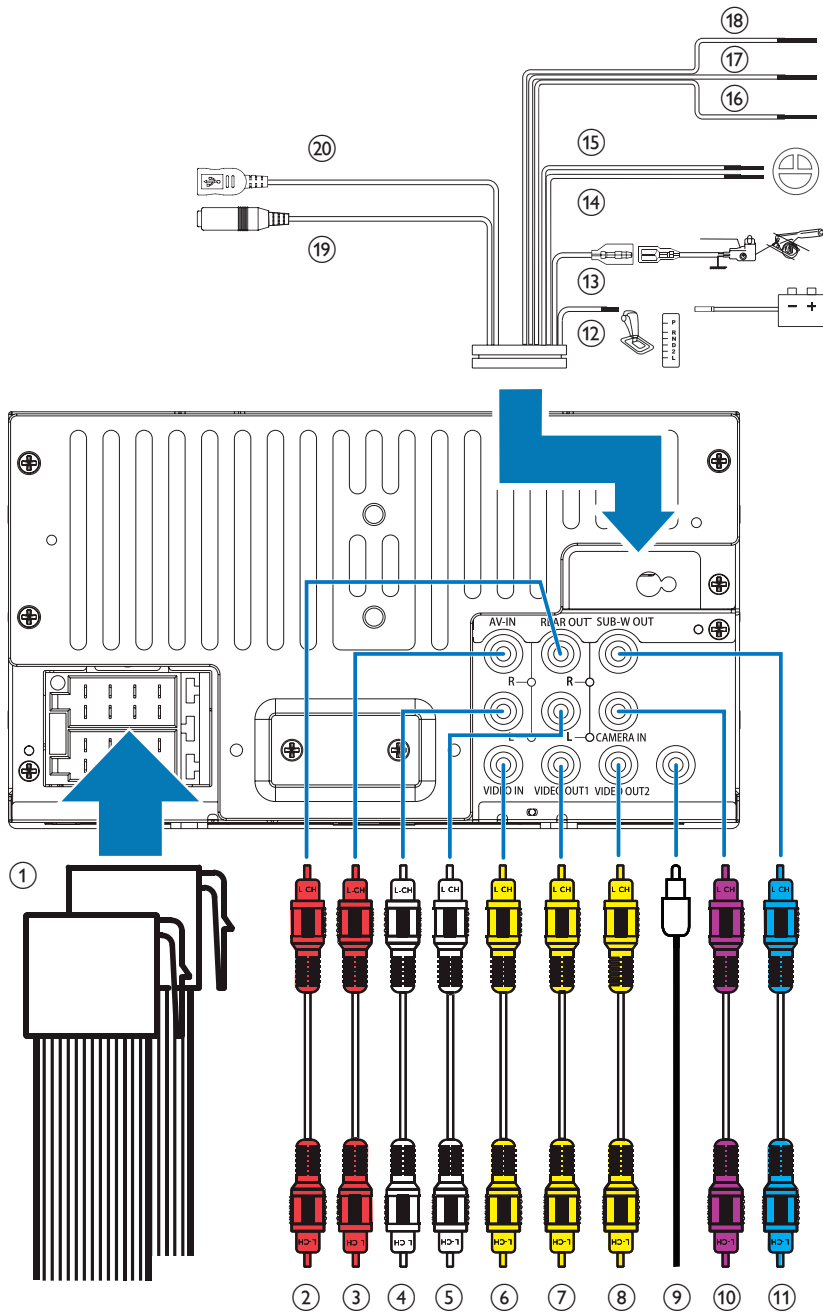

## Mount into the dashboard

### Note

- Make sure that wires are correctly connected before you mount the main unit into a car.
- If preset radio stations are lost when the ignition key is turned OFF and then back ON, reconnect the red leads crosswise to the yellow ones.

- 1 If the car does not have an on-board drive or navigation computer, disconnect the negative terminal of the car battery.
  - If you disconnect the car battery in a car that has an on-board drive or navigation computer, the computer may lose its memory.
  - If the car battery is not disconnected, to avoid short-circuit, make sure that bare wires do not touch each other.
- 2 Make sure that the car dashboard opening is within these measurements:

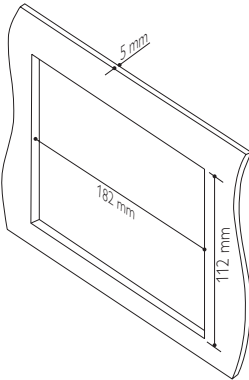

- Since the unit cannot be used if the dashboard opening's slant angle is above 20 degrees, make sure that the horizontal slant of the car dashboard opening is between 0 and 20 degrees.

- 3 Slide the unit into the dashboard until a click sound is heard.

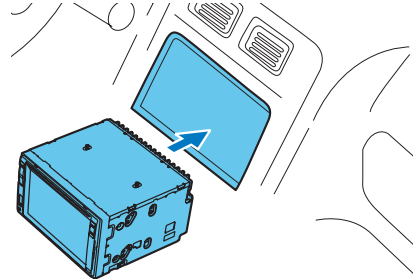

- 4 Reconnect the negative terminal of the car battery.

# 4 Get started

## ! Caution

- Risk of car accidents! Never watch video or operate this system while driving.

## Prepare the remote control

### For the first time use

Pull the protective sheet out.  
↳ The remote control is ready for use.

## Replace the battery

## ! Caution

- Risk of explosion! Keep batteries away from heat, sunshine or fire. Never discard batteries in fire.

## ☰ Note

- Remove the battery if it is exhausted or if the remote control is not to be used for a long time.
- Batteries contain chemical substances, they should be disposed of properly.
- Perchlorate Material - special handling may apply. See [www.dtsc.ca.gov/hazardouswaste/perchlorate](http://www.dtsc.ca.gov/hazardouswaste/perchlorate).

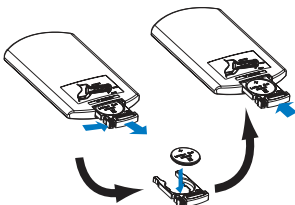

- 1 Pull out the battery tray.
- 2 Insert one CR2025 battery with correct polarity (+/-) as indicated.

- 3 Insert the battery tray.

## Turn on

- Press :
- ↳ PHILIPS logo and a progress bar are displayed while boot-up.
  - To turn off the system, press and hold for 3 seconds.

## For the first time use

After successful boot-up, the following interface is displayed.



- 1 Tap to select a language for on-screen display.  
↳ The following interface is displayed.

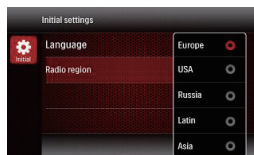

- 2 Tap to select a radio region that matches your location.  
↳ The following interface is displayed.



- 3 Tap **[Finish]** to complete the initial setup.  
↳ The device switches to radio mode automatically.

## Use the home menu

### Note



- If  is displayed when you touch an icon, it indicates that the selected media or feature is unavailable at the current time.

## Access the home menu







Tap  to access the home menu.



- ↳ The clock, date, and the bar for popular icons are displayed.



- To access the full menu with all feature icons displayed, tap .
- To return to the home menu, tap .



-  **[Radio]**: Switch the source to FM/AM radio.
-  **[Disc]**: Switch the source to disc.
-  **[USB]**: Switch the source to USB storage device.
-  **[Navigation]**: Access the navigation system.
-  **[Bluetooth]**: Use the Bluetooth feature.
-  **[AV-In 1]/[AV-In 2]**: Switch the source to the audio and video input that is transferred from an external video player.



-  **[Rear zone]**: Access the settings for rear monitors.
-  **[SWC]**: Access the interface to assign functions to buttons on the steering wheel.
-  **[Settings]**: Access the system menu.

## Customize the home menu



- 1 Tap and hold an icon until it is movable.
- 2 Drag it to the target place, and then release your finger:
  - When you move an icon from the bar for popular icons to the lower area, release your finger when the icon's name is displayed.
  - When you move an icon from the lower area to the bar for popular icons, release your finger when the icon's name disappears.
- 3 Tap  to return to the home menu.
  - ↳ The bar for popular icons is refreshed.

## Set the date and time

- 1 Tap  >  to access the full menu with all feature icons displayed.
- 2 Tap  **[Settings]**.
  - ↳ The **[General]** menu is displayed.

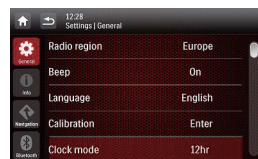

- 3 Tap **[Clock mode]** to select a time format.
  - **[24hr]**: 24-hour time format
  - **[12hr]**: 12-hour time format
- 4 Tap **[Date]** to display the interface for setting the date.

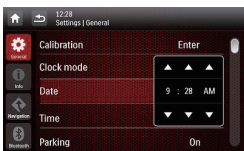

- 5 Tap **▲▼** to set the year, month, and date.
- 6 Tap **[Time]** to display the interface for setting the time.

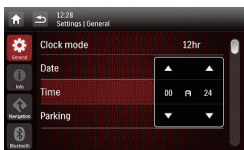

- 7 Tap **▲▼** to set the hour and minute.
- 8 Tap **↶** to return to the home menu.

---

## Adjust the screen brightness

Press and hold **NAVI** on the front panel to select a brightness level of the screen.

- **[LEVEL 1]**, **[LEVEL 2]**, or **[LEVEL 3]**

---

## Switch display designs

Select a preset display design.

- 1 In any mode, tap **☰**, and then **[Display Design]**.
  - ↳ The **[Display Design]** interface is displayed.

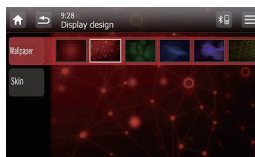

- 2 Tap a setting to display the options.
  - **[Wallpaper]**: Select a wallpaper.
  - **[Skin]**: Select a background color for on-screen icons.
- 3 Tap an option to select it.
- 4 Tap **↶** to return to the previous mode.

# 5 Play from hard media

You can use this system to listen to audio, watch videos, and view photos that are stored on a disc or USB storage device.

## Note

- Before use, check for compatible media.

## Load a disc

### Caution

- Never insert any object other than a disc of 12-cm diameter into the disc slot.

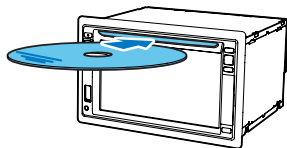

- 1 Insert the disc into the disc slot with the label side facing up.
  - ↳ Play starts automatically.
  - If play does not start automatically, tap the screen to display the ► icon, and then tap ► to start play.
- 2 To eject the disc, press ▲.
  - ↳ When the disc is ejected, the system switches to the previous source or radio mode.

## Region code

This player can play discs with the following region code.

DVD region code

Countries



Latin America

## Connect a USB storage device

### Note

- Make sure that the USB storage device contains compatible files.
- NTFS (New Technology File System) file system is not supported.

- 1 Push the USB socket cover upwards to open it.
- 2 Connect the USB storage device to the USB socket.
  - ↳ Play starts automatically.

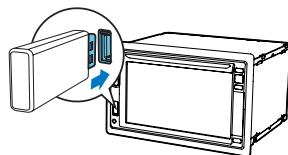

- To remove the USB storage device, switch the system to another source first.



# Control play

## Videos



- : Return to the home menu.
- : Zoom in or out of the image.
- : Select an available audio channel or audio language.
- : Select an available subtitle.
- :
  - For DVD, return to the disc menu or root menu.
  - For recorded files, return to the list of files or folders (see 'Browse recorded files' on page 17).
- **PBC**: For VCD/SVCD only, enable or disable the PBC (Playback Control) feature.
- / : Skip to the previous or next title, chapter, track, or file.
  - To search forward fast or rewind the track, tap on the progress bar:
- / : Start, pause, or resume play.
- : Display control icons on the second page.

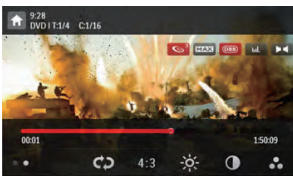

- : Select a repeat mode.
  - DVD: **[Repeat chapter]** (repeat the current chapter), **[Repeat title]** (repeat the current title), **[Repeat all]** (repeat all chapters and titles), or **[Repeat off]** (cancel repeat play).

- VCD/SVCD: **[Repeat one]** (repeat the current track) or **[Repeat all]** (repeat all tracks).
- Recorded files: **[Repeat one]** (repeat the current video file), **[Repeat folder]** (repeat all video files in the current folder), or **[Repeat all]** (repeat all video files).
- **[16:9]/[4:3]**: Select an aspect ratio.
- : Tap to display the brightness bar, and then tap on the bar to adjust the screen brightness.
- : Tap to display the contrast bar, and then tap on the bar to adjust the image contrast.
- : Tap to display the saturation bar, and then tap on the bar to adjust the image saturation.
- : Display control icons on the first page.

## Audios



- : Return to the home menu.
- :
  - Press once to access the track list.
  - Press twice to access the folder list.
  - Press repeatedly to return to the playback interface.
- : For recorded files only, skip to the next audio folder.
- : Return to the list of tracks or folders (see 'Browse recorded files' on page 17).
- / : Skip to the previous or next track.
  - To search forward fast or rewind the track, tap on the progress bar:
- / : Start, pause, or resume play.
- / / : Select a repeat mode.
  - : Repeat the current track.

- : For recorded files, repeat all tracks in the current folder.
- (highlighted): Repeat all tracks.
- : Select random play ( highlighted) or sequential play ( in gray).

## Pictures

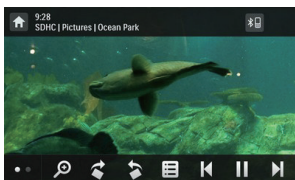

- : Return to the home menu.
- : Zoom in or out of the picture.
- : Rotate the picture clockwise or anti-clockwise by 90 degrees.
- / : Return to the list of files or folders (see 'Browse recorded files' on page 17).
- / : Select the previous or next picture.
- / : Pause or resume the slideshow.
- : Display control icons on the second page.

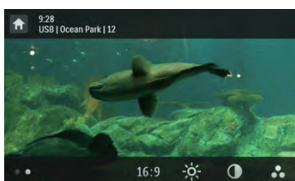

- **[16:9]/[4:3]**: Select an aspect ratio.
- : Tap to display the brightness bar, and then tap on the bar to adjust the screen brightness.
- : Tap to display the contrast bar, and then tap on the bar to adjust the image contrast.
- : Tap to display the saturation bar, and tap on the bar to adjust the image saturation.
- : Display control icons on the first page.

## Browse recorded files

During playing recorded files, you can access the file list and select files from the list.

- 1 Tap to access the list of files or folders.

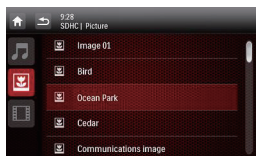

- 2 Tap an icon to select a file category.
  - : Display the list of audio tracks or folders.
  - : Display the list of picture files or folders.
  - : Display the list of video files or folders.
- 3 Tap the name of a file to start play.

# 6 Listen to radio

## Switch to radio mode

After the boot-up at the first time, the system switches to radio mode automatically.

To switch the source back to radio afterwards, tap  **[Radio]** on the home menu.

↳ The interface for radio is displayed.



## Set up

Before you search for radio stations, make prior setup.

Tap  to display the setup menus.

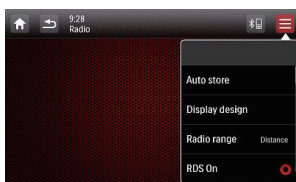

## Select a radio range

1 Tap **[Radio Range]**.

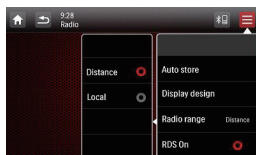

2 Tap **[Distance]** or **[Local]** to select a tuner sensitivity.

- **[Distance]**: Stations with strong and weak signals can be tuned to.
- **[Local]**: Only stations with strong signals can be tuned to.

## Tune to a radio station



1 Tap **FM** or **AM** to select a band.

- FM bands: **FM1, FM2, FM3**
- AM bands: **AM1, AM2**

2 Tap **<** or **>** repeatedly until the frequency of target radio station is displayed.

- To tune to a radio station automatically, tap and hold **<** or **>** until the frequency digits start change.



Tip

- You can also press **BAND** on the remote control repeatedly to select a band.

## Store radio stations in memory

You can store up to 6 stations in each band.

## Store radio stations manually

1 Select a band.

2 Tune to the target radio station.

3 Tap and hold one of the channels (**1** to **6**) over two seconds.

↳ The radio station is saved under the selected channel.

---

## Store radio stations automatically

You can search for a radio station with intro search, which broadcasts a 10-second preview of each detected radio station.

- 1 Select a band.
- 2 Tap 
- 3 Tap **[Auto Store]**.  
↳ Auto search starts. The six strongest stations of the selected band are saved in preset channels automatically.

---

## Tune to a preset radio station

- 1 Select a band.
- 2 Tap one of the preset channels (1 to 6) to select a preset radio station.



# 7 Use the navigation system

 **Note**

- The navigation function requires a special antenna module and map card to work with but they are not bundled nor offered in Latin America countries at this time.

---

## Insert the map data card

 **Note**

- The map data card is not included in the packaging.
- Before using the map data card, update the map data if necessary.

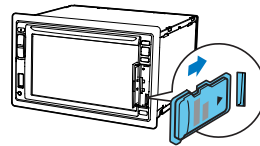

- 1 Flip up the protective cover.
- 2 Insert the map data card into the **MAP** slot until you hear a "click".
- 3 Close the protective cover.

---

## Navigate your road trip

### Note

- Risk of traffic accident! Never operate the navigation system during drive. Complete the setting of your destination and other navigation specifications before you drive.



- 1 Press **NAVI**.
  - You can also tap  on the home menu to access the navigation system.
  - ↳ The navigation interface is displayed in a few seconds.
- 2 Follow the user manual of the navigation map to set navigation specifications.

## 8 Use Bluetooth devices

With this system, you can listen to audio from a player and make a call through Bluetooth.

---

### Activate the Bluetooth function

- On the home menu, tap .
- In any other mode, tap  on top of the screen.

---

### Pair a device

#### Note

- Philips does not guarantee the compatibility with all Bluetooth devices.
- Before pairing a device with this system, read its user manual for Bluetooth compatibility.
- Make sure that Bluetooth function is enabled on your device, and your device is set as visible to all other Bluetooth devices.
- The operational range between this system and a Bluetooth device is approximately 8 meters (24 feet).
- Any obstacle between this system and a Bluetooth device can reduce the operational range.
- Keep away from any other electronic device that may cause interference.

---

### Pair the first device

- 1 Activate the Bluetooth function on this system.
  - ↳ The following interface is displayed.

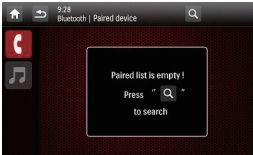

- 2 Tap  on this system to search for other Bluetooth devices.

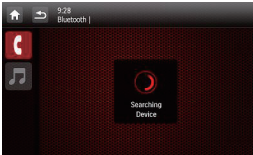

- 3 In the device list, tap the name of your Bluetooth device, and then tap  behind the name.

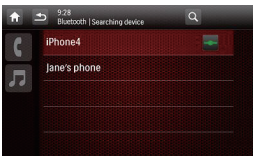





↳ The pairing starts, and then a pairing request from CED1800BT is displayed on your device.

- 4 On your device, accept the pairing request from CED1800BT, enter the default password '0000', and then confirm the password entry.





↳ [Paired OK!] flashes, and then [Connecting] is displayed on this system.

- 5 On your device, enable or permit the connection with CED1800BT.
  - If a player is connected, the music playback interface is displayed on this system.



-  : Tap it to return to the music playback interface.
  -  : Tap it to display the list of paired mobile phones.
  -  : Tap it to display the list of paired mobile phones.
  -  : Tap it to display the list of paired mobile phones.
- If a mobile phone is connected, the keypad is displayed on this system.



-  : Tap it to display the list of paired players.
-  : Tap it to display the on-screen keypad for phone calls.
-  : Tap it to display the phone book that is synchronized with your mobile phone and keypad.
-  : Tap it to display the list of favorite contacts.

## Pair more devices

- 1 Activate the Bluetooth function on this system.
  - ↳ One of the following interfaces is displayed.

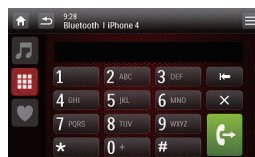

- 2 Tap  on the top right corner.

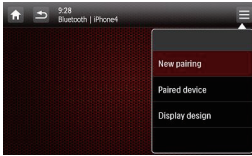

- 3 Tap **[New pairing]** to start searching for Bluetooth devices.
- 4 Repeat steps 3 to 5 that are indicated in the above section "Pair the first device" (see "Pair the first device" on page 21)" to complete the connection.

### Note

- You can connect a music player and a mobile phone simultaneously.

## Manage paired devices

- 1 Activate the Bluetooth function.
- 2 Tap or .
  - To manage paired players, tap .
  - To manage paired mobile phones, tap .
- 3 Tap on the top right corner.

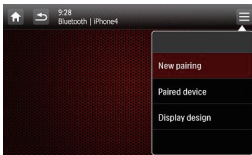

- 4 Tap **[Paired Device]**.  
 The list of paired devices is displayed.

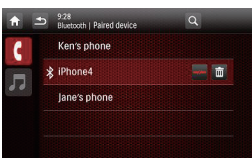

- 5 Tap the name of the paired device that you want to reconnect, disconnect, or delete.

- : Tap to reconnect the device.
- : Tap to disconnect the device.
- : Tap to delete the device from the list of paired devices.

- 6 Tap , , or .

### Tip

- If you want to manually reconnect a device after the connection is interrupted, disable the function of automatic connection (see "Adjust Bluetooth settings" on page 28).

## Play audio from a connected device

If the connected Bluetooth device supports Advanced Audio Distribution Profile (A2DP), you can listen to tracks that are stored on the device through the system. If the device also supports Audio Video Remote Control Profile (AVRCP) profile, you can control play on the system or with its remote control.

- 1 Play a track on the connected device.
- 2 On this system, tap to display the music playback interface.



- 3 Tap icons on the interface to control play.
  - : Pause or resume play.
  - / : Select the previous or next track.

### Note

- If the connected device does not support the AVRCP profile, control play on the connected device.

## Make a call

### Note

- Keep the Bluetooth connection active between the system and your mobile phone.

## Locate the external microphone

You can connect an external microphone for better communication quality.

### Note

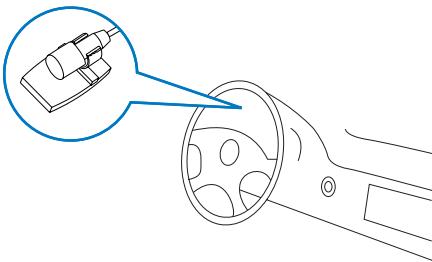

- The external microphone is not included in the packaging of this system.

- 1 Make sure that the microphone is connected to this system (see 'Connect wires' on page 7).
- 2 Place the microphone at a proper location, such as, stick it onto the dashboard, or clip it on the sun-shield.









## Call a number



You can make phone calls with the system.

- 1 Tap  on top of the screen.  
↳ The keypad is displayed.
  - If the keypad is not displayed, tap .



- 2 Tap number icons to enter the phone number:
  - To clear the last digit, tap .
  - To clear all digits, tap .
  - To return to the previous screen, tap .
- 3 Tap  to send the call.
  - To end the call, tap .
  - To enter numbers during the call, tap  to display the keypad first.

## Redial the last called number

- 1 Tap .  
↳ The last called number is displayed.
- 2 Tap  again to send the call.



## Answer a call

### Note

- By default, all incoming calls are picked up automatically. You can disable the function of automatic answer (see 'Adjust Bluetooth settings' on page 28).

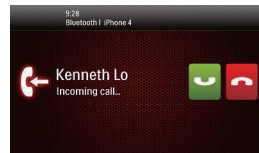
- 1 When there is an incoming call, **[Incoming call...]** is displayed on the screen.



- 2 Tap  to answer the call.
  - To reject or end the call, tap .



---

## Transfer a phone call to mobile phone

By default, the voice comes from the loudspeakers during a call.





- 1 Tap  to transfer the phone call to your mobile phone.
  - ↳ The loudspeakers are muted, and the voice comes from the mobile phone only.
- 2 Take up your mobile phone for the conversation.

---

## Edit the favorite call list

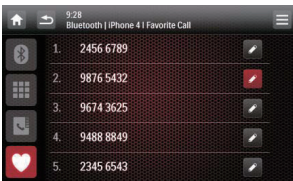
Save the number of a contact into the favorite call list, and then you can send a call quickly.



- 1 Tap  to display the favorite call list.
- 2 Tap  behind a sequence number.
- 3 Enter the number and then tap **OK** to confirm.
  - ↳ The number is saved.
    - To send a call, tap the number from the list.

# 9 Adjust sound

When you listen to radio, enjoy music, or watch video, follow the instructions below to adjust sound.

---

## Adjust the volume level

Press **+/-** repeatedly on the front panel.

- **+**: Increase the volume level.
- **-**: Decrease the volume level.

---

## Mute sound

Press  on the front panel.

- To release the speakers from mute status, press  again.

---

## Enable the MAX Sound feature

Tap **MAX** on the playback interface.



- **MAX** (highlighted): The **MAX Sound** feature is enabled.
- **MAX** (in gray): The **MAX Sound** feature is disabled.

---

## Enable the DBB sound effect

When DBB (Dynamic Bass Boost) is enabled, low tones are enhanced electronically.

Tap  on the playback interface.

-  (highlighted): DBB sound effect is enabled.
-  (in gray): DBB sound effect is disabled.

## Enable the FullSound effect

### Note



- This feature is unavailable when you listen to radio.

Philips FullSound restores the audio details that are lost due to compression. It enriches the music signals so that what you hear is the full sound with every nuance of emotion and every detail of musical genius.

Philips FullSound can:

- bring out CD sound quality from an MP3 track,
- achieve richer bass with greater depth and impact,
- restore the sense of spaciousness that lacks in a compressed audio, and
- enhance sound precision and details.

Tap  on the playback interface.

-  (highlighted): The FullSound effect is enabled.
-  (in gray): The FullSound effect is disabled.

## Select a preset sound equalizer

- Tap  on the playback interface.  
↳ The current equalizer settings are displayed.





- Tap < or > to select a preset sound equalizer.
  - [Custom], [Techno], [Rock], [Classic], [Jazz], [Optimal], [Flat], or [Pop]
- ↳ The selected sound equalizer is highlighted.

- Tap on the circle or bar to adjust the settings.
  - [Bass]: bass range (-14 to +14)
  - [Middle]: middle range (-14 to +14)
  - [Treble]: treble range (-14 to +14)
  - [LPF]: low pass filter range (60 Hz, 80 Hz, 100 Hz, or 160 Hz)
  - [MPF]: middle pass filter range (0.5 kHz, 1.0 kHz, 1.5 kHz, or 2.5 kHz)
  - [HPF]: high pass filter range (10.0 kHz, 12.5 kHz, 15.0 kHz, or 17.5 kHz)
  - ↻: Tap and hold to restore the settings.
- Tap  to exit.

## Others

- Tap  on the playback interface.  
↳ The setup interface is displayed.



- : Tap to display the [Music zone] interface for selecting a listening zone.
- : Tap to display the [Fader/Balance] interface for adjusting the fader and balance.
- : Tap to display the [SubWoofer] interface for setting the sub-woofer.

## Adjust the fader and balance



- Tap + or - to adjust fader or balance value.
- [Fader]: fader range (+16 to -16).
  - [Balance]: balance range (-16 to +16).

## Set the sub-woofer



- **[On]/[Off]**: Tap to turn on or off the sub-woofer.
- **+ / -**: Tap to set the volume of sub-woofer (0 dB to 14 dB).
- **[80 Hz]/[120 Hz]/[160 Hz]**: Tap to select a low pass filter range for the sub-woofer.

## Select a listening zone

Philips' innovative Zone technology enables the driver or passengers to enjoy music with the best speakers balance and experience more vivid spacial effect as the artist is intended to create. You can switch the music listening zone from the driver to passengers for the best speaker sound settings in car.

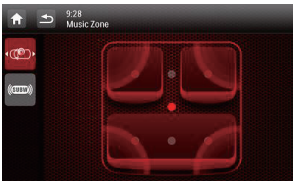

Tap a gray point to switch the listening zone.

- ↳ The highlighted area indicates the current listening zone.

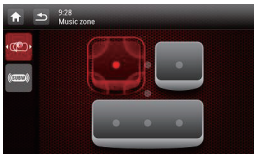

# 10 Adjust settings

## Access system setup menus

- 1 Tap **🏠** > **▲** to display all feature icons.



- 2 Tap **⚙️** **[Settings]**.  
↳ The **[General]** menu is displayed.

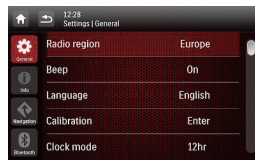

- 3 Tap an icon on the left.
  - **⚙️**: Access the **[General]** menu to adjust general settings.
  - **ℹ️**: Access the **[Info]** menu to view system information.
  - **📍**: Access the **[Navigation]** menu to adjust navigation settings.
  - **📶**: Access the **[Bluetooth]** menu to adjust Bluetooth settings.
- 4 Swipe your finger up or down to view more settings.
- 5 Tap an option to view details or change the setting.
  - To exit the menu, tap **🏠**.

## Adjust general settings



Settings	Options	Description
[Radio Region]		Select a radio region that matches your location.
[Beep]	[On]	Turn the beep sound on. Each time you press a button or tap an icon, the unit beeps.
	[Off]	Turn off the beep sound.
[Language]		Select an OSD (on-screen display) language.
[Calibration]		Follow the on-screen instructions to calibrate the touch screen.
[Clock mode]	[12Hr]/[24Hr]	Select a time format.
[Date]		Set the date.
[Time]		Set the time.
[Parking]	[On]/[Off]	Enable or disable the video blocking system.

[Demo] (Auto start after power off)	[On]/[Off]	Enable it to demonstrate features after the system is power off.
-------------------------------------	------------	--

## View system information



Settings	Options
[ARM version]	View firmware versions.
[Servo version]	
[MCU version]	
[Bluetooth version]	View the version of Bluetooth.
[DVD regions]	View the DVD region code that the system supports.
[Restore factory defaults]	Tap to display the dialog box for restoring the system. <ul style="list-style-type: none"> <li>Tap [Yes] to restore the system to factory default status.</li> <li>Tap [No] to return to the previous menu.</li> </ul>

## Adjust Navigation settings

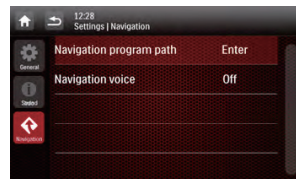

- **[Navigation Program Path]:** Tap **[Enter]** to access the Navigation Program Path mode.
- **[Navigation Voice]:** Tap **[Enter]** to display the **[Navigation Voice]** interface.



- **[All]/[Front left]/[Front right]:** Select a zone for navigation voice.
- **[Off]:** Mute the navigation voice.
- **[Voice Level]:** Tap **+/-** to adjust the volume of navigation voice.

<b>[Pin Code]</b>		Set the password for pairing the car entertainment system with another Bluetooth device. The default password is <b>0000</b> .
<b>[External microphone]</b>	<b>[On]</b>	Turn on the external microphone.
	<b>[Off]</b>	Use the integrated microphone.

## Adjust Bluetooth settings

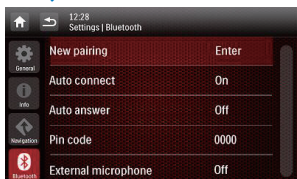

Bluetooth settings	Options	Description
<b>[New Pairing]</b>		Search for new devices.
<b>[Auto Connect]</b>	<b>[On]</b>	When a paired device is within effective range, the system reconnects with the device automatically.
	<b>[Off]</b>	Reconnect manually.
<b>[Auto Answer]</b>	<b>[On]</b>	Answer phone calls automatically when the paired mobile phone receives an incoming call.
	<b>[Off]</b>	Answer phone calls manually.

# 11 Others

## Play external audio/video input

You can connect an external audio/video player to this system.

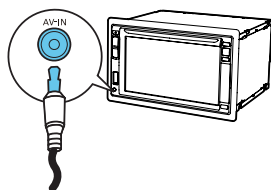

- 1 Connect a composite AV cable to
  - the **AV-IN** socket on the front panel, and
  - the audio and video output sockets of the external player.
- 2 Tap **⏠** > **▲** to access the full menu with all feature icons displayed.
- 3 Tap **⏏** **[AV-IN1]** to display the playback interface.
- 4 Operate on the external player to start play (see the user manual of the external device).

### Tip

- If you connect this system to an external player through the **VIDEO IN**, **AV-IN L**, and **AV-IN R** sockets on the rear panel, tap **⏏** **[AV-IN2]** to switch the source instead of **⏏** **[AV-IN1]**.

## Use rear monitors

If one or two monitors are connected for backseat passengers, you can select different sources for front and backseat passengers.

### Note

- Make sure that rear monitors are correctly connected to this system.
- Only when the multi-zone display mode is activated, rear monitors can receive signals from the system.
- By default, the same signals are transferred to the front and rear monitors.
- When a disc or USB storage device is selected as the source for front zone, you cannot select another source for rear zone.
- Only when the system is in radio mode, navigation mode, or Bluetooth mode, you can select a source for rear zone from disc or USB storage device.

- 1 Tap **⏠** > **▲** to access the full menu with all feature icons displayed.
- 2 Tap **⏏**.  
↳ The **[Rear Zone]** menu is displayed.

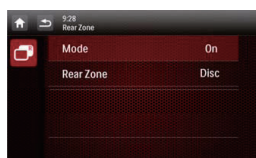



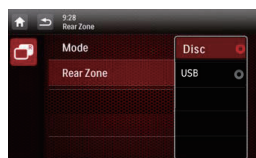

- 3 Tap **[Mode]** to enable or disable the signal transferring to rear monitors.
  - **[On]**: Enable the signal transferring to rear monitors.
  - **[Off]**: Disable the signal transferring to rear monitors.↳ When it is enabled, the following interface is displayed.



- 4 Tap to select an available source to start play.
- 5 Tap  to return to the previous mode.



## Switch the control interfaces

When different sources are selected for front passengers and backseat passengers, you can tap  to switch the control interface for front source or rear source.

- ↳ When  is solidly displayed, the current control interface is for the front source.
- ↳ When  blinks with  and **[Rear zone]** displayed, the current control interface is for the rear source.

## Use buttons on the steering wheel

You can assign a function to a button on the steering wheel, and then control the system with that button.

- 1 Tap  >  to access the full menu with all feature icons displayed.
- 2 Tap .
  - ↳ The **[Steering Wheel Remote Control Learning]** interface is displayed.



- 3 Tap an icon, for example, , of which you want to assign the function to a button on the steering wheel.





- To cancel the assignment, tap **[Cancel]**.
- 4 Press and hold the button on the steering wheel for one second.
    - ↳ The following interface is displayed.



- 5 Repeat steps 3 and 4 to assign more functions to buttons on the steering wheel.
  - To clear the assignment, tap **[Clear All]**.

## Set the rear view camera

If a rear view camera is connected, you can view on the screen what the camera takes.

- 1 Tap  >  to access the full menu with all feature icons displayed.
- 2 Tap .
  - ↳ Picture from rear camera is displayed.

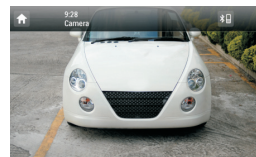

## Reset the system

If the system hangs up, reset it.

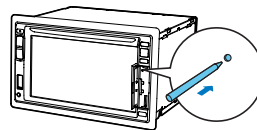

- 1 Flip up the protective cover.
- 2 Press **RESET** with the tip of a ball-point pen or toothpick.

---

## Replace the fuse

If there is no power, check the fuse and replace it if it is damaged.

- 1 Detach the main unit from dashboard.
- 2 Check the electric connection.
- 3 Remove the damaged fuse from the rear panel.
- 4 Insert a new fuse with the same specifications (15 A).

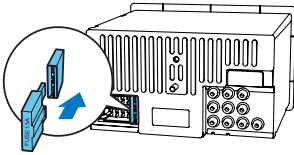

### Tip

- If the fuse gets damaged immediately after it is replaced, an internal malfunction may occur. In this case, consult your Philips retailer.

---

## Upgrade the firmware

### Note

- Power supply must not be interrupted during the upgrade.
- When the firmware upgrade succeeds, all settings are restored to the factory default status.

---

## Register your product

- 1 Go to [www.philips.com/welcome](http://www.philips.com/welcome).
- 2 Click the link of "**Register my product**" (the exact wording of this link name may vary in different languages).
- 3 Log in with your account on the prompt Web page.

- If you have no account for Club Philips, create one first on this Web page.

- 4 Search your product with "**CED1800BT/55**" as the keyword.
- 5 Click the link of search result to access the Web page for registering your product.
- 6 Fill in necessary information about this product to complete the registration.
  - ↳ With the registration, you can get information about software update and product support at this Web page or via your mailbox that is registered as the account for Club Philips.

---

## Perform the upgrade

- 1 Check the current firmware version of this system (see 'View system information' on page 28).
- 2 Go to [www.philips.com/support](http://www.philips.com/support).
- 3 Login with your account for Club Philips.
  - ↳ Support information about your registered product is displayed.
- 4 Click the link of "**Firmware Upgrade Readme File**" (the exact wording of this link name may vary in different languages).
- 5 Read and understand the instructions on firmware upgrade.
- 6 Follow the instructions to download the upgrade packet and complete the upgrade.
  - If the upgrade fails, reboot this system, and then perform the upgrade again.



# 12 Product information

## Note

- Product information is subject to change without prior notice.

## General

Power supply	12 V DC (11 V - 16 V), negative ground
Fuse	15 A
Suitable speaker impedance	4 - 8 $\Omega$
Maximum power output	50 W $\times$ 4 channels
Continuous power output	20 W $\times$ 4 channels (4 $\Omega$ 10% T.H.D.)
Pre-Amp output voltage	2.5 V (CD play mode; 1 kHz, 0 dB, 10 k $\Omega$ load)
Sub-woofer output voltage	2.5 V (CD play mode, 61 Hz, 0 dB, 10 k $\Omega$ load)
Aux-in level	$\geq$ 800 mV
Dimensions (W $\times$ H $\times$ D)	178 $\times$ 101.5 $\times$ 160 mm
Weight (main unit)	1.9 kg

## Disc player

System	DVD / CD audio / MP3 system
Disc diameter	12 cm
Frequency response	20 Hz - 20 kHz
Signal/noise ratio	> 75 dB
Total harmonic distortion	Less than 0.3%
Channel separation	> 55 dB
Video signal format	NTSC/PAL
Video output	1 +/- 0.2 V p-p

## Radio

Frequency range - FM	87.5 - 108.0 MHz (50 kHz per step)
Frequency range - AM(MW)	530 - 1710 kHz (9 kHz per step)
Usable sensitivity - FM	2 $\mu$ V
Usable sensitivity - AM (MW)	25 $\mu$ V

## LCD

Screen size	6.2 inches
Display resolution	800 $\times$ 480 dots
Contrast ratio	500
Brightness	450 cd/m <sup>2</sup>

## Bluetooth

Communication system	Bluetooth Standard version 2.0
Output	Bluetooth Standard Power Class 2
Maximum communication range	Line of sight approx. 8m
Frequency band	2.4 GHz band (2.4000 GHz - 2.4835 GHz)
Compatible Bluetooth profiles	Hands-Free Profile (HFP) Handset Profile (HSP) Advanced Audio Distribution Profile (A2DP) Audio Video Remote Control Profile (AVRCP)
Supported codecs	SBC (Sub Band Codec)
Receive	SBC (Sub Band Codec)
Transmit	SBC (Sub Band Codec)

# 13 Troubleshooting



## Warning

- Never remove the casing of this product.

To keep the warranty valid, never try to repair the product yourself.

If you encounter problems when using this product, check the following points before requesting service. If the problem remains unsolved, go to the Philips Web page ([www.philips.com/support](http://www.philips.com/support)). When you contact Philips, make sure that the product is nearby and the model number and serial number are available.

---

## General

### No power

- Car engine has not been started. Start the car engine.
- Connections are incorrect.
- The fuse has been damaged. Replace the fuse.

### No sound

- Volume is too low. adjust the volume.
- Speaker connections are incorrect.

### No response to the remote control

- Make sure that the path between the remote control and the unit is clear from obstacles.
- Move the remote control close to the unit, and point it at the iR sensor.
- The function is not applicable to the current media.
- Replace the remote control battery.

### The disc does not play.

- The disc is upside down. Make sure that the printed side is upwards.

- The disc is dirty. Clean the disc with a clean, soft, lint-free cloth. Wipe the disc outwards from the center.
- The disc is defective. Try another disc.
- The disc is incompatible. Try another disc.
- The recordable disc is not finalized.
- The region code of DVD disc is not supported. Use a disc with proper region code.

### No image

- Parking wire connection is incorrect. Check the wiring.

### No image on rear monitor

- Enable the signal transferring to rear monitors (see 'Use rear monitors' on page 30).

### Image flashes or is distorted.

- Video connection is improper. Check the connections.

### Noise in broadcasts

- Signals are too weak. Select another station with stronger signals.
- Check the connection of the car antenna.

### Preset stations are lost.

- Battery cable is not correctly connected. Connect the battery cable to the terminal that is always live.

### The fuse is broken.

- The fuse type is incorrect. Replace it with a 15 A fuse.
- Speaker wire or power wire is grounded. Check the connections.

# 14 Notice

Any changes or modifications made to this device that are not expressly approved by WOOX Innovations may void the user's authority to operate the equipment.

---

## Compliance

This apparatus includes this label:

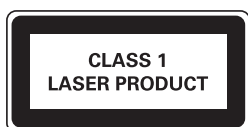

---

## Care of the environment



Your product is designed and manufactured with high quality materials and components, which can be recycled and reused.

Never dispose of your product with other household waste. Please inform yourself about the local rules on the separate collection of electrical and electronic products and batteries. The correct disposal of these products helps prevent potentially negative consequences on the environment and human health.

Your product contains batteries, which cannot be disposed of with normal household waste.

Please inform yourself about the local rules on separate collection of batteries. The correct disposal of batteries helps prevent potentially negative consequences on the environment and human health.

Please visit [www.recycle.philips.com](http://www.recycle.philips.com) for additional information on a recycling center in your area.

## Environmental information

All unnecessary packaging has been omitted. We have tried to make the packaging easy to separate into three materials: cardboard (box), polystyrene foam (buffer) and polyethylene (bags, protective foam sheet.)

Your system consists of materials which can be recycled and reused if disassembled by a specialized company. Please observe the local regulations regarding the disposal of packaging materials, exhausted batteries and old equipment.

---

## Trademark notice

### Bluetooth

The Bluetooth® word mark and logos are registered trademarks owned by Bluetooth SIG, Inc. and any use of such marks by WOOX Innovations is under license.



Windows Media and the Windows logo are trademarks, or registered trademarks of Microsoft Corporation in the United States and/or other countries.



Manufactured under license from Dolby Laboratories. Dolby and the double-D symbol are trademarks of Dolby Laboratories.



'DVD Video' is a trademark of DVD Format/ Logo Licensing Corporation.

Other trademarks and trade names are those of their respective owners.

---

## Copyright



Be responsible  
Respect copyrights

This item incorporates copy protection technology that is protected by U.S. patents and other intellectual property rights of Rovi Corporation. Reverse engineering and disassembly are prohibited.

2014 © WOOX Innovations Limited. All rights reserved.

Specifications are subject to change without notice. WOOX reserves the right to change products at any time without being obliged to adjust earlier supplies accordingly.









Specifications are subject to change without notice

2014 © WOOX Innovations Limited. All rights reserved.

This product was brought to the market by WOOX Innovations Limited or one of its affiliates, further referred to in this document as WOOX Innovations, and is the manufacturer of the product. WOOX Innovations is the warrantor in relation to the product with which this booklet was packaged. Philips and the Philips Shield Emblem are registered trademarks of Koninklijke Philips N.V."

