

Register your product and get support at
www.philips.com/welcome

Immersive

5000 series



Quick start guide

PHILIPS



EN Before using your product, read all accompanying safety information

ES Antes de usar el producto, consulte la información de seguridad que se encuentra adjunta

PT Antes de usar o produto, leia todas as informações de segurança em anexo



EN What's in the box

ES Contenido de la caja

PT Conteúdo da embalagem

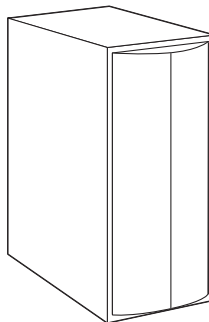
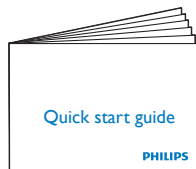
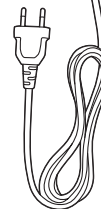
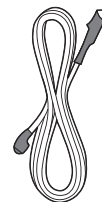
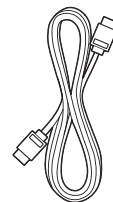
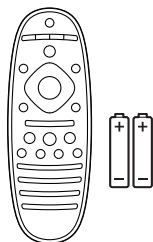
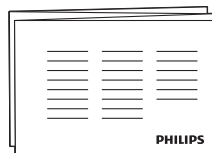

1

EN Position the speakers

ES Ubicación de los altavoces

PT Posicionar as caixas acústicas

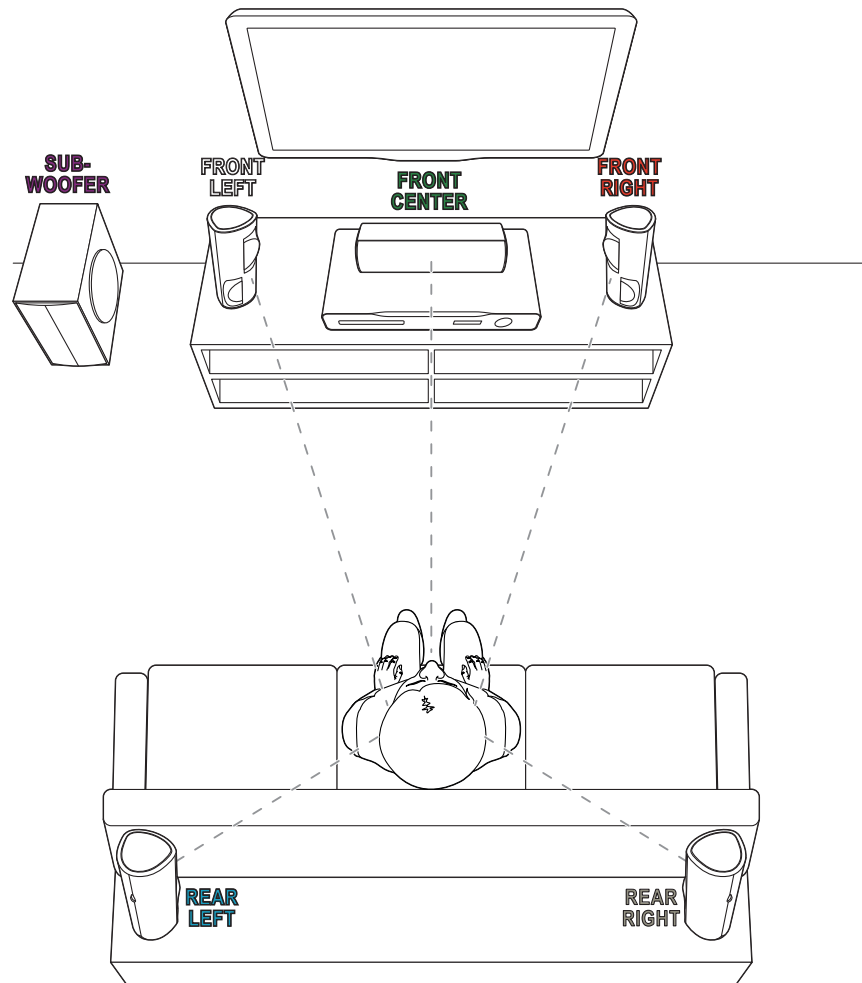

2

- EN** Connect the home theater
- ES** Conexión del Home Theater
- PT** Conectar o Home Theater

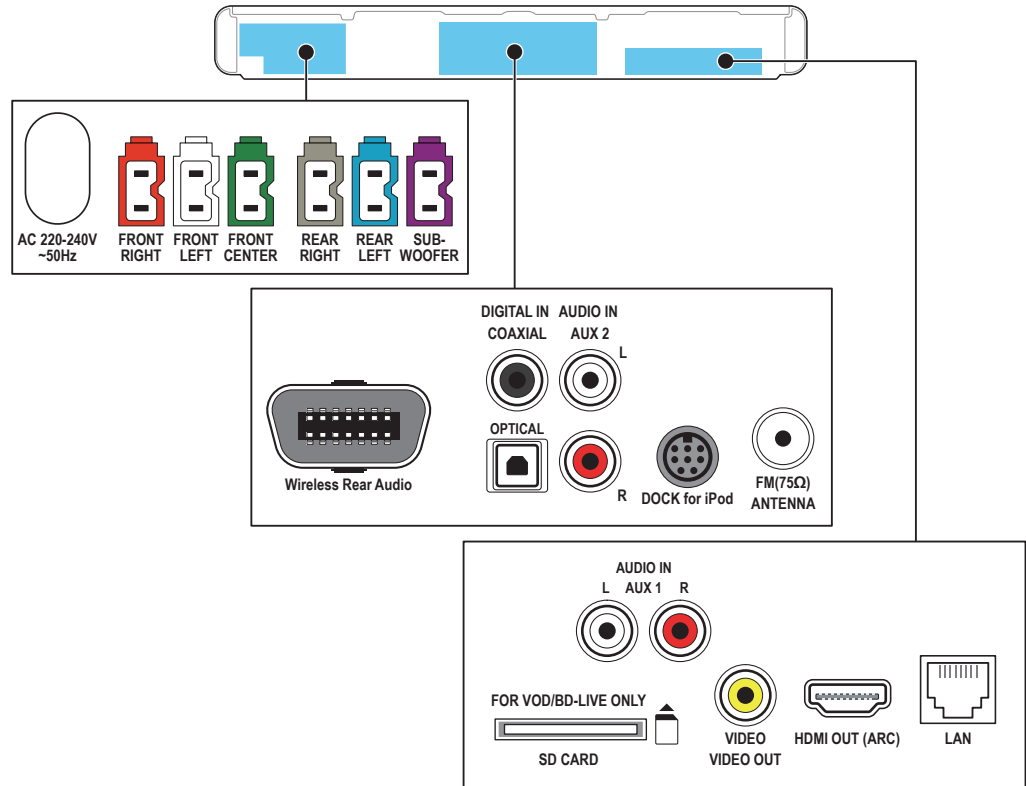

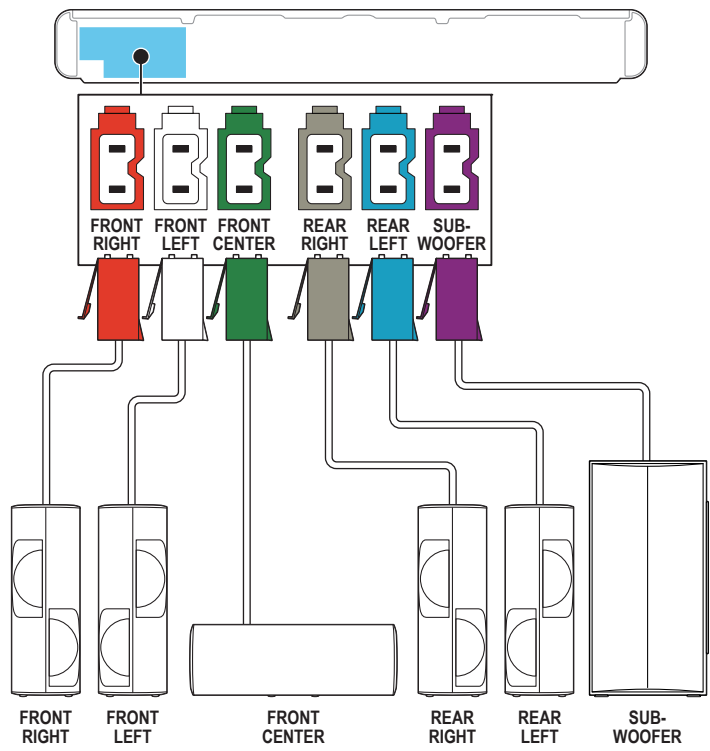

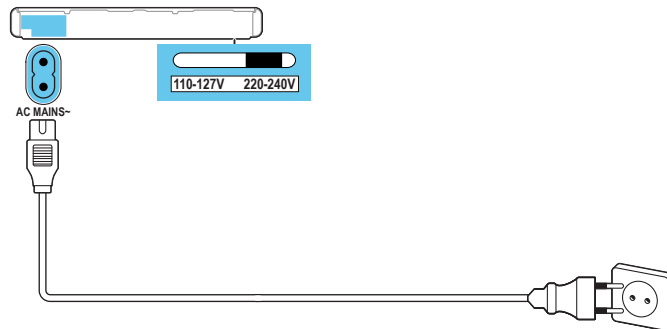
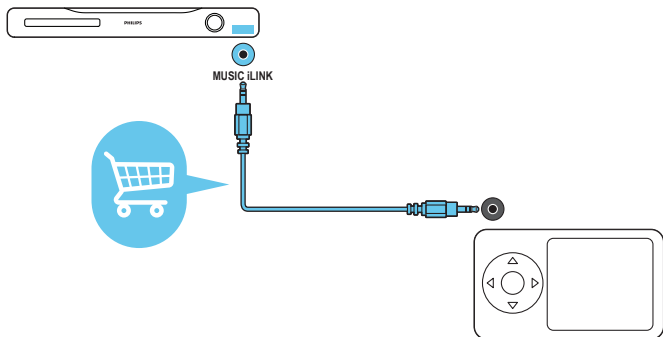
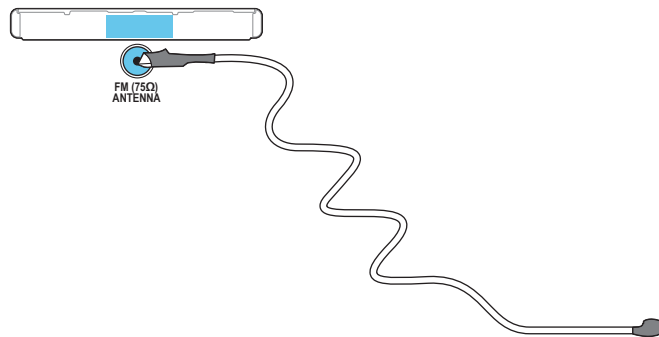
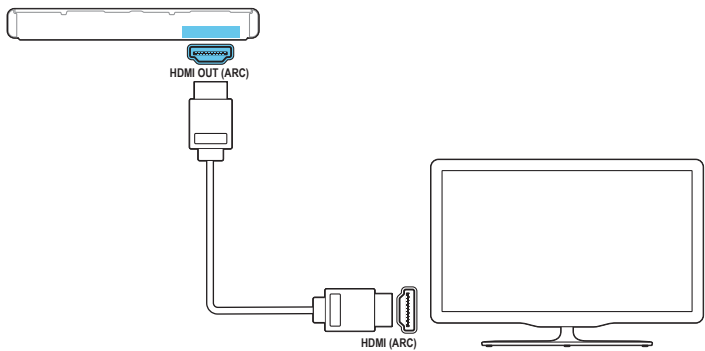

3

- EN** Switch on the home theater
- ES** Encendido del Home Theater
- PT** Ligar o Home Theater

1

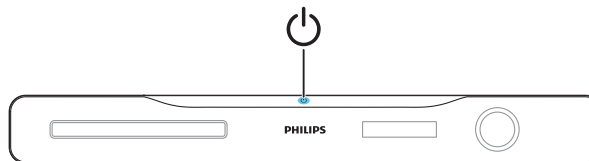

2

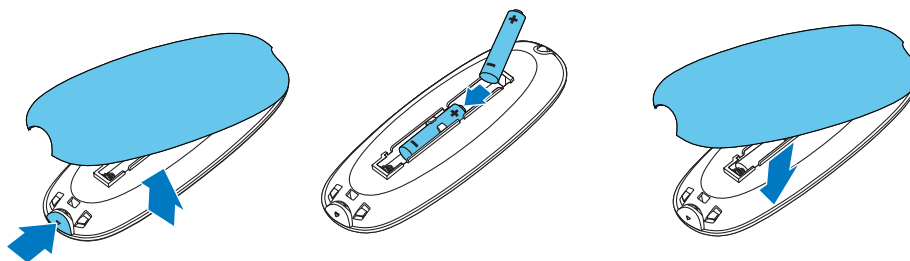



- EN** Complete the first time setup
- ES** Proceso de configuración inicial
- PT** Fazer a configuração inicial

1

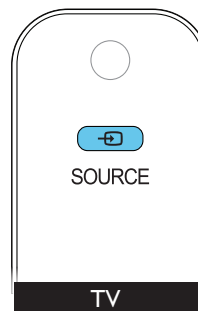
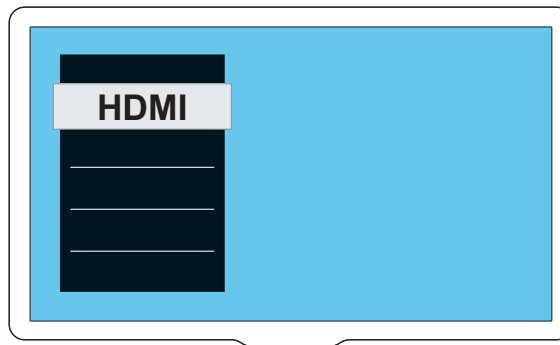

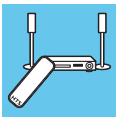

2

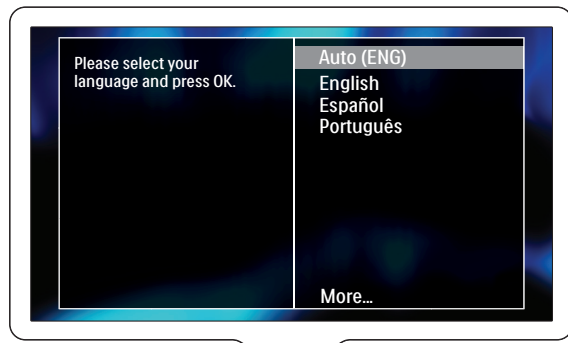

3

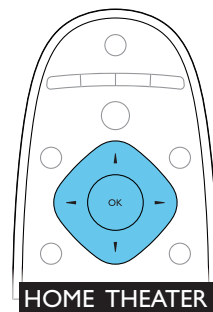
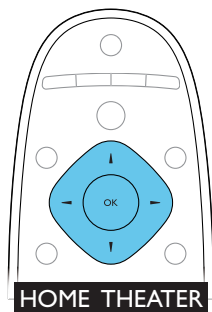
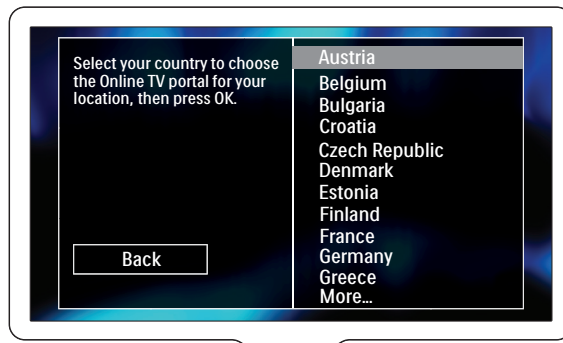

5

EN Use your home theater

ES Uso del sistema de Home Theater

PT Usar o Home Theater

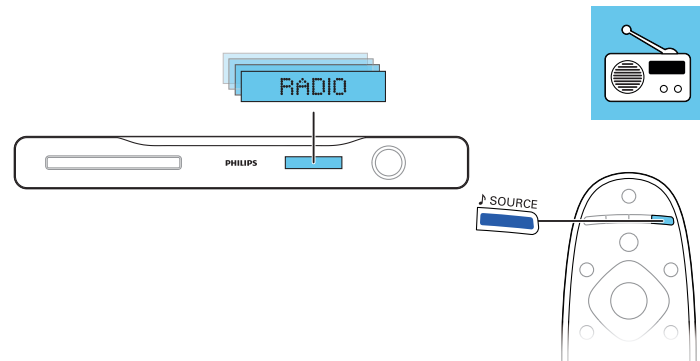
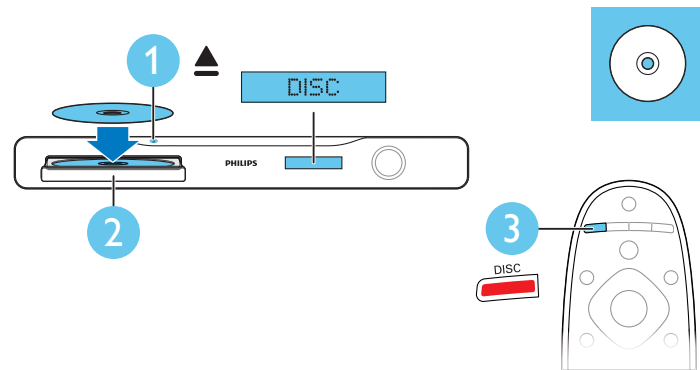

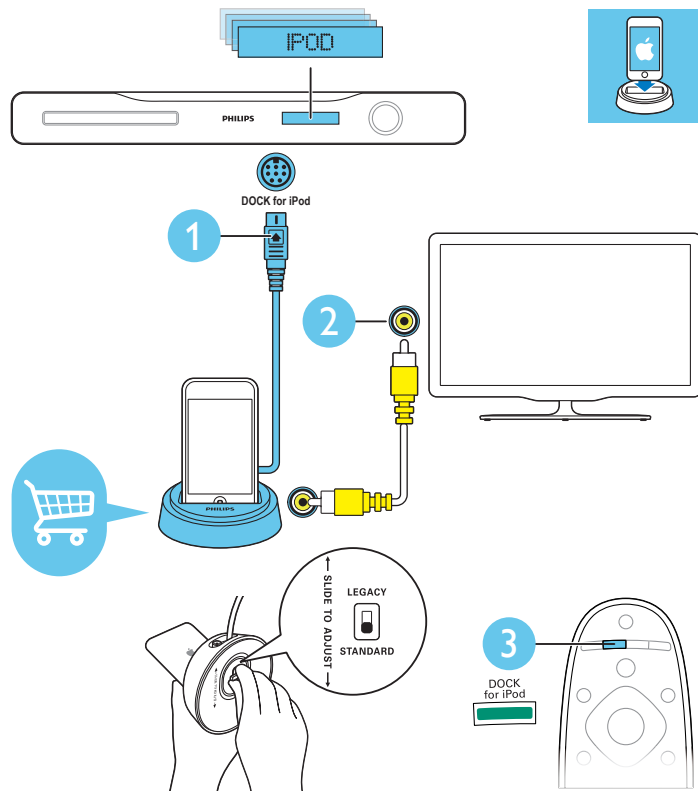
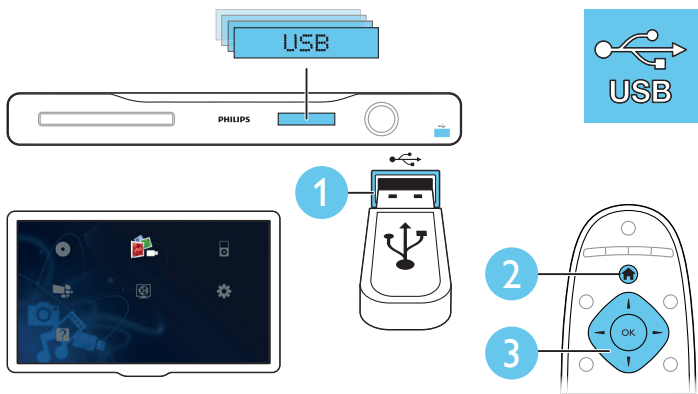
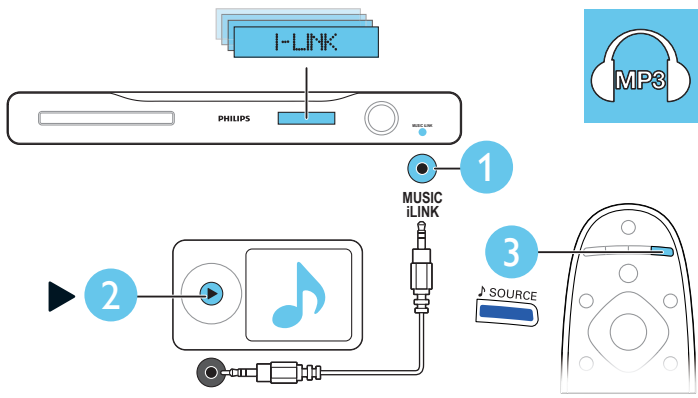



- EN** Need more information about your product? Search the onscreen help.
- ES** ¿Necesita más información acerca de este producto? Revise la ayuda en pantalla.
- PT** Precisa de mais informações sobre o seu produto? Faça uma busca na tela de ajuda.

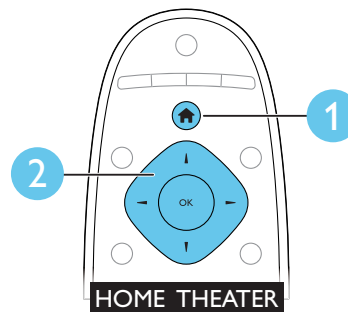



- EN** For sustainability, the user manual is not printed and available in your product as onscreen help. A printable user manual as well as product updates is available from www.philips.com/support.
- ES** Por motivos de sustentabilidad este manual no se ha impreso, y se encuentra disponible en la ayuda en pantalla de su producto. En www.philips.com/support puede encontrar un manual para imprimir; además de las actualizaciones para este producto.
- PT** Para fins de sustentabilidade, o manual do usuário não é impresso e não está disponível no seu produto como ajuda na tela. O manual do usuário como também as atualizações do produto estão disponíveis no www.philips.com/support.





Non-contractual images. / Images non contractuelles. / Außervertragliche Bilder.

All registered and unregistered trademarks are property of their respective owners.

Specifications are subject to change without notice

Trademarks are the property of Koninklijke Philips Electronics N.V. or their respective owners

2011 © Koninklijke Philips Electronics N.V. All rights reserved

www.philips.com

ythy_1113/78_v1

Evite o uso prolongado do aparelho com volume superior a 85 decibéis, pois isto poderá prejudicar a sua audição.

Potência total de saída de 800W RMS, 10% THD



Be responsible
Respect copyrights

