

Register your product and get support at
www.philips.com/welcome

HTS9520



Quick Start

PHILIPS



- EN** This document contains two Quick start guides. To set up your home theater, click on the image that corresponds to the remote control available in your box.
- DE** Dieses Dokument enthält zwei Kurzanleitungen. Um Ihr Heimkino einzurichten, klicken Sie auf das Bild, das der in Ihrem Paket enthaltenen Fernbedienung entspricht.
- FR** Ce document contient deux guides de démarrage rapide. Pour configurer votre système Home Cinéma, cliquez sur l'image correspondant à la télécommande fournie dans la boîte.
- NL** Dit document bevat twee Snelstartgidsen. Om uw home cinema in te stellen, klikt u op de afbeelding die overeenkomt met de afstandsbediening in de doos.
- IT** Questo documento contiene due Guide di avvio rapido. Per impostare il sistema Home Theater, fare clic sull'immagine corrispondente al telecomando disponibile nella scatola.
- ES** Este documento incluye dos guías de inicio rápido. Para configurar su sistema de cine en casa, haga clic en la imagen que corresponde al mando a distancia disponible en la caja.
- PT** Este documento contém dois Guias de início rápido. Para configurar o sistema de cinema em casa, clique na imagem correspondente ao telecomando disponível na sua caixa.
- DA** Dette dokument indeholder to lynvejledninger. For at sætte din hjemmebiograf op, skal du klikke på det billede, som svarer til den fjernbetjening, som er tilgængelig i din boks.
- SV** Detta dokument innehåller två snabbstartsguider. För att installera din hemmabio, ska du klicka på bilden som överensstämmer med fjärrkontrollen i förpackningen.
- NO** Dette dokumentet inneholder to hurtigstartguider. Når du skal konfigurere hjemmekinosystemet, klikker du bildet som svarer til fjernkontrollen i esken du fikk.
- FI** Tässä asiakirjassa on kaksi pikaopasta. Ota kotiteatteri käyttöön napsauttamalla kuvaa, joka vastaa pakkauksessa olevaa kaukosäädintä.
- EL** Το έγγραφο αυτό περιέχει δύο οδηγούς Γρήγορης εκκίνησης. Για να ρυθμίσετε το σύστημα home theater, κάντε κλικ στην εικόνα που αντιστοιχεί στο διαθέσιμο τηλεχειριστήριο της συσκευασίας σας.
- RU** В этом документе содержатся два руководства по началу работы. Чтобы настроить ваш домашний кинотеатр, щелкните на изображении, соответствующем пульту ДУ, находящемуся в коробке.
- PL** Niniejszy dokument zawiera dwie skrócone Instrukcje obsługi. Aby skonfigurować swoje kino domowe należy kliknąć na obraz, który odpowiada pilotowi zdalnego sterowania z Twojego opakowania.
- HU** Ez a dokumentum két üzembe helyezési útmutatót tartalmaz. A házimozirendszer beállításához kattintson a csomagban található távirányítónak megfelelő képre.
- SK** Tento dokument obsahuje dve stručné príručky. Ak chcete nastaviť svoje domáce kino, kliknite na obrázok, ktorý zodpovedá diaľkovému ovládaču nachádzajúcemu sa v balení.
- CS** Tento dokument obsahuje dvě příručky Rychlý start. Chcete-li nastavit domácí kino, klikněte na obrázek dálkového ovládní dodaného v balení produktu.
- TR** Bu belge iki Hızlı başlangıç kılavuzu içerir. Ev sinema sisteminizi kurmak için kutunuzdan çıkan uzaktan kumandaya uygun resmi tıklayın.
- RO** Acest document conține două ghiduri de Pornire rapidă. Pentru a vă configura aparatul dumneavoastră home theater, faceți clic pe imaginea care corespunde telecomenzii disponibile în cutia dumneavoastră.
- UK** Цей документ містить два Коротких посібники. Щоб налаштувати систему домашнього кінотеатру, клацніть на зображенні, яке відповідає пульта дистанційного керування в комплекті.
- PT BR** Este documento contém dois guias de Instruções básicas de uso. Para configurar seu home theater, clique na figura correspondente ao controle remoto disponível na caixa do produto.
- ES MX** Este documento contiene dos Guías de inicio rápido. Para configurar su sistema de cine en casa, haga clic en la imagen que corresponde al control remoto disponible en el televisor.
- MS** Dokumen ini mengandungi dua Panduan bermula ringkas. Untuk membuat persediaan teater rumah anda, klik pada imej yang sepadan dengan alat kawalan jauh yang tersedia dalam kotak anda.
- HI** इस दस्तावेज़ में दो क्विक स्टार्ट गाइड शामिल हैं। अपना होम थिएटर सेट करने के लिए, अपने बॉक्स में दिए गए रिमोट कंट्रोल से दिए गए चित्र पर क्लिक करें।
- ZH CN** 本文档包含两个快速入门指南。要设置您的家庭影院，请单击与包装盒中的遥控器相对应的图片。
- ZH HK** 本文件包含两份快速入门指南。如果要安装家庭影院，按一下對應到盒子中遥控器的影像。

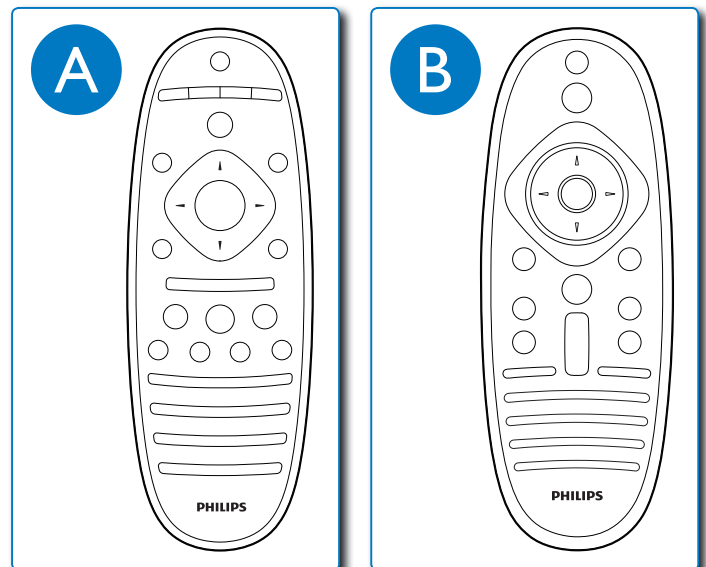

A

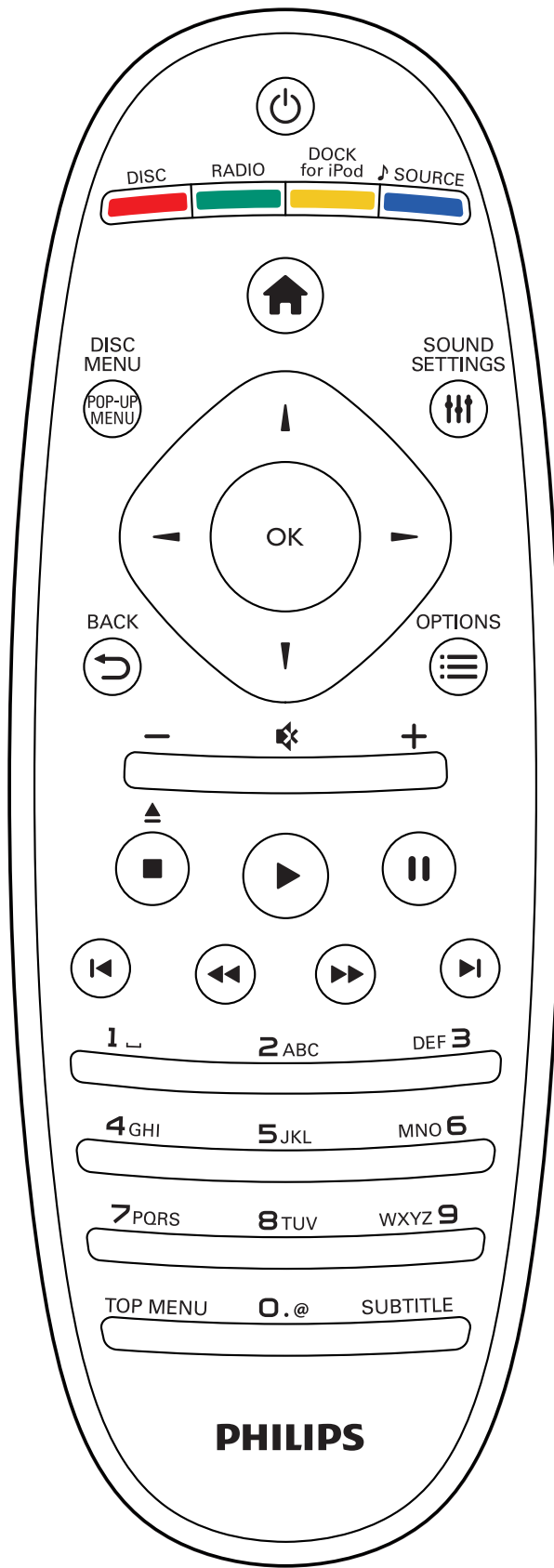

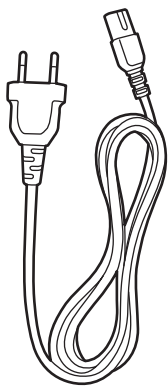
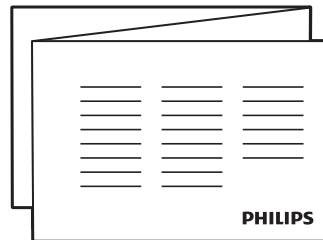
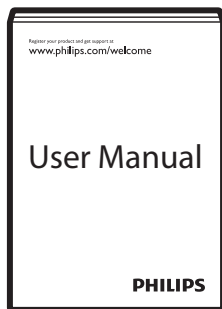
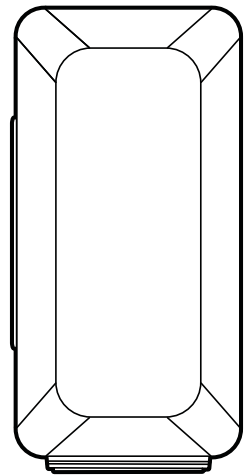
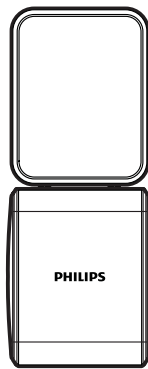
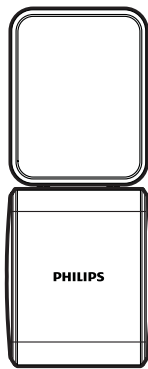
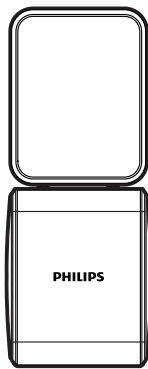
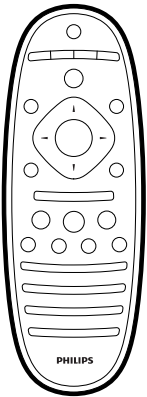
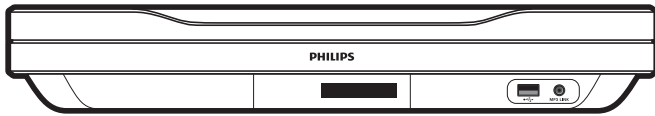

Power Cord



FM Antenna

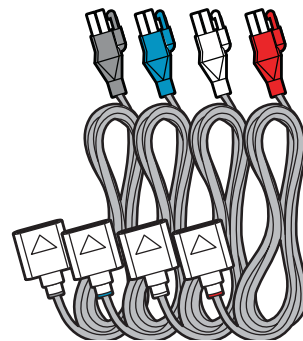

Speaker Cables

1

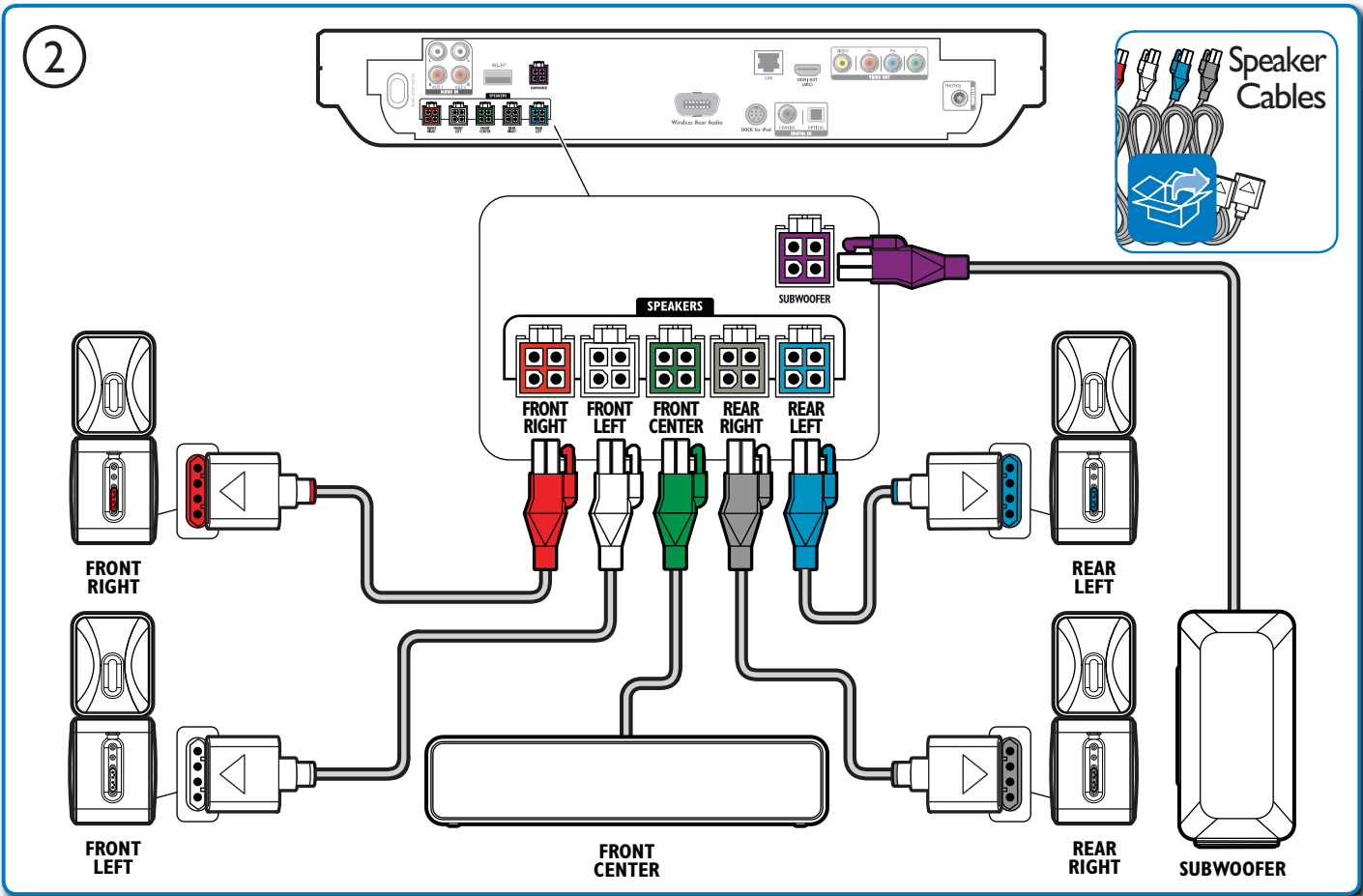
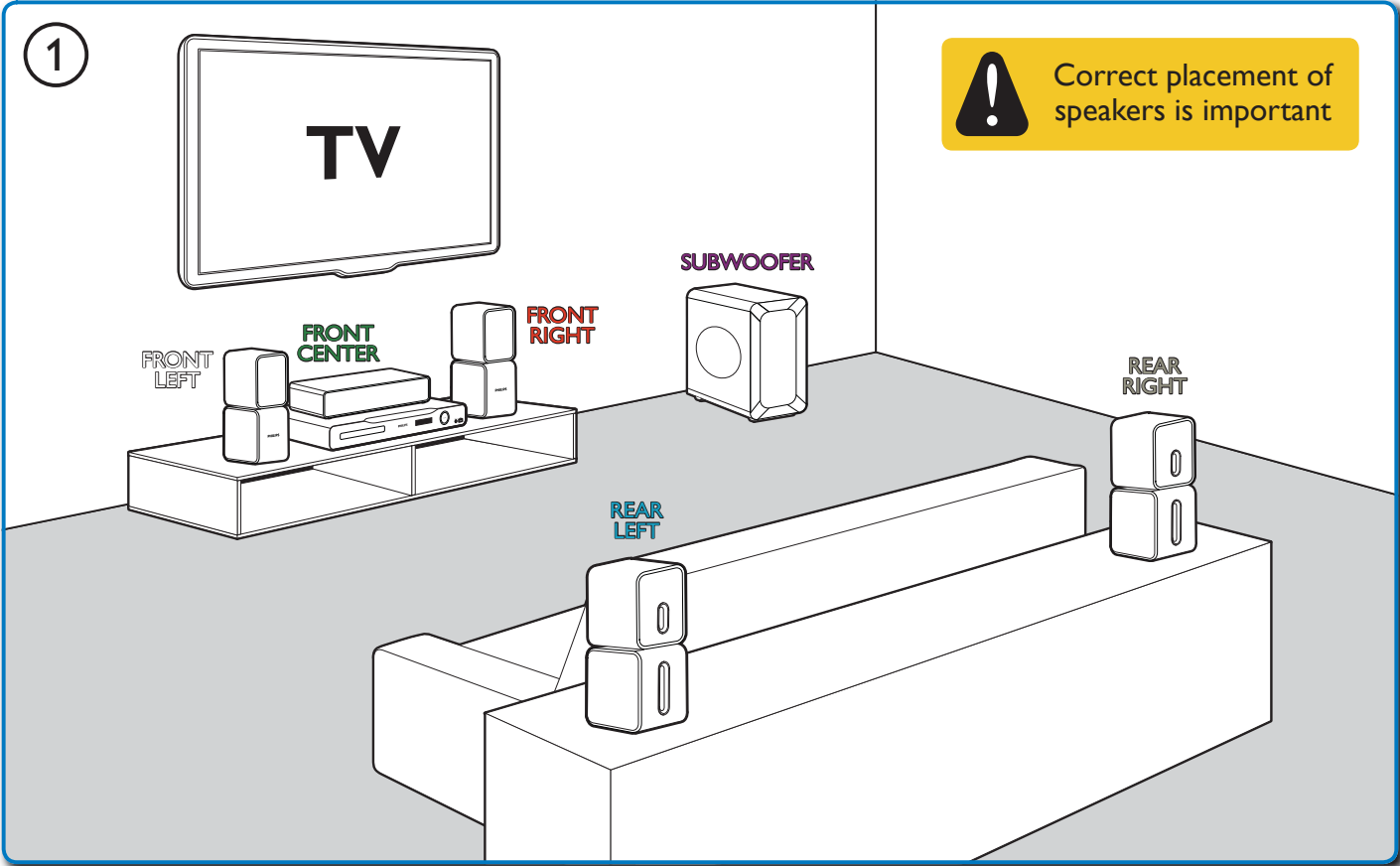

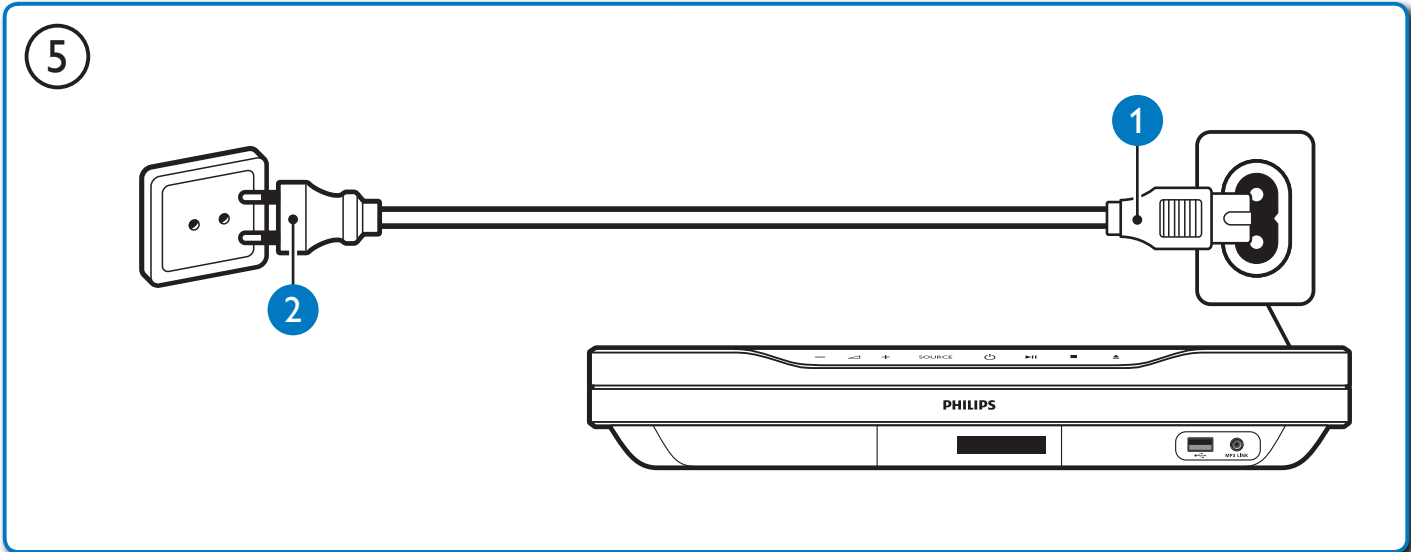
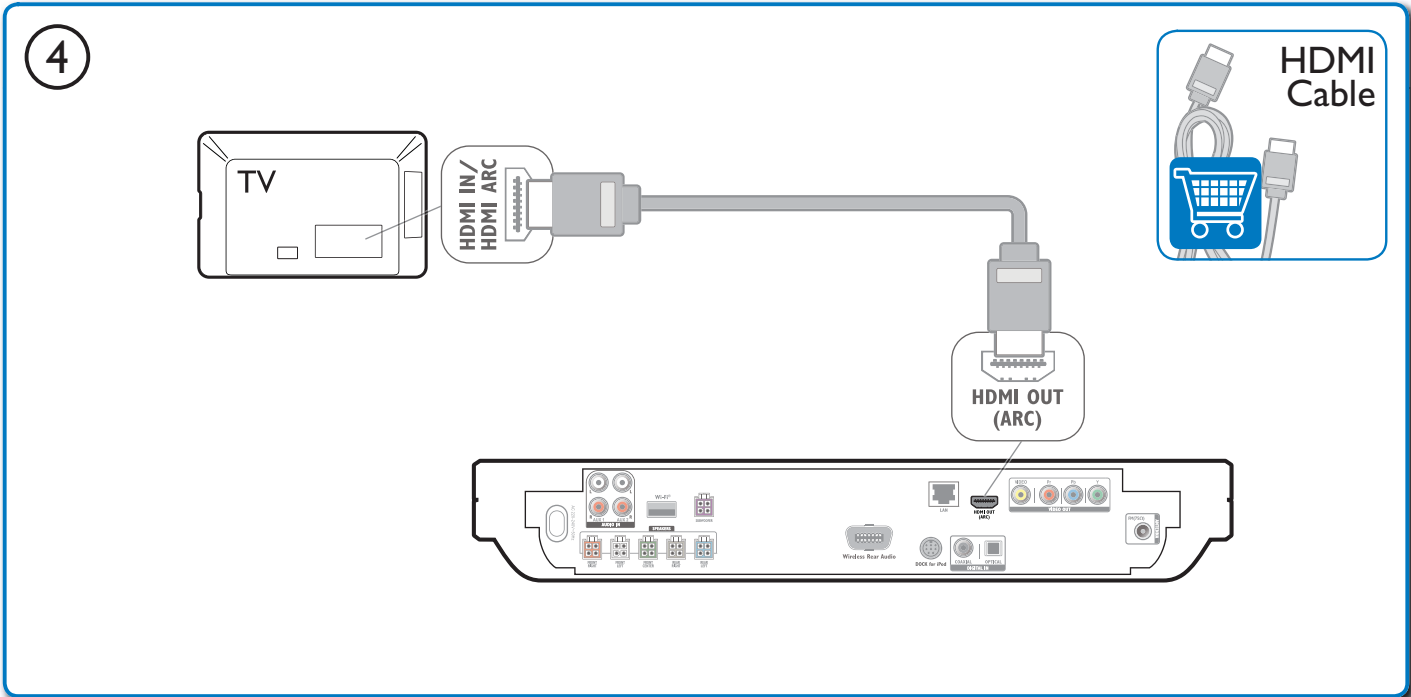
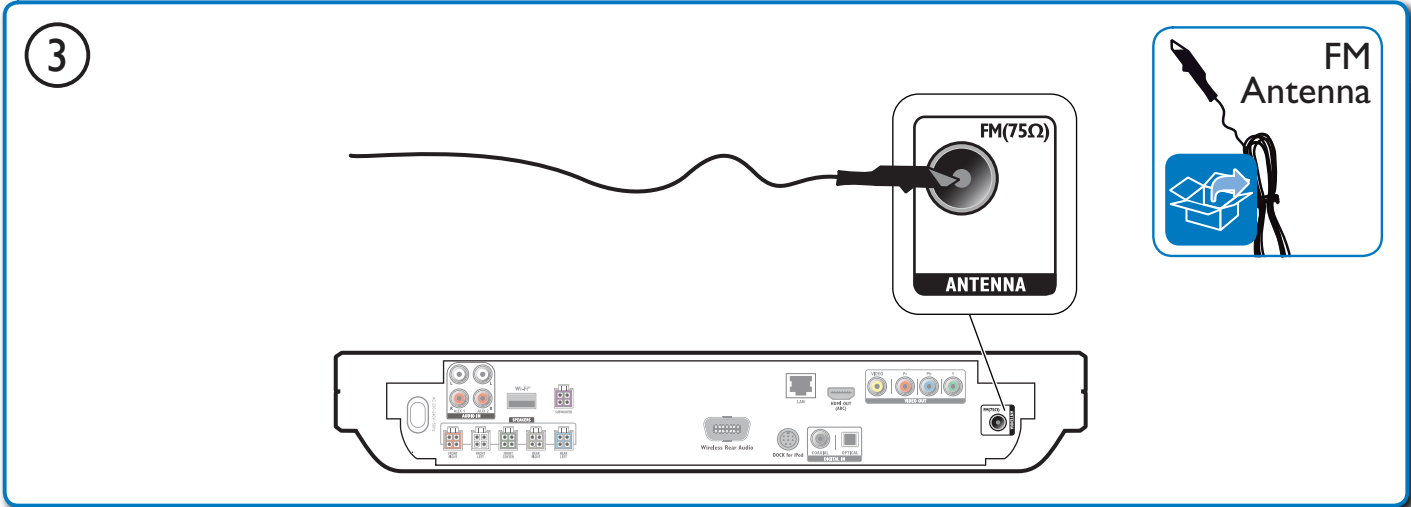

6

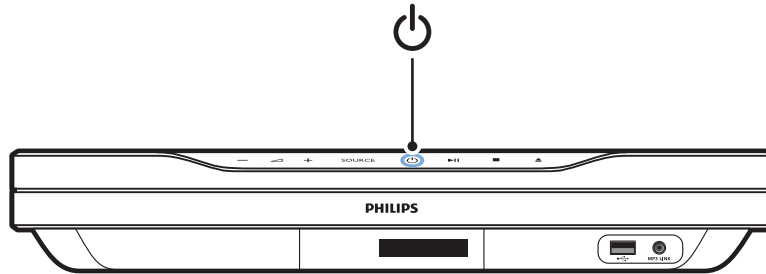

7

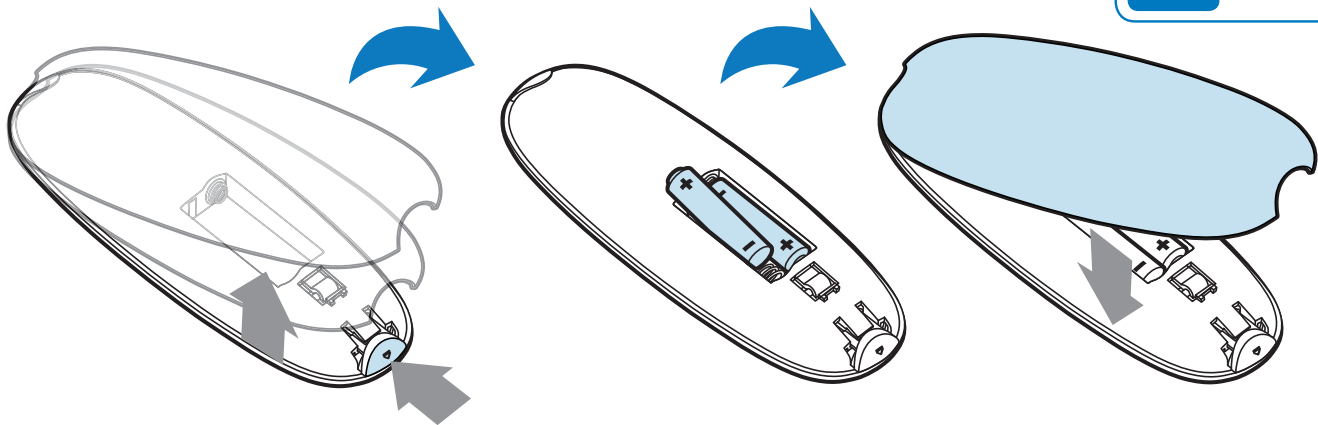
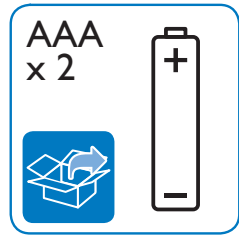

2

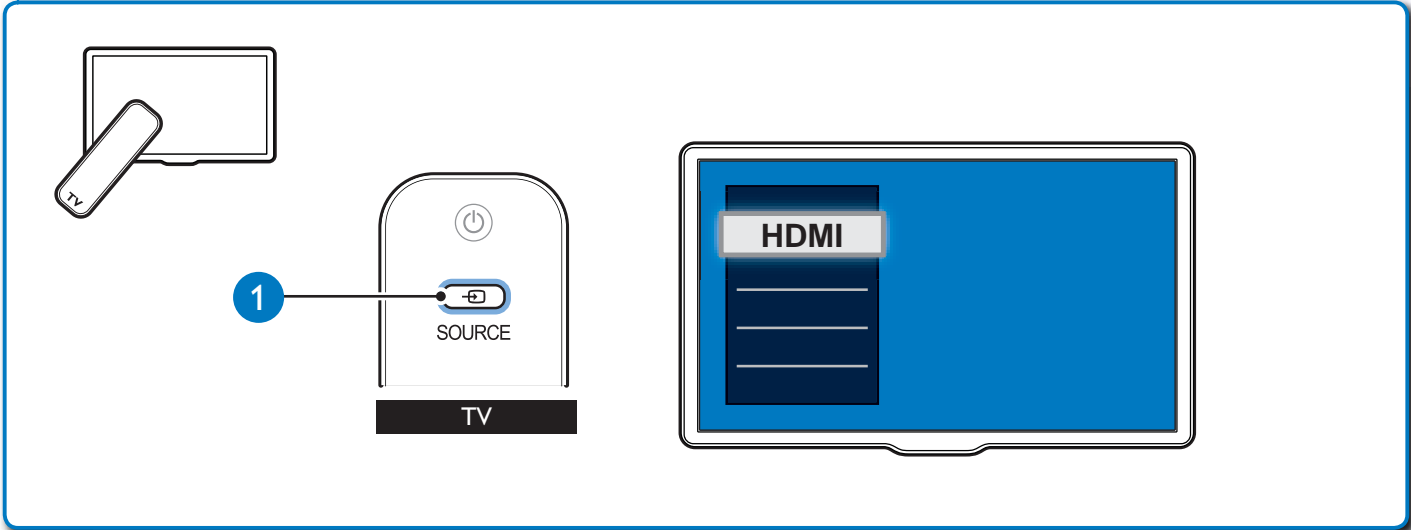

3

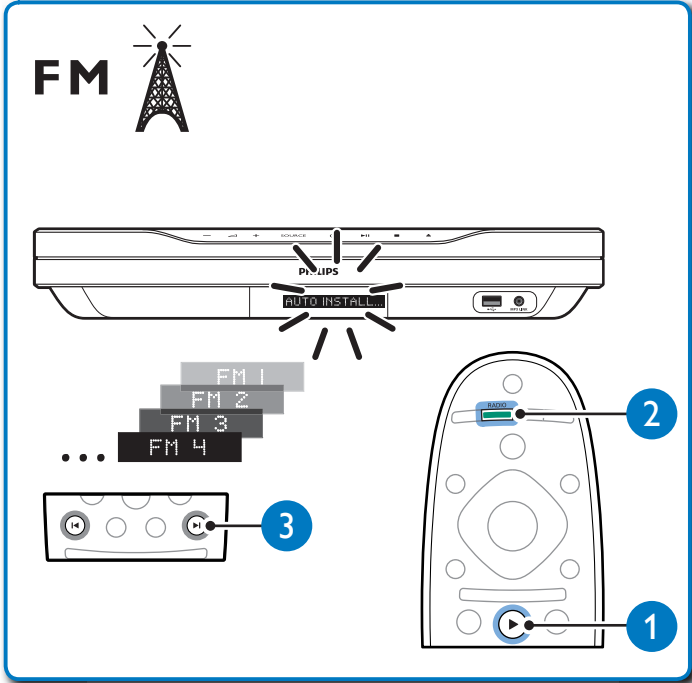
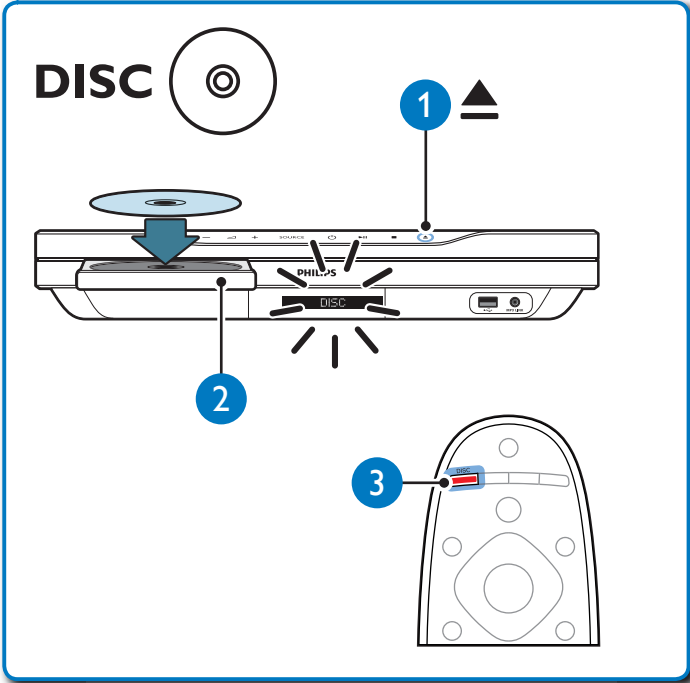

▶

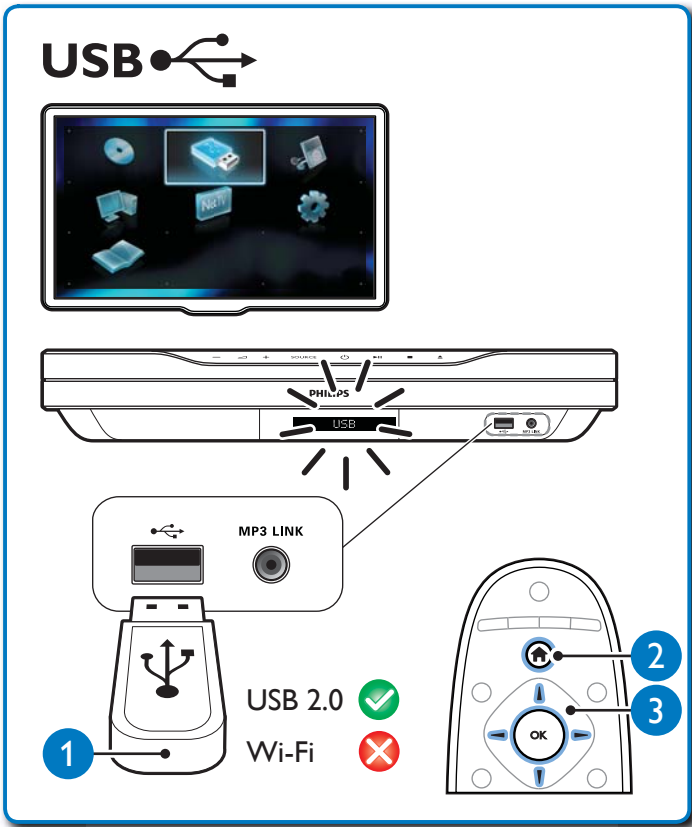
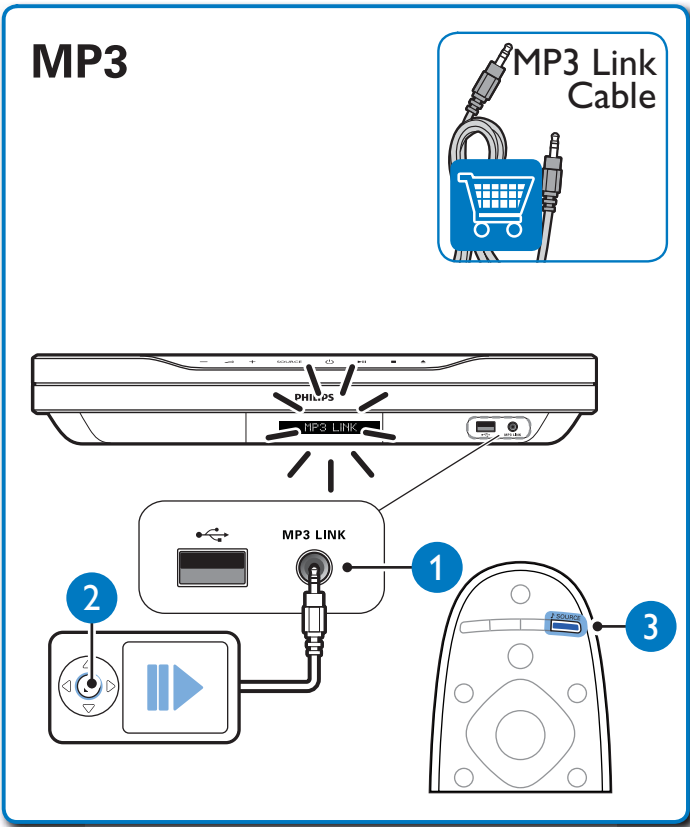

Browse PC / NetTV



Philips WUB110

USB 2.0 ❌

Wi-Fi ✅

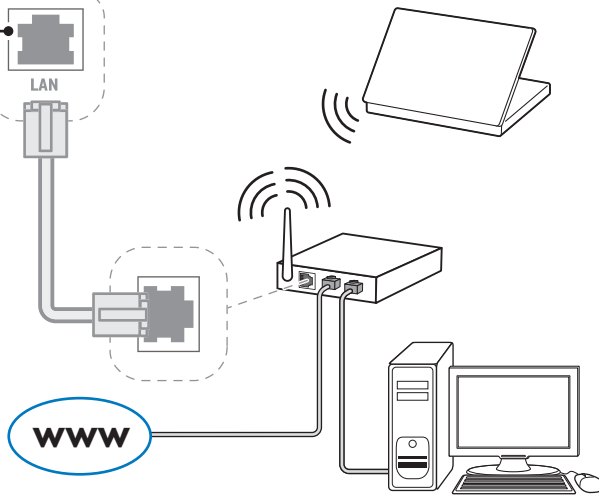

Wireless
USB
adapter



Philips
WUB110

OR

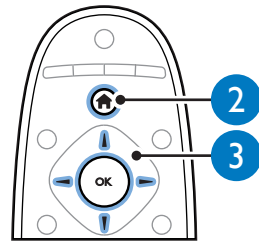
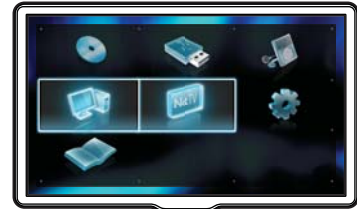

iPod / iPhone

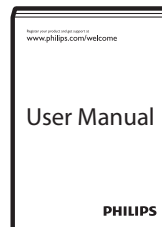
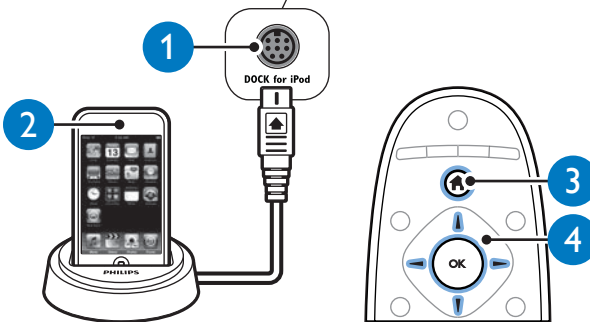

www.philips.com/support



Specifications are subject to change without notice
Trademarks are the property of Koninklijke Philips Electronics N.V.
or their respective owners
2010 © Koninklijke Philips Electronics N.V. All rights reserved.
sgthy_1050/93_v2



Be responsible
Respect copyrights



B

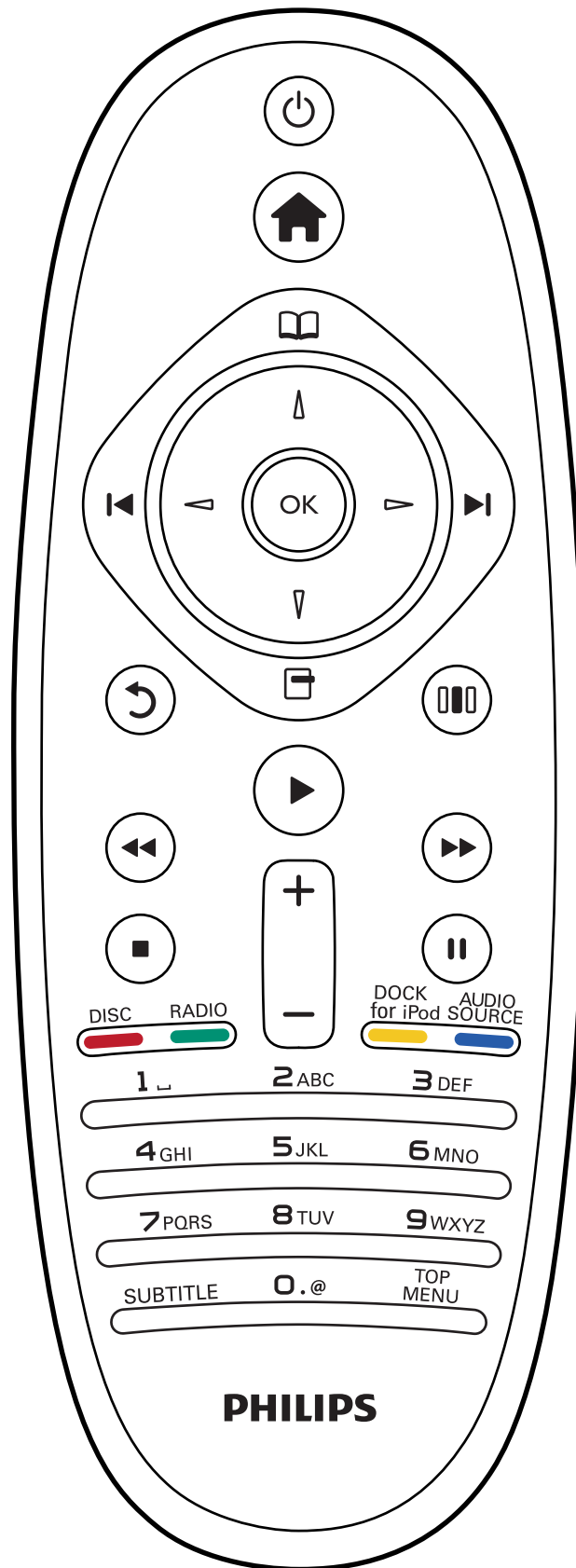

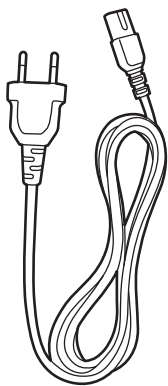
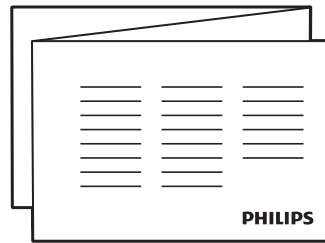
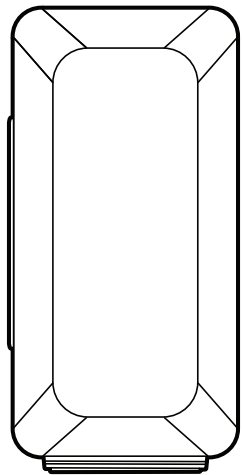
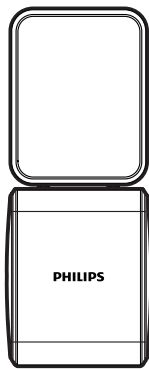
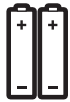
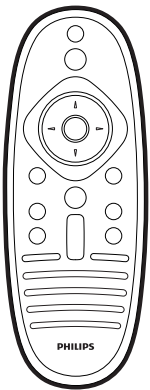
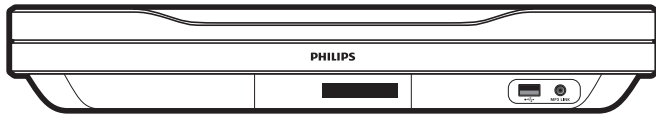

Power Cord



FM Antenna

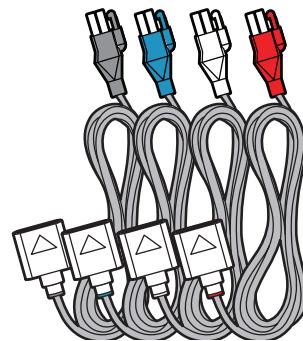

Speaker Cables

1

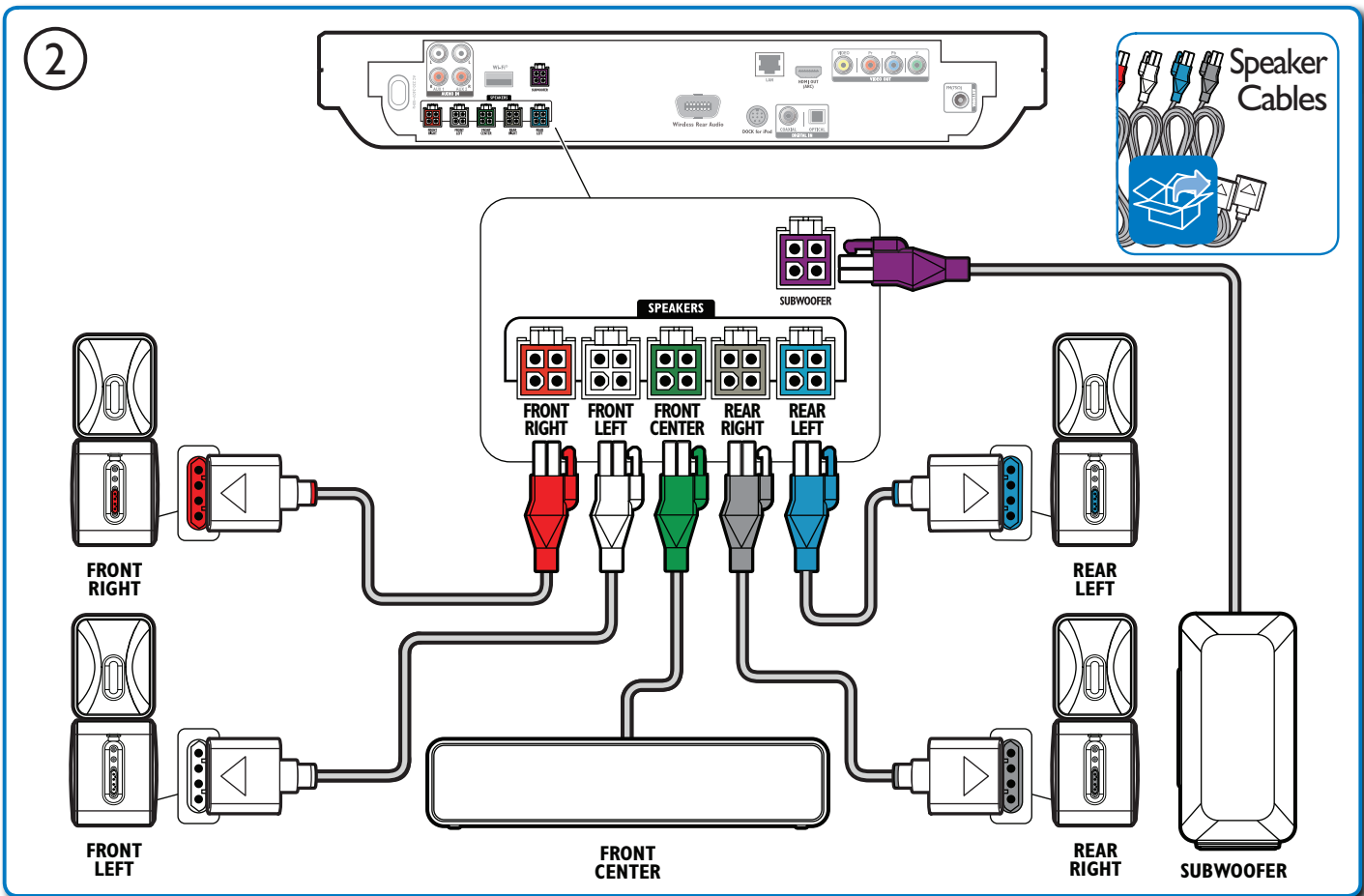
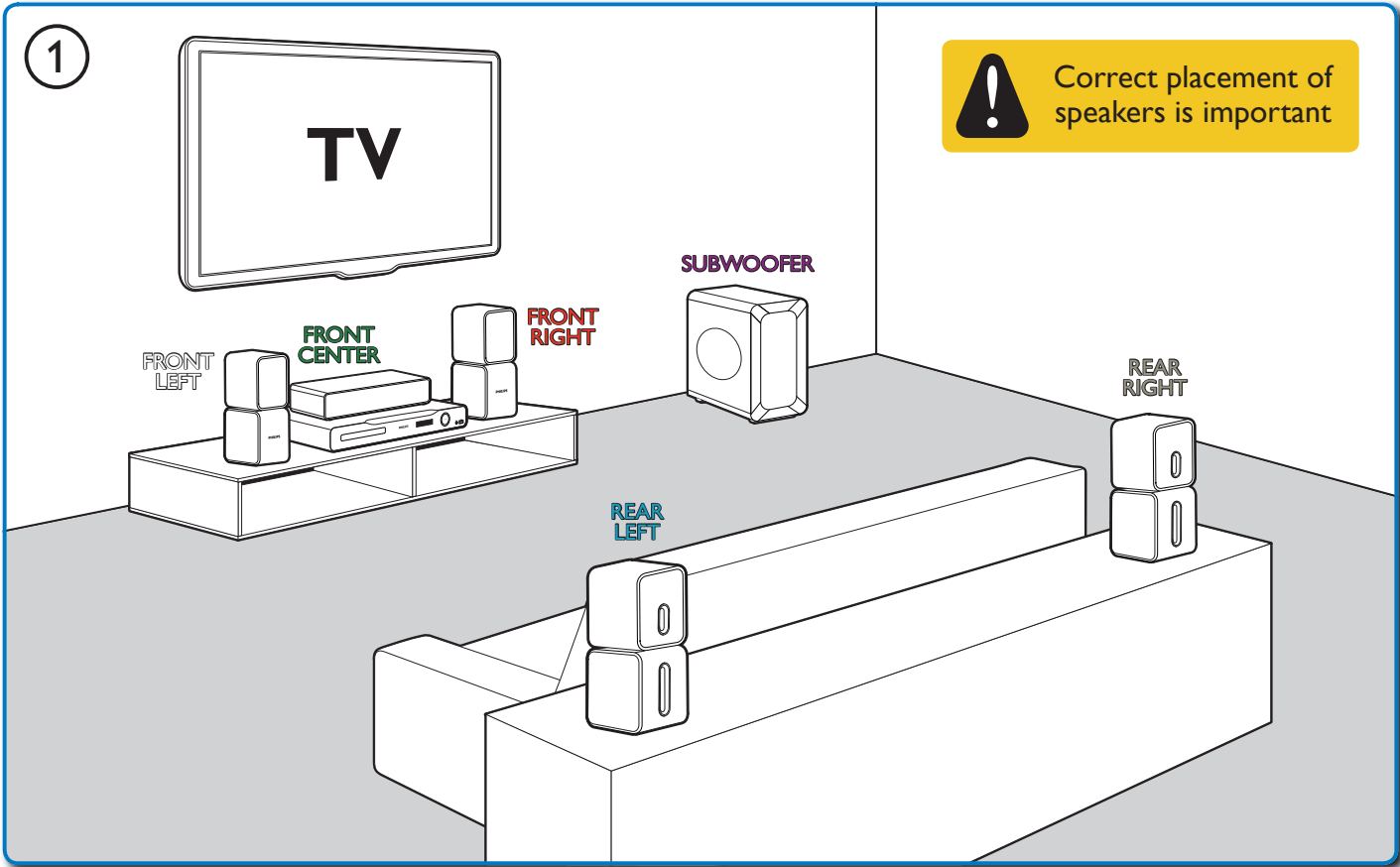

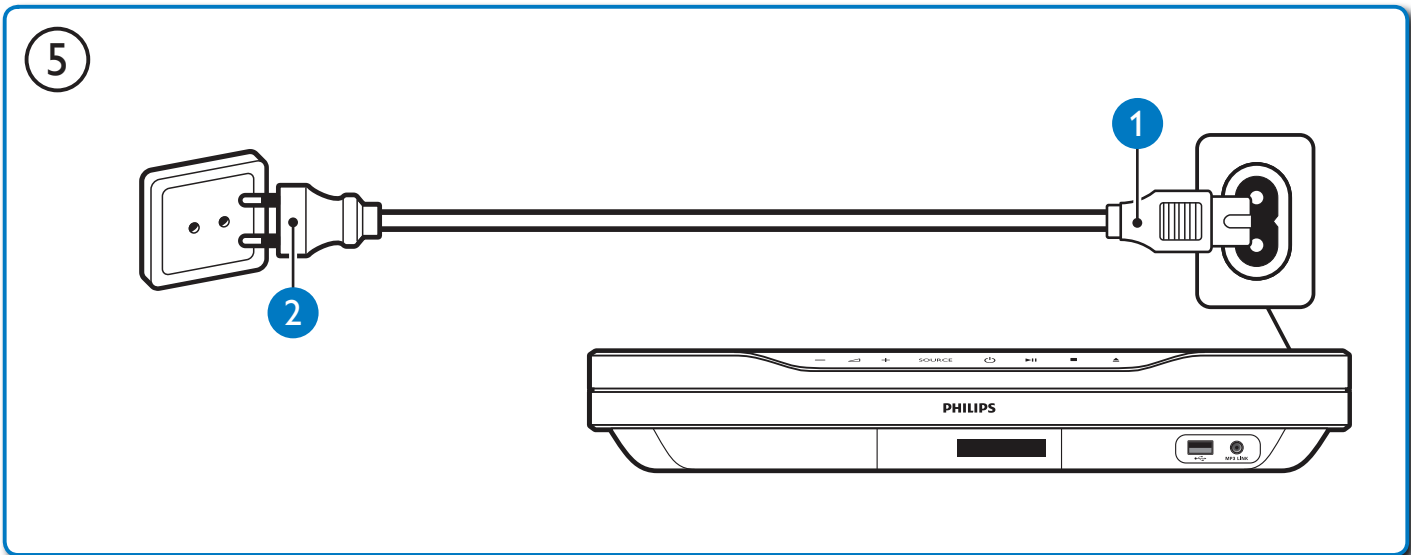
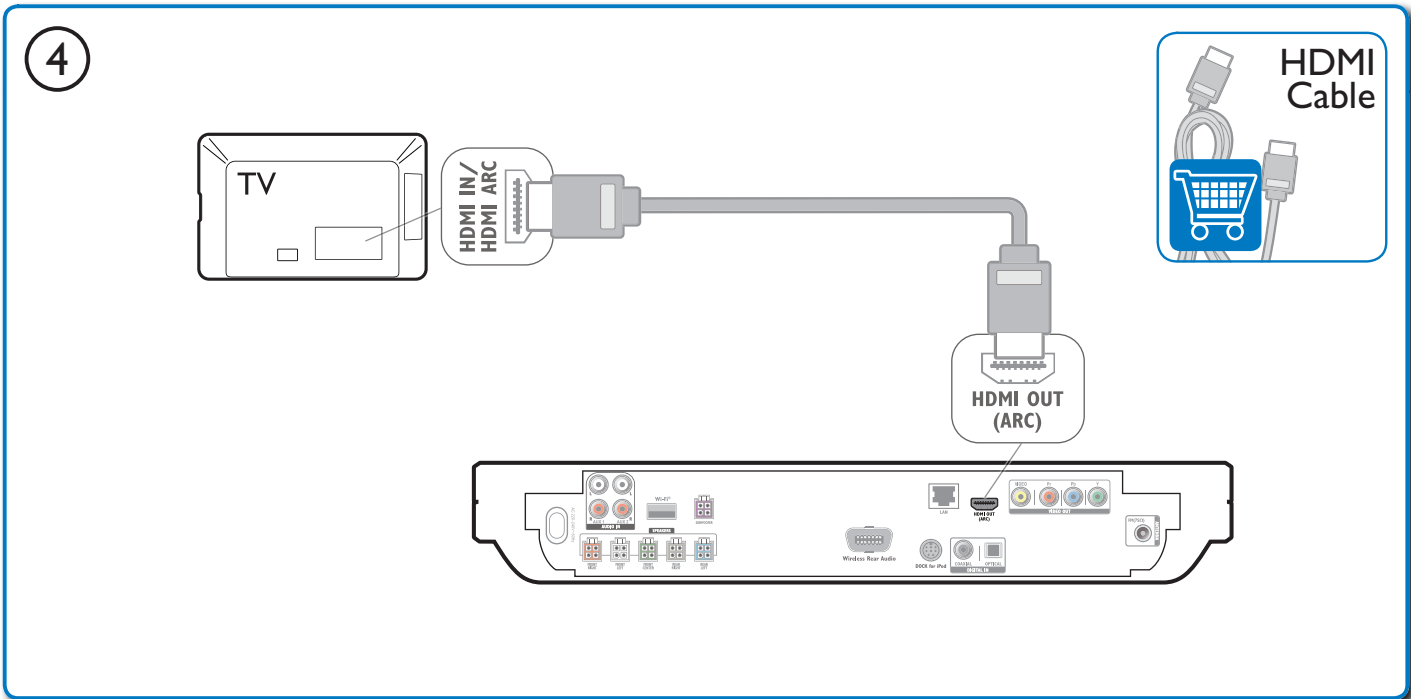
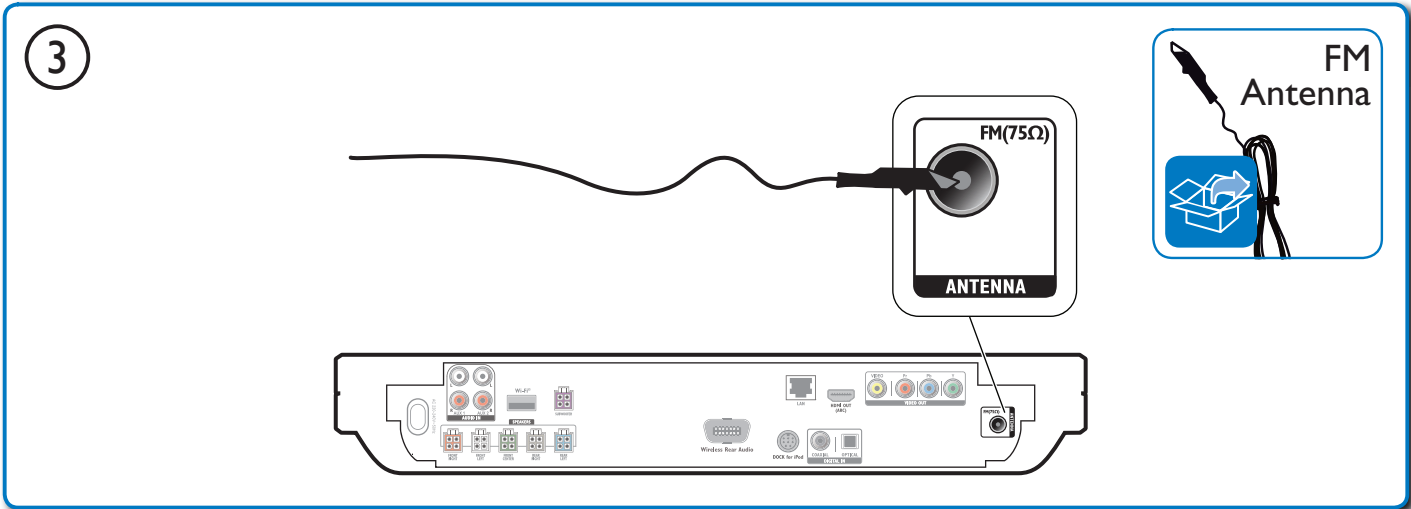

6

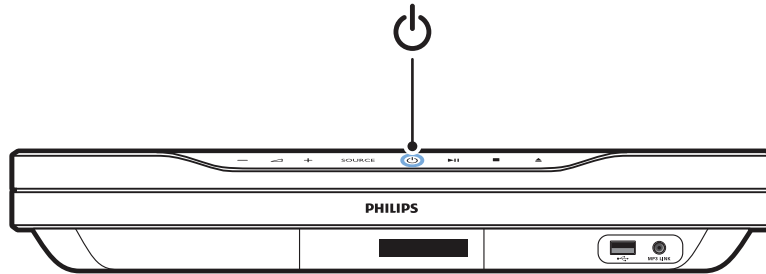

7

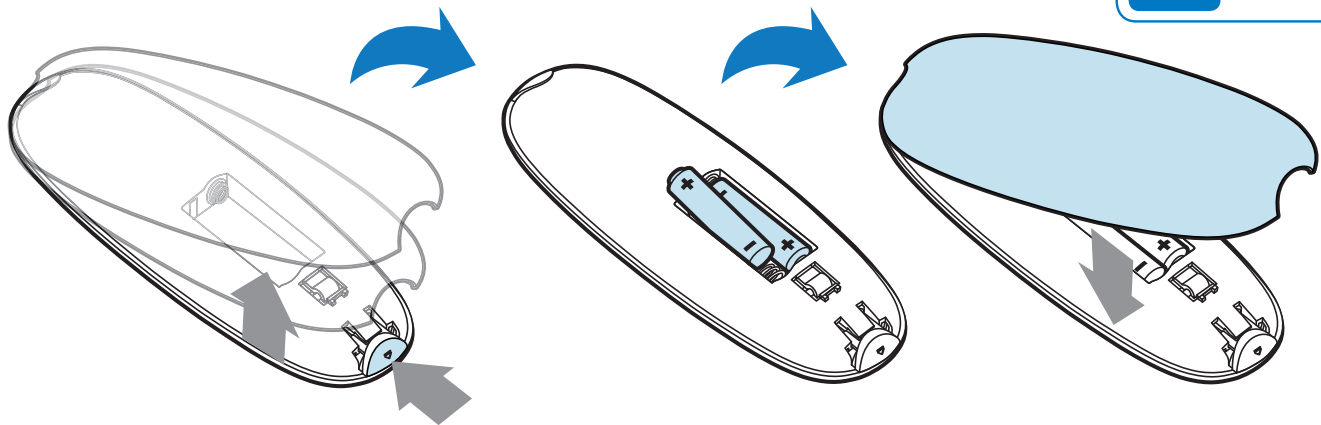

2

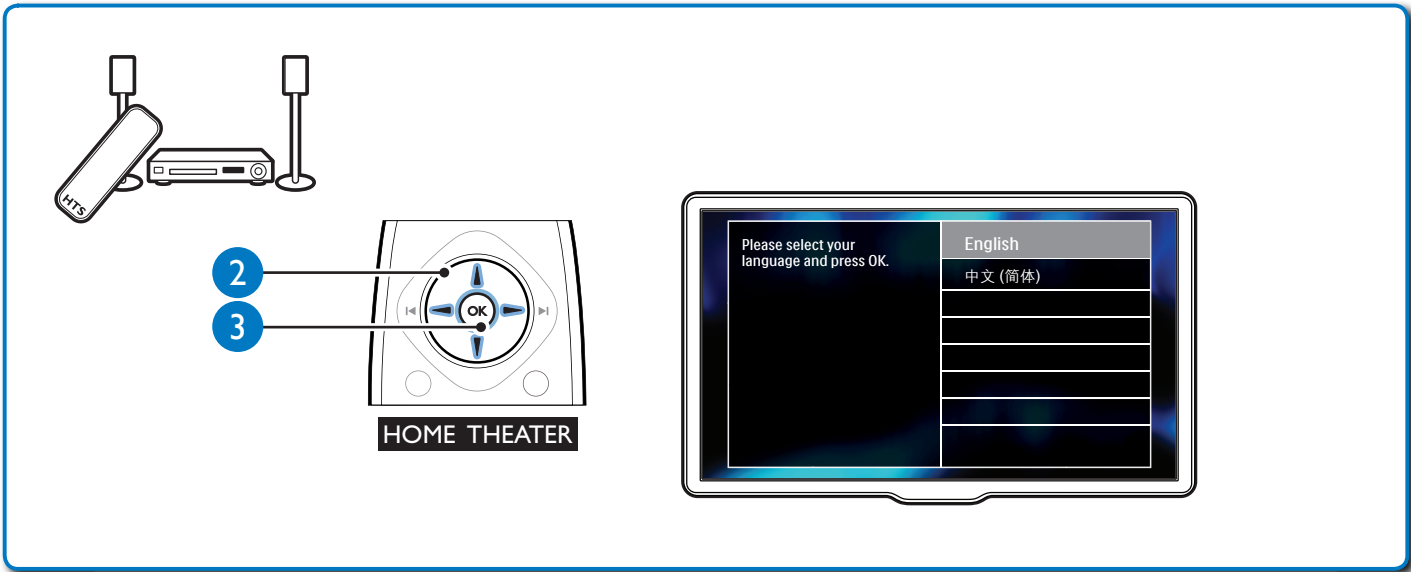
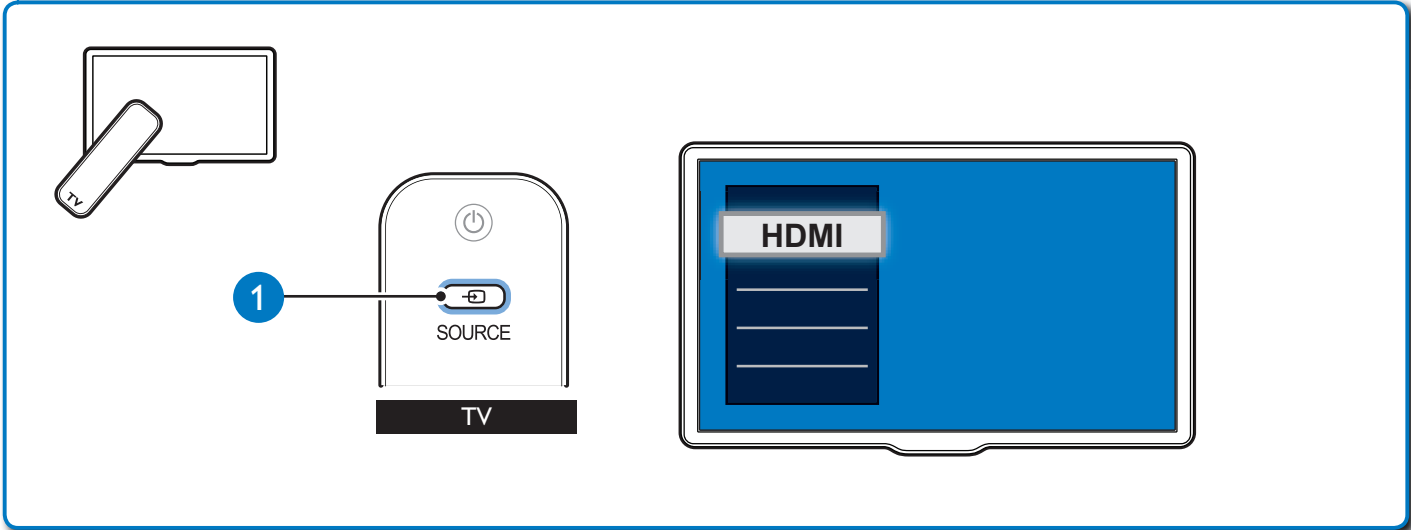

3

DISC

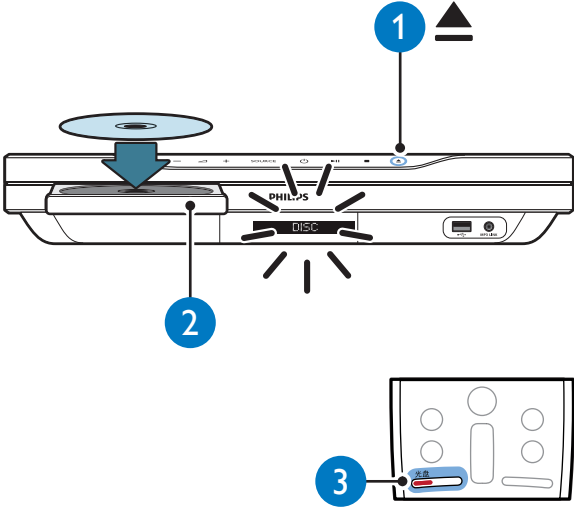

- 1
- 2
- 3

FM

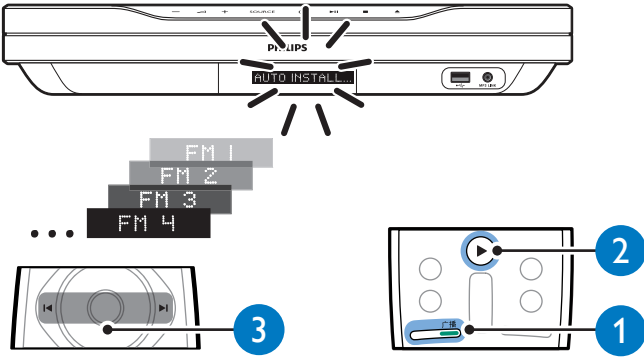

- 1
- 2
- 3

▶

MP3

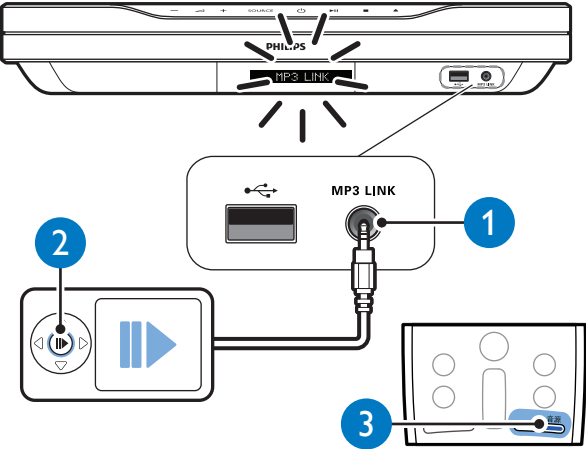

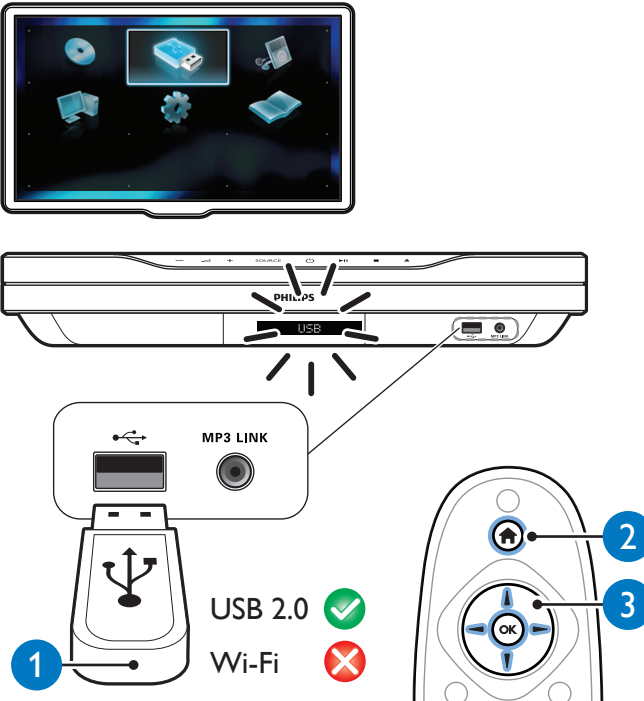

- 1
- 2
- 3

USB



- 1
- 2
- 3

USB 2.0 

Wi-Fi 

Browse PC

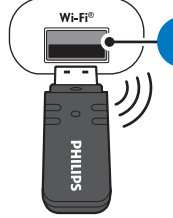
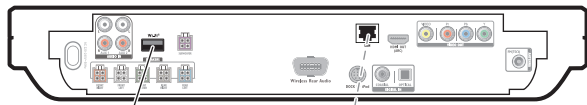

Philips WUB1110

- USB 2.0
- Wi-Fi

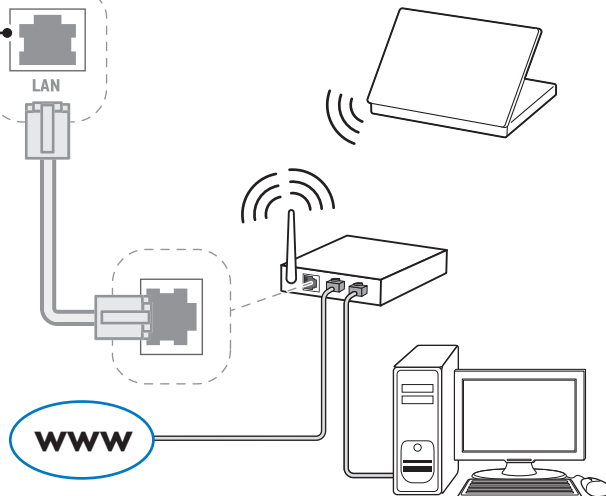

Wireless USB adapter
Philips WUB1110

OR

Network Cable

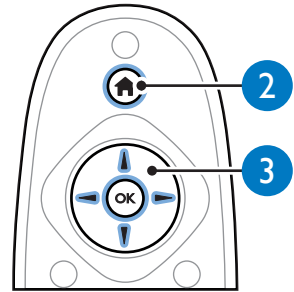

iPod / iPhone

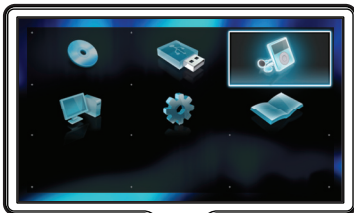

DOCK for iPod
Philips DCK3060

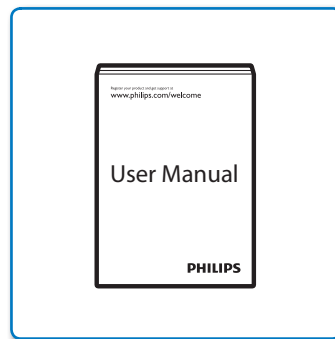
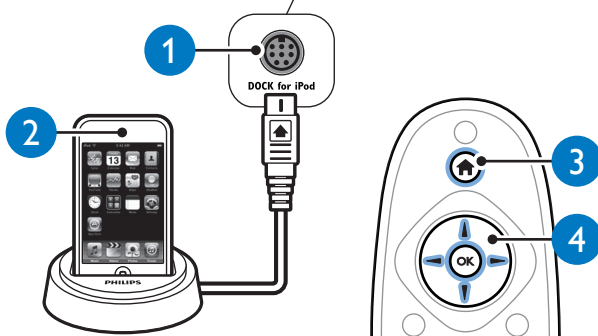

Specifications are subject to change without notice
Trademarks are the property of Koninklijke Philips Electronics N.V. or their respective owners
2010 © Koninklijke Philips Electronics N.V. All rights reserved.
sgyth_1020/93_v1

Be responsible
Respect copyrights

