

PHILIPS

Party Speaker

4000 Series

TAX4207



User manual

Register your product and get support at
www.philips.com/support

Contents

1	Important safety instructions	3
	Safety	3
	Care for your product	4
	Care of the environment	4
	Compliance	4
	Help and support	4
	Hearing safety	5
	Built-in battery care	5
	Trademarks	5
<hr/>		
2	Your party speaker	7
	What's in the box	7
	Party speaker	8
<hr/>		
3	Get started	9
	Connect to power	9
	Turn On and Off	10
	Volume control	10
	DBB control	10
	Charge the built-in battery	10
	Change light effect	11
	Play from Bluetooth devices	12
	Pairing for stereo mode (TWS)	13
	Party link mode	14
	Play audio through USB	15
	Listen to an external device	16
	Sing through microphone	16
	Factory reset	16
	Update firmware via USB	17
	Pole-Mounting your Party speaker	17
<hr/>		
4	Product specifications	18
<hr/>		
5	Troubleshooting	19

1 Important safety instructions

Read and understand all instructions before you use your product. If damage is caused by failure to follow instructions, the warranty does not apply.

Safety

Know these safety symbols

	CAUTION RISK OF ELECTRIC SHOCK DO NOT OPEN	
CAUTION: TO REDUCE THE RISK OF ELECTRIC SHOCK, DO NOT REMOVE COVER (OR BACK). NO USER-SERVICEABLE PARTS INSIDE. REFER SERVICING TO QUALIFIED SERVICE PERSONNEL.		



This is **CLASS II** apparatus with double insulation, and no protective earth provided.



AC voltage



Use only the power supplies listed in the user manual.



WARNING!
Warning: risk of electric shock!



The exclamation mark is intended to alert the user to the presence of important operating instructions.

Risk of electric shock or fire!

- Before you make or change any connections, make sure that all devices are disconnected from the power outlet.
- Never expose the product and accessories to rain or water. Never place liquid containers, such as vases, near the product. If liquids are spilled on or into the product, disconnect it

from the power outlet immediately. Contact Consumer Care to have the product checked before use.

- Never place the product and accessories near naked flames or other heat sources, including direct sunlight.
- Never insert objects into the ventilation slots or other openings on the product.
- Where the mains plug or an appliance coupler is used as the disconnect device, the disconnect device shall remain readily operable.
- Disconnect the product from the power outlet before lightning storms.
- When you disconnect the power cord, always pull the plug, never the cable.
- Use the product in tropical and/or moderate climates.

Risk of short circuit or fire!

- For identification and supply ratings, see the type plate at the back or bottom of the product.
- Before you connect the product to the power outlet, ensure that the power voltage matches the value printed on the back or bottom of the product. Never connect the product to the power outlet if the voltage is different.

Risk of injury or damage to this product!

- For wall mounting, this product must be securely attached to the wall in accordance with the installation instructions. Use only the supplied wall mount bracket (if available). Improper wall mounting may result in accident, injury or damage. If you have any query, contact Consumer Care in your country.
- Never place the product or any objects on power cords or on other electrical equipment.

- If the product is transported in temperatures below 5°C, unpack the product and wait until its temperature matches room temperature before connecting it to the power outlet.
- Parts of this product can be made of glass. Handle with care to avoid injury and damage.

Risk of overheating!

- Never install this product in a confined space. Always leave a space of at least four inches around the product for ventilation. Ensure curtains or other objects never cover the ventilation slots on the product.

Note

- The rating label is pasted on the bottom or back of the equipment.

Care for your product

Use only microfiber cloth to clean the product.

Care of the environment

Disposal of your old product and battery



Your product is designed and manufactured with high quality materials and components, which can be recycled and reused.



This symbol on a product means that the product is covered by European Directive 2012/19/EU.



This symbol means that the product contains batteries covered by European Directive 2013/56/EU which cannot be disposed of with normal household waste. Inform

yourself about the local separate collection system for electrical and electronic products and batteries. Follow local rules and never dispose of the product and batteries with normal household waste. Correct disposal of old products and batteries helps prevent negative consequences for the environment and human health.

Declaration of conformity

This product complies with the radio interference requirements of the European community.

Hereby, MMD Hong Kong Holding Limited declares that the product is in compliance with the essential requirements and other relevant provisions of RED Directive 2014/53/EU and UK Radio Equipment Regulations SI 2017 No 1206. You can find the Declaration of Conformity on www.philips.com/support.

Help and support

For extensive online support, visit www.philips.com/support to:

- download the user manual and the quick start guide
- watch video tutorials (available only for selected models)
- find answers to frequently answered questions (FAQs)
- email us a question
- chat with our support representative.

Follow the instructions on the website to select your language, and then enter your product model number.

Alternatively, you can contact Consumer Care in your country. Before you contact, note down the model number and serial number of your product. You can find this information on the back or bottom of your product.

Hearing safety



Listen at a moderate volume

- To establish a safe volume level Listen for reasonable periods of time Using headphones at a high volume can impair your hearing. This product can produce sounds in decibel ranges that may cause hearing loss for a normal person, even for exposure less than a minute. The higher decibel ranges are offered for those that may have already experienced some hearing loss.
- Sound can be deceiving. Over time your hearing 'comfort level' adapts to higher volumes of sound. So after prolonged listening, what sounds 'normal' can actually be loud and harmful to your hearing. To guard against this, set your volume to a safe level before your hearing adapts and leave it there.

To establish a safe volume level

- Set your volume control at a low setting.
- Slowly increase the sound until you can hear it comfortably and clearly without distortion.

Listen for reasonable periods of time

- Prolonged exposure to sound, even at normally safe levels, can also cause hearing loss.
- Be sure to use your equipment reasonably and take appropriate breaks.
- **Be sure to observe the following guidelines when using your headphones**

- Listen at reasonable volumes for reasonable periods of time.
- Be careful not to adjust the volume as your hearing adapts.
- Do not turn up the volume so high that you can't hear what's around you.
- You should use caution or temporarily discontinue use in potentially hazardous situations.

Built-in battery care

- The battery can be charged and discharged hundreds of times, but will eventually wear out.
- If left unused, a fully charged battery will lose its charge over time.
- Leaving the product in hot or cold places, such as in a closed car in the summer and winter conditions, will reduce the capacity and lifetime of the battery.
- Always try to keep your device in a cool, moisture-free environment that's less than 32°C. A product with a hot or cold battery may not work temporarily, even when the battery is fully charged. Battery performance is particularly limited in temperatures well below freezing.

Trademarks



The Bluetooth® word mark and logos are registered trademarks owned by Bluetooth SIG, Inc. and any use of such marks by MMD Hong Kong Holding Limited is under license. Other trademarks and trade names are those of their respective owners.

FCC information

NOTE: This equipment has been tested and found to comply with the limits for a Class B digital device, pursuant to Part 15 of the FCC Rules. These limits are designed to provide reasonable protection against harmful interference in a residential installation. This equipment generates, uses and can radiate radio frequency energy and, if not installed and used in accordance with the instructions, may cause harmful interference to radio communications.

However, there is no guarantee that interference will not occur in a particular installation. If this equipment does cause harmful interference to radio or television reception, which can be determined by turning the equipment off and on, the user is encouraged to try to correct the interference by one or more of the following measures:

- Reorient or relocate the receiving antenna.
- Increase the separation between the equipment and receiver.
- Connect the equipment into an outlet on a circuit different from that to which the receiver is connected.
- Consult the dealer or an experienced radio / TV technician for help.

IC-Canada: CAN ICES-003(B)/NMB-003(B)

This device contains licence-exempt transmitter(s) / receiver(s) that comply with Innovation, Science and Economic Development Canada's licence-exempt RSS(s). Operation is subject to the following two conditions:

1. This device may not cause interference.
2. This device must accept any interference, including interference that may cause undesired operation of the device.

Avis d'Industrie Canada: CAN ICES-003(B)/NMB-003(B)

L'émetteur/récepteur exempt de licence contenu dans le présent appareil est conforme aux CNR d'Innovation, Sciences et Développement économique Canada applicables aux appareils radio exempts de licence. L'exploitation est autorisée aux deux conditions suivantes :

1. L'appareil ne doit pas produire de brouillage;
2. L'appareil doit accepter tout brouillage radioélectrique subi, même si le brouillage est susceptible d'en compromettre le fonctionnement.

FCC&IC Warning:

- This equipment should be installed and operated with minimum distance 20cm between the radiator & your body.
- Changes or modifications to this unit not expressly approved by the party responsible for compliance could void the user's authority to operate the equipment.

2 Your party speaker

Congratulations on your purchase, and welcome to Philips! To fully benefit from the support that Philips offers, register your party speaker at www.philips.com/support.



Quick Start Guide x 1

What's in the box

Check and identify the items in the package:



Warranty Card x 1

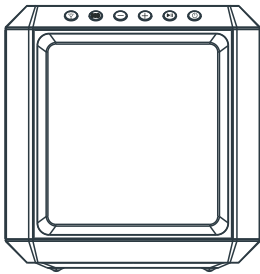

Party Speaker x 1



Safety Sheet x 1



Power Cord * x 1

- Images, illustrations and drawings shown on this user manual are for reference only, actual product may vary in appearance.

- Power cord quantity and plug type vary by regions.

 CCC for China TAX4207/93	 UL for US/Canada TAX4207/37	 VDE BS for Europe/UK TAX4207/10	 VDE BS SAA for Asia TAX4207/98	 BIS for India TAX4207/94	 SNI for Indonesia TAX4207/90	 TISI for Thailand TAX4207/67
------------------------------------	---------------------------------------	---	--	------------------------------------	--	--

Party speaker

This section includes an overview of the party speaker.

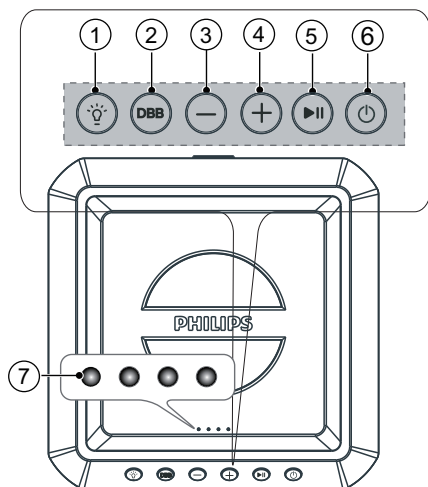

- ① **Light key**
 - Press to change speaker light mode.
 - Press and hold for 3 sec to change speaker light brightness
- ② **DBB key**
 - BASS effect setup.
- ③ **Volume- key**
 - Decrease the volume.
- ④ **Volume+ key**
 - Increase the volume.
- ⑤ **Play/Pause key**
 - Start, pause or resume play.
 - Press and hold for 3 seconds to skip the next track.
- ⑥ **Standby-On key**
 - Press and hold for 3 seconds to switch on/off the unit.
 - Press to check battery level in power on status.
- ⑦ **LED indicator**
 - Battery level indicator
 - Function status

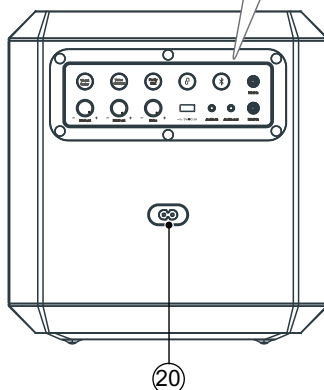
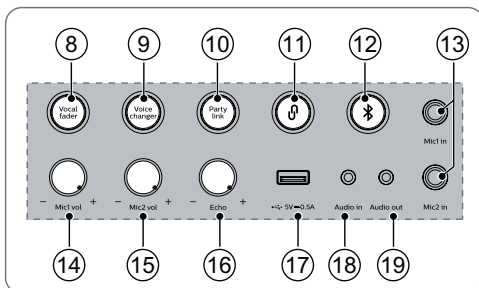

LED	Function	Color
LED1	DBB	Solid yellow
LED2	Standby	Solid red
	Vocal fader	Solid white
LED3	Bluetooth	Blink or solid blue
	TWS pairing	Blink blue-white
	PartyLink connected	Solid white
LED4	Voice changer	Solid green
	PartyLink pairing	Blink green-white

- ⑧ **Vocal fader button**
 - Press repeatedly to switch between vocal fader on and vocal fader off.

- 9 **Voice changer button**
 - Press repeatedly to switch among different voice tones: Woman voice/ Man voice/Children voice/Normal effect.
- 10 **Party link button**
 - Press to enter party link pairing mode.
- 11 **TWS pair button**
 - Press to enter True Wireless Stereo (TWS) pairing mode.
 - It work only when you have two identical speakers.
- 12 **Bluetooth / pair button**
 - Switch to Bluetooth mode.
 - Press and hold to activate the pairing function in Bluetooth mode or disconnect the existing paired Bluetooth device.
- 13 **Mic1 in / Mic2 in socket**
 - Connect a microphone (not supplied) into the Mic1 in / Mic2 in socket on the unit.
- 14 **Mic 1 vol +/- Knob**
 - Adjust microphone volume.
- 15 **Mic 2 vol +/- Knob**
 - Adjust microphone volume.
- 16 **Echo +/- Knob**
 - Adjust the microphone echo level.
- 17 **USB (5V, 0.5A) socket**
 - Insert the USB device to play music.
 - Upgrade software of this product.
- 18 **Audio in socket**
 - Audio input from, for example, an MP3 player (3.5mm socket).
- 19 **Audio out socket**
 - Connect an audio cable (not supplied) to the Audio out socket on the unit and the audio in socket of the external device, and the unit will output audio automatically to the external device.
- 20 **AC power socket**
 - Connect to the power supply.

3 Get started

When you use this unit for the first time or unused for long periods of time, recharge the battery fully.

Note

- For identification and supply ratings, see the type plate at the back or bottom of the product.
- Before you make or change any connections, make sure that all devices are disconnected from the power outlet.

Connect to power

WARNING!

- Risk of product damage! Make sure that the power supply voltage corresponds to the voltage printed on the back or the underside of the product.
- Risk of electric shock! When you unplug the power cord, always pull the plug from the socket. Never pull the cord.
- Before connecting the AC power cord, ensure you have completed all other connections.

Connect the mains cable to the **AC in~** socket of the party speaker and then into a mains socket.

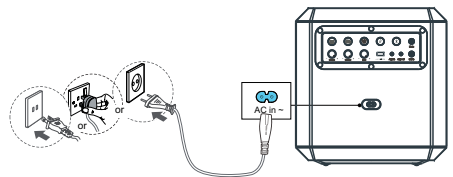

Power cord quantity and plug type vary by regions.

Turn On and Off

Press and hold  key for 3 seconds to switch on/off the unit.

Note

- The speaker will turn off automatically after 15 minutes without user operations and music playback.

Volume control

Press +/- key to increase or decrease volume level.

Tip

- While adjusting the volume, the white speaker light will move up or down for 3 sec
- When the volume meet the maximum level, the white speaker light will fully turn on for 3 sec
- When the volume meet the minimum level, the white speaker light will turn off for 3 sec

DBB control

Short press **DBB** key to switch the DBB (bass) level.

Function	LED1 (Yellow)
DBB1	LED1 flash once then solid
DBB2	LED1 flash twice then solid
DBB off	LED1 off

Charge the built-in battery

Plug the AC power cord to charge the built-in battery. The battery indicators blink in different manners to indicate the charging status.

Note

- The four indicators on the unit will go out in 15 seconds after the battery is fully charged.

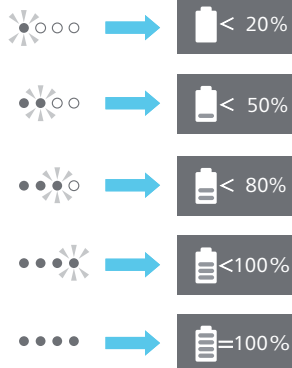
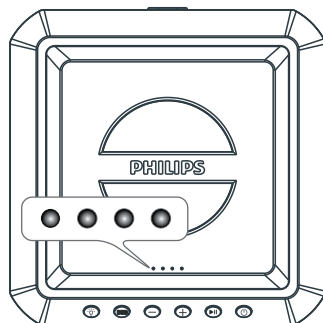

- The speaker is designed with a smart battery check feature for your convenience.
- Press  button to show the current battery level on the LED indicators of the unit in power on mode while the unit is not being charged.

Note

- When the battery level is low, all battery LED indicators will blink simultaneously and a prompt tone is heard.

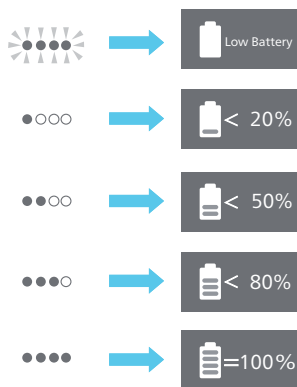
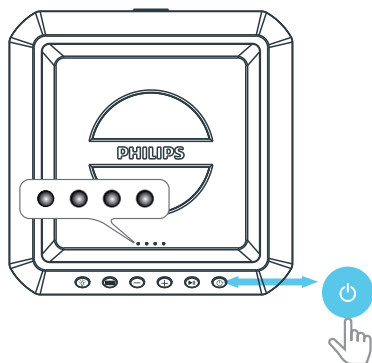

Change light effect

Turn speaker light on or off

- 1 In power on mode, press  (Light) key repeatedly to switch among different light modes of speaker light.

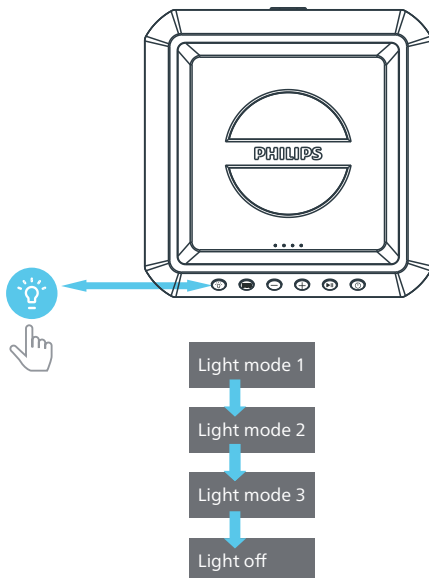

Play from Bluetooth devices



The product can stream music from your Bluetooth device to the system through Bluetooth.

Note

- A Bluetooth device which supports Bluetooth profile A2DP, AVRCP and with Bluetooth version as 5.0 + EDR.
- The maximum operational range between the party speaker and a Bluetooth device is approximately 30 meters.
- The player will also be disconnected when your device is moved beyond the operational range.
- Compatibility with all Bluetooth devices is not guaranteed.



LED3 State	Status
Blinking blue	<ul style="list-style-type: none">• Ready for Pairing• Reconnecting the last connected device
Solid blue	Connected

- 1 Press the  button to switch the party speaker to Bluetooth mode.
 - » The LED indicator (LED3) and speaker light will blink blue.
- 2 On the Bluetooth device, switch on Bluetooth, search for and select **Philips TAX4207** to start connection.
 - » During connection, the LED indicator (LED3) and speaker light will blink blue.
- 3 Wait until you hear voice prompt from the party speaker.
 - » When the speaker is connected, the LED indicator (LED3) and speaker light turn solid blue.
- 4 Select and play audio files or music on your Bluetooth device.

Button	Action
Short press 	Start, pause or resume play.
Long press 	Skip to the next track.

- 5 To exit Bluetooth, you can:
 - Switch the unit to another source.
 - Disable the function from your Bluetooth device. Or place your Bluetooth device out of the maximum operational range. The Bluetooth device will be disconnected from the unit after the voice prompt.
 - Press and hold  button until the LED indicator blinks blue.

Note

- To disconnect a device, press and hold  for 3 seconds until the LED indicator blinks blue quickly.
- When you turn on the speaker, it always automatically tries to reconnect the last successfully connected device.
- Before connecting another Bluetooth device, disconnect the current device firstly.
- When the Bluetooth device is beyond the valid Bluetooth distance, the unit will disconnect automatically from the device.
- Press and hold  button on the unit for 8 seconds to disconnect the current device and clear out the Bluetooth pairing information.

Multi-point control

The product support multi-point feature, and can connect two Bluetooth device at same time.

- There is audio prompt when the second Bluetooth device connect the party speaker.
- When the first Bluetooth device pause or disconnected, the second Bluetooth device can stream its audio to party speaker.
- Incoming call has priority over music playback regardless from first or second devices.

Note

- Under TWS and PartyLink mode, multi-point control is not supported.



Pairing for stereo mode (TWS)

Two speakers can pair with each other for stereo sound.



Note

- TWS is worked only if there are two identical party speakers (Philips TAX4207).

Select master speaker manually

- 1 Press and hold  key for 3 seconds to power on both speakers and enter to Bluetooth pairing mode.
 - » The LED indicator (LED3) on both speakers blink blue.
- 2 Select one speaker as master and connect to Bluetooth.
 - » LED3 on master speaker turns solid blue once Bluetooth is connected.
- 3 Press and hold  (TWS) button on both speakers for 3 seconds to enter stereo pairing mode (TWS).
 - » LED3 blinks blue and white alternatively on both speakers
- 4 When TWS is connected, you will hear a voice prompt.
 - » LED3 turns solid blue on both speakers.
- 5 To exit TWS, press and hold  (TWS) button on either speaker.

Select master speaker automatically

- 1 Press and hold  touch key for 3 seconds to power on both speakers.
 - » The LED indicator (LED3) on both speakers blink blue.
- 2 Press and hold  TWS button on both speakers for 3 seconds to enter stereo pairing mode.

- » The first speaker entered TWS mode is master and LED3 on master speaker turns solid blue.
- » The volume level, play/pause state, light mode in slave speaker will sync from master speaker after TWS connected.

- 3 To exit TWS, press and hold  (TWS) button on either speaker.





Note



- During TWS pairing mode, both master and slave speaker will return to previous state automatically after 1 minute without user operations or TWS pairing is not successful.

TWS playback operation

When TWS is connected, the slave speakers will synchronize from master speaker of below functions.

- Light effect
- Volume level
- Play/pause
- DBB (bass) level

Key & Operate	Action
Press  key on either speaker	Select Play/pause the music on both speakers
Press VOL + / - key on either speaker	Increase or decrease volume on both speakers
Press DBB key on either speaker	Change DBB setting on both speakers
Press and hold  key on either speaker for 3 seconds	Power off both speakers
Press and hold  key on either speaker for 3 seconds in standby state	Power on selected speaker and enter TWS reconnection
Press  key on either speaker	Change light mode in both speakers

Key & Operate	Action
Press and hold  key on either speaker for 3 seconds	Change brightness in all speakers
Press and hold  button on either speaker for 3 seconds	Exit TWS mode

PartyLink mode

The speaker can connect up to 50 party speakers together and play audio at the same time.

Enter PartyLink mode

- 1 Press and hold  key for 3 seconds to power on party speakers and enter to Bluetooth pairing mode.
 - » The LED indicator (LED3) on both speakers blink blue.
- 2 Select one speaker as master and connect to Bluetooth.
 - » LED3 on master speaker turns solid blue once Bluetooth is connected.
- 3 Press and hold **PartyLink** button on all speakers for 3 seconds to enter PartyLink pairing mode.
 - » LED4 blinks green and white alternatively on all speakers.
- 4 When PartyLink is connected, you will hear a voice prompt.
 - » LED3 on slave speakers turns solid white.
 - » LED4 remains blinking green and white alternatively on master speaker.

- » Volume level, play/pause state, light mode in slave speakers will sync from master speaker after PartyLink connected.

- 5 Press and hold **PartyLink** button on master speaker. All speakers will exit PartyLink mode.

Note

- During PartyLink pairing mode, slave speaker will return to previous state automatically after 1 minute without user operations or PartyLink pairing is not successful.
- No timeout on master speaker.

PartyLink between TAX4207 and TAX7207

You can connect TAX4207 with another party speaker TAX7207, both models have PartyLink function.

When PartyLink is connected, the slave speakers will synchronize from master speaker of below functions.

- Volume level
- Play/pause
- DBB (bass) level

PartyLink playback operation

When PartyLink is connected, the slave speakers will synchronize from master speaker of below functions.

- Light effect
- Volume level
- Play/pause
- DBB (bass) level

Key & Operate	Action
Press ▶ key on master speaker	Select Play/pause the music on all connected speakers
Press VOL + / - key on master speaker	Increase or decrease volume on all connected speakers
Press DBB key on master speaker	Change DBB setting on all speakers
Press and hold power ⏻ key on master speaker for 3 seconds	Power off master speaker, all slave speakers will exit party link mode
Press and hold ⏻ key on selected slave speaker for 3 seconds	Power off selected slave speaker, there is no effect on master speaker and other slave speakers
Press and hold ⏻ key on selected speaker in standby state	Power on selected speaker and pressing PartyLink key again to enter PartyLink mode
Press ☼ key on master speaker	Change light mode in all connected speakers
Press ☼ key on slave speakers	No change light mode in all connected speakers
Press and hold ☼ key on master speaker for 3 seconds	Change brightness in all speakers
Press PartyLink button on selected slave speaker	Disconnect selected slave speaker from master speaker
Press and hold PartyLink button on master speaker for 3 seconds	Disconnect all speakers and exit PartyLink mode

Play audio through USB

Enjoy audio on a USB storage device, such as an MP3 player and USB flash memory, etc.

Note

- Make sure that the USB device contains playable audio contents in supported formats. Supported formats: MP3, WAV, WMA, FLAC. FLAC format audio only supports not over 16 bit rate.
- The unit supports max 128G USB and file format FAT16/FAT32/exFAT.
- Support a USB port: 5V \pm 0.5A.

1 Insert the USB device.

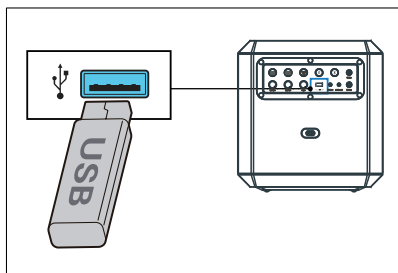

- » The unit will switch to the USB mode and play automatically.

Listen to an external device

With this product, you can listen to an external audio device such as an MP3 player.

Play from an MP3 player

- 1 Connect an audio input cable (not supplied) with a 3.5mm connector on both ends to:
 - The **Audio in** socket on the unit.
 - The headphone socket on the MP3 player.

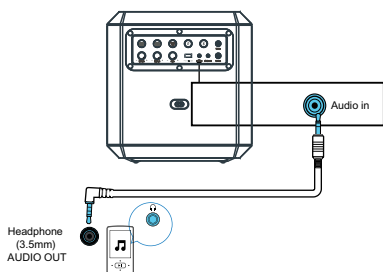

- » The unit switches to the Audio in mode automatically.

- 2 Play audio on the MP3 player (refer to its user manual).

Audio out

This unit has a Audio out socket. You can output the analog stereo audio signals to external devices such as an active speaker.

Connect an audio cable (not supplied) to the Audio out socket on the unit and the audio in socket of the external device, and the unit will output audio automatically to the external device.

Sing through microphone

Adjust microphone volume

Connect a microphone (not supplied) into the **Mic in** socket of the unit, and adjust the microphone volume by turning the **Mic vol** knob.

Now, enjoy the karaoke singing!

Adjust echo

Adjust the microphone echo level to your desired level by turning the **Echo** knob.

Vocal fader

Press the **Vocal fader** button to switch between vocal fader on and vocal fader off.

Voice changer

Press the **Voice changer** button on the panel to switch among different voice tones: Woman voice / Man voice / Children voice / Normal effect.

Factory reset

Reset device to default setting.

- 1 Turn on the party speaker, press and hold + and ►|| buttons for 10 seconds.
 - » Reset party speaker and then standby.
 - » Battery capacity LEDs flash three times.

Update firmware via USB

- 1 Check if there is the latest firmware version on www.philips.com/support. Search for your model and click on "Software and drivers"

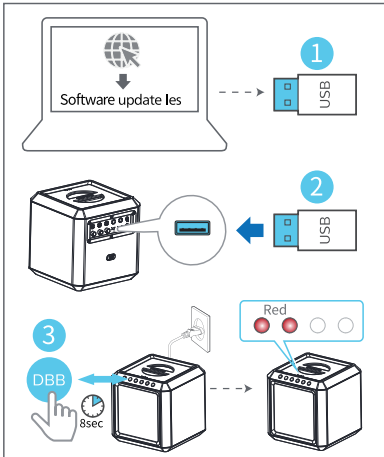

- 2 Copy the software update files into USB flash drive, insert USB flash drive on the unit.
- 3 Press and hold **DBB** key for 8 seconds in power on state with power cable plug.

LED1/2 (Red)	Status
Solid	Enter upgrade mode
Fast blinking	Upgrade start
LED off	Upgrade finished and restart

Pole-Mounting your Party speaker

- 1 Remove the cover from the bottom of the party speaker (please keep the cover).
- 2 Lift the party speaker to a speaker tripod (sold separately).
- 3 Adjust the speaker tripod to the appropriate height.

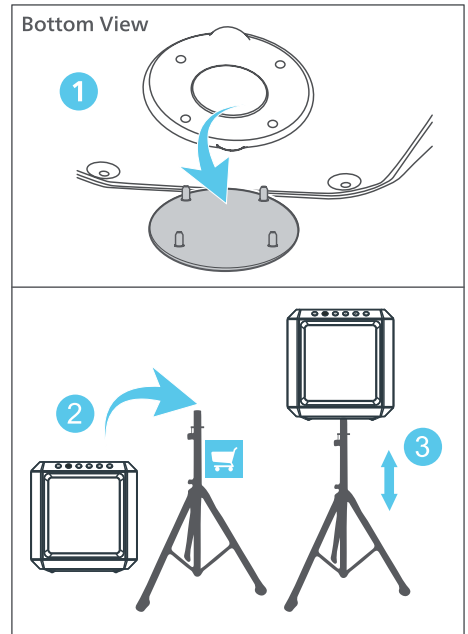

4 Product specifications



Note

- Specifications and design are subject to change without notice.

Amplifier

AC output power (RMS)	50 W
AC output power (maximum)	100 W
Battery output power	15 W
Frequency response	40Hz-20KHz, ±3dB
Signal to noise ratio	≥ 65 dBA
Total harmonic distortion	< 10%

Speaker

Speaker impedance	4 ohm + 8 ohm x 2
Sensitivity	91 dB ±3dB/m/W

Bluetooth

Bluetooth version	V 5.0
Bluetooth frequency band	2.402 GHz ~ 2.480 GHz ISM Band
Transmitter power	≤10dBm
Bluetooth range	30 m (free space)

Streaming format: SBC, music streaming (A2DP), Playback/volume control: AVRCP

USB

USB direct version	2.0 Full Speed
USB output	5V, 0.5A

Codec

Codec format	.mp3
--------------	------

Battery

Battery capacity	11.1V, 2200mAh (Built in rechargeable)
Battery life	12 hrs
Battery charge time	3hrs

General information

AC power	100-240V~ 50/60Hz, 50W
Eco standby fewer consumption	≤ 0.5W
Dimensions (WxHxD)	300x306x300 mm
Weight	5.94 kg
Operating Temperature	0°C - 45°C

5 Troubleshooting



Note

- Never remove the casing of the product.

To keep the Warranty valid, never try to repair the system yourself.

If you encounter problems when using this unit, check the following points before requesting service. If the problem remains unsolved, go to the Philips website (www.philips.com/support).

When you contact Philips, ensure that your unit is nearby and the model number and serial number are available.

No power

- Ensure that the unit is fully charged or connected with a power source.
- Ensure that all the required cables are securely connected.
- Ensure that the unit is switched on.
- To save power, the unit switches to standby automatically 15 minutes after a play reaches the end and no control is operated.

No sound

- Adjust the volume.
- Check the sound input source.

No response of button or function error

- Press and hold **Vocal fader** and **X** buttons for 10 seconds to force shutdown, then turn on the unit again to be used normally.

Cannot display some files in USB device

- The number of folders or files in the USB device has exceeded a certain limit. This phenomenon is not a malfunction.
- The formats of these files are not supported.

USB device not supported

- The USB device is incompatible with the unit. Try another one.

About Bluetooth device

The audio quality is poor after connection with a Bluetooth-enabled device

- The Bluetooth reception is poor. Move the device closer to this product or remove any obstacle between them.

Cannot connect with the device

- The Bluetooth function of the device is not enabled. Refer to the user manual of the device for how to enable the function.
- This product is already connected with another Bluetooth-enabled device. Disconnect that device and then try again.

The paired device connects and disconnects constantly

- The Bluetooth reception is poor. Move the device closer to this product or remove any obstacle between them.
- For some devices, Bluetooth connection may be deactivated automatically as a power-saving feature. This does not indicate any malfunction of this product.



Specifications are subject to change without notice. Please visit www.Philips.com/support for the latest updates and documents.

Philips and the Philips Shield Emblem are registered trademarks of Koninklijke Philips N.V. and are used under license.

This product has been manufactured by and is sold under the responsibility of MMD Hong Kong Holding Limited, or one of its affiliates, and MMD Hong Kong Holding Limited, is the warrantor in relation to this product.

TAX4207YW_UM_EN_V1.0_20220113

