

Register your product and get support at

www.philips.com/welcome

DS3600



EN User manual

PHILIPS

Contents

1	Important	3
----------	------------------	----------

2	Your Docking Speaker	4
	Introduction	4
	What's in the box	4
	Overview of the main unit	5
	Overview of the remote control	6

3	Get started	6
	Prepare the remote control	6
	Connect power	6
	Turn on	7

4	Play	7
	Play from iPod/iPhone/iPad	7
	Play from Bluetooth devices	9
	Play from an external audio device	10
	Adjust volume	10
	Mute sound	10

5	Specifications	11
	Amplifier	11
	Bluetooth	11
	General information	11

6	Troubleshooting	11
	About Bluetooth device	12

7	Notice	12
----------	---------------	-----------

1 Important

- Read these instructions.
- Heed all warnings.
- Follow all instructions.
- Do not use this apparatus near water.
- Do not block any ventilation openings. Install in accordance with the manufacturer's instructions.
- Do not install near any heat sources such as radiators, heat registers, stoves, or other apparatus (including amplifiers) that produce heat.
- Protect the power cord from being walked on or pinched, particularly at plugs, convenience receptacles, and the point where they exit from the apparatus.
- Only use attachments/accessories specified by the manufacturer.
- Unplug this apparatus during lightning storms or when unused for long periods of time.
- Refer all servicing to qualified service personnel. Servicing is required when the apparatus has been damaged in any way, such as power-supply cord or plug is damaged, liquid has been spilled or objects have fallen into the apparatus, the apparatus has been exposed to rain or moisture, does not operate normally, or has been dropped.
- Keep the battery away from heat, sunshine or fire. Never discard battery in fire.
- Replace the battery with the same or equivalent type only.
- The battery contains chemical substances, so it should be disposed of properly.
- The button cell battery cannot be swallowed. Keep children away from the battery.
- Apparatus shall not be exposed to dripping or splashing.
- Do not place any sources of danger on the apparatus (e.g. liquid filled objects, lighted candles).

- The USB socket is for data transmission only.
- Where the plug of the Direct Plug-in Adapter is used as the disconnect device, the disconnect device shall remain readily operable.



Warning

- Never remove the casing of this apparatus.
- Never place this apparatus on other electrical equipment.
- Ensure that you always have easy access to the power cord, plug or adaptor to disconnect the apparatus from the power.

2 Your Docking Speaker

Congratulations on your purchase, and welcome to Philips! To fully benefit from the support that Philips offers, register your product at www.philips.com/welcome.

If you contact Philips, you will be asked for the model and serial number of this apparatus. The model number and serial number are on the bottom of the apparatus. Write the numbers here:

Model No. _____

Serial No. _____

Introduction

With this docking speaker, you can

- enjoy audio from the iPod/iPhone/iPad, Bluetooth devices and other external audio devices; and
- synchronize the iPod/iPhone/iPad with your computer through USB socket.

What's in the box

Check and identify the contents of your package:

- Main unit
- Remote control (with battery)
- 1 x AC power adaptor
- Quick start guide
- Safety sheet

Overview of the main unit

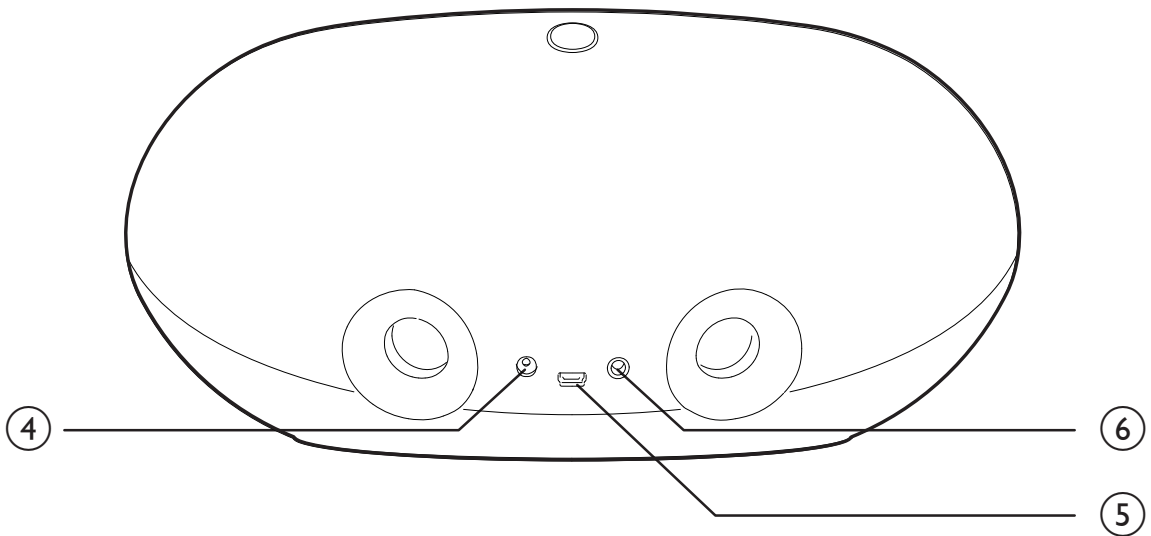
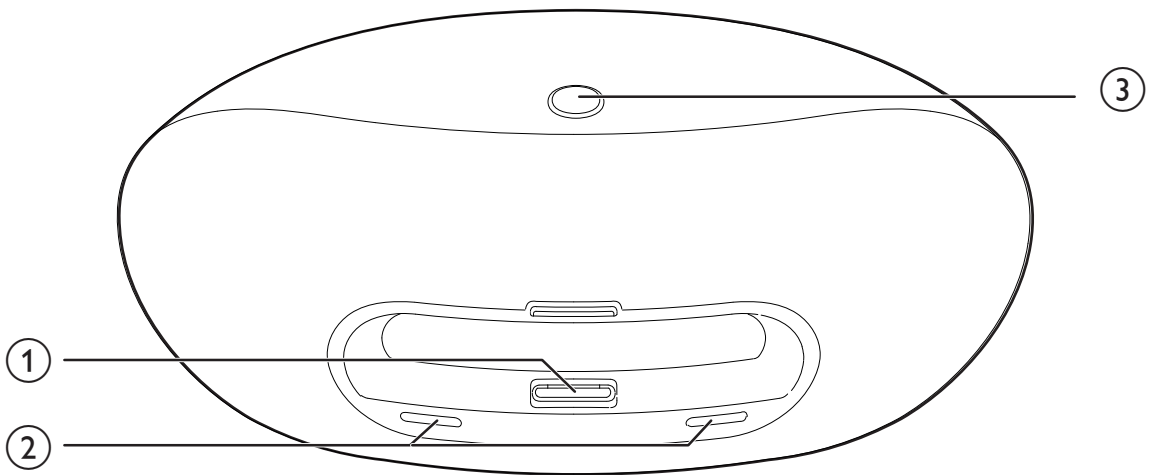

① Dock for the iPod/iPhone/iPad

② + / -

- Adjust volume.
- As LED indicators, show system status.

③ *

- Select Bluetooth mode.
- Turn the docking speaker on.
- Switch to standby mode.

④ Power supply socket

- Connect AC power.

⑤ 

- Sync with PC through a USB cable.

⑥ MP3-LINK

- Connect an external audio device.

Overview of the remote control

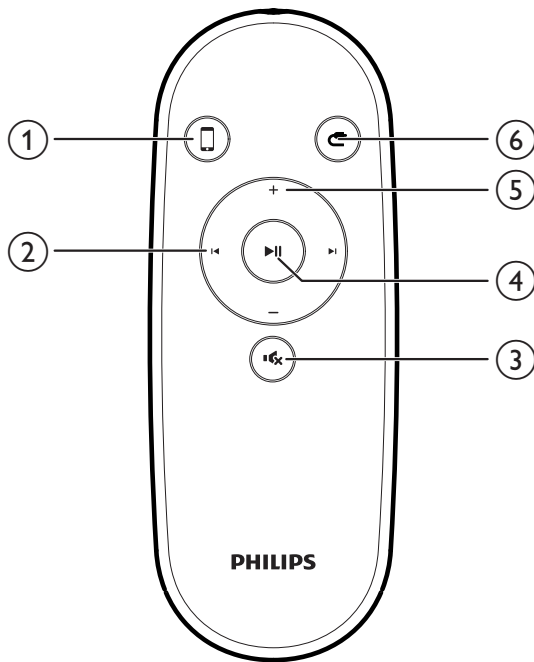

- ①
 - Select iPod/iPhone/iPad mode.
- ②
 - Skip to a track.
 - Search within play.
- ③
 - Mute volume.
- ④
 - Start or pause play.
- ⑤
 - Adjust volume.
- ⑥
 - Select MP3 link mode.

3 Get started

Always follow the instructions in this chapter in sequence.

Prepare the remote control

For first-time use:

Remove the protective tab to activate the remote control battery.

To replace the exhausted battery:

- 1 Open the battery tray.
- 2 Insert one CR2025 battery with correct polarity (+/-) as indicated.
- 3 Close the battery tray.

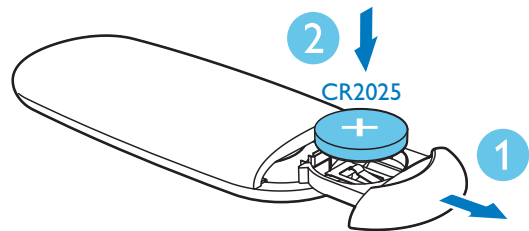

Connect power



Caution

- Risk of product damage! Make sure that the power supply voltage matches the voltage printed on the bottom of the docking speaker.
- Risk of electric shock! When you unplug the AC adaptor, always pull the plug from the socket. Never pull the cord.



Note

- The type plate is located at the back of the docking speaker.

Connect the AC power adaptor to:

- the **DC IN** socket at the back of the docking speaker.
- the wall outlet.

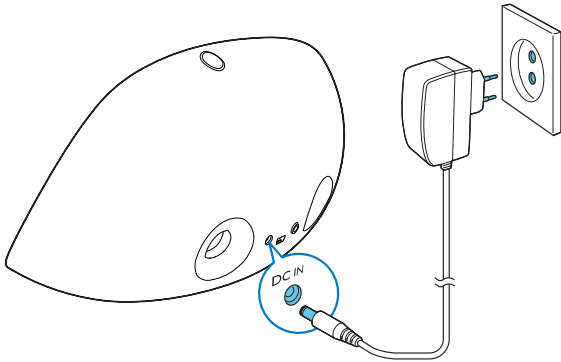

Turn on

Press and hold **⌘** on the main unit for 2 seconds.

↳ The + / - LED indicators light up.

Switch to standby mode

In the following situation, the docking speaker switches to standby mode:

- Press and hold **⌘** for 2 seconds again; or
- The system is idle for 15 minutes.

↳ In standby mode, the LED indicators light off.

Note

- In standby mode, if you press **⌘** on the main unit or **⏪** / **⏩** on the remote control, the docking speaker switches to the corresponding selected source.

4 Play

Play from iPod/iPhone/iPad

You can enjoy audio from iPod/iPhone/iPad through this docking speaker.

Compatible iPod/iPhone/iPad

The docking speaker supports the following iPod/iPhone/iPad models:

Made for:

- iPod touch (1st, 2nd, 3rd, and 4th generation)
- iPod nano (1st, 2nd, 3rd, 4th, 5th, and 6th generation)
- iPhone 4S
- iPhone 4
- iPhone 3GS
- iPhone 3G
- iPhone
- iPad 2
- iPad

Listen to the iPod/iPhone/iPad

Philips **DockStudio** app brings a suite of new features to your docking speaker. To enjoy more features, you are recommended to install this free application.

- 1 Insert your iPod/iPhone/iPad into the dock.
 - ↳ The docking system switches to Dock source automatically.
 - ↳ The orange LED indicators light up.

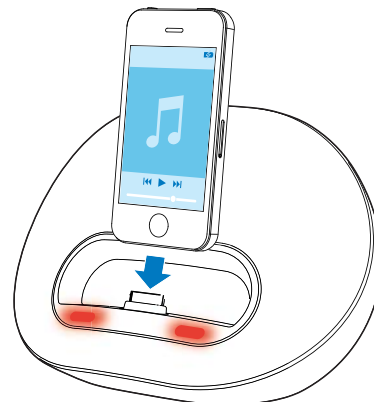

- 2 For first-time use, you will be asked to install **DockStudio** app on your iPod/iPhone/iPad.
- 3 Tap **[Yes]** (yes) to accept the installation request.
- 4 Follow the on-screen instructions to complete the installation.



- 5 Launch the app after the installation.
- 6 Play audio on your iPod/iPhone/iPad.
 - ↳ Audio comes out through this docking speaker.



Tip

- You can press  to select Dock source.
- With the **DockStudio** app, you can enjoy music, set clock and alarm, adjust sound settings, update firmware, and so on.

- To pause or resume play, press **▶||**.
- To skip to a track, press **◀|** / **|▶**.
- To search during play, press and hold **◀|** / **|▶**, then release to resume normal play.

Update firmware

If firmware update is available, the **DockStudio** app will search for it automatically and ask you to download it.



Note

- Make sure that your iPod/iPhone/iPad is inserted in the docking speaker and connected to the Internet.

- 1 If a new firmware update is found, tap **OK**.



- 2 Follow the on-screen instructions to complete the firmware update.





Note

- Do not disconnect power or undock the iPod/iPhone/iPad during the updating process.

Charge the iPod/iPhone/iPad

When the docking speaker is connected to power, the docked iPod/iPhone/iPad begins to charge automatically.

Sync iPod/iPhone/iPad with PC

Note

- Make sure that iTunes has been configured properly in your PC.

- 1 Insert the iPod/iPhone/iPad in the dock.
- 2 Press and hold **⌘** for 2 seconds to switch the docking speaker to standby mode.
↳ The LED indicators light off.
- 3 Connect your docking speaker and PC with a USB cable.

- 4 Launch iTunes to synchronize your docking speaker with PC.
↳ The docked iPod/iPhone/iPad is synchronized with PC successfully through the iTunes.

Note

- Due to different materials and product techniques, some USB cables may not work with this device.

Play from Bluetooth devices

Note

- Before you connect a Bluetooth device to this docking speaker, familiarize yourself with the Bluetooth capabilities of the device.
- Keep this docking speaker away from other electronic devices that may cause interference.
- The effective operation range between the docking speaker and the paired device is approximately 10 meters (30 feet).
- Any obstacle between the speaker and the device can reduce the operational range.

- 1 Press **⌘** to select Bluetooth source.
↳ The blue Bluetooth indicator flashes slowly.
- 2 Turn on Bluetooth function on your device.
 - Different devices may have different way to activate Bluetooth.

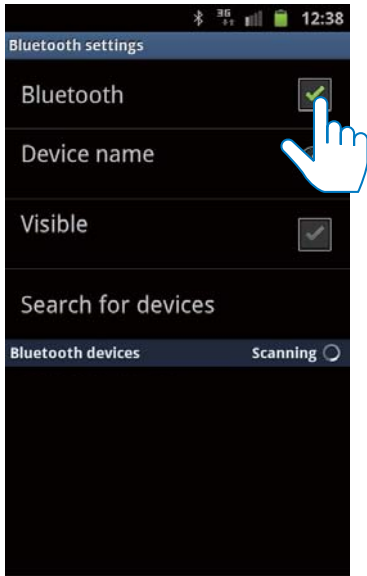

- 3 Scan Bluetooth devices that can pair with your device.
- 4 When “PHILIPS DS3600” is displayed on your device, select it to start connection.
 - ↳ Double beep tone confirmation can be heard and the Bluetooth indicator light up stably if connection is successful.
- 5 Play music in your device.
 - ↳ Music comes through the docking speaker.



Tip

- If your Bluetooth device has been paired with DS3600 before, you just need to find out “PHILIPS DS3600” on your Bluetooth menu, then confirm the connection.

To disconnect Bluetooth:

- Press **⌘** on the docking speaker again, or
- Deactivate Bluetooth function on your device or move it beyond the communication range.

Play from an external audio device

- 1 If no iPod/iPhone/iPad is docked, connect an MP3 link cable (3.5mm, not supplied) to:
 - the **MP3-LINK** socket at the back of the docking speaker.
 - the headphone socket on an external device.
- 2 Play music on the device (see the device’s user manual).



Tip

- You can select MP3 link source by pressing **⏮** on the remote control.

Adjust volume

To adjust volume:

- Press **+/-** on your docking speaker; or
- Adjust the volume control of your iPod/iPhone/iPad, Bluetooth device, or other external device.

Mute sound

During play, press **⏸** to mute or unmute sound.

5 Specifications

Note

- Product information is subject to change without prior notice.

Amplifier

Rated Output Power	2 X 10 W RMS
Signal to Noise Ratio	> 62 dBA
Aux-in Link	500mV RMS

Bluetooth

Standard	Bluetooth Standard Version 2.1+EDR
Output power	0 dBm (Class 2)
Frequency band	2.402 ~ 2.480 GHzISM Band
Range	10 m (free space)

General information

AC Power	Model: AS300-120-AE250 (Philips); Input: 100-240 V ~, 50/60Hz, 1.1A; Output: 12 V == 2.5 A
Operation Power Consumption	15 W
Standby Power Consumption	<0.5 W
Max. load for iPod/iPhone/iPad	5 V == 2.1 A
Dimensions - Main Unit (W x H x D)	285 x 136 x 143 mm
Weight - Main Unit - With Packing	1.2 kg 2.1 kg

6 Troubleshooting

Warning

- Never remove the casing of this apparatus.

To keep the warranty valid, never try to repair the system yourself.

If you encounter problems when using this apparatus, check the following points before requesting service. If the problem remains unsolved, go to the Philips web site (www.philips.com/welcome). When you contact Philips, ensure that the apparatus is nearby and the model number and serial number are available.

No power

- Ensure that the AC power plug of the unit is connected properly.
- Ensure that there is power at the AC outlet.

No sound or poor sound

- Adjust the volume of your docking speaker.
- Adjust the volume of your iPod/iPhone/iPad, Bluetooth devices or other external devices.

No response from the unit

- Disconnect and reconnect the AC power plug, then turn on the unit again.

Cannot sync with PC

- Switch the docking speaker to standby mode.
- Try another USB cable.
- Install iTunes in PC properly.

About Bluetooth device

Music playback is unavailable on the system even after successful Bluetooth connection.

- The device cannot be used with the system to play music.

The audio quality is poor after connection with a Bluetooth-enabled device.

- The Bluetooth reception is poor. Move the device closer to the system or remove any obstacle between the device and the system.

Cannot connect with the system.

- The device does not support the profiles required for the system.
- The Bluetooth function of the device is not enabled. Refer to the user manual of the device for how to enable the function.
- The system is not in the pairing mode.
- The system is already connected with another Bluetooth-enabled device. Disconnect that device or all other connected devices and then try again.

The paired device connects and disconnects constantly.

- The Bluetooth reception is poor. Move the device closer to the system or remove any obstacle between the device and the system.
- For some devices, the Bluetooth connection may be deactivated automatically as a power-saving feature. This does not indicate any malfunction of the system.

7 Notice

Any changes or modifications made to this device that are not expressly approved by Philips Consumer Lifestyle may void the user's authority to operate the equipment.



"Made for iPod," "Made for iPhone," and "Made for iPad" mean that an electronic accessory has been designed to connect specifically to iPod, iPhone, or iPad, respectively, and has been certified by the developer to meet Apple performance standards. Apple is not responsible for the operation of this device or its compliance with safety and regulatory standards. Please note that the use of this accessory with iPod, iPhone, or iPad may affect wireless performance.

iPod and iPhone are trademarks of Apple Inc., registered in the U.S. and other countries. iPad is a trademark of Apple Inc.

CE 2150

This product complies with the radio interference requirements of the European Community.



Your product is designed and manufactured with high quality materials and components, which can be recycled and reused.



When this crossed-out wheeled bin symbol is attached to a product it means that the product is covered by the European Directive 2002/96/EC.

Please inform yourself about the local separate collection system for electrical and electronic products.

Please act according to your local rules and do not dispose of your old products with your normal household waste. Correct disposal of your old product helps to prevent potential negative consequences for the environment and human health.



Your product contains batteries covered by the European Directive 2006/66/EC, which cannot be disposed with normal household waste. Please inform yourself about the local rules on separate collection of batteries because correct disposal helps to prevent negative consequences for the environmental and human health.

Environmental information

All unnecessary packaging has been omitted. We have tried to make the packaging easy to separate into three materials: cardboard (box), polystyrene foam (buffer) and polyethylene (bags, protective foam sheet.)

Your system consists of materials which can be recycled and reused if disassembled by a specialized company. Please observe the local regulations regarding the disposal of packaging materials, exhausted batteries and old equipment.



Specifications are subject to change without notice
© 2012 Koninklijke Philips Electronics N.V.
All rights reserved.

DS3600_12_UM_V1.0

