

Stereo Radio Cassette Recorder

AQ5130

Register your product and get support at
www.philips.com/welcome

User Manual

用戶手冊



PHILIPS

1

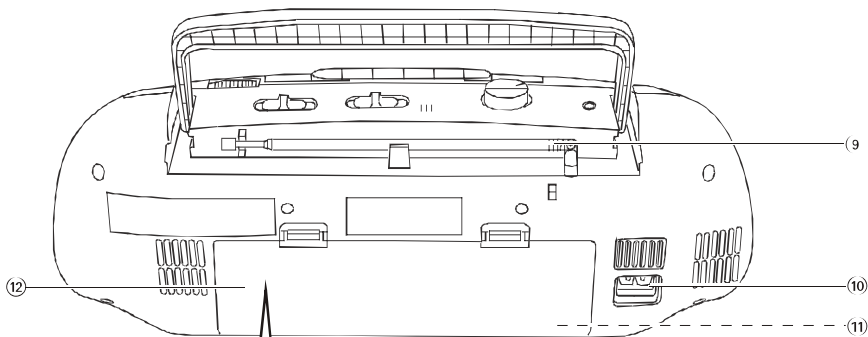
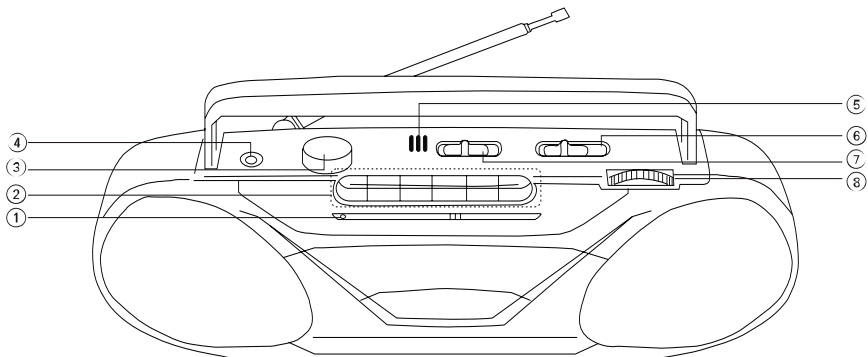

6 x SUM-1 • D-CELLS • HP 2 • R20

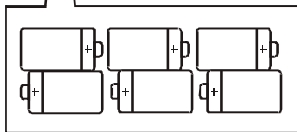

Congratulations on your purchase and welcome to Philips!

To fully benefit from the support that Philips offers, register your product at www.philips.com/welcome.

Supplied accessories

– AC power cord

Top and front panels (See **1**)

- ① **FM STEREO indicator** – lights up for stereo FM reception.
 - ② **Cassette recorder keys:**
 - PAUSE II** – pauses playback or recording
 - STOP•EJECT ■▲**
 - stops playback or recording.
 - opens the cassette holder.
 - F. FWD/REWIND ◀◀ or ▶▶**
 - fast winds/rewinds the tape
 - PLAY ◀** – starts playback
 - RECORD ●** – starts recording
 - ③ **VOLUME rotary** – adjusts volume level
 - ④ **📞** - 3.5mm stereo headphone jack
- Helpful hints:**
- *Connecting the headphones will switch off the speakers.*
- ⑤ **MIC (built-in microphone)**
 - for voice recording
 - ⑥ **Band selector: MW, FM**
 - selects wavebands, MW or FM
 - ⑦ **Source selector: TAPE, RADIO**
 - selects tape or radio source of sound
 - switches off the set
 - ⑧ **TUNING rotary** – tunes to radio stations

Back panel (See **1**)

- ⑨ **Telescopic antenna**
 - improves FM reception.
- ⑩ **AC INPUT** - inlet for power cord
- ⑪ **Voltage selector** – (inside the battery compartment, not for all versions) adjust to match the local voltage 110/220V before plugging in the set.
- ⑫ **Battery door** - open to insert 6 X 1.5 batteries, type **R20** or **D-cells**

Power supply

Whenever convenient, use the power cord if you want to conserve battery life. Make sure you remove the plug from the set and wall outlet before inserting batteries.

Batteries (not included)

- Insert 6 batteries, type **R20** or **D-cells** (preferably alkaline) with the correct polarity. (See **1**)

Batteries contain chemical substances, so they should be disposed of properly.

- Incorrect use of batteries can cause electrolyte leakage and will corrode the compartment or cause the batteries to burst.
- Do not mix battery types: e.g. alkaline with carbon zinc. Only use batteries of the same type for the set.
- When inserting new batteries, do not try to mix old batteries with the new ones.
- Remove the batteries if the set is not to be used for a long time.

Using AC power

- 1 Check if the power voltage, as shown on the **type plate located on the bottom of the set**, corresponds to your local power supply. If it does not, consult your dealer or service center.
- 2 If your set is equipped with a voltage selector, adjust the selector so that it matches with the local mains.
- 3 Connect the power cord to the **AC INPUT** inlet and the wall socket. The power cord is now connected and ready for use.
- 4 To switch the set off completely, withdraw the power cord from the wall socket.
 - Disconnect the power cord from the wall socket to protect your set during heavy thunderstorms.

Helpful hints : To avoid unnecessary energy consumption, always adjust the **Source selector** to **TAPE** after using the set. Also check that the tape deck keys are released.

The type plate is located on the bottom of the set.

CAUTION

Use of controls or adjustments or performance of procedures other than herein may result in hazardous radiation exposure or other unsafe operation.

General operation

Switching on and off and selecting functions

- 1 To switch on, push the **Source selector** slider to **TAPE** or **RADIO** as desired.
- 2 To switch off, push the **Source selector** to **TAPE** and check the cassette keys are released.

Helpful hints:

- To change from **TAPE** to **RADIO**, or when you are switching off the set: first, make sure you press the **STOP•EJECT**  key to end playback and all the cassette keys are released.

Adjusting volume

- Adjust the volume with the **VOLUME** control.

Radio reception









- 1 Adjust the **source selector** to **RADIO**.
- 2 Adjust the **band selector** to select your desired waveband, **MW** or **FM**.
- 3 Turn **TUNING** to tune to a station.
 - **FM STEREO** lights up for stereo FM reception.
- 4 To switch off the radio, adjust the source selector to **TAPE** position.

To improve radio reception:

- For **FM**, extend and turn the telescopic antenna for best reception. Reduce its length if the signal is too strong.
- For **MW**, the set uses a built-in antenna. Direct this antenna for best reception by turning the whole set.

Cassette Recorder

Cassette playback

- 1 Push the **Source selector** to **TAPE**
- 2 Press **STOP•EJECT**  to open the cassette holder and insert a cassette and close the deck.
- 3 Press **PLAY**  to start playback.
- 4 To pause playback press **PAUSE II**
To resume, press the key again.
- 5 By pressing **F.FWD/REWIND**  or , fast forwarding/rewinding of the tape is possible in both directions. To stop fast winding, press / .
- 6 To stop the tape, press / .

Helpful hints:

- During playback, the keys are automatically released at the end of a tape and the set is switched off (unless **PAUSE II** mode has been activated.)
- During fast forwarding/rewinding, the keys will not be released at the end of a tape. To switch off the set, make sure the cassette keys are also released.

The making of unauthorized copies of copy-protected material, including computer programmes, files, broadcasts and sound recordings, may be an infringement of copyrights and constitute a criminal offence. This equipment should not be used for such purposes.







Be responsible
Respect copyrights

General information on recording

- Recording is permissible insofar as copyright or other rights of third parties are not infringed.
- For recording, use only **NORMAL** type cassettes (IEC type I) on which the tabs have not yet been broken. This deck is not suited for recording on **CHROME** (IEC II) or **METAL** (IEC IV) type cassettes.
- The best recording level is set automatically. Altering the **VOLUME** will not affect the recording.
- To protect a tape from accidental erasure, break out the tabs. If you wish to record again, cover the tabs with a piece of adhesive tape.

Recording from the Radio

- 1 Select **RADIO** source.
- 2 Tune to the desired radio station (see **Radio reception**).
- 3 Press  to open the cassette holder. Insert a blank tape and close the deck.
- 4 Press **REC**  to start recording.
- 5 For brief interruptions press **II**
To resume recording, press **II** again.
- 6 To stop recording, press / .





Making your recording

- 1 Select **TAPE** source.
- 2 Follows steps 3-4 under **Recording from the Radio**.
- 3 Speak towards the built-in microphone **MIC** (see ).
- 4 Follows steps 6-7 under **Recording from the Radio**.

Maintenance & safety

Tape deck maintenance

To ensure quality recording and playback of the tape deck, clean parts (A), (B) and (C) as shown, once a month. Use a cotton bud slightly moistened with alcohol or a special head cleaning fluid to clean the deck.

- 1 Open the cassette holder by pressing .
 - 2 Press  and clean the roller (C).
 - 3 Press  and clean the heads (A), and the capstan (B).
 - 4 After cleaning, press .
- Cleaning of the heads can also be done by playing a cleaning cassette through once.

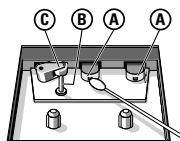

Safety information

- Place the set on a flat, hard and stable surface so that the system does not tilt.
- Where the MAINS plug or an appliance coupler is used as the disconnet device, the disconnet device shall remain readily operable.
- Do not expose the set, batteries to humidity, rain, sand or excessive heat caused by heating equipment or direct sunlight.
- The apparatus shall not be exposed to dripping or splashing.
- Adequate ventilation with a minimum gap of 15cm (6 inches) between the ventilation holes and surrounding surfaces is necessary to prevent heat build-up.
- Do not cover the ventilation openings with items such as newspapers, table-cloths, curtains, etc.
- No objects filled with liquids, such as vases, shall be placed on the apparatus.
- No naked flame sources, such as lighted candles, should be placed on the apparatus.
- The mechanical parts of the set contain self-lubricating bearings and must not be oiled or lubricated.
- To clean the set, use a dry cloth. Do not use any cleaning agents containing alcohol, ammonia, benzene or abrasives as these may harm the housing.

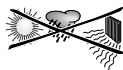

Hearing Safety

Listen at a moderate volume.

- Using headphones at a high volume can impair your hearing. This product can produce sounds in decibel ranges that may cause hearing loss for a normal person, even for exposure less than a minute. The higher decibel ranges are offered for those that may have already experienced some hearing loss.
- Sound can be deceiving. Over time your hearing "comfort level" adapts to higher volumes of sound. So after prolonged listening, what sounds "normal" can actually be loud and harmful to your hearing. To guard against this, set your volume to a safe level before your hearing adapts and leave it there.

To establish a safe volume level:

- Set your volume control at a low setting.
- Slowly increase the sound until you can hear it comfortably and clearly, without distortion.

Listen for reasonable periods of time:

- Prolonged exposure to sound, even at normally "safe" levels, can also cause hearing loss.
- Be sure to use your equipment reasonably and take appropriate breaks.

Be sure to observe the following guidelines when using your headphones.

- Listen at reasonable volumes for reasonable periods of time.
- Be careful not to adjust the volume as your hearing adapts.
- Do not turn up the volume so high that you can't hear what's around you.
- You should use caution or temporarily discontinue use in potentially hazardous situations.
- Do not use headphones while operating a motorized vehicle, cycling, skateboarding, etc.; it may create a traffic hazard and is illegal in many areas.

Troubleshooting

If a fault occurs, first check the points listed below before taking the set for repair.

If you are unable to remedy a problem by following these hints, consult your dealer or service centre.

WARNING: *Do not open the set as there is a risk of electric shock. Under no circumstances should you try to repair the set yourself, as this will invalidate the guarantee.*

Problem

- Possible cause
- Remedy

No sound /power

- Volume not adjusted
- Adjust the VOLUME
- Power cord not securely connected
- Connect the AC power cord properly
- Batteries dead/ incorrectly inserted
- Insert (fresh) batteries correctly
- Headphones connected to the set
- Disconnect headphones.

Display does not function properly/

No reaction to operation of any of the controls

- Electrostatic discharge
- Switch off and unplug the set. Reconnect after a few seconds

Severe radio hum or noise

- Electrical interference: set too close to TV, VCR or computer
- Increase the distance

Poor radio reception

- Weak radio signal
- FM: Adjust the FM telescopic antenna
- MW: Direct this antenna for best reception by turning the whole set.

Poor cassette sound quality

- Dust and dirt on the heads, etc.
- Clean deck parts, see Maintenance
- Use of incompatible cassette types (METAL or CHROME)
- Only use NORMAL (IEC I) for recording

Recording does not work

- Cassette tab(s) may be broken
- Apply adhesive tape over the missing tab space

Environmental information

All unnecessary packaging material has been omitted. The packaging can be easily separated into three materials: cardboard, polystyrene and plastic.

Your set consists of materials which can be recycled if disassembled by a specialized company. Please observe the local regulations regarding the disposal of packaging, dead batteries and old equipment.

English

中文

Meet Philips at the Internet

<http://www.philips.com>

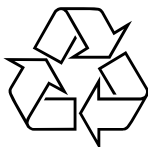

AQ5130



Printed in China

PDCC-2010