

Always there to help you

Register your product and get support at
www.philips.com/support



FWP3200D



User manual

PHILIPS

Contents

1 Important	2
Safety	2
Notice	3

2 Your Mini Hi-Fi System	5
Introduction	5
What's in the box	5
Overview of the main unit	6
Overview of the remote control	7

3 Get started	9
Prepare the remote control	9
Connect power	9
Turn on	9

4 Play	10
Basic play operations	10
Play from iPod/iPhone	10
Play from USB	12
Play options	12

5 Listen to radio	13
Tune to radio stations	13
Store radio stations	13
Select a preset radio station	13

6 Adjust sound	14
Adjust speaker volume	14
Select a sound effect	14
Mute sound	14
Select an audio output mode	14

7 Additional features	15
Play audio from an external device	15
Speak or sing through the Hi-Fi system	15
Enjoy simultaneous play	16
Adjust decoration light	16

8 Product information	17
Specifications	17
USB playability information	17

9 Troubleshooting	18
--------------------------	----

1 Important



Safety

Important Safety Instructions

- ① Read these instructions.
- ② Keep these instructions.
- ③ Heed all warnings.
- ④ Follow all instructions.
- ⑤ Do not use this apparatus near water.
- ⑥ Clean only with dry cloth.
- ⑦ Do not block any ventilation openings. Install in accordance with the manufacturer's instructions.
- ⑧ Do not install near any heat sources such as radiators, heat registers, stoves, or other apparatus (including amplifiers) that produce heat.
- ⑨ Protect the power cord from being walked on or pinched, particularly at plugs, convenience receptacles, and the point where they exit from the apparatus.
- ⑩ Only use attachments/accessories specified by the manufacturer.
- ⑪ Use only with the cart, stand, tripod, bracket, or table specified by the manufacturer or sold with the apparatus. When a cart is used, use caution when moving the cart/apparatus combination to avoid injury from tip-over.
- ⑫ Unplug this apparatus during lightning storms or when unused for long periods of time.
- ⑬ Refer all servicing to qualified service personnel. Servicing is required when the apparatus has been damaged in any way, such as power-supply cord or plug is damaged, liquid has been spilled or objects have fallen into the apparatus, the apparatus has been exposed to rain or moisture, does not operate normally, or has been dropped.
- ⑭ **Battery usage CAUTION** – To prevent battery leakage which may result in bodily injury, property damage, or damage to the unit:
 - Install all batteries correctly, + and - as marked on the unit.
 - Do not mix batteries (old and new or carbon and alkaline, etc.).
 - Remove batteries when the unit is not used for a long time.
- ⑮ Apparatus shall not be exposed to dripping or splashing.
- ⑯ Do not place any sources of danger on the apparatus (e.g. liquid filled objects, lighted candles).
- ⑰ Where the MAINS plug or an appliance coupler is used as the disconnect device, the disconnect device shall remain readily operable.

Risk of overheating! Never install this apparatus in a confined space. Always leave a space of at least four inches around this apparatus for ventilation. Ensure curtains or other objects never cover the ventilation slots on this apparatus.

Warning

- Never remove the casing of this unit.
- Never lubricate any part of this unit.
- Place this unit on a flat, hard and stable surface.
- Never place this unit on other electrical equipment.
- Only use this unit indoors. Keep this unit away from water, moisture and liquid-filled objects.
- Keep this unit away from direct sunlight, naked flames or heat.

- Use this product in the areas of an altitude of no more than 2000 meters only.
- Use this product in the non-tropical regions only.



Be sure to observe the following guidelines when using your headphones.

- Listen at reasonable volumes for reasonable periods of time.
- Be careful not to adjust the volume as your hearing adapts.
- Do not turn up the volume so high that you can't hear what's around you.
- You should use caution or temporarily discontinue use in potentially hazardous situations. Do not use headphones while operating a motorized vehicle, cycling, skateboarding, etc.; it may create a traffic hazard and is illegal in many areas.

Hearing safety

Listen at a moderate volume.

- Using headphones at a high volume can impair your hearing. This product can produce sounds in decibel ranges that may cause hearing loss for a normal person, even for exposure less than a minute. The higher decibel ranges are offered for those that may have already experienced some hearing loss.
- Sound can be deceiving. Over time your hearing 'comfort level' adapts to higher volumes of sound. So after prolonged listening, what sounds 'normal' can actually be loud and harmful to your hearing. To guard against this, set your volume to a safe level before your hearing adapts and leave it there.

To establish a safe volume level:

- Set your volume control at a low setting.
- Slowly increase the sound until you can hear it comfortably and clearly, without distortion.

Listen for reasonable periods of time:

- Prolonged exposure to sound, even at normally 'safe' levels, can also cause hearing loss.
- Be sure to use your equipment reasonably and take appropriate breaks.

Notice

Any changes or modifications made to this device that are not expressly approved by WOOX Innovations may void the user's authority to operate the equipment. Specifications are subject to change without notice. WOOX reserves the right to change products at any time without being obliged to adjust earlier supplies accordingly. Your product is designed and manufactured with high quality materials and components, which can be recycled and reused. Never dispose of your product with other household waste. Please inform yourself about the local rules on the separate collection of electrical and electronic products and batteries. The correct disposal of these products helps prevent potentially negative consequences on the environment and human health. Your product contains batteries, which cannot be disposed of with normal household waste. Please inform yourself about the local rules on separate collection of batteries. The correct disposal of batteries helps prevent potentially negative consequences on the environment and human health. Please visit www.recycle.philips.com for additional information on a recycling center in your area.



Be responsible Respect copyrights



Note

- The type plate is located on the back of the device.

The making of unauthorized copies of copy-protected material, including computer programs, files, broadcasts and sound recordings, may be an infringement of copyrights and constitute a criminal offence. This equipment should not be used for such purposes.

Environmental information

All unnecessary packaging has been omitted. We have tried to make the packaging easy to separate into three materials: cardboard (box), polystyrene foam (buffer) and polyethylene (bags, protective foam sheet.)

Your system consists of materials which can be recycled and reused if disassembled by a specialized company. Please observe the local regulations regarding the disposal of packaging materials, exhausted batteries and old equipment.

Philips and the Philips' Shield Emblem are registered trademarks of Koninklijke Philips N.V. and are used by WOOX Innovations Limited under license from Koninklijke Philips N.V.

Made for



iPod



iPhone

“Made for iPod” and “Made for iPhone” mean that an electronic accessory has been designed to connect specifically to iPod or iPhone respectively, and has been certified by the developer to meet Apple performance standards. Apple is not responsible for the operation of this device or its compliance with safety and regulatory standards. Please note that the use of this accessory with iPod or iPhone may affect wireless performance. iPod and iPhone are trademarks of Apple Inc., registered in the U.S. and other countries.

2 Your Mini Hi-Fi System

Congratulations on your purchase, and welcome to Philips! To fully benefit from the support that Philips offers, register your product at www.philips.com/welcome.

Introduction

With this Hi-Fi system, you can:

- enjoy audio from your iPod/iPhone, USB storage devices, or other external devices
- charge your iPod/iPhone through the dual rotatable docks
- swap play between the dual audio sources with the channel fader
- listen to FM radio stations
- speak or sing with microphones through the loudspeakers of the unit

To enrich sound, this Hi-Fi system offers you these sound effects:

- Digital Sound Control (DSC)
- Dynamic Bass Boost (DBB)
- Max Sound for instant power boost

What's in the box

Check and identify the contents of your package:

- Main unit
- Remote control (with batteries)
- Power cord
- FM antenna
- User manual
- Quick start guide

Overview of the main unit

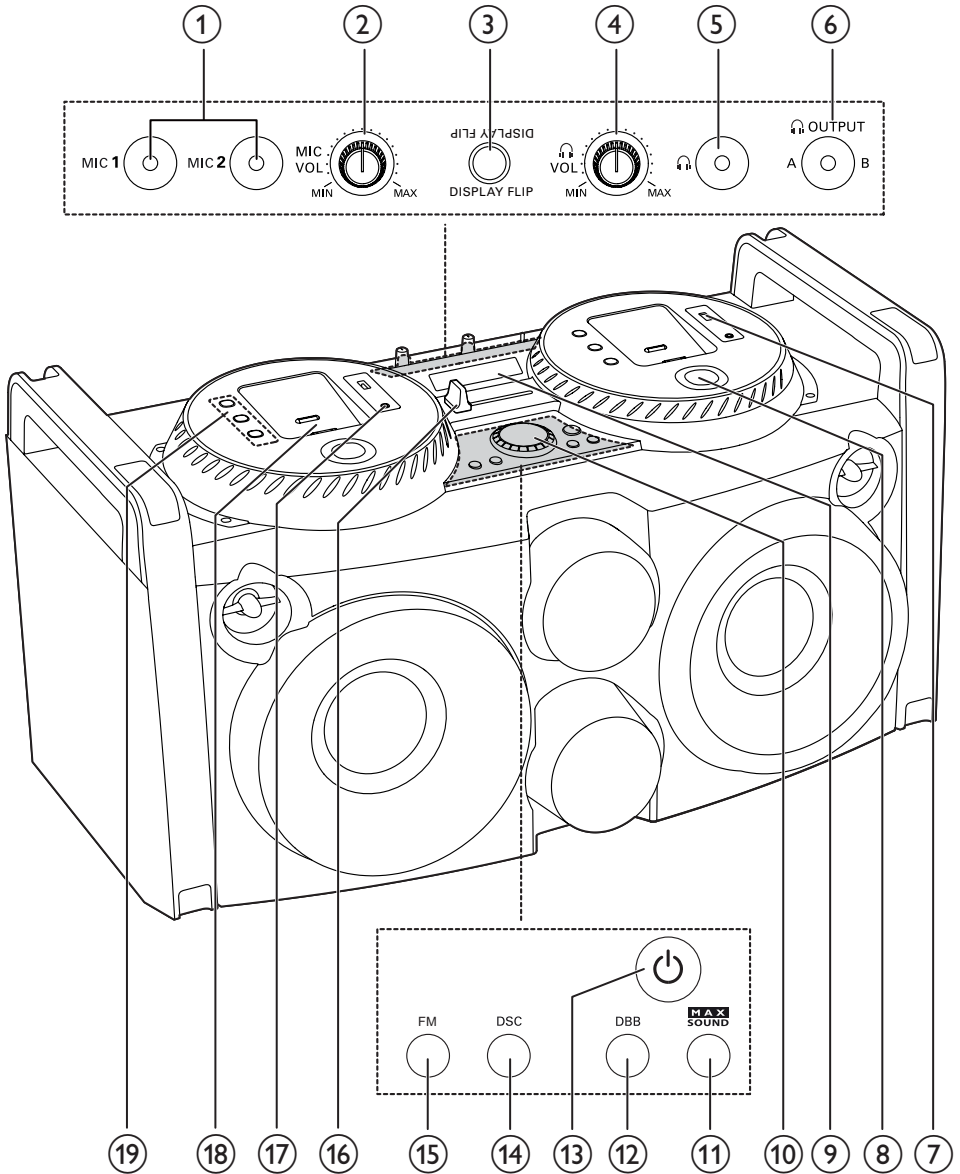

① MIC 1/MIC 2

- Connect microphones.

② MICVOL

- Adjust volume of the connected microphone(s).

- ③ **DISPLAY FLIP**
- Reverse the text displayed on the screen.
- ④ **VOL**
- Adjust headphone volume.
- ⑤ **Headphone icon**
- Connect a headphone for monitoring.
- ⑥ **OUTPUT A/B**
- Switch headphone output between audio source A and B.
- ⑦ **(A/B)**
- Connect a USB mass storage device.
- ⑧ **Play control keys**
- ⏪ / ⏩
- Skip to the previous/next track.
 - (Press and hold) tune to a radio station.

ALBUM/PRESET ▲ /TUNING ▼

- Select a preset radio station.
- During USB play, skip to the previous/next album.



- Start or pause play.

- ⑨ **Display panel**
- Show current status.

- ⑩ **Volume knob**
- Adjust speaker volume.

- ⑪ **MAX SOUND**
- Turn on/off instant power boost.

- ⑫ **DBB**
- Turn on/off dynamic bass enhancement.

- ⑬ **Standby icon**
- Turn on the unit or switch to standby mode.

- ⑭ **DSC**
- Select a preset sound setting.

- ⑮ **FM**
- Select the tuner source.

- ⑯ **CROSS FADER ASSIGN**
- swap play between audio source A and B.







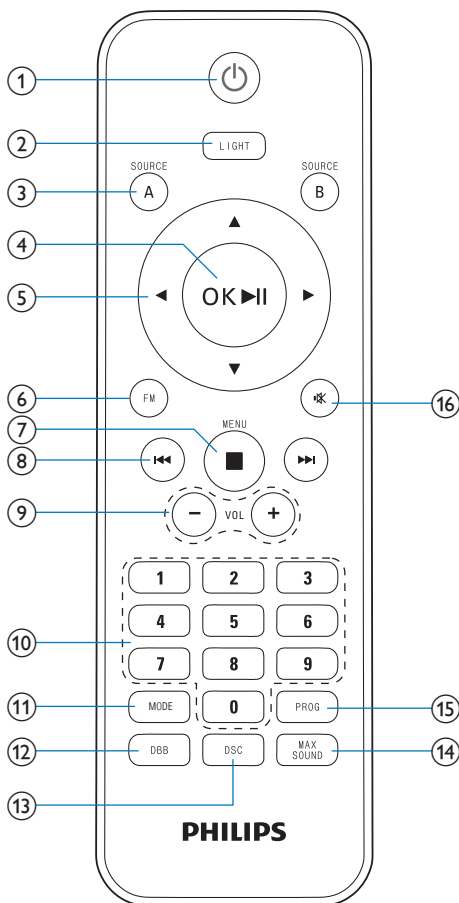

- ⑰ **MP3 LINK(A/B)**
- Connect an external audio device.

- ⑱ **Dock for iPod/iPhone(A/B)**

- ⑲ **Source selection keys (A/B)**
- Select a source: iPod/iPhone, USB or MP3 LINK.

Overview of the remote control



- ①  • Turn on the unit or switch to standby mode.
- ② **LIGHT**
- Adjust the decoration light around the speakers.
- ③ **SOURCE A/B**
- Select a source (A/B): iPod/Phone, USB or MP3-LINK.
- ④ **OK/ **
- Start or pause play.
 - confirm a selection.
 - In dock mode, navigate in the iPod/iPhone menu.
- ⑤ ****
- : in tuner mode, tune to a radio station.
 - : during USB play, skip to the previous/next album.
- ⑥ **FM**
- Select the tuner source.
- ⑦ **MENU/ **
- Stop play.
 - Access the iPod/iPhone menu.
 - Stop radio programming.
- ⑧ ****
- Skip to the previous/next track.
 - Search within a track.
 - Select a preset radio station.
- ⑨ **VOL +/-**
- Adjust speaker volume.
- ⑩ **Numeric keypad (0 to 9)**
- In USB mode, select a track directly.
 - In tuner mode, select a preset radio station directly.
- ⑪ **MODE**
- Select repeat/shuffle play modes.
- ⑫ **DBB**
- Turn on/off dynamic bass enhancement.
- ⑬ **DSC**
- Select a preset sound setting.
- ⑭ **MAX SOUND**
- Turn on/off instant power boost.
- ⑮ **PROG**
- Program radio stations.
- ⑯ ****
- Mute or restore sound output.

3 Get started

! Caution

- Use of controls or adjustments or performance of procedures other than herein may result in hazardous radiation exposure or other unsafe operation.

Always follow the instructions in this chapter in sequence.

If you contact Philips, you will be asked for the model and serial number of this apparatus. The model number and serial number are on the back of the apparatus. Write the numbers here:

Model No. _____

Serial No. _____

Prepare the remote control

- 1 Press and push the battery compartment to slide it open (see "1" in the illustration).
- 2 Insert two AAA batteries with correct polarity (+/-) as indicated.
- 3 Push and slide back the battery compartment (see "3" in the illustration).

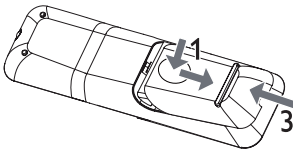

≡ Note

- The batteries shall not be exposed to excessive heat such as sunshine, fire or the like.
- If you are not going to use the remote control for a long time, remove the batteries.
- Do not mix batteries (old and new or carbon and alkaline, etc.).
- Batteries contain chemical substances, so they should be disposed of properly.

Connect power

! Caution

- Risk of product damage! Make sure that the power supply voltage corresponds to the voltage printed on the head of the AC power cord.
- Risk of electric shock! When you unplug the power cord, always pull the plug from the socket. Never pull the cord.

≡ Note

- Before you connect the AC power cord, make sure that you have completed all the other connections.

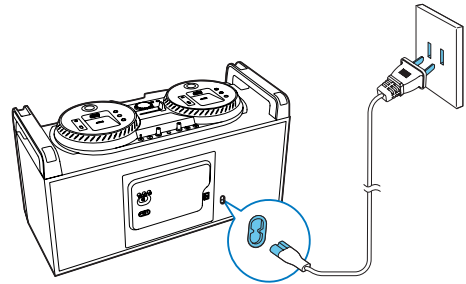

- Connect the AC power cord to
 - the ~ AC IN socket on this unit.
 - the wall power socket.

Turn on

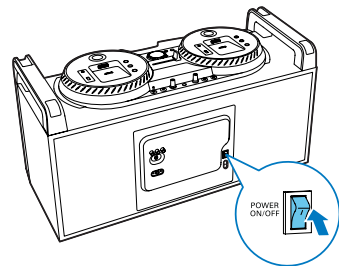

- 1 Turn the **POWER ON/OFF** switch on the back panel to the | position.
- 2 Press ϕ .
 - ↳ The unit switches to the last selected source.

Switch to standby mode

- Press ϕ to switch the unit to standby mode.
 - ↳ The backlight on the display panel turns off.

4 Play

Basic play operations

You can control play through the following operations.

Function	Action
To stop play	press MENU/ ■ .
To pause/ resume play	press ▶ .
To skip to a track	press ◀◀ / ▶▶ .
To search during play	press and hold ◀◀ / ▶▶ , then release to resume normal play.
To swap play between audio source A and B	<ul style="list-style-type: none"> • Press SOURCE A or SOURCE B repeatedly. • * On the top panel, move the channel fader to the left (A) or right (B) to fade in and fade out.

* When you use the channel fader to swap play between source A and B, the music play will not be interrupted. For example, when you move the channel fader from the left to the right, the song played from source A will gradually reduce to silence (fade-out), while at the same time, the song played from source B will gradually increase from silence (fade-in).

Play from iPod/iPhone

You can enjoy music from your iPod/iPhone through this unit.

With the dual docks, you can load two iPods/iPhones at the same time and swap play between them.

Compatible iPod/iPhone

The unit supports the following iPod/iPhone models.

Made for:

- iPod touch (1st, 2nd, 3rd, and 4th generation)
- iPod classic
- iPod nano (2nd, 3rd, 4th, 5th, and 6th generation)
- iPhone 4S
- iPhone 4
- iPhone 3GS
- iPhone 3G
- iPhone

Load the iPod/iPhone

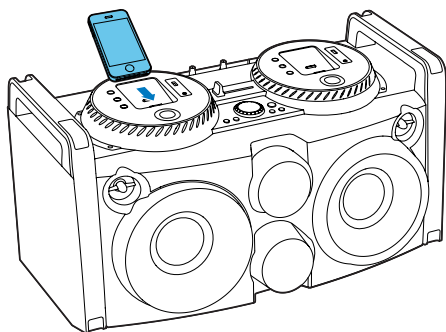

- 1 Insert your iPod/iPhone into the dock on either the left (A) or the right (B).
- 2 If needed, adjust the direction of the dock.

Remove the iPod/iPhone

- Pull the iPod/iPhone out of the dock.

Charge the iPod/iPhone

The dual docks allow you to load and charge two iPods/iPhones at the same time. When the unit is powered on, the docked iPod/iPhone begins to charge automatically.

Listen to the iPod/iPhone

Note

- Make sure that your iPod/iPhone has been loaded securely.

- 1 Depending on which source you want to listen to, press **SOURCE A** or **SOURCE B** repeatedly to select the iPod/iPhone source.
- 2 Start music play on your iPod/iPhone.
 - ↳ You can hear music from the Hi-Fi system.

Basic play operations

Besides the basic play operations, you can also control iPod/iPhone play through the following operations.

Function	Action
To access the iPod/iPhone menu	press MENU/■
To navigate up/down	press ▲▼ .
To navigate left/right	press ◀/▶ .
To pause or resume play	press OK/▶

Play from USB

Note



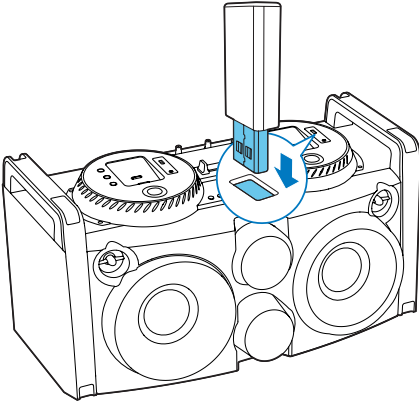

- Make sure that the USB device contains playable audio content.



- 1 Insert a USB mass storage device into the  socket on either the left (A) or the right (B).
- 2 Press **SOURCE** repeatedly to select the USB source.
↳ Play starts automatically.

Play options



Repeat and shuffle play

- Press **MODE** repeatedly to select:
 -  **-1** (repeat one): play the current track repeatedly.
 -  (repeat all): play all tracks repeatedly.
 -  (shuffle): play all tracks randomly.
 -  (repeat shuffle): play all tracks repeatedly in random order.
 - None: resume normal play.

Listen through headphone

Note

- When you listen and monitor through a headphone, the loudspeaker of the unit will be not muted.

- 1 Plug a headphone into the  socket on the top panel.
- 2 Depending on which audio source you want to listen to, switch  **OUTPUT** to the left (A) or right (B).
- 3 Use  **VOL** to adjust the monitor headphone volume.

5 Listen to radio

Tune to radio stations

Note

- To improve FM reception, fully extend and adjust the position of the FM antenna attached to the back panel.

- 1 Press **FM** to select the FM tuner source.
- 2 Press and hold **◀▶** for three seconds.
↳ The Hi-Fi system tunes to a station with strong reception automatically.

- 3 Repeat step 2 to tune to more stations.

To tune to a weak station:

- Press **◀▶** repeatedly until you find optimal reception.

Store radio stations

Note

- You can store a maximum of 20 FM radio stations.

- 1 Tune to a radio station.
- 2 Press **PROG** to activate programming.
- 3 Press **◀◀ / ▶▶** to allocate a number from 1 to 20 to this radio station, then press **PROG** to confirm.
↳ The preset number and the frequency of the preset station are displayed.
- 4 Repeat the previous steps to program other stations.

Note

- You can also use the numeric keypad directly to allocate a preset number. To allocate a 2-digit number, press the number corresponding to the first digit, and then press the number corresponding to the second digit within 2 seconds.
- To overwrite a programmed station, store another station in its place.

Select a preset radio station

- In tuner mode, press **◀◀ / ▶▶** repeatedly to select a preset radio station.

Tip

- You can also use the numeric keypad directly to select a preset number. To select a 2-digit number, press the number corresponding to the first digit, and then press the number corresponding to the second digit within 2 seconds.

6 Adjust sound

Adjust speaker volume

- During play, press **VOL +/-** to increase/decrease speaker volume.

Select a sound effect



Note

- You cannot use different sound effects at the same time.

Boost sound power

This feature allows you to give an instant boost to the sound power.

- Press **MAX SOUND** to turn on or off instant power boost.

Select a preset sound effect

The DSC (Digital Sound Control) feature allows you to enjoy special sound effects.

- During play, press **DSC** repeatedly to select:
 - **[SAMBA]** (samba)
 - **[ROCK]** (rock)
 - **[JUNGLE]** (jungle)
 - **[POP]** (pop)

Enhance bass

The best DBB (Dynamic Bass Enhancement) setting is generated automatically for each DSC selection. You can manually select the DBB setting that best suits your listening environment.

- During play, press **DBB** repeatedly to select:
 - DBB 1
 - DBB 2
 - DBB 3
 - DBB OFF

Mute sound

- During play, press **M** to mute or restore sound output.

Select an audio output mode

- Switch **CHANNEL CONTROL** at the back panel to one of the following positions:
 - **RR**: Audio output to the right channel only;
 - **RL**: Audio output to both the left and right channels;
 - **LL**: Audio output to the left channel only.

7 Additional features

Play audio from an external device

With this Hi-Fi system, you can play audio from an external audio device.

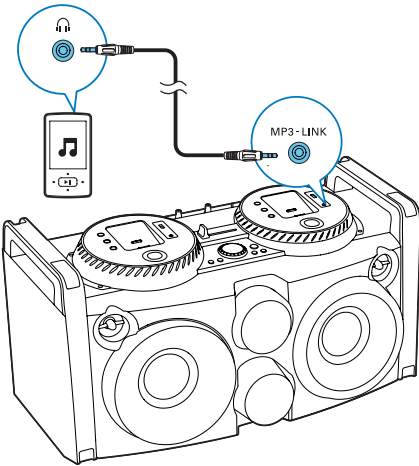

- 1 Connect the supplied MP3 Link cable to
 - the **MP3-LINK** socket on the left (A) or right (B) of the top panel
 - the headphone socket on an external device
- 2 Press **SOURCE A** or **SOURCE B** repeatedly to select the MP3 link source.
- 3 Play the external device (see the device's user manual).

Speak or sing through the Hi-Fi system

You can speak or sing through this Hi-Fi system with a microphone.

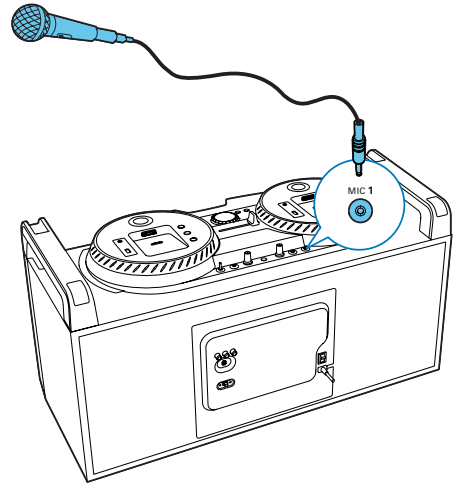

- 1 Connect a microphone (not supplied) to the **MIC 1** or **MIC 2** socket on the top panel.
- 2 Use the **MICVOL** knob on the top panel to adjust the microphone volume.

Enjoy simultaneous play

You can output audio to multiple compatible Hi-Fi systems (FWP1000) to enjoy simultaneous play.

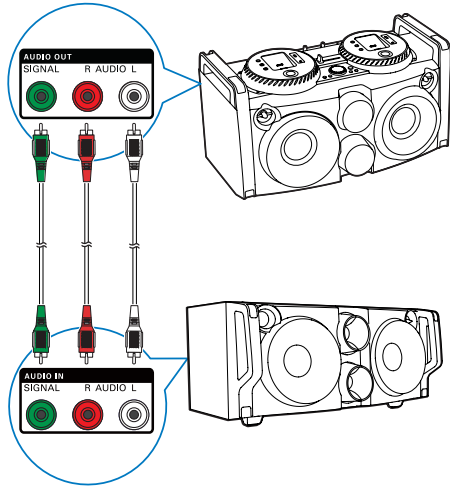

- 1 Connect audio cables (white/red) to:
 - the **AUDIO OUT (AUDIO L/R)** sockets on the back panel of this unit.
 - the **AUDIO IN (AUDIO L/R)** sockets on a compatible Hi-Fi system (FWP1000).
- 2 Connect a signal cable (green) to:
 - the **AUDIO OUT (SIGNAL)** socket on the back panel of the unit.
 - the **AUDIO IN (SIGNAL)** socket on a compatible Hi-Fi system (FWP1000).
- 3 If you like, connect more compatible Hi-Fi systems (FWP1000) together in the same way.
- 4 Start play on this unit (FWP3200D).
 - ↳ You can hear music from the loudspeakers of all the Hi-Fi systems connected to each other.

Adjust decoration light

- In power-on mode, press **LIGHT** repeatedly to adjust the decoration light around the loudspeakers.
 - Blue (default, blinking blue with the music beat)
 - Red (blinking red with the music beat)
 - Purple (blinking in different colors with the music beat)
 - Off

Tip

- The light blinks as the music beat changes.

8 Product information

Note

- Product information is subject to change without prior notice.

Specifications

Amplifier

Rated Output Power	300 W RMS Max Power
Frequency Response	35 Hz - 20 kHz, - 3 dB
Signal to Noise Ratio	> 70 dB

Tuner (FM)

Tuning Range	87.5 - 108 MHz
Tuning grid	50 KHz
Sensitivity - Mono, 50 dB S/N Ratio	18 - 22 dBf
Total Harmonic Distortion	> 2.0 %
Signal to Noise Ratio	> 50 dB

Speakers

Speaker Impedance	Treble: 6 ohm Bass: 4 ohm
-------------------	------------------------------

General information

AC power	110 - 240V ~, 50/60Hz
Operation power consumption	44 W
USB direct	Version 2.0/1.1
Dimensions (W x H x D)	704 x 385 x 364 mm
Weight	
- With Packing	17.53 kg
- Main Unit	14.49 kg

USB playability information

Compatible USB devices:

- USB flash memory (USB 2.0 or USB1.1)
- USB flash players (USB 2.0 or USB1.1)
- Memory cards (requires an additional card reader to work with this unit)

Supported formats:

- USB or memory file format FAT16, FAT32 (sector size: 512 bytes)
- MP3 bit rate (data rate): 32-320 Kbps and variable bit rate
- Directory nesting up to a maximum of 8 levels
- Number of albums/ folders: maximum 255
- Number of tracks/titles: maximum 999
- File name in Unicode UTF8 (maximum length: 128 bytes)

Unsupported formats:

- Empty albums: an empty album is an album that does not contain MP3/WMA files, and will not be shown in the display.
- Unsupported file formats are skipped. For example, Word documents (.doc) are ignored and not played.
- AAC, WAV, PCM audio files
- WMA files

9 Troubleshooting



Warning

- Never remove the casing of this apparatus.

To keep the warranty valid, never try to repair the system yourself.

If you encounter problems when using this apparatus, check the following points before requesting service. If the problem remains unsolved, go to the Philips web site (www.philips.com/welcome). When you contact Philips, ensure that the apparatus is nearby and the model number and serial number are available.

No power

- Make sure that the AC power plug of the unit is connected properly.
- Make sure that there is power at the AC outlet.
- Make sure that the **POWER ON/OFF** switch on the back panel is turned to the | position.
- To save power, the system switches off automatically after 30 minutes of inactivity (for example, in pause or stop mode).

No sound or poor sound

- Adjust the volume.
- The speaker may be mute. Press **MUTE** to restore sound output.

No response from the Hi-Fi system

- Disconnect and reconnect the AC power plug, then turn on the system again.
- As a power-saving feature, the unit switches off automatically 30 minutes after track play reaches the end and no control is operated.

Remote control does not work

- Before you press any function button, first select the correct source with the remote control instead of the main unit.
- Reduce the distance between the remote control and the unit.
- Insert the batteries with its polarities (+/- signs) aligned as indicated.
- Replace the batteries.
- Aim the remote control directly at the sensor on the front of the unit.

Poor radio reception

- Increase the distance between the unit and your TV or VCR.
- Fully extend the FM antenna.

USB device not supported

- The USB device is incompatible with the unit. Try another one.



2014 © WOOX Innovations Limited.

All rights reserved.

This product was brought to the market by WOOX Innovations Limited or one of its affiliates, further referred to in this document as WOOX Innovations, and is the manufacturer of the product. WOOX Innovations is the warrantor in relation to the product with which this booklet was packaged. Philips and the Philips Shield Emblem are registered trademarks of Koninklijke Philips N.V.

FWP3200D_93_UM_EN_V4.0

