

Register your product and get support at
www.philips.com/welcome

FWM9000



User manual

PHILIPS

Contents

1 Important	4
Safety	4
Notice	5

2 Your Mini Hi-Fi System	6
Introduction	6
What's in the box	6
Overview of the main unit	7
Overview of the remote control	9
Connect FM antenna	10
Connect AM antenna	10
Connect speakers	10
Connect speaker LEDs	11
Connect power	11

4 Get started	12
Prepare the remote control	12
Auto install radio stations	12
Set clock	12
Turn on	13

5 Play from a disc or USB	13
Play disc	13
Play from a USB device	14

6 Listen to an external device	14
Listen to an MP3 player	14
Listen to a PC	14
Listen to iPod/iPhone	15

7 Play options	15
Repeat and random play	15
Program tracks	15
Display play information	16

8 Adjust volume level and sound effect	16
Adjust volume level	16
Mute sound	16
Boost loudness	16
Select a preset sound effect	17
Enhance bass	17
Virtual surround	17
Customize sound for room acoustics	17

9 Listen to radio	18
Tune to a radio station	18
Program radio stations automatically	18
Program radio stations manually	18
Select a preset radio station	18

10 USB record	19
Record to a USB device	19
Schedule radio-to-USB record	19

11 Other features	20
Set the alarm timer	20
Select a preset radio station	21
Delete from a USB device	21
Copy files from USB 1 to USB 2	21
Karaoke	21

12 Product information	22
Specifications	22
USB playability information	23
Supported MP3 disc formats	23
Maintenance	23

13 Troubleshooting	24
---------------------------	----

1 Important

Safety



This 'bolt of lightning' indicates uninsulated material within your unit may cause an electrical shock. For the safety of everyone in your household, please do not remove product covering.

The 'exclamation point' calls attention to features for which you should read the enclosed literature closely to prevent operating and maintenance problems.

WARNING: To reduce the risk of fire or electric shock, this apparatus should not be exposed to rain or moisture and objects filled with liquids, such as vases, should not be placed on this apparatus.

CAUTION: To prevent electric shock, match wide blade of plug to wide slot, fully insert.

- ① Read these instructions.
- ② Keep these instructions.
- ③ Heed all warnings.
- ④ Follow all instructions.
- ⑤ Do not use this apparatus near water.
- ⑥ Clean only with dry cloth.
- ⑦ Do not block any ventilation openings. Install in accordance with the manufacturer's instructions.
- ⑧ Do not install near any heat sources such as radiators, heat registers, stoves, or other apparatus (including amplifiers) that produce heat.

- ⑨ Protect the power cord from being walked on or pinched, particularly at plugs, convenience receptacles, and the point where they exit from the apparatus.
- ⑩ Only use attachments/accessories specified by the manufacturer.
- ⑪ Use only with the cart, stand, tripod, bracket, or table specified by the manufacturer or sold with the apparatus. When a cart is used, use caution when moving the cart/apparatus combination to avoid injury from tip-over.



- ⑫ Unplug this apparatus during lightning storms or when unused for long periods of time.
- ⑬ Refer all servicing to qualified service personnel. Servicing is required when the apparatus has been damaged in any way, such as power-supply cord or plug is damaged, liquid has been spilled or objects have fallen into the apparatus, the apparatus has been exposed to rain or moisture, does not operate normally, or has been dropped.
- ⑭ Battery usage **CAUTION** – To prevent battery leakage which may result in bodily injury, property damage, or damage to the unit:
 - Install all batteries correctly, + and - as marked on the unit.
 - Do not mix batteries (old and new or carbon and alkaline, etc.).
 - Remove batteries when the unit is not used for a long time.
- ⑮ Apparatus shall not be exposed to dripping or splashing.

- ⑩ Do not place any sources of danger on the apparatus (e.g. liquid filled objects, lighted candles).
- ⑪ This product may contain lead and mercury. Disposal of these materials may be regulated due to environmental considerations. For disposal or recycling information, please contact your local authorities or the Electronic Industries Alliance: www.eiae.org.
- ⑫ Where the MAINS plug or an appliance coupler is used as the disconnect device, the disconnect device shall remain readily operable.



Warning

- Never remove the casing of this apparatus.
- Never lubricate any part of this apparatus.
- Never place this apparatus on other electrical equipment.
- Keep this apparatus away from direct sunlight, naked flames or heat.
- Never look into the laser beam inside this apparatus.
- Ensure that you always have easy access to the power cord, plug or adaptor to disconnect this apparatus from the power.



Caution

- Use of controls or adjustments or performance of procedures other than herein may result in hazardous radiation exposure or other unsafe operation.

Notice

Any changes or modifications made to this device that are not expressly approved by Philips Consumer Lifestyle may void the user's authority to operate the equipment.



Be responsible
Respect copyrights

The making of unauthorized copies of copy-protected material, including computer programs, files, broadcasts and sound recordings, may be an infringement of copyrights and constitute a criminal offence. This equipment should not be used for such purposes.

Environmental information

All unnecessary packaging has been omitted. We have tried to make the packaging easy to separate into three materials: cardboard (box), polystyrene foam (buffer) and polyethylene (bags, protective foam sheet.)

Your system consists of materials which can be recycled and reused if disassembled by a specialized company. Please observe the local regulations regarding the disposal of packaging materials, exhausted batteries and old equipment.

This apparatus includes this label:

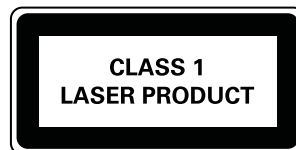

Note

- The type plate is located on the back of the unit.

2 Your Mini Hi-Fi System

Congratulations on your purchase, and welcome to Philips! To fully benefit from the support that Philips offers, register your product at www.Philips.com/welcome.

Introduction

With this unit, you can enjoy audio from discs, USB devices, iPod/iPhone, external devices, or radio stations.

For your convenience, you can load up to three discs at once.

To enrich sound, this unit offers you these sound effects:

- MAX sound for instant power boost
- Digital Sound Control (DSC)
- Dynamic Bass Boost (DBB)
- Incredible surround (IS)
- Virtual Ambience-based Control (VAC)

The unit supports the following media formats:



What's in the box

Check and identify the contents of your package:

- Main unit x 1
- Front speakers x 2
- Rear speakers x 2
- Subwoofer x 2
- Remote control with 2 AAA batteries
- FM wire antenna x 1
- AM loop antenna x 1
- MP3 link cable x 1
- Quick start guide x 1
- User manual x 1

Overview of the main unit

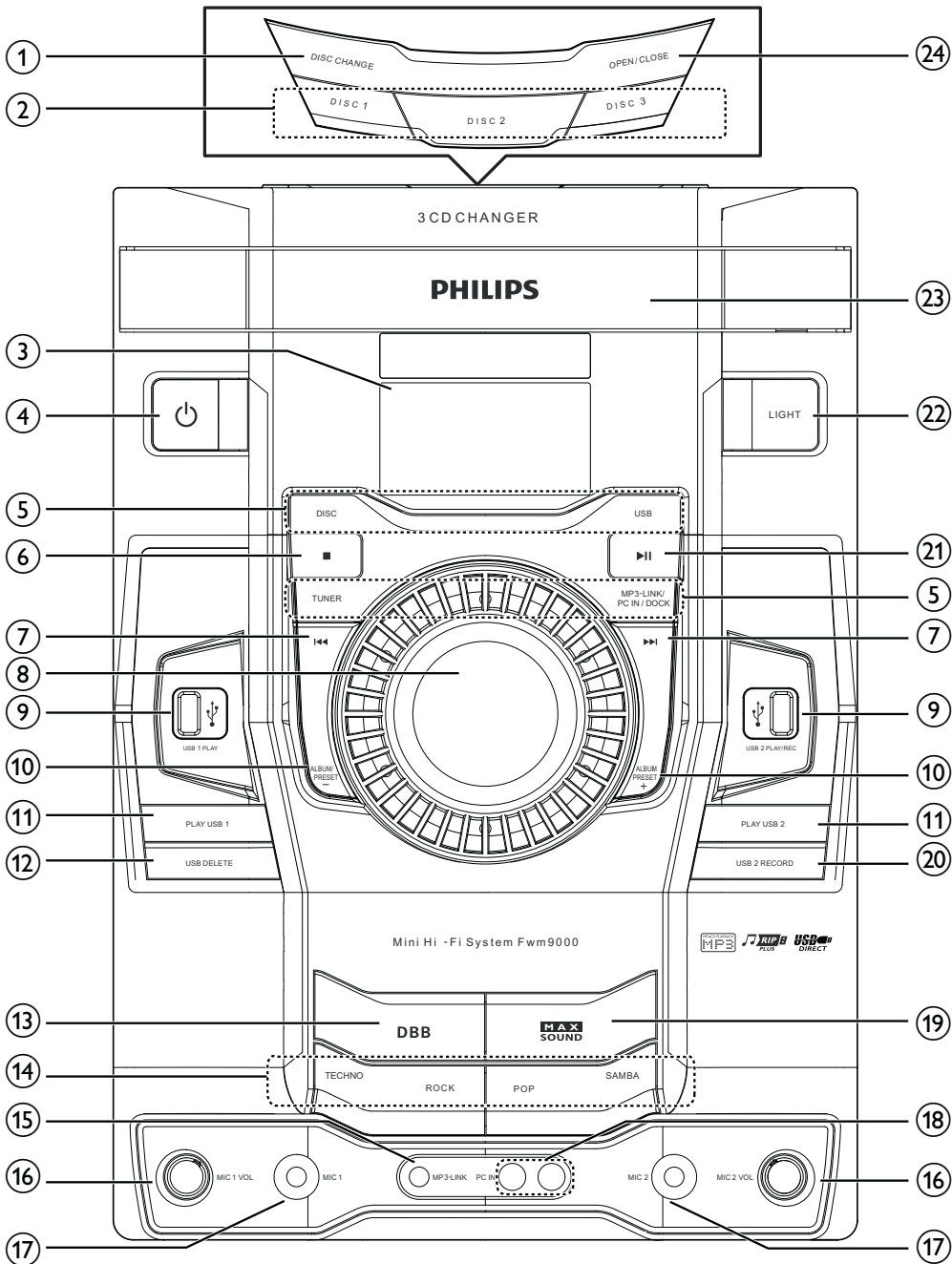

① **DISC CHANGE**
 • Change a disc.

② **DISC 1/2/3**
 • Select a disc.

③ **Display panel**
 • Show status.

④ **⏻**
 • Turn on the unit or switch to standby mode.

- ⑤ **Source selection keys**
 - Select a source.
- ⑥ **■**
 - Stop play or erase a program.
- ⑦ **⏮ / ⏭**
 - Skip to the previous/next track.
 - Search within a track/disc/USB/DOCK.
 - Tune to a radio station.
- ⑧ **VOLUME**
 - Adjust volume.
- ⑨ **🔌 USB 1 PLAY/USB 2 PLAY/REC**
 - Jack for a USB mass storage device.
 - Record to USB.
- ⑩ **ALBUM/PRESET +/-**
 - Skip to the previous/next album.
 - Select a preset radio station.
- ⑪ **PLAY USB 1/PLAY USB 2**
 - Play audio from USB source.
- ⑫ **USB DELETE**
 - Delete audio files stored on a USB device.
- ⑬ **DBB**
 - Turn on or off dynamic bass enhancement.
- ⑭ **DSC**
 - Select a preset sound equalizer setting.
- ⑮ **MP3 LINK**
 - Audio input jack (3.5mm) for an external audio device.
- ⑯ **MIC 1 VOL/MIC 2 VOL**
 - Adjust microphone volume.
- ⑰ **MIC 1/2 (Microphone port)**
 - Jack for a microphone.
- ⑱ **PC IN**
 - Connect to an external device.
- ⑲ **MAX SOUND**
 - Turn on or off instant power boost for sound.
- ⑳ **USB 2 RECORD**
 - Record to a USB device.
- ㉑ **▶||**
 - Start or pause play.
- ㉒ **LIGHT**
 - Turn on or off the lighting effect.
- ㉓ **Disc compartment door**
- ㉔ **OPEN/CLOSE**
 - Open or close the disc compartment.

Overview of the remote control

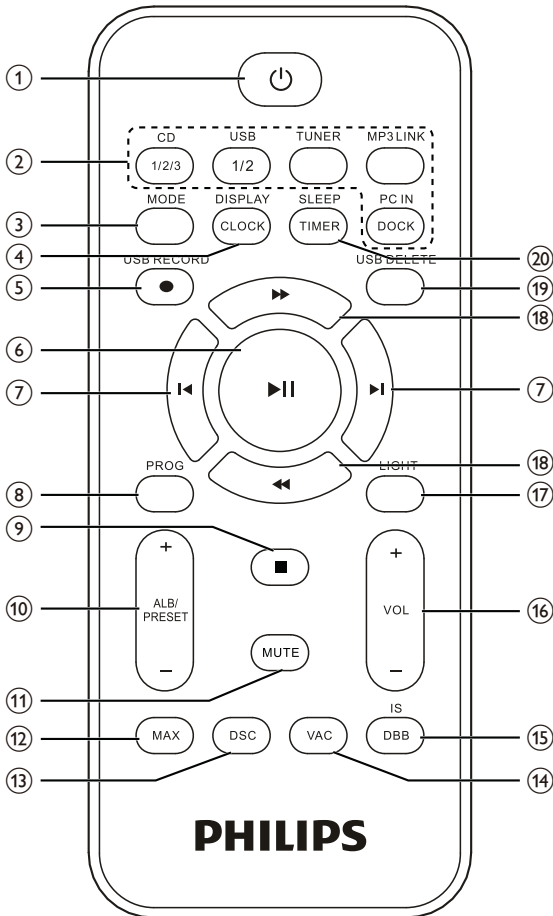

- ① **⏻**
 - Turn on the unit or switch to standby mode.
- ② **Source selection keys**
 - Select a source.
- ③ **MODE**
 - Select repeat play or random play.
- ④ **CLOCK/DISPLAY**
 - Select display information.
 - Set the clock/View the clock.
- ⑤ **USB RECORD**
 - Record to a USB device.

- ⑥ **▶||**
 - Start or pause play.
- ⑦ **◀/▶**
 - Skip to the previous/next track.
- ⑧ **PROG**
 - Program tracks.
 - Program radio stations.
- ⑨ **■**
 - Stop play or erase a program.
- ⑩ **ALB/PRESET+/-**
 - Skip to the previous/next album.
 - Select a preset radio station.
- ⑪ **MUTE**
 - Mute volume.
- ⑫ **MAX**
 - Turn on or off instant power boost for sound.
- ⑬ **DSC**
 - Select a preset sound equalizer setting.
- ⑭ **VAC**
 - Select an ambiance-based equalizer setting.
 - Turn on or off incredible surround.
- ⑮ **DBB/IS**
 - Turn on or off dynamic bass enhancement.
- ⑯ **VOL +/-**
 - Adjust volume.
- ⑰ **LIGHT**
 - Turn on or off the lighting effect. Turn on or off the lighting effect.
- ⑱ **◀◀/▶▶**
 - Search within a track/disc/USB/DOCK.
 - Tune to a radio station.
- ⑳ **USB DELETE**
 - Delete audio files stored on a USB device.
- ㉑ **SLEEP/TIMER**
 - Set the sleep timer.
 - Set the alarm timer.

3 Connect

Connect FM antenna

Connect the supplied FM antenna to the **FM** jack on the back of the main unit.

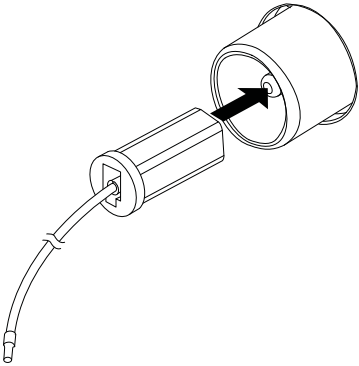

Connect AM antenna

1 Assemble the AM loop antenna.

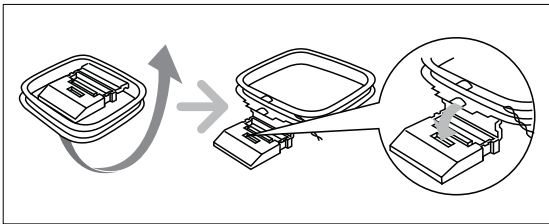

2 Connect the **AM** loop antenna to the **AM** jack on the back of the main unit.

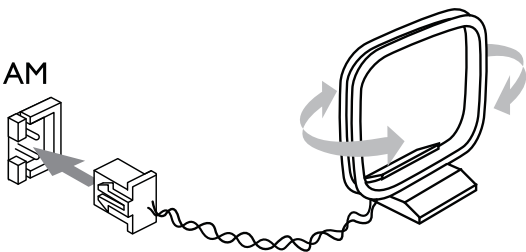

Connect speakers

Note

- For optimal sound, use the supplied speakers only.
- Connect only speakers with impedance that is the same or higher than the supplied speakers. Refer to the Specifications section of this manual.

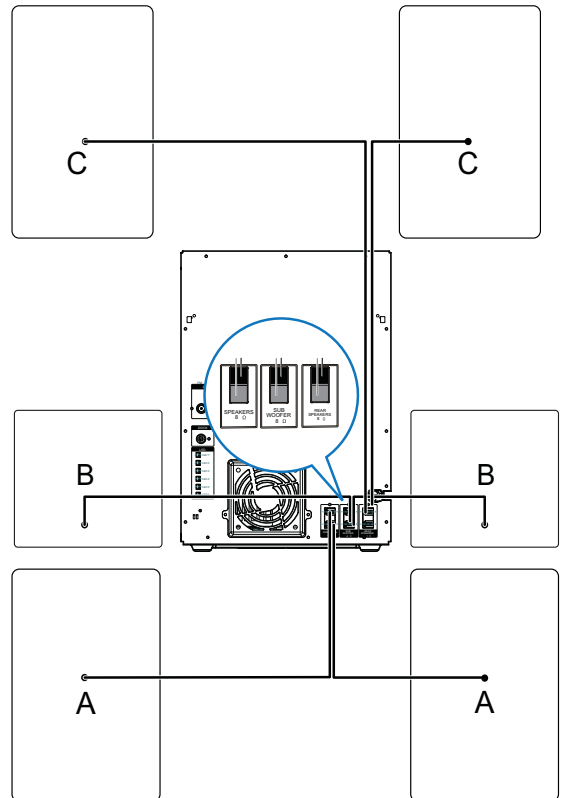

A: front speakers; **B:** rear speakers; **C:** subwoofers

Connect the front speakers

- 1 Find "**SPEAKERS**" sockets in black on the main unit.
- 2 Insert the connector of the front right speaker wire to "**R**", and the connector of the front left speaker wire to "**L**".

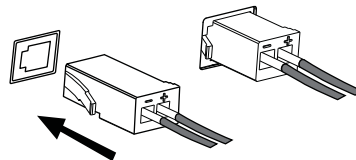

Connect the rear speakers

- 3 Find "REAR SPEAKERS" sockets in gray on the main unit.
- 4 Insert the connector of the rear right speaker wire to "R", and the connector of the rear left speaker wire to "L".

Connect the subwoofers

- 5 Find "SUB WOOFER" sockets in blue on the main unit.
- 6 Insert the connector of the right subwoofer to "R", and the connector of the left subwoofer wire to "L".

Connect speaker LEDs

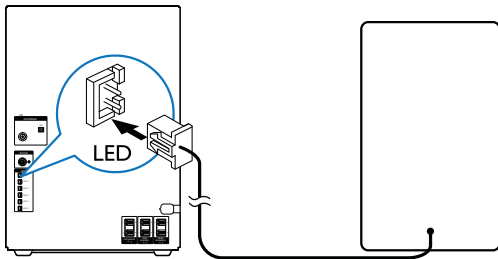

- 1 Find a LED socket on the back of the main unit.
- 2 Insert the connector of the LED wire to the LED socket.
- 3 Follow the steps above to connect the rest speaker LEDs.

Connect power



Caution

- Risk of product damage! Ensure that the power supply voltage corresponds to the voltage set on the voltage selector on the bottom of the unit.
- Ensure that the power supply socket used can support at least 10A current loading.
- Before connecting the AC power cord, ensure that you have completed all other connections.

- 1 If your power supply voltage is 110V-127V, adjust the voltage selector (locate on the bottom of the unit) to 110V-127V.
- 2 Connect the AC power cable to the wall socket.

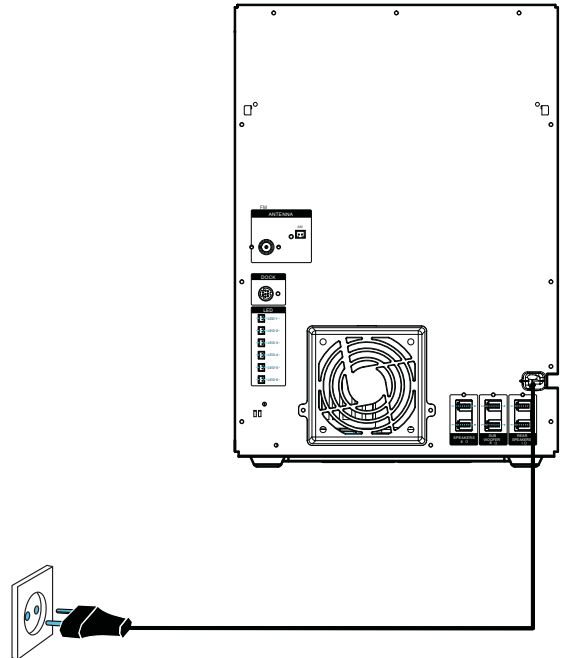

4 Get started

! Caution

- Use of controls or adjustments or performance of procedures other than herein may result in hazardous radiation exposure or other unsafe operation.

Always follow the instructions in this chapter in sequence.

If you contact Philips, you will be asked for the model and serial number of this apparatus. The model number and serial number are on the back of the apparatus. Write the numbers here:
Model No. _____
Serial No. _____

Prepare the remote control

≡ Note

- Risk of explosion! Keep batteries away from heat, sunshine or fire. Never discard batteries in fire.
- Danger of explosion if battery is incorrectly replaced. Replace only with the same or equivalent type.

To replace the remote control battery:

- 1 Open the battery compartment.
- 2 Insert two AAA batteries (not supplied) with correct polarity (+/-) as indicated.
- 3 Close the battery compartment.

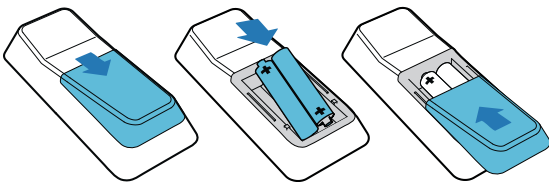

≡ Note

- If you are not going to use the remote control for a long time, remove the batteries.
- Do not use old and new or different types of batteries in combination.
- Batteries contain chemical substances, so they should be disposed of properly.

Auto install radio stations

When you connect power and no radio stations are stored, the unit automatically begins to store radio stations.

- 1 Connect the unit to the power supply.
↳ [AUTO INSTALL - PRESS PLAY] (auto install - press the PLAY button) is displayed.
- 2 Press ►|| on the main unit to start installation.
↳ [AUTO] (auto) is displayed.
↳ The unit automatically stores radio stations with sufficient signal strength.
↳ When all the available radio stations are stored, the first preset radio station is broadcast automatically.

Set clock

- 1 In the standby mode, press **CLOCK** to activate the clock setting mode.
↳ The 12 hour or 24 hour format is displayed.
- 2 Press **ALB/PRESET+/-** repeatedly to select 12 hour or 24 hour format.
- 3 Press **CLOCK** to confirm.
↳ The clock digits are displayed and begin to blink.
- 4 Press **ALB/PRESET+/-** to set the hour.
- 5 Press **◀/▶** to set the minute.
- 6 Press **CLOCK** to confirm.



Tip

- To view the clock during play, press **CLOCK**.

Turn on

Press **⏻**.

- ↳ The unit switches to the last selected source.

Switch to standby

Press **⏻** to switch the unit to standby mode.

- ↳ The backlight on the display panel turns off.
- ↳ The clock (if set) appears on the display panel.

5 Play from a disc or USB

Play disc

- 1 Press **CD 1/2/3** to select the disc source.
- 2 Press **OPEN/CLOSE** on the main unit to open the disc compartment.
- 3 Load up to two discs on the disc trays, with the printed side facing up.
 - To load the third disc, press **DISC CHANGE** on the main unit to rotate to the disc tray.

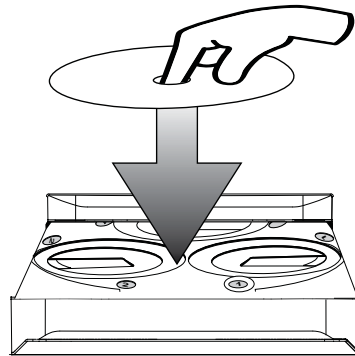

- 4 Press **OPEN/CLOSE** on the main unit to close the disc compartment.
 - ↳ Play starts automatically.
 - To select a disc, press **DISC 1/2/3**.
 - To pause/resume play, press **▶||**.
 - To stop play, press **■**.
 - To select another track, press **◀/▶**.
 - To select an album, press **ALBUM/PRESET+/-**.
 - To search within a track, press and hold **◀◀/▶▶**, and then release to resume normal play.

Play from a USB device

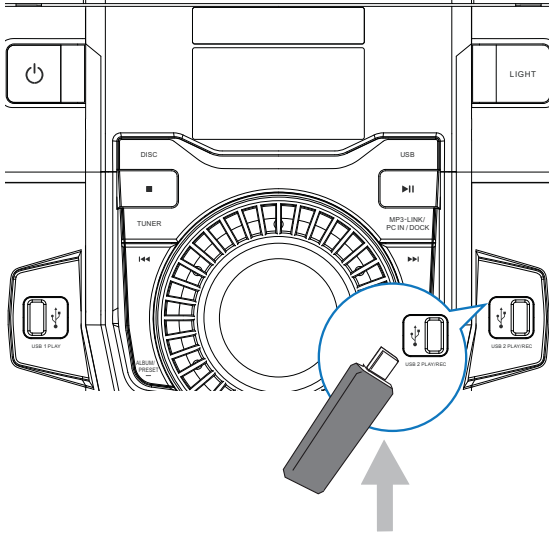

Note

- Ensure that the USB device contains playable audio contents for supported formats.

- 1 Insert the USB plug of the device into the **USB 1 PLAY** or **USB 2 PLAY/REC** socket.
- 2 Press **USB** to select the USB source.
- 3 Press **ALB/PRESET+/-** to select a folder.
- 4 Press **◀/▶** to select an audio file.
- 5 Press **▶||** to start play.
 - To pause/resume play, press **▶||**.
 - To stop play, press **■**.
 - To search within an audio file, press and hold **◀◀/▶▶**, then release to resume normal play.

6 Listen to an external device

You can listen to an external audio device through the speakers of this unit.

Listen to an MP3 player

- 1 Press **MP3 LINK** to select the MP3 source.
- 2 Connect the supplied MP3 link cable to:
 - the **MP3 LINK** jack (3.5mm) on the unit.
 - the headphone jack on the MP3 player.
- 3 Start to play the device (refer to the device user manual).

Listen to a PC

You can connect a PC or other audio devices.

- 1 Press **PC IN/DOCK** repeatedly to select the PC (Aux) source.
- 2 Connect the audio cables (white/red, not supplied) to:
 - the **PC IN** jacks (white/red) on the unit.
 - the headphone jack on the PC, or **AUDIO OUT** jacks on an external device.
- 3 Start to play the device (refer to the device user manual).

Listen to iPod/iPhone

- 1 Press **PC IN/DOCK** repeatedly to select the dock source.
- 2 Connect a Philips branded dock (modeled: DCK3060, sold separately) to the **DOCK** jack on the back of this unit.
 - Then dock your iPod or iPhone onto the dock.

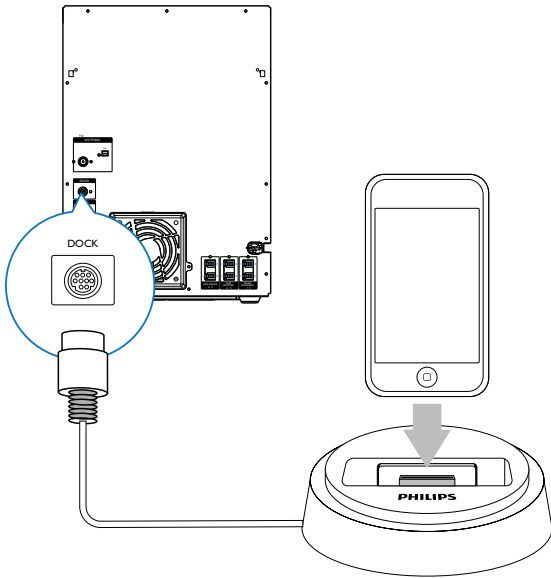

- 3 Start to play the device (refer to the iPod/iPhone user manual).

7 Play options

Repeat and random play

- 1 Press **MODE** repeatedly to select:
 - : the current track is played repeatedly.
 - : all tracks are played repeatedly.
 - : all tracks are played randomly and repeatedly.
 - : all tracks are played randomly.
- 2 To return to normal play, press **MODE** repeatedly until play mode is no longer displayed.



Tip

- Shuffle play cannot be selected when you play programmed tracks.

Program tracks

You can program a maximum of 40 tracks.

- 1 At CD/USB mode, in the stop position, press **PROG** to activate the program mode.
 - ↳ [PROG] (program) is displayed.
- 2 For MP3 tracks, press **ALBUM/PRESET+/-** to select an album.
- 3 Press **◀/▶** to select a track number; and then press **PROG** to confirm.
- 4 Repeat steps 2 and 3 to select and store all tracks to program.
- 5 Press **▶||** to play the programmed tracks.
 - ↳ During play, [PROG] (program) is displayed.
 - To erase the program, in the stop position, press **■**.

Display play information

During play, press **DISPLAY** repeatedly to select different play information.

8 Adjust volume level and sound effect



Note

- MAX sound and DSC (Digital Sound Control) cannot be activated at the same time.

Adjust volume level



Caution

- For your hearing health and being consideration of other people, it is not recommended to listen at high volume levels for a long time.

During play, press **VOL +/-** to increase/decrease the volume level.

Mute sound

During play, press **MUTE** to mute/unmute sound.

Boost loudness

MAX gives an instant boost to the sound power .

Press **MAX** to turn on or off the instant power boost.

- ↳ If MAX sound is activated, **MAX** is displayed.

Select a preset sound effect

The DSC (Digital Sound Control) enables you to enjoy special sound effects.

During play, press **DSC** repeatedly to select:

- [JAZZ] (jazz)
- [TECHNO] (techno)
- [ROCK] (rock)
- [POP] (pop)
- [SAMBA] (samba)

Customize sound for room acoustics

During play, press **VAC** repeatedly to select a type of listening environment:

- [HALL] (hall)
- [CONCERT] (concert)
- [CINEMA] (cinema)

Enhance bass

The best DBB (Dynamic Bass Enhancement) setting is generated automatically for each DSC selection. You can manually select the DBB setting that best suits your listening environment.

During play, press **DBB** repeatedly to select:

- DBB 1
- DBB 2
- DBB 3
- DBB off

↳ If DBB is activated, **DBB** is displayed.

Virtual surround

You can enhance audio with a virtual surround sound effect.

Press and hold **DBB/IS** to turn on or off the incredible surround.

↳ If the incredible surround is activated, [INC SURR] (incredible surround) is displayed.

9 Listen to radio

Tune to a radio station

- 1 Press **TUNER** repeatedly to select FM or AM.
- 2 Press and hold **◀◀ / ▶▶** for more than 2 seconds.
 - ↳ [SEARCH] (search) is displayed.
 - ↳ The radio tunes to a station with strong reception automatically.
- 3 Repeat step 2 to tune to more stations.
 - To tune to a weak station, press **◀◀ / ▶▶** repeatedly until you find optimal reception.

Program radio stations automatically

You can program a maximum of 40 preset radio stations.

In the tuner mode, press and hold **PROG** for more than 2 seconds to activate automatic program mode.

- ↳ [AUTO] (auto) is displayed.
- ↳ The unit automatically stores radio stations with sufficient signal strength.
- ↳ After all available radio stations are stored, the first stored radio station is broadcast automatically.

Program radio stations manually

You can program a maximum of 40 preset radio stations.

- 1 Tune to a radio station.
- 2 Press **PROG** to activate program mode.
 - ↳ [PROG] (program) blinks on the display.
- 3 Press **ALBUM/PRESET+/-** to allocate a number to this radio station, and then press **PROG** to confirm.
 - ↳ The preset number and the frequency of the preset station are displayed.
- 4 Repeat the previous steps to program other stations.



Tip

- To overwrite a programmed station, store another station in its place.

Select a preset radio station

In tuner mode, press **ALBUM/PRESET+/-** to select a preset number.



Tip

- Position the antenna as far as possible from TV, VCR, or other radiation source.
- For optimal reception, fully extend and adjust the position of the antenna.

10 USB record

Audio CD tracks, MP3 files, radio, and audio from external devices are recorded in .mp3 format, and WMA files are recorded in .wma format.

The first time you record to a USB device, a folder called 'PHILIPS' is automatically created in the USB device. Each time you record to a USB device, the recorded files are stored in a subfolder in the 'PHILIPS' folder. Files and subfolders are named numerically in the order in which they are created.

Note

- This function is only available for **USB 2 PLAY/REC** socket.

Record to a USB device

- 1 Connect a USB device to **USB 2 PLAY/REC** socket.
- 2 Prepare the source to record from.
 - Disc - Select the disc source and load a disc. You can select a track from which a recording starts.
 - Radio - Tune to a radio station.
 - MP3 LINK/ PC IN - Select the MP3 link/ PC IN source, and then connect and start to play an external device.
 - Karaoke - Singing during karaoke.
- 3 Press **USB RECORD** to start recording.
 - For discs, press **USB RECORD** repeatedly to select:
 - (A) [REC ONE] (record one): the first/ current track is recorded.
 - (B) [REC ALL] (record all): all tracks/the remaining tracks are recorded.
 - ↳ Disc play starts automatically from the beginning of the disc/the selected track, and the recording starts.
 - To stop recording, press **■**.

Note

- If the USB device does not have enough memory to store the audio files, a message about a full memory is displayed.

Schedule radio-to-USB record

Schedule radio recordings in advance and you can listen to your favorite programs at your convenience.



Note

- A recording is activated only in the standby mode.
- The maximum length of a recording is 12 hours.

- 1 Ensure that you set the clock correctly.
- 2 Plug a USB device to **USB 2 PLAY/REC** socket.
- 3 Tune to a radio station.
- 4 Press **⏻** to switch to standby mode.
- 5 Press and hold **TIMER** for more than 2 seconds.
 - ↳ A prompt to select the source is displayed.
- 6 Press **TUNER** repeatedly to select FM or AM.
- 7 Press **USB RECORD**.
 - ↳ The start timer digits are displayed and begin to blink.
- 8 Press **ALB/PRESET+/-** to set the hour.
- 9 Press **◀/▶** to set the minute.
- 10 Press **TIMER** to confirm.
 - ↳ The end timer digits are displayed and begin to blink.
- 11 Press **ALB/PRESET+/-** to set the hour.
- 12 Press **◀/▶** to set the minute.
- 13 Press **TIMER** to confirm.

- ↳  is displayed.
- ↳ At the scheduled times, the recording begins and ends automatically.
- ↳ When the recording ends, the unit switches to standby mode.

To deactivate or reactivate a record timer

- 1** In the standby mode, press **TIMER** repeatedly.
 - ↳ If the timer is activated,  is displayed.
 - ↳ If the timer is deactivated,  disappears.

11 Other features

Set the alarm timer



This unit can be used as an alarm clock. A disc, radio, or USB device is activated to play at a preset time.

Note

- If you have set a record timer and an alarm timer, only the latest timer is activated.

- 1** Ensure that you have set the clock correctly.
- 2** Press  to switch to standby mode.
- 3** Press and hold **TIMER** for more than 2 seconds.
 - ↳ A prompt to select the source is displayed.
- 4** Press **CD 1/2/3**, or **TUNER** or **USB 1/2** to select a source.
- 5** Press **TIMER** to confirm.
 - ↳ The clock digits are displayed and begin to blink.
- 6** Press **ALB/PRESET+/-** to set the hour.
- 7** Press **◀/▶** to set the minute.
- 8** Press **TIMER** to confirm.
 - ↳ The timer is set and activated.

To deactivate or reactivate an alarm timer

- 1** In the standby mode, press **TIMER** repeatedly.
 - ↳ If the timer is activated,  is displayed.
 - ↳ If the timer is deactivated,  disappears.

Tip

- In MP3 link or AUX mode, the alarm timer cannot be set.
- If a disc or USB source is selected but no audio file can be played, radio is activated automatically.

Select a preset radio station

In tuner mode, press **ALBUM/PRESET+/-** to select a preset number.



Tip

- Position the antenna as far as possible from TV, VCR, or other radiation source.
- For optimal reception, fully extend and adjust the position of the antenna.

Delete from a USB device

- 1 During play from a USB device, press **◀/▶** to select an audio file.
 - To delete an audio folder; in the stop position, press **ALB/PRESET+/-** to select an audio folder.
- 2 Press **USB DELETE**.
 - ↳ A confirmation message is displayed.
- 3 While the message is displayed, press **USB DELETE** again to confirm.
 - To cancel, press **■**.

Copy files from USB 1 to USB 2

You can copy MP3 / WMA files from USB 1 device to USB 2 device.

- 1 Connect both USB device to **USB 1 PLAY** and **USB 2 PLAY/REC** sockets.
- 2 Press **USB 1/2** to select the **USB 1 PLAY** source.
- 3 Select an audio file.
- 4 Press **USB RECORD** to start copy.
 - You can press **USB RECORD** repeatedly to select:
 - **[COPY ONE]** (copy one): the first/ current file is copied.

- **[COPY ALL]** (copy all): all files/the remaining files are copied.
- ↳ The track number and the percentage of copy progress are displayed.
- Press **■** to stop copy.

Karaoke

You can connect a microphone and sing along with a music source.

- 1 Turn **MIC VOL** to the minimum level.
- 2 Connect a microphone to the microphone port on the unit.
- 3 Press **CD 1/2/3**, or **TUNER**, or **USB**, or **MP3 LINK**, or **PC IN**, or **DOCK** to select the source, and start play.
- 4 Sing through the microphone.
 - To adjust the volume of the source, press **VOL +/-**.
 - To adjust the volume of the microphone, turn **MIC VOL**.

12 Product information

Note

- Product information is subject to change without prior notice.

Specifications

Amplifier

Total output power	1980W RMS
Frequency response	60 - 16kHz
Signal-to- noise ratio	>65 dBA
Aux In/Mp3 Link	1500mV/2000mV

Disc

Laser type	Semiconductor
Disc diameter	12cm/8cm
Support disc	CD-DA, CD-R, CD-RW, MP3-CD
Audio DAC	24Bits / 44.1kHz
Total harmonic distortion	<1%
Frequency response	60Hz -16kHz
S/N ratio	>70 dBA

Tuner

Tuning range	FM: 87.5 - 108MHz; AM: 531 - 1602kHz (9KHz); 530 - 1700KHz (10KHz)
Tuning grid	100KHz (FM); 9KHz/10KHz (AM)
Number of presets	40
FM	75ohm wire
AM	loop antenna

Speakers

Speaker Impedance	2 x 8 ohm
Woofers	2 x 8"
Tweeter	2 x 2"
Dimensions	258 x 452 x 388 mm
Weight	7 kg each

Rear speaker

Speaker Impedance	2 x 4 ohm
Dimension	267 x 198 x 375 mm
Wight	3.36 kg each

Subwoofer

Speaker impedance	2 x 8 ohm
Speaker driver	10"
Output power	2 x 400W RMS
Dimensions (W x H x D)	315 x 450 x 456 mm
Weight	10 kg

General information

AC power	110 - 127/220 - 240V, 50/60Hz
Operation power consumption	230 W
Standby power consumption	<15 W
USB direct	Version 2.0/1.1
Dimensions Main Unit (W x H x D)	265 x 430.5 x 377mm
Weight (without speakers)	6.85 kg

USB playability information

Compatible USB devices:

- USB flash memory (USB 2.0 or USB 1.1)
- USB flash players (USB 2.0 or USB 1.1)
- memory cards (requires an additional card reader to work with this unit)

Supported formats:

- USB or memory file format FAT12, FAT16, FAT32 (sector size: 512 bytes)
- MP3 bit rate (data rate): 32-320 Kbps and variable bit rate
- Directory nesting up to a maximum of 8 levels
- Number of albums/ folders: maximum 99
- Number of tracks/titles: maximum 999
- ID3 tag v2.0 or later
- File name in Unicode UTF8 (maximum length: 128 bytes)

Unsupported formats:

- Empty albums: an empty album is an album that does not contain MP3/WMA files, and is not be shown in the display.
- Unsupported file formats are skipped. For example, Word documents (.doc) or MP3 files with extension .dlf are ignored and not played.
- AAC, WAV, PCM audio files
- DRM protected WMA files (.wav, .m4a, .m4p, .mp4, .aac)
- WMA files in Lossless format

Supported MP3 disc formats

- ISO9660, Joliet
- Maximum title number: 999 (depending on file name length)
- Maximum album number: 99
- Supported sampling frequencies: 32 kHz, 44.1kHz, 48 kHz
- Supported Bit-rates: 32-320 (kbps), variable bit rates
- ID3 tag v2.0 or later
- Directory nesting up to a maximum of 8 levels

Maintenance

Clean the cabinet

- Use a soft cloth slightly moistened with a mild detergent solution. Do not use a solution containing alcohol, spirits, ammonia or abrasives.

Clean discs

- When a disc becomes dirty, clean it with a cleaning cloth. Wipe the disc from the centre out.

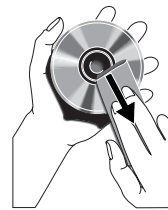

- Do not use solvents such as benzene, thinner, commercially available cleaners, or antistatic spray intended for analogue records.

Clean the disc lens

- After prolonged use, dirt or dust may accumulate at the disc lens. To ensure good play quality, clean the disc lens with Philips CD lens cleaner or any commercially available cleaner. Follow the instructions supplied with cleaner.

13 Troubleshooting



Warning

- Never remove the casing of this apparatus.

To keep the warranty valid, never try to repair the system yourself.

If you encounter problems when using this apparatus, check the following points before requesting service. If the problem remains unsolved, go to the Philips web site (www.philips.com/welcome). When you contact Philips, ensure that the apparatus is nearby and the model number and serial number are available.

No power

- Ensure that the AC power plug of the unit is connected properly.
- Ensure that there is power at the AC outlet.
- To save power, the unit switches to standby automatically 15 minutes after a play reaches the end and no control is operated.

No sound or poor sound

- Adjust the volume.
- Check that the speakers are connected correctly.
- Check if the stripped speaker wires are clamped.

Left and right sound outputs reversed

- Check the speaker connections and location.

No response from the unit

- Disconnect and reconnect the AC power plug, then turn on the unit again.

Remote control does not work

- Before you press any function button, first select the correct source with the remote control instead of the main unit.
- Reduce the distance between the remote control and the unit.

- Insert the batteries with their polarities (+/- signs) aligned as indicated.
- Replace the batteries.
- Aim the remote control directly at the sensor on the front of the main unit.

No disc detected

- Insert a disc.
- Check if the disc is inserted upside down.
- Wait until the moisture condensation at the lens has cleared.
- Replace or clean the disc.
- Use a finalized CD or correct format disc.

Cannot display some files in USB device

- The number of folders or files in the USB device has exceeded a certain limit. This phenomenon is not a malfunction.
- The formats of these files are not supported.

USB device not supported

- The USB device is incompatible with the unit. Try another one.

Poor radio reception

- Increase the distance between the unit and your TV or VCR.
- If the signal is too weak, adjust the antenna or connect an external antenna for better reception.

Clock/timer setting erased

- Power has been interrupted or the power cord has been disconnected.
- Reset the clock/timer.

Timer does not work

- Set the clock correctly.
- Switch on the timer.

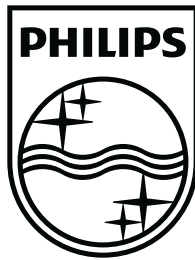

Specifications are subject to change without notice
© 2012 Koninklijke Philips Electronics N.V.
All rights reserved.

FWM9000_77_UM_V1.0

