

Always there to help you

Register your product and get support at
www.philips.com/support



AZ330T



User manual

PHILIPS

Contents

1	Important	2
	Safety	2
	Notice	3

2	Your CD Soundmachine	4
	Introduction	4
	What's in the box	4
	Overview of the main unit	5

3	Get started	7
	Connect power	7
	Turn on	8
	Turn off	8

4	Play	9
	Play a CD	9
	Play from USB devices	9
	Tune to FM radio stations	10
	Play from Bluetooth-enabled devices	10
	Play from an external device	11

5	Play options	12
	Control play	12
	Program tracks	12
	Adjust sound	12

6	Product information	13
	Specifications	13
	Supported MP3 disc formats	13
	USB playability informatio	14
	Maintenance	14

7	Troubleshooting	15
	About Bluetooth device	15

1 Important

Safety

- Read these instructions.
- Follow all instructions.
- Do not block any ventilation openings. Install in accordance with the manufacturer's instructions.
- Do not install near any heat sources such as radiators, heat registers, stoves, or other apparatus (including amplifiers) that produce heat.
- Protect the power cord from being walked on or pinched, particularly at plugs, convenience receptacles, and the point where they exit from the unit.
- Only use attachments/accessories specified by the manufacturer.
- Unplug this unit during lightning storms or when unused for long periods of time.
- Recording is permissible insofar as copyright or other rights of third parties are not infringed upon.
- Refer all servicing to qualified service personnel. Servicing is required when the unit has been damaged in any way, such as power-supply cord or plug is damaged, liquid has been spilled or objects have fallen into the apparatus, the unit has been exposed to rain or moisture, does not operate normally, or has been dropped.
- Battery usage CAUTION – To prevent battery leakage which may result in bodily injury, property damage, or damage to the unit:
 - Install all batteries correctly, + and - as marked on the unit.
 - Do not mix batteries (old and new or carbon and alkaline, etc.).
 - Remove batteries when the unit is not used for a long time.
- Batteries (battery pack or batteries installed) shall not be exposed to excessive heat such as sunshine, fire or the like.
- CAUTION: Danger of explosion if battery is incorrectly replaced. Replace only with the same or equivalent type.
- The unit shall not be exposed to dripping or splashing.
- Do not place any sources of danger on the unit (e.g. liquid filled objects, lighted candles).
- Where the MAINS plug or an appliance coupler is used as the disconnect device, the disconnect device shall remain readily operable.



Warning

- Never remove the casing of this apparatus.
- Never place this apparatus on other electrical equipment.
- Never look into the laser beam inside this apparatus.



Caution

- Use of controls or adjustments or performance of procedures other than herein may result in hazardous radiation exposure or other unsafe operation.

Notice

Any changes or modifications made to this device that are not expressly approved by WOOX Innovations may void the user's authority to operate the equipment.

Care of the environment

Disposal of your old product



Your product is designed and manufactured with high quality materials and components, which can be recycled and reused.

Do not throw away the product with the normal household waste at the end of its life, but hand it in at an official collection point or recycling. By doing this, you help to preserve the environment.

Environmental information

All unnecessary packaging has been omitted. We have tried to make the packaging easy to separate into three materials: cardboard (box), paper pulp (buffer) and polyethylene (bags, protective foam sheet.)

Your system consists of materials which can be recycled and reused if disassembled by a specialized company. Please observe the local regulations regarding the disposal of packaging materials, exhausted batteries and old equipment.

Trademark notice



Be responsible
Respect copyrights

The making of unauthorized copies of copy-protected material, including computer programs, files, broadcasts and sound recordings, may be an infringement of copyrights and constitute a criminal offence.

This equipment should not be used for such purposes.



The USB-IF Logos are trademarks of Universal Serial Bus Implementers Forum, Inc.

Bluetooth

The Bluetooth® word mark and logos are registered trademarks owned by Bluetooth SIG, Inc. and any use of such marks by WOOX Innovations is under license.

This apparatus includes these labels:



Class II equipment symbol



This symbol indicates that the apparatus has a double insulation system.



Note

- The type plate is located on the bottom of the apparatus.

2 Your CD Soundmachine

Introduction

With this CD Soundmachine, you can:

- Listen to FM radio;
- Enjoy audio from discs, USB device, Bluetooth devices, and other external audio devices;
- Program the play sequence of tracks.

What's in the box

Check and identify the contents of the package:

- Main unit
- Power cord
- Short User Manual

Overview of the main unit

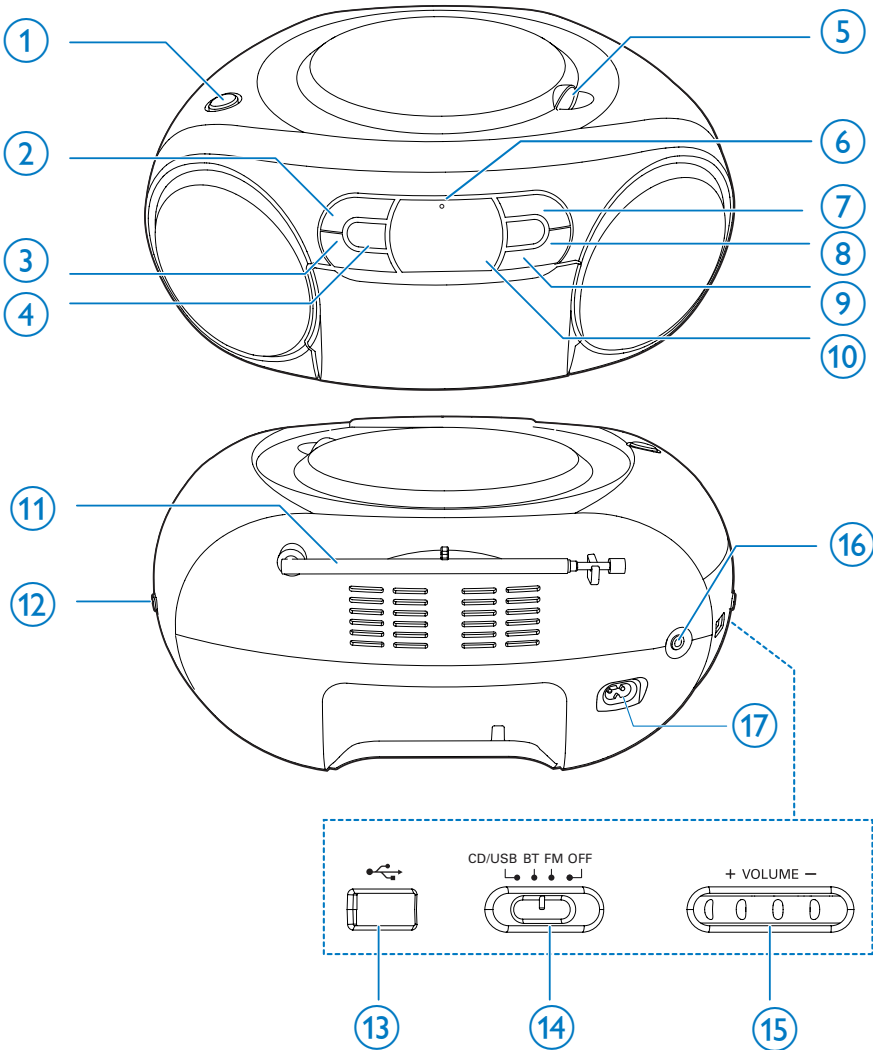

- ① **CD/USB source selector**
- Press to select CD or USB source.
- ② **■**
- Stop playing.
- ③ **- ALBUM +**
- Skip to the previous or next album.
- ④ **◀◀ / ▶▶**
- Skip to the previous or next track.
 - Search within a track.
- ⑤ **OPEN•CLOSE**
- Open or close the disc compartment.
- ⑥ **Bluetooth indicator**
- Indicate the status of Bluetooth connection.

- ⑦ **▶|||/PAIRING**
 - Start or pause play.
 - Press to wake up the unit from standby mode.
 - Press and hold to disconnect the connected Bluetooth device and enter pairing mode.
- ⑧ **PROG**
 - Program the play sequence of tracks.
- ⑨ **MODE**
 - Select a play mode.
- ⑩ **Display panel**
 - Display current status.
- ⑪ **FM antenna**
 - Improve FM reception.
- ⑫ **+ TUNING -**
 - Tune to FM radio stations.
- ⑬  **←**
 - USB socket.
- ⑭ **Source selector**
 - Select a source.
- ⑮ **+ VOLUME -**
 - Adjust volume.
- ⑯ **AUDIO-IN**
 - Connect an external audio device.
- ⑰ **AC MAINS**

3 Get started

! Caution

- Use of controls or adjustments or performance of procedures other than herein may result in hazardous radiation exposure or other unsafe operation.

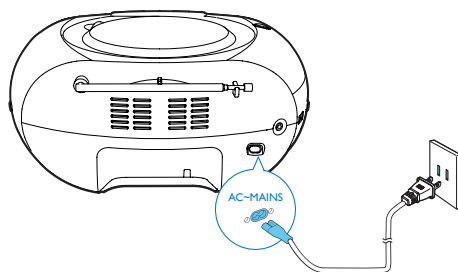

Always follow the instructions in this chapter in sequence.

If you contact Philips, you will be asked for the model and serial number of your apparatus. The model number and serial number are on the bottom of your apparatus. Write the numbers here:

Model No. _____

Serial No. _____

Connect power

The unit can be powered by either AC power or batteries.

Option 1: AC power

! Warning

- Risk of product damage! Make sure that the power supply voltage corresponds to the voltage printed on the back or the underside of the unit.
- Risk of electric shock! When you disconnect the AC power, always pull the plug from the socket. Never pull the cord.

Connect the AC power cord to the wall socket.

* Tip

- To save energy, turn the unit off after use.

Option 2: Battery power

! Caution

- Batteries contain chemical substances, so they should be disposed of properly.

☰ Note

- Batteries are not supplied with the accessories.

- 1 Open the battery compartment.
- 2 Insert 6 batteries (type: 1.5V R14/UM2/C CELL) with correct polarity (+/-) as indicated.
- 3 Close the battery compartment.

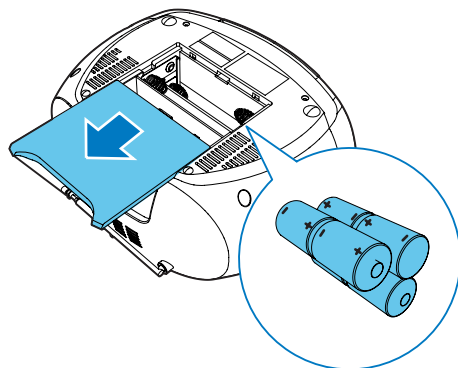

Turn on

Switch the source selector to **CD/USB/BT/FM**.

Switch to standby mode

- The product switches to standby mode automatically when there is no audio detected for over 15 minutes.
- Press **▶||** to wake up the product from standby mode.

Turn off

Switch the source selector on the product to **OFF**.

4 Play

Play a CD

Note

- You cannot play CDs encoded with copyright protection technologies.
- When an audio-in cable is plugged, CD/USB playback stops, and the unit switches to audio in mode automatically.

You can play commercially available audio CDs:

- CD-Recordables (CD-R)
- CD-Rewritables (CD-RW)
- MP3-CDs

- 1 Switch the source selector to **CD/USB**.
 - 2 Press the **CD/USB** button on the top of the CD sound machine repeatedly to select USB source.
↳ [**CD**] displays on the LCD screen.
 - 3 Open the CD compartment.
 - 4 Insert a CD with the printed side facing up and close the CD lid gently.
↳ Your CD sound machine starts to play automatically.
- To select a track, press **⏮ / ⏭**.
 - To pause CD play, press **⏸**.
↳ [**▶**] and track number flash.
 - To resume CD play, press **⏸** again.
 - To stop CD play, press **■**.

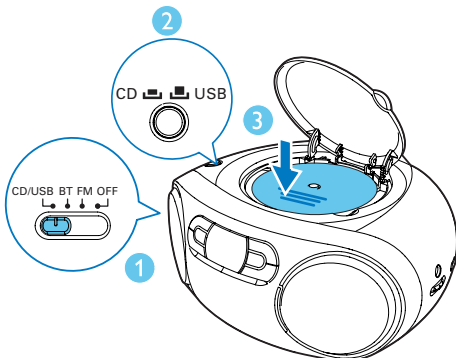

Play from USB devices

Note

- Make sure that the USB device contains playable audio content.

- 1 Switch the source selector to **CD/USB**.
- 2 Press the **CD/USB** button on the top of the CD sound machine repeatedly to select USB source.
↳ [**USB**] displays on the LCD screen.
- 3 Insert the USB device into the **↔** socket.
↳ Play starts automatically. If not, press **▶||**.

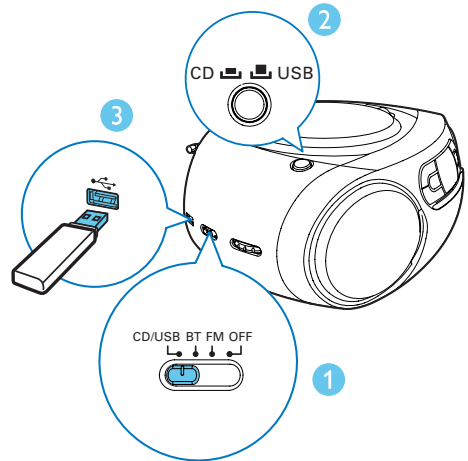

Tune to FM radio stations

Note

- For optimal reception, fully extend and adjust the position of the FM antenna.

- 1 Switch the source selector to **FM**.
- 2 Rotate **+TUNING -** to select a station.
- 3 Repeat step 2 to tune to more stations.

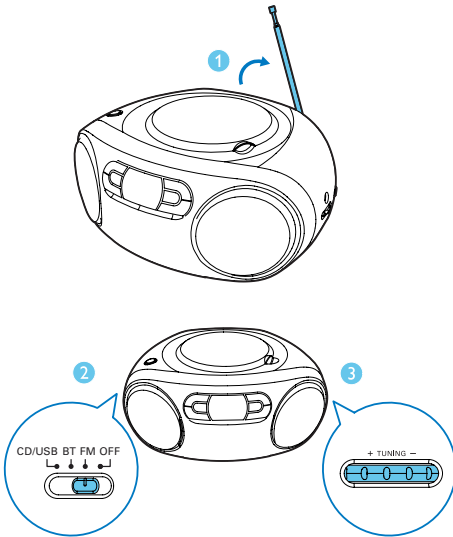

Play from Bluetooth-enabled devices

With this product, you can listen to audio from Bluetooth-enabled devices.

Connect a device

Note

- The operational range between this product and a Bluetooth device is approximately 10 meters (30 feet).

- 1 Switch the source selector to **BT**.
↳ The bluetooth indicator flashes blue.
- 2 On your Bluetooth device, enable Bluetooth and search for Bluetooth devices (refer to the user manual of the device).
- 3 Select **[Philips AZ330T]** on your device for pairing. If necessary, enter default password "0000".
↳ After successful pairing and connection, the product beeps twice, and the LED indicator turns solid blue.

Play from Bluetooth device

After successful Bluetooth connection, play audio on the Bluetooth device.

- ↳ Audio streams from your Bluetooth device to the product.

Disconnect the Bluetooth-enabled device

- Press and hold **PAIRING** for 2 seconds;
- Disable Bluetooth on your device; or
- Move the device beyond the communication range.

Connect another Bluetooth-enabled device

Disable Bluetooth on the current device, and then connect another device.

Play from an external device

You can also listen to an external audio device through this unit.

- 1 Switch the source selector to **CD/USB/BT/FM**.
- 2 Connect an audio cable (3.5mm, not supplied) to:
 - the **AUDIO-IN** socket on the unit.
 - the headphone socket on an external device.
- 3 Play the external device (see the device's user manual).

Note



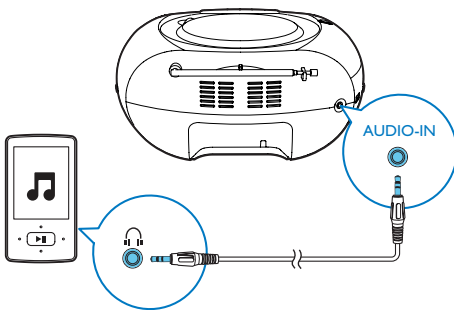



- The **AUDIO-IN** socket is not for headphones.
- In any working mode, the CD sound machine switches to AUDIO IN mode automatically when the audio-in cable is connected.
- The display panel lights off when the unit plays from the external device and "ÄU" displays on the screen.



5 Play options



Control play





In CD and USB mode, you can control play through the following operations.

	Press: skip to the previous/next track Hold: search within play, then release to resume play.
	Start or pause play.
	Stop play.
PROG	Program tracks.
+ VOLUME -	Adjust volume.
- ALBUM +	Skip the the previous or next album.
MODE	Select a play mode. []: Play the current track repeatedly. []: Play all tracks repeatedly. []: Repeat all tracks randomly. To return to normal play, press MODE repeatedly until the repeat icons disappear.



Tip

- Only [] and [] can be selected when you play the programmed tracks.

- 1 Press  to stop playback.
- 2 Press **PROG** to activate the program mode.
↳ [**PROG**] (program) begin to blink.
- 3 Press  /  to select a track number, then press **PROG** to confirm.
- 4 Repeat steps 3 to program more tracks.
- 5 Press  to play the programmed tracks.
↳ During play, [**PROG**] (program) is displayed.
 - To erase the program, press  twice.

Adjust sound

During play, you can adjust volume.

Key	Function
+ VOLUME -	Increase or decrease volume.

Program tracks

In CD and USB mode, you can program a maximum of 20 tracks.

6 Product information

Note

- Product information is subject to change without prior notice.

Specifications

Amplifier

Rated Output Power	2 x 2 W RMS
Frequency Response	125 -16000 Hz, -3dB
Signal to Noise Ratio	>57 dBA
Total Harmonic Distortion	<1 %
Audio-in Input	650 mV RMS

Disc

Laser Type	Semiconductor
Disc Diameter	12cm/8cm
Support Disc	CD-DA, CD-R, CD-RW, MP3-CD
Audio DAC	24Bits / 44.1kHz
Total Harmonic Distortion	<1%
Frequency Response	125 -16000 Hz, -3dB
S/N Ratio	>55 dBA

Tuner

Tuning Range	FM: 87.5 - 108MHz
Sensitivity:	
Mono, 26dB S/N Ratio	<22 dBf
Stereo, 46dB S/N Ratio	<43 dBf

Total Harmonic Distortion	<3%
Signal to Noise Ratio	>50 dBA

Bluetooth

Bluetooth Version	V3.0 + EDR
Range	10 m (Free space)
Bluetooth Frequency Band	2.402GHz ~ 2.48GHz

General

Power supply	110V~, 60 Hz;
- AC Power	DC 9V, 6 x 1.5 V type: R14/UM2/C CELL
- Battery	
Operation Power Consumption	15 W
Standby Power Consumption	<0.5 W
Dimensions	300 x 134 x 240 mm
- Main Unit (W x H x D)	
Weight (Main Unit)	1.4 kg

Supported MP3 disc formats

- ISO9660, Joliet
- Maximum title number: 512 (depending on file name length)
- Maximum album number: 255
- Supported sampling frequencies: 32 kHz, 44.1kHz, 48 kHz
- Supported Bit-rates: 32~256 (kbps), variable bit rates

USB playability informatio

Compatible USB devices:

- USB flash memory (USB 2.0 or USB1.1)
- USB flash players (USB 2.0 or USB1.1)
- memory cards (requires an additional card reader to work with this apparatus)

Supported formats:

- USB or memory file format FAT12, FAT16, FAT32 (sector size: 512 bytes)
- MP3 bit rate (data rate): 32-320 Kbps and variable bit rate
- Directory nesting up to a maximum of 8 levels
- Number of albums/ folders: maximum 99
- Number of tracks/titles: maximum 999
- ID3 tag v2.0 or later
- File name in Unicode UTF8 (maximum length: 128 bytes)

Unsupported formats:

- Empty albums: an empty album is an album that does not contain MP3/ WMA files, and is not be shown in the display.
- Unsupported file formats are skipped. For example, Word documents (.doc) or MP3 files with extension .dlf are ignored and not played.
- AAC, WAV, PCM, WMA audio files

Maintenance

Clean the cabinet

- Use a soft cloth slightly moistened with a mild detergent solution. Do not use a solution containing alcohol, spirits, ammonia or abrasives.

Clean discs

- When a disc becomes dirty, clean it with a cleaning cloth. Wipe the disc from the centre out.



- Do not use solvents such as benzene, thinner, commercially available cleaners, or antistatic spray intended for analogue records.

Clean the disc lens

- After prolonged use, dirt or dust may accumulate at the disc lens. To ensure good play quality, clean the disc lens with Philips CD lens cleaner or any commercially available cleaner. Follow the instructions supplied with cleaner.

7 Troubleshooting



Warning

- Never remove the casing of this device.

To keep the warranty valid, never try to repair the system yourself.

If you encounter problems when using this device, check the following points before requesting service. If the problem remains unsolved, go to the Philips Web page (www.philips.com/support). When you contact Philips, make sure that the device is nearby and the model number and serial number are available.

No power

- Ensure that the Mains cord is connected securely.
- Ensure that there is power at the AC Mains.
- Ensure that the batteries are inserted correctly.

No sound or poor sound

- Adjust the volume.

No response from the unit

- Disconnect and reconnect the AC power plug, then turn on the system again.
- As a power-saving feature, the unit switches off automatically 15 minutes after track play reaches the end and no control is operated.

No disc detected

- Insert a disc.
- Check if the disc is inserted upside down.
- Wait until the moisture condensation at the lens has cleared.
- Replace or clean the disc.
- Use a finalized CD or correct format disc.

Poor radio reception

- Increase the distance between the unit and your TV or VCR.
- Fully extend the FM antenna.

About Bluetooth device

The audio quality is poor after connection with a Bluetooth-enabled device.

- The Bluetooth reception is poor: Move the device closer to this product or remove any obstacle between them.

Cannot connect with the device.

- The Bluetooth function of the device is not enabled. Refer to the user manual of the device for how to enable the function.
- This product is already connected with another Bluetooth-enabled device. Disconnect that device and then try again.

The paired device connects and disconnects constantly.

- The Bluetooth reception is poor: Move the device closer to this product or remove any obstacle between them.
- For some devices, Bluetooth connection may be deactivated automatically as a power-saving feature. This does not indicate any malfunction of this product.



Specifications are subject to change without notice
2014 © WOOX Innovations Limited. All rights reserved.
Philips and the Philips' Shield Emblem are registered trademarks of
Koninklijke Philips N.V. and are used by
WOOX Innovations Limited under license from Koninklijke Philips N.V.

AZ330T_96_UM_V1.0

