

Portable DVD player

PET816

Register your product and get support at
www.philips.com/welcome

User manual



PHILIPS

1

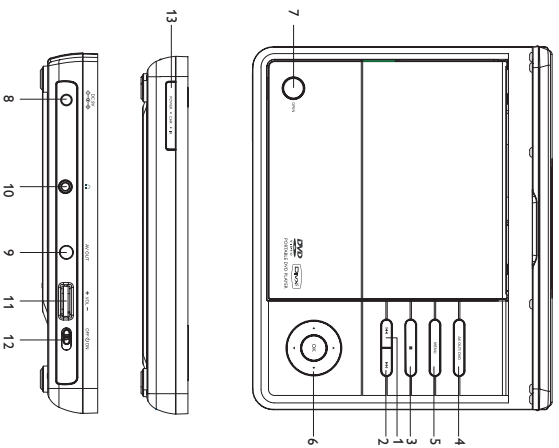

2

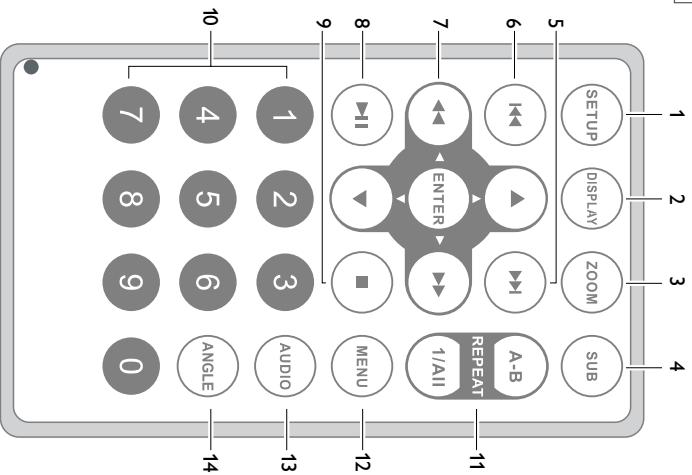

Congratulations on your purchase and welcome to Philips! To fully benefit from the support that Philips offers, register your product at www.philips.com/welcome.

Main unit controls (see figure 1)

- 1 **PREV**.....Skip to the previous chapter, track or title
- 2 **NEXT**.....Skip to the next chapter, track or title
- 3 **■**.....Stop playback
- 4 **AV OUT/DVD**.....Switch between DVD and AV OUT modes.
- 5 **MENU**.....Display the MENU page.
- 6 **▲, ▼, ◀, ▶**.....Navigate in a menu.
.....◀ / ▶ search backward/forward in a disc at different speeds.
- OK**.....Start or interrupt playback.
.....Confirm a selection.
- 7 **OPEN**.....Open the disc door to insert or remove disc

Left of player (see figure 1)

- 8 **DC 9V**.....Power supply socket.
- 9 **AV OUT**.....Audio/Video output jack.
- 10 **f**.....Headphone jack
- 11 **VOL +/-**.....Volume control.
- 12 **OFF** **ON**.....Switch the power on/off.

Front of player (see figure 1)

- 13 **POWER•CHG•IR**.....Power and charge indicator / Remote sensor

Remote controls (see figure 2)

- 1 **SETUP**.....Enter or exit the system menu.
- 2 **DISPLAY**.....Display information on TFT during playback.
- 3 **ZOOM**.....Enlarge or reduce a picture or active image on the TFT.
- 4 **SUB**.....Select a subtitle language.
- 5 **◀▶**.....Skip to the previous chapter, track or title.
- 6 **▶▶**.....Skip to the next chapter, track or title.
- 7 **▲, ▼, ◀, ▶**.....Navigate in a menu.
.....◀ / ▶ search backward/forward in a disc at different speeds.
- ENTER**.....Confirm a selection.
- 8 **▶||**.....Start or interrupt playback.
- 9 **■**.....Stop playback
- 10 **0-9**.....Numeric Keypad
- 11 **REPEAT 1/ALL**.....Repeat a chapter/track/title.
A-B.....Repeat playback of a specific section on a disc.
- 12 **MENU**.....Enter or exit the disc contents menu.
- 13 **AUDIO**.....Select an audio language when playing a DVD disc or select an audio mode (Stereo, Mono-Left or Mono-Right) when playing a VCD/CD disc.
- 14 **ANGLE**.....Select DVD camera angle

CAUTION

Use of controls or adjustments or performance of procedures other than herein may result in hazardous radiation exposure or other unsafe operation.

INTRODUCTION

Your portable DVD player

Your portable DVD player plays digital video discs conforming to the universal DVD Video standard. With it, you will be able to enjoy full-length movies with true cinema picture quality, and stereo or multichannel sound (depending on the disc and on your playback set-up).

The unique features of DVD-Video, such as selection of soundtrack and subtitle languages, and of different camera angles (again depending on the disc), are all included.

What's more, parental lock lets you decide which discs your children will be able to see. You will find your player remarkably easy to use with the On-Screen Display and player display in combination with the remote control.

Unpacking

First check and identify the contents of your package, as listed below:

- Portable DVD player
- Car adaptor (12V)
- User Manual
- AC power adaptor, DSA-9W-09 F (DVE)
- Remote Control
- Audio / Video cable
- Warranty

Placement

- Place the player on a firm, flat surface.
- Keep away from domestic heating equipment and direct sunlight.
- If the player cannot read CDs/DVDs correctly, try using a commonly available cleaning CD/DVD to clean the lens before taking the player to be repaired. Other cleaning methods may destroy the lens.
- Always keep the disc door closed to avoid dust on the lens.
- The lens may cloud over when the player is suddenly moved from cold to warm surroundings. It is then not possible to play a CD/DVD. Leave the player in a warm environment until the moisture evaporates.

INTRODUCTION

About Built-in Rechargeable Battery**Precautions related to battery recharge**

- 1 Once the battery is fully discharged, immediately recharge it (regardless of whether you plan to use the battery or not) in order to maximize the battery life. When the power is low, the battery icon will be shown on the upper-left corner of the TFT for warning.
- 2 To charge the battery, please directly connect this DVD player to AC mains and the charge indicator will turn on.

Using and maintaining your rechargeable batteries

- 1 Please make sure you always use only the AC adaptor included with the player to recharge your batteries.
- 2 Recharge efficiency will degrade when the environmental temperature drops below 50°F (10°C) or exceed 95°F (35°C).
- 3 The lasting time of the fully charged battery when a headphone is connected to the DVD player is approximately 2 hours.

Playable disc formats

In addition to DVD-Video disc, you will also be able to play all Video CDs and audio CDs (including CD±R, CD±RW, DVD±R and DVD±RW).

DVD-Video

Depending on the material on the disc (a movie, video clips, a drama series, etc.), these discs may have one or more Titles, and each Title may have one or more Chapters. To make access easy and convenient, your player lets you move between Titles, and also between Chapters.

CD with JPEG files

You can also view JPEG still photos on this player.



Video CD

Depending on the material on the disc (a movie, video clips, a drama series, etc.) these discs may have one or more Tracks, and tracks may have one or more indexes, as indicated on the disc case. To make access easy and convenient, your player lets you move between tracks and between indexes.

Audio CD / MP3 CD

Audio CDs / MP3-CD contain music tracks only. You can play them in the conventional way through a stereo system using the keys on the remote control and/or main unit, or via the TV using the On Screen Display (OSD).

About DivX

DivX is a popular media technology created by DivX, Inc. DivX media files contain highly compressed video with high visual quality that maintains a relatively small file size. DivX files can also include advanced media features like menus, subtitles, and alternate audio tracks. Many DivX media files are available for download online, and you can create your own using your personal content and easy-to-use tools from www.DivX.com.



Power Sources

- This unit operates on a supplied AC adaptor and car adaptor.
- Make sure that the input voltage of the AC adaptor is in line with the local voltage. Otherwise, the AC adaptor and unit may be damaged.
 - Do not touch the AC adaptor with wet hands to prevent electric shock.
 - When connecting with car power (cigarette lighter) adaptor, be sure the input voltage of the adaptor is identical with car voltage.
 - Unplug the AC adaptor from the outlet when the unit is not used for long periods of time.
 - Hold the plug to disconnect the AC adaptor. Do not pull the power cord.

Safety and maintenance

- Do not disassemble the unit for laser rays are dangerous to eyes. Any service should be done by qualified service personnel.
 - Unplug the AC adaptor to cut the power if liquid or objects get inside the unit.
 - Take care not to drop the unit or subject it to strong shocks, which may cause malfunction.
 - Important (for models with by-packed headphones): Schneider guarantees compliance with the maximum sound power of its audio players as determined by relevant regulatory bodies only with the original model of provided headphones. In case this one needs replacement, we recommend that you contact your retailer to order a model identical to that of the original provided by Philips.
 - Traffic safety: do not use while driving or cycling as you may cause an accident
 - Do not expose to excessive heat caused by heating equipment or direct sunlight.
 - This product is not waterproof; do not allow your player to be submerged in water. Water entering the player may cause major damage.
 - Do not use any cleaning agents containing alcohol, ammonia, benzene, or abrasives as these may harm the player.
 - Apparatus shall not be exposed to dripping or splashing. Do not place any sources of danger on the apparatus (e.g. liquid filled objects, lit/candled candles)
 - Do not touch the lens!
 - Excessive sound pressure from earphones and headphones can cause hearing loss.
 - Battery shall not be exposed to excessive heat such as sunshine, fire or the like.
- Note: When the player is in use for a long period of time, the surface will be heated. This is normal.*

GENERAL INFORMATION

Hearing Safety

Listen at a moderate volume:

- Using headphones at a high volume can impair your hearing. This product can produce sounds in decibel ranges that may cause hearing loss for a normal person, even for exposure less than a minute. The higher decibel ranges are offered for those that may have already experienced some hearing loss.
- Sound can be deceiving. Over time your hearing "comfort level" adapts to higher volumes of sound. So after prolonged listening, what sounds "normal" can actually be loud and harmful to your hearing. To guard against this, set your volume to a safe level before your hearing adapts and leave it there.

**To establish a safe volume level:**

- Set your volume control at a low setting.
- Slowly increase the sound until you can hear it comfortably and clearly, without distortion.

Listen for reasonable periods of time:

- Prolonged exposure to sound, even at normally "safe" levels, can also cause hearing loss.
- Be sure to use your equipment reasonably and take appropriate breaks.

Be sure to observe the following guidelines when using your headphones:

- Listen at reasonable volumes for reasonable periods of time.
- Be careful not to adjust the volume as your hearing adapts.
- Do not turn up the volume so high that you can't hear what's around you.
- You should use caution or temporarily discontinue use in potentially hazardous situations.
- Do not use headphones while operating a motorized vehicle, cycling, skateboarding, etc.; it may create a traffic hazard and is illegal in many areas.

GENERAL INFORMATION

Handling discs

- Do not attach paper or tape to the disc.
- Keep the disc away from direct sunlight or heat sources.
- Store the disc in a disc case after playback.
- To clean, wipe the disc outwards from the center with a soft, lint-free clean cloth.

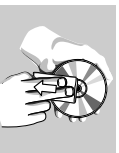
**On handling the LCD screen**

The LCD is manufactured using high precision technology. You may, however, see tiny black points and/or bright points (red, blue green) that continuously appear on the LCD. This is a normal result of the manufacturing process and does not indicate a malfunction.

Environmental information

We have reduced the packaging to its minimum and made it easy to separate into mono materials: cardboard, PS, PE and PET. Your set consists of material which can be recycled if disassembled by a specialized company. Please observe the local regulations to dispose of packaging, exhausted batteries and old equipment.

Copyright information

"DivX, DivX" Certified, and associated logos are trademarks of DivX, Inc. and are used under license."

All other brand and product names are trademarks of their respective companies or organizations.

Unauthorized duplication of any recordings downloaded from the internet or made from CDs / VCDs / DVDs is a violation of copyright laws and international treaties.

Power supply

Using the AC / DC adaptor

Turn off the player before connecting the supplied adaptor to it and the main power supply (as shown). The player must be turned off when the battery charges.



TIP

To avoid damage to the player, switch off before plugging or unplugging the AC adaptor.

Using the car adaptor

Connect the supplied car adaptor to the set and the car cigarette lighter outlet.

TIP

- To avoid damage to the player, switch off before plugging or unplugging the car adaptor.
- When connecting with car power (cigarette lighter) adaptor, be sure the input voltage of the adaptor is identical with car voltage.
- Make sure the temperature is below 35°C when the DVD player is connected to DC 16.0V in a car.

Powering your remote control

- 1 Open the battery compartment. Remove the protective plastic tab (first time users only).
- 2 Insert 1 x lithium 3V battery, type CR2025, then close the compartment.



CAUTION

- Batteries contain chemical substances, so they should be disposed of properly.
- Danger of explosion if battery is incorrectly replaced. Replace only with the same or equivalent type.
- Incorrect use of batteries can cause electrolyte leakage and will corrode the compartment or cause the batteries to burst.

Remove the battery if the remote control is not to be used for a long time.

Connections

Connecting headphones

Connect the headphones into the ϕ jack of your set.



Connecting additional equipment

- Turn off your set before connecting to any additional equipment.
- You can connect the player to a TV or an amplifier to enjoy DVDs or karaoke.

AV OUT

Connect the desired device to this terminal directly (no setting needed in the DVD model).

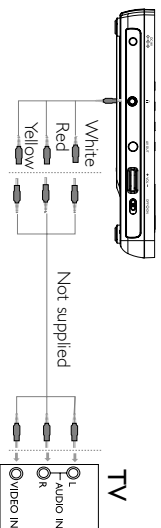

GENERAL EXPLANATION

About this manual

This manual gives the basic instructions for operating this DVD player. Some DVD discs however are produced in a way that requires specific operation or allows only limited operation during playback. In these cases the player may not respond to all operating commands. When this occurs, please refer to the instructions in the disc inlay. When a "⊗" appears on the screen, the operation is not permitted by the player or the disc.

Remote control operation

- Unless otherwise stated, all operations can be carried out with the remote control. Always point the remote control directly at the player, making sure there are no obstructions in the path of the infrared beam.
- When there are corresponding keys on the main unit, they can also be used.

Menu navigation

- Your player has an intuitive menu navigation system to guide you through various settings and operations.
- Use the function keys to activate / disable relevant operations.
- Use **▲**, **▼**, **▶**, **◀** to browse through menus.
- Press **ENTER** key to confirm your selection.

BASIC FUNCTIONS

Switching on for OSD language setup

English is the default language of your player's on screen display. You may choose to use English, French, or German for your player's on screen display.

Region _____ OSD Language Options

Asia Pacific _____ English, French, German

- 1 Slide the **POWER** switch to **ON** to switch on the player.
- 2 Press **SETUP** for the setup menu.
- 3 Select **General Setup Page** and press **ENTER**.
- 4 Scroll and select **OSD Language** and press **▶** to select from OSD language options.
- 5 Select your preferred language and press **ENTER**.



Loading discs and switching on

- 1 Slide **OPEN** to open the disc door.
- 2 Insert your chosen disc, label side up (also when a double sided DVD disc is inserted). Make sure it is sitting properly in the correct recess.
- 3 Gently push to close the door.
- 4 Slide the **POWER** switch to **ON** to switch on the player.



TPP

A normal mechanical noise is heard during playback.

Playing a DVD disc

After switching on, inserting the disc and closing the door, playback starts automatically. The screen shows the type of disc loaded. The disc may invite you to select an item from a menu. Use the ▲, ▼, ◀, ▶ keys to highlight your selection, and press **ENTER**.

Note: Since it is usual for DVD movies to be released at different times in different regions of the world, all players have region codes and discs can have an optional region code. If you load a disc of a different region code to your player, you will see the region code notice on the screen. The disc will not play, and should be unloaded.

Playing an audio or video CD disc

- After switching on, inserting the disc and closing the door, playback starts automatically. The screen shows the type of disc loaded as well as information about the disc's contents.
- While playing VCD with MTV/Karaoke, press number keys(0-9) to select the track and press **PI** or **ENTER** to play the track. Press **MENU** to go back to menu of the selection.

Playing DivX® disc

- Schneider provides you the DivX® VOD (Video on Demand) registration code that allows you to rent and purchase videos using the DivX® VOD service. For more information, visit www.divx.com/vod.
- Select the DivX® VOD on the Video Setup Page.
- The registration code will appear.
- Use the registration code to purchase or rent the videos from DivX® VOD service at www.divx.com/vod. Follow the instructions and download the video onto a CD-R for playback on this DVD player.



TIP

All the downloaded videos from DivX® VOD can only be played back on this DVD player.

Playing an MP3 CD

The following playback features are available for MP3 CDs. Please refer to the corresponding sections for more information. Volume control, skipping tracks, searching, repeat, shuffle, etc.

Use the ▲, ▼ keys to highlight your selected music folder. Press **ENTER** to play.

Playing a JPEG discs

Use the ▲, ▼, ◀, ▶ keys to highlight your selected picture folder. Press **ENTER**. The player will then automatically enter the slide show mode.

During playback, you can:

- Use the ▲, ▼, ◀, ▶ to rotate the picture.
- Use the ▲ to flip up/down.
- Use the ▼ to flip left/right.
- Press **MENU** to go back to folder screen.
- Press **■** to go to group preview.
- Use the ▲, ▼, ◀, ▶ to highlight the preview picture and access the on-screen functions.
- Press **ZOOM** repeatedly to display the picture with different scales.
- Use the ▲, ▼, ◀, ▶ to view the zoomed picture (for picture zoomed in only).

Note: Unless stated otherwise, all operations described are based on remote control operation.

GENERAL FEATURES

Moving to another title / track / chapter

When a disc has more than one title or track, you can move to another title/track/chapter as follows:

- Press **▶▶** briefly during play to select the next title/ track / chapter.
- Press **◀◀** briefly during play to step back to the previous title/track/chapter.
- To go directly to any title, track or chapter, enter the corresponding number using the numerical keys (0-9).

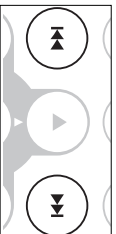

Search

During playback, press **▶▶** repeatedly for the following forward search options:
Press **◀◀** repeatedly for the following backward search options:

2 X backwards	2 X forward
4 X backwards	4 X forward
8 X backwards	8 X forward
16 X backwards	16 X forward
32 X backwards	32 X forward

normal speed normal speed

Press **ENTER** or **||** to resume normal playback.

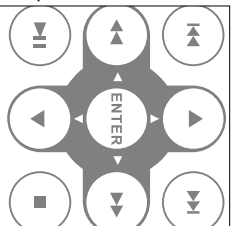

GENERAL FEATURES

Changing the audio output (for VCD/CD)

Press **AUDIO** repeatedly for the following audio options.

x 1	Mono left	x 2	Mono right
x 3	Stereo		



TIP

This key is used to select audio languages during DVD playback.



ZOOM

The Zoom function allows you to enlarge the video image and to pan through the enlarged image. Press **ZOOM** repeatedly to select the following zooming options.

Zoom x 1	2X	Zoom x 2	3X
Zoom x 3	4X	Zoom x 4	normal



TIP

During JPEG operation, the sequence is 100%, 125%, 150%, 200%, 50%, 75% and normal.

REPEAT

Press **REPEAT 1/ALL** repeatedly for the following repeat options:

Press REPEAT 1/ALL repeatedly for the following repeat options:	DVD actions	MP3 actions	CD actions	JPEG/DiVX actions
x 1	repeats chapter	repeats one	repeats track	repeats one
x 2	repeats title	repeats folder	repeats all	repeats all
x 3	repeats all	repeats all	repeats all	repeats all
x 4	repeats all	repeats all	repeats all	repeats all



TIP

The repeat function is also available for JPEG. The actions may vary for different media being played.

Repeat A - B

To repeat or loop a sequence in a title:

- Press **A - B** at your chosen starting point;
- ↳ **A** appears on the screen.
- Press **A - B** again at your chosen end point;
- ↳ **AB** appears on the display, and the repeat sequence begins.
- To exit the sequence, press **A - B**.

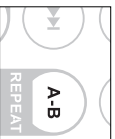
**Volume Control**

- Use the rotatory switch on the left side of the unit to increase or decrease playback volume.

**DISPLAY**

Press **DISPLAY** on the remote repeatedly for the following display options:

	DVD	CD/CD	DivX
x 1	Title elapsed	Single elapsed	Single elapsed
x 2	Title remained	Single remained	Single remained
x 3	Chapter elapsed	Total elapsed	Display off
x 4	Chapter remained	Total remained	
X5	Display off	Display off	



TIP

During JPEG operation, pressing this button enables you to select 17 slideshow modes.

Checking the contents of DVD-Video discs: **MENU**.

For titles and chapters, selection menus may be included on the disc. The DVD's menu feature allows you to make selections from these menus. Press the appropriate numerical key; or use the ▲, ▼, ⏪, ⏩ keys to highlight your selection, and press **ENTER**.

Disc menu

Press **MENU**. The menu may list, for example, camera angles, spoken language and subtitle options, and chapters for the title.

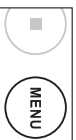

Playing a title

- 1 Press **MENU** to enter the disc title menu.
- 2 Use ⏪ ⏩ ⏴ ⏵ or **numeric keys (0-9)** to select a play option.
- 3 Press **ENTER** to confirm.

Changing the language

Press **AUDIO**. If the current disc has different language options, this now appears on the screen.

Press **AUDIO** repeatedly until you have reached your desired language option.

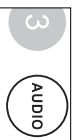

Subtitle

Press **SUB**. If the current disc has different subtitles options, this now appears on the screen.

Press **SUB** repeatedly until you have reached your desired subtitles option.



TIP

The above two features depend on whether your disc contains any language or subtitle options.

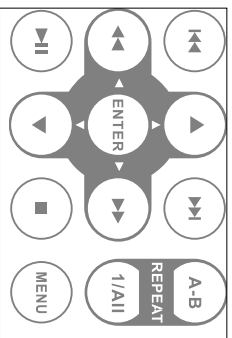

SETUP OPERATIONS

To maximize your playback experience, use **SETUP** to fine tune your settings. Use the ▲, ▼, ◀, ▶, ⏪, ⏩ keys to highlight your selection, and press **ENTER**.

- 1 Press **SETUP**. A list of features is shown.
- 2 Use the ▲ ▼ keys to highlight your selection.

When the cursor highlights these settings, press **ENTER** to:

General Setup Page select display and other options

Video Setup Page select video options

Password Setup Page select password options

Preference Page select playback preferences

Exit exit the system menu

3 Press ◀ to abort current settings or go back to previous menu level.

4 Press **SETUP** to exit.

General Setup Page

When the cursor highlights these settings, press **ENTER** to:

TV Display select display ratio

Angle Mark select angle mark display options

OSD Language select onscreen display language

Screen Saver select screen saver options

Last Memory select last playback memory options

Press ◀ to abort current settings or go back to previous menu level.

Note: Before using the ▲ ▼ keys to select your desired angle mark, ensure the disc has been recorded with angle mark and you have enabled the angle mark option in the system menu.

SETUP OPERATIONS

Video Setup Page

When the cursor highlights these settings, press **ENTER** to:

Brightness select brightness level

Contrast select contrast level

DivX® VOD get DivX ID for VOD

Press ◀ to abort current settings or go back to previous menu level

Password Setup Page

When the cursor highlights these settings, press **ENTER** to:

Password change existing password (3308 by default)

Press ◀ to abort current settings or go back to previous menu level

Note: Parental options are only selectable when password mode is deactivated.

Preference Page

When the cursor highlights these settings, press **ENTER** to:

Audio select audio language options

Subtitle select subtitle language options

Disc Menu select disc menu language options

Parental select parental options

Default restore factory settings

Press ◀ to abort current settings or go back to previous menu level.

TROUBLESHOOTING

If it appears that the DVD-Video player is faulty, first consult this checklist. It may be that something has been overlooked.

WARNING

Under no circumstances should you try to repair the set yourself as this will invalidate the guarantee.

If a fault occurs, first check the points listed, before taking the set for repair. If you are unable to solve a problem by following these hints, consult your dealer or service centre.

Symptom	Remedy
No power	<ul style="list-style-type: none">– Check if both plugs of the mains cord are properly connected.– Check if there is power at the AC outlet by plugging in another appliance.– Check if the built-in battery is drained.– Check if car adaptor is connected appropriately.
Distorted picture	<ul style="list-style-type: none">– Check the disc for fingerprints and clean with a soft cloth, wiping from centre to edge.– Sometimes a small amount of picture distortion may appear. This is not a malfunction.– The PAL setting may be in the wrong status. Match your TV's setting with the player's setting.
Completely distorted picture / no colour in the TV screen	<ul style="list-style-type: none">– Check audio connections. If using a HiFi amplifier, try another sound source.
No sound	

TROUBLESHOOTING

Symptom

Remedy

Disc can't be played

- Ensure the disc label is upwards.
- Clean the disc.
- Check if the disc is defective by trying another disc.

The player does not respond to the remote control

- Aim the remote control directly at the sensor on the front of the player. Avoid all obstacles that may interfere with the signal path. Inspect or replace the batteries.

Distorted or B/W picture with DVD

- Use only discs formatted according to the TV-set used (PAL).

Player does not respond to all operating commands during playback

- Operations are not permitted by the disc.
- Refer to the instructions in the disc inlay.

Player feels warm

- When the player is in use for a long period of time, the surface will be heated. This is normal.

Display goes dimmer when AC is unplugged

- The unit is saving power to ensure longer playtime with battery. It is normal. Adjust the brightness using the rotary brightness control.

This set complies with the radio interference requirements of the European Union.

TECHNICAL DATA

Dimensions	210 x 178 x 39 mm
Weight	0.79 kg / 0.36 pounds
Power supply	DC 9V 1.0A
Power Consumption	9W
Operating temperature range	0 - 45°C
Laser wavelength	650nm
Video system	PAL
Frequency response	20Hz ~ 20KHz ± 1dB
Signal/noise ratio	≥ 80dB
Audio distortion + noise	≤ -80(1KHz)
Channel separation	≥ 80dB
Dynamic range	≥ 80dB
Output	
Audio out (analog audio)	Output level: 2V ± 10%
Load impedance:	10KΩ
Video out Output level:	1Vp - p ± 20%
Load impedance:	75Ω

PHILIPS reserves the right to make design and specification changes for product improvement without prior notice.

Modifications not authorized by the manufacturer may void users authority to operate this device.

All rights reserved.



Need help?
Online

Go to www.philips.com/support



© Royal Philips Electronics N.V. 2007

Meet Philips at the Internet
<http://www.philips.com>



Printed in China
PDCC-2007