

Mini Hi-Fi System

FWM396

Register your product and get support at
www.philips.com/welcome

User manual

Manual do usuário

Manual del usuario



PHILIPS

México



Es necesario que lea cuidadosamente su instructivo de manejo.

	PRECAUCIÓN - ADVERTENCIA No abrir, riesgo de choque eléctrico	
	ATENCIÓN Verifique que el voltaje de alimentación sea el requerido para su aparato	
Para evitar el riesgo de choque eléctrico, no quite la tapa. En caso de requerir servicio, dirijase al personal calificado.		

Descripción: **Minisistema de Audio**
Modelo : **FWM396/55**
Alimentación: **110-127 / 220-240V; ~50/60 Hz**
Consumo: **110W**
Importador: **Philips Mexicana, S.A. de C.V.**
Domicilio: **Av. La Palma No.6
Col. San Fernando La Herradura
Huixquilucan**
Localidad y Tel: **Edo. de México C.P. 52784
Tel.52 69 90 00**
Exportador: **Philips Electronics HK, Ltd.**
País de Origen: **China**
N° de Serie: _____

**LEA CUIDADOSAMENTE ESTE INSTRUCTIVO
ANTES DE USAR SU APARATO.**

AVISO IMPORTANTE

Philips Mexicana, S.A. de C.V. no se hace responsable por daños o desperfectos causados por:

- Maltrato, descuido o mal uso, presencia de insectos o roedores (cucarachas, ratones etc.).*
- Cuando el aparato no haya sido operado de acuerdo con el instructivo del uso, fuera de los valores nominales y tolerancias de las tensiones (voltaje), frecuencia (ciclaje) de alimentación eléctrica y las características que deben reunir las instalaciones auxiliares.*
- Por fenómenos naturales tales como: temblores, inundaciones, incendios, descargas eléctricas, rayos etc. o delitos causados por terceros (choques asaltos, riñas, etc.).*

CAUTION

Use of controls or adjustments or performance of procedures other than herein may result in hazardous radiation exposure or other unsafe operation.

CAUTION

Use of controls or adjustments or performance of procedures other than herein may result in hazardous radiation exposure or other unsafe operation.



ATENCIÓN

El uso de mando o ajustes o la ejecución de métodos que no sean los aquí descritos puede ocasionar peligro de exposición a radiación.

CUIDADO

A utilização de comandos ou ajustes ou a execução de procedimentos diferentes dos descritos neste manual podem provocar uma exposição a radiações perigosas ou outras operações inseguras.

PLUG & PLAY
(for tuner installation)

- 
Plug in the unit
- 
Follow instructions in the display
- 
Press "PLAY"

Index

English 6

Español 24

Português 52

English

Español

Português

General Information

Supplied accessories	7
Environmental information	7
Safety information	7

Preparations

Rear connections	8–9
Power	
Antenna connection	
Speakers connection	
Optional connection	9
Inserting batteries into the remote control	9

Controls

Controls on the system	10
Controls on remote control	11

Basic Functions

Plug and Play	12
Switching the system on	12
Switching the system to standby mode	13
Power-saving automatic standby	13
Volume control	13
Sound control	13
MAC sound	
DSC (Digital Sound Control)	
DBB (Dynamic Bass Boost)	
Karaoke	13

CD/MP3-CD/WMA Operations

Discs for playback	14
About MP3 disc	14
Loading discs	14–15
Playing discs	15
Replacing discs during playback	15
Selecting a desired track/passage	15
Selecting a desired Album/Title (MP3/WMA disc only)	15
Different play modes: SHUFFLE and REPEAT	16
Programming the disc tracks	16
Erasing the programme	16

Radio Reception

Tuning to radio stations	17
Programming radio stations	17
Automatic programming	
Manual programming	
Tuning to preset radio stations	17

External Sources

Listening to external sources	18
-------------------------------------	----

Clock/Timer

Clock setting	19
Timer setting	19–20
To deactivate the TIMER	
To activate the TIMER	
Sleep timer setting	20

Specifications

.....	21
-------	----

Maintenance

.....	21
-------	----

Troubleshooting

.....	22–23
-------	-------

Congratulations on your purchase and welcome to Philips!

To fully benefit from the support that Philips offers, register your product at www.philips.com/welcome.

IMPORTANT!

PLEASE NOTE THAT THE VOLTAGE SELECTOR LOCATED AT THE REAR OF THIS SYSTEM IS PRESET AT 220V FROM THE FACTORY. FOR COUNTRIES THAT OPERATE AT 110V-127V, PLEASE ADJUST TO 110V-127V BEFORE YOU SWITCH ON THE SYSTEM.

Supplied accessories

- AC power cord
- 2 speaker boxes
- remote control
- MW loop antenna
- MP3 link cable

Environmental information

All unnecessary packaging has been omitted. We have tried to make the packaging easy to separate into three materials: cardboard (box), polystyrene foam (buffer) and polyethylene (bags, protective foam sheet).

Your system consists of materials which can be recycled and reused if disassembled by a specialised company. Please observe the local regulations regarding the disposal of packaging materials, exhausted batteries and old equipment.

Safety information

- Before operating the system, check that the operating voltage indicated on the typeplate (or the voltage indication beside the voltage selector) of your system is identical with the voltage of your local power supply. If not, please consult your dealer.
- Place the system on a flat, hard and stable surface.
- Where the MAINS plug or an appliance coupler is used as the disconnet device, the disconnet device shall remain readily operable.
- Place the system in a location with adequate ventilation to prevent internal heat build-up in your system. Allow at least 10 cm (4 inches) clearance from the rear and the top of the unit and 5 cm (2 inches) from each side.
- The ventilation should not be impeded by covering the ventilation openings with items, such as newspapers, table-cloths, curtains, etc.
- Do not expose the system, batteries or discs to excessive moisture, rain, sand or heat sources caused by heating equipment or direct sunlight.
- No naked flame sources, such as lighted candles, should be placed on the apparatus.
- No objects filled with liquids, such as vases, shall be placed on the apparatus.
- Don't expose the system to dripping or splashing.
- Install this unit near the AC outlet and where the AC power plug can be reached easily.
- The lens may cloud over when the system is suddenly moved from cold to warm surroundings, making it impossible to play a disc. Leave the system in the warm environment until the moisture evaporates.
- The mechanical parts of the set contain self-lubricating bearings and must not be oiled or lubricated.
- Batteries (battery pack or batteries installed) shall not be exposed to excessive heat such as sunshine, fire or the like.
- **When the system is switched to Standby mode, it is still consuming some power. To disconnect the system from the power supply completely, remove the AC power plug from the wall socket.**

Preparations

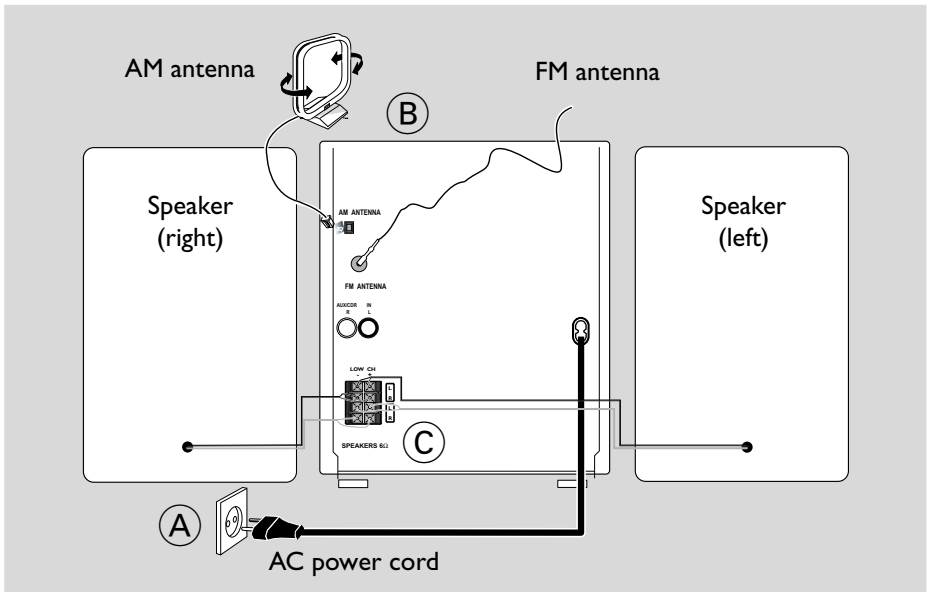

Rear connections

The type plate is located at the rear of the system.

(A) Power

Before connecting the AC power cord to the wall outlet, ensure that all other connections have been made.

If your system is equipped with a Voltage Selector, set the VOLTAGE SELECTOR to the local power line voltage.

WARNING!

- For optimal performance, use only the original power cable.
- Never make or change any connections with the power switched on.
- High voltage! Do not open. You run the risk of getting an electric shock.
- The machine does not contain any user-serviceable parts.
- Modification of the product could result in hazardous radiation of EMC or other unsafe operation.

To avoid overheating of the system, a safety circuit has been built in. Therefore, your system may switch to Standby mode

automatically under extreme conditions. If this happens, let the system cool down before reusing it (not available for all versions).

(B) Antennas Connection

Connect the supplied AM loop antenna to the AM ANTENNA terminal. Adjust the position of the antenna for optimal reception.

AM Antenna

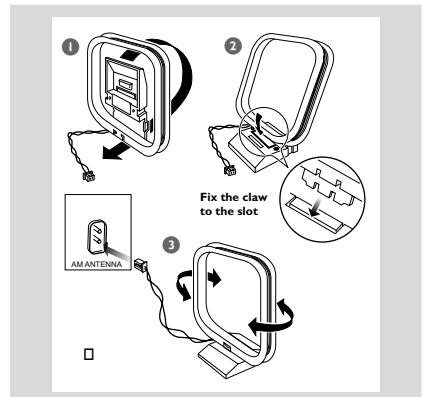

- Position the antenna as far as possible from a TV, VCR or other radiation source.

FM Antenna

It is unnecessary to connect the FM digital antenna since it is fixed to the main unit.

- Adjust the FM antenna for optimal FM stereo reception.

C Speakers Connection

Front Speakers

Connect the speaker wires to the SPEAKERS terminals, right speaker to "R" and left speaker to "L", coloured (marked) wire to "+" and black (unmarked) wire to "-".

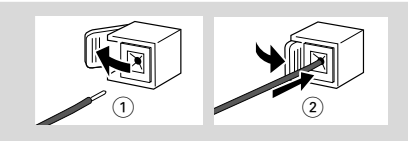

- Fully insert the stripped portion of the speaker wire into the terminal as shown.

Notes:

- For optimal sound performance, use the supplied speakers.
- Do not connect more than one speaker to any one pair of + / - speaker terminals.
- Do not connect speakers with an impedance lower than the speakers supplied. Please refer to the SPECIFICATIONS section of this manual.

Optional connection

The optional equipment and connecting cords are not supplied. Refer to the operating instructions of the connected equipment for details.

Connecting other equipment to your system

Using AUX IN (white/red jacks)

- Use the audio cables (white/red, not supplied) to connect **AUX IN (L/R)** jacks of the main unit (located on the back panel) to the corresponding AUDIO OUT jacks on an external device (such as TV or VCR).

Note:

- If you are connecting equipment with a mono output (a single audio out terminal), connect it to the AUX left terminal. Alternatively, you can use a "single to double" cinch cable (the output sound still remain mono).

Using MP3 LINK (3.5 mm jack)

- Use a MP3 link cable (supplied) to connect **MP3 LINK** jack of the main unit (3.5 mm, located on the front panel) to an AUDIO OUT or headphone jack on an external equipment (such as CD player, or VCR).

Inserting batteries into the remote control

Insert two batteries (Type R03 or AAA, not supplied) into the remote control with the correct polarity as indicated by the "+" and "-" symbols inside the battery compartment.

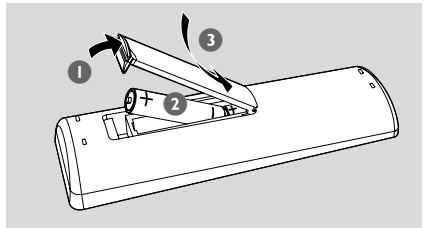

CAUTION!

- Remove batteries if they are exhausted or will not be used for a long time.
- Do not use old and new or different types of batteries in combination.
- Batteries contain chemical substances, so they should be disposed of properly.

Controls on the system

① Disc tray

- to view the current status of the system.

③ Mode Selection

ALBUM/PRESET +/-

for MP3-CD to select previous/next album.

for Tuner to select a preset radio station

for Clock/Timer to set the minute.



for CD/ MP3-CD .. to stop playback or to clear a programme.

for Clock to exit clock setting.



for CD/ MP3-CD .. to start or interrupt playback.



for MP3-CD to select previous/next title.

for CD to skip to the beginning of the current, previous, or next track.

for CD/ MP3-CD .. (press and hold) to search backward/forward.

for Tuner to tune to a lower or higher radio frequency.

for Clock/Timer to set the hour.

④ CLOCK/TIMER

- to set the clock/timer.

⑤

- switches the system on or to standby mode.

⑥ Source selection – to select the following:

DISC

- to select disc tray 1, 2 or 3.

TUNER

- to select waveband: FM or MW.

MP3 LINK

- to select the input for an additional appliance: MP3 LINK.

AUX

- to select the input for an additional appliance: AUX.

⑦ MAX SOUND

- to activate or deactivate the optimal mix of various sound features.

⑧ DSC (Digital Sound Control)

- Selects different types of preset sound equaliser settings (OPTIMAL, TECHNO, ROCK or JAZZ).

⑨ MP3 LINK jack

- Connects an external device.

⑩ DBB

- to select the desired bass boost level. (DBB 1, DBB 2, DBB 3 or DBB OFF).

⑪ MIC

- to connect microphone

⑫ MICVOL

- to adjust the mixing level for Karaoke

⑬ VOLUME

- to increase or decrease the volume.

⑭ PROG

- for CD/ MP3-CD .. to programme disc tracks.
- for Tuner to programme preset radio stations.

⑮ DISC 1/2/3

- to select a disc tray for playback.

⑯ OPEN-CLOSE

- to open or close the disc tray.

⑰ DISC CHANGE

- to change disc(s).

⑱ iR

- infrared sensor for remote control.

Controls on remote control

① POWER

- switches the system on or to standby mode.

② Source selection – to select the following:

DISC 1/2/3

- to select disc tray 1, 2 or 3.

TUN

- to select waveband: FM or MW.

Line-in (MP3 LINK)

- to select the input for an additional appliance: MP3 LINK.

AUX

- to select the input for an additional appliance: AUX.

③ MODE

- selects different play modes: e.g. REPEAT or SHUFFLE (random order).

④ TIMER ON/OFF

- to turn on or off the timer

⑤ MAX

- to activate or deactivate the optimal mix of various sound features.

⑥ Mode Selection



for CD/ MP3-CD .. to start or interrupt playback.



for CD/ MP3-CD .. to search backward/forward.
for Tuner to tune to a lower or higher radio frequency.

for Clock/Timer to set the hour.



for MP3-CD to select previous/next title.
for CD to skip to the beginning of the current, previous, or next track.

⑦ DSC

- Selects different types of preset sound equaliser settings (OPTIMAL, TECHNO, ROCK or JAZZ).

⑧ ■

for CD/ MP3-CD .. to stop playback or to clear a programme.
for Clock to exit clock setting.

⑨ ALB/PRESET -/+

for MP3-CD to select previous/next album.

for Tuner to select a preset radio station

for Clock/Timer to set the minute.

⑩ MUTE

- to mute or restore the volume.

⑪ Numeric Keypad (0-9)

- to input a track number of the disc.

⑫ PROG

for CD/ MP3-CD .. to programme disc tracks.

for Tuner to programme preset radio stations.

⑬ CLOCK

- to set the clock.

⑭ VOL +/-

- to increase or decrease the volume.

⑮ DBB

- to select the desired bass boost level. (DBB 1, DBB 2, DBB 3 or DBB OFF).

⑯ DISPLAY

for CD/ MP3-CD

..... displays the current track remaining time and total remaining time (or current album and track name and ID3 for MP3 disc) during playback.

for Clock to view the clock.

⑰ TIMER

- activates/deactivates the timer function.

⑱ SLEEP

- to activate/deactivate or set the sleep timer.

Notes for remote control:

– **First, select the source you wish to control by pressing one of the source select keys on the remote control (DISC or TUN, for example).**

– **Then select the desired function (▶ II, ◀, ▶, for example).**

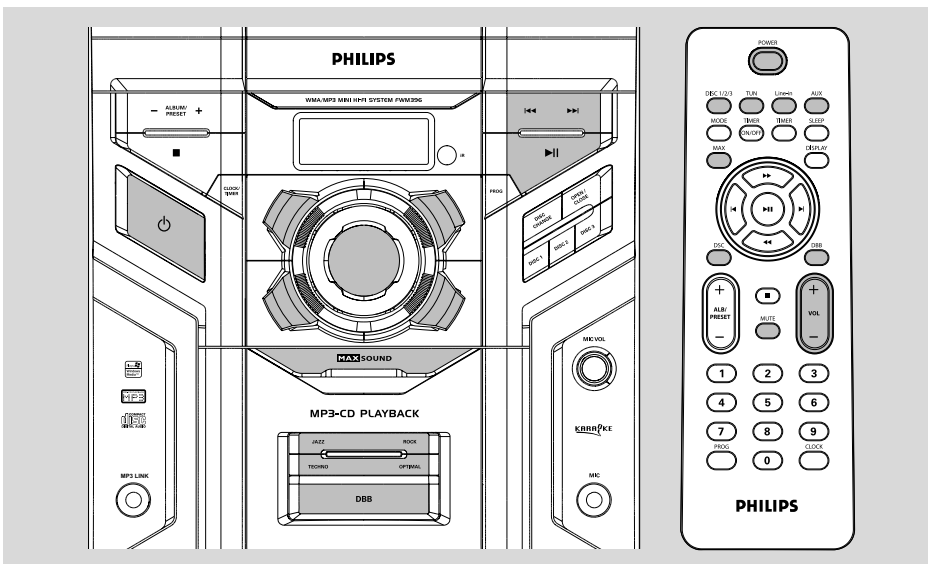

IMPORTANT!

Before you operate the system, complete the preparation procedures.

Plug and Play (for tuner installation)

Plug and Play allows you to store all available radio stations automatically.

First time setup/power up

- 1 When you turn on the main supply, "AUTO INSTALL - PRESS PLAY" is displayed.
- 2 Press ►|| to start installation.
 - "PLUG AND PLAY" "INSTALL" is displayed, followed by "AUTO".
 - All available radio stations with sufficient signal strength will be stored automatically, starting from FM and followed by AM band.
 - When all the available radio stations are stored or the memory for 40 presets are used, the first preset radio station will be played.

To reinstall Plug and Play

- 1 In standby mode, press and hold ►|| until "AUTO INSTALL - PRESS PLAY" is displayed.
- 2 Press ►|| again to start installation.
 - All previously stored radio stations will be replaced.

To exit without storing the Plug and Play

- Press ■ .
 - If you do not complete the Plug and Play installation, the function will be restarted when you next turn on the main supply again.

Notes:

- When the power is turned on, the disc tray may open and close to initialise the system.
- If no stereo frequency is detected during Plug and Play, "CHECK ANTENNA" will be displayed.
- During Plug and Play, if no button is pressed within 15 seconds, the system will exit Plug and Play mode.

Switching the system on

- Press ⏻ (or **POWER** on the remote control).
 - The system will switch to the last selected source.
- Press **DISC, TUNER, MP3 LINK** or **AUX (DISC1/2/3, TUN, Line-in (MP3 LINK) or AUX** on the remote control).
 - The system will switch to the selected source.
- Press **OPEN-CLOSE** or **DISC CHANGE**.
 - The system will switch to the disc source and the disc tray will open.

Switching the system to standby mode

In any other source mode

- Press **⏻** (or **POWER** on the remote control).
→ The clock will appear on the display when the system is in standby mode.

Power-saving automatic standby

As a power-saving feature, the system will automatically switch to Standby mode if you do not press any buttons within 15 minutes after a disc or tape has stopped playing.

Volume control

Adjust **VOLUME** to increase (turn knob clockwise or press **VOL +** on the remote control) or decrease (turn knob anti-clockwise or press **VOL -** on the remote control) the sound level.

To switch off the volume temporarily

- Press **MUTE** on the remote control.
→ Playback will continue without sound and the mute icon is displayed.
- To restore the volume, press **MUTE** again or increase/decrease the volume level.

Sound control

MAX Sound

MAX sound provides the best mixture of various sound features (DSC, DBB, for example).

- Press **MAX SOUND** (or **MAX** on the remote control) repeatedly.
→ If activated, **MAX** is shown.
→ If deactivated, **MAX** disappears.

DSC (Digital Sound Control)

The DSC feature enables you to enjoy special sound effects that have preset equaliser settings, providing the best music reproduction.

- ① Press **DSC** to select : OPTIMAL, TECHNO, ROCK or JAZZ.
→ The selected DSC is shown.

DBB (Dynamic Bass Boost)

There are three DBB settings to enhance the bass response.

- ① Press **DBB** on the remote control to select : DBB 1, DBB 2, DBB 3 or DBB OFF.
→ The selected **DBB** is shown, except for DBB OFF mode.

Note:

– *Some discs or tapes might be recorded in high modulation, which causes a distortion at high volume. If this occurs, switch off DBB or reduce the volume.*

Automatic DSC-DBB selection

The best DBB setting is generated automatically for each DSC selection. You can manually select the DBB setting that best suits your listening environment.

DSC	DBB
JAZZ	off
ROCK	on (2)
TECHNO	on (3)
OPTIMAL	on (1)

Karaoke

Connect a microphone (not supplied) to the system allowing you to sing along with the music source.

- ① Connect a microphone to the **MIC** jack.
- Before connecting the microphone, set the microphone **MIC VOL** to the minimum level to prevent howling sound.
- ② Press **DISC, TUNER, MP3 LINK** or **AUX** (**DISC1/2/3, TUN, Line-in** (MP3 LINK) or **AUX** on the remote control) to select the source to be mixed and start playback.
- ③ Adjust the volume level of the source with **VOLUME** control.
- ④ Adjust the microphone volume with the microphone **MIC VOL** control.

Note:

– *Keep the microphone away from the speakers to prevent howling.*

CD/MP3-CD/WMA Operations

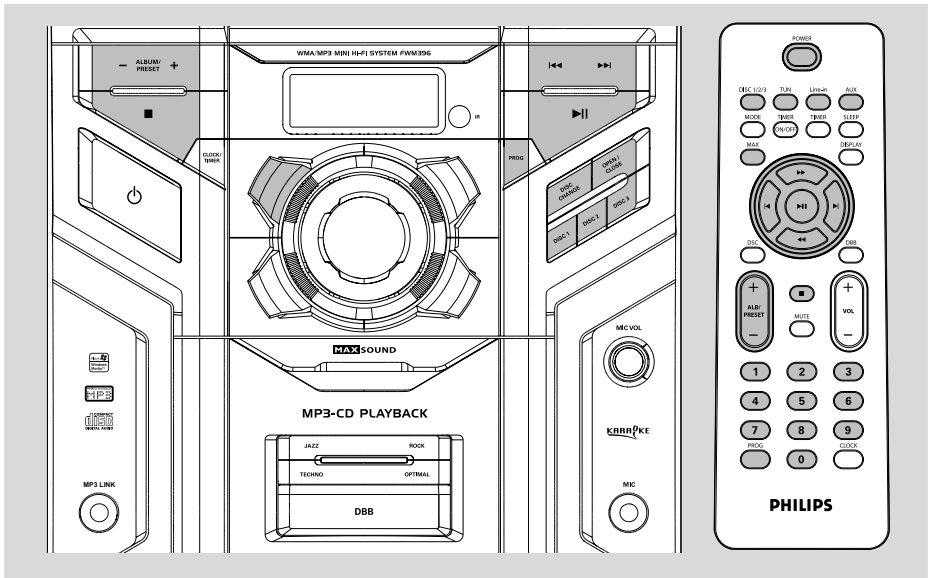

IMPORTANT!

- This system is designed for regular discs. Therefore, do not use any accessories such as disc stabiliser rings or disc treatment sheets, etc., as offered on the market, because they may jam the changer mechanism.
- Do not load more than one disc into each tray.

Discs for playback

This system can playback all digital audio CD, finalised digital audio CD-Recordable (CDR) discs and finalised digital audio CD-Rewritable (CDRW) discs.

MP3-CDs/WMA (CD-ROMs with MP3/WMA tracks)

* DRM-protected WMA is not supported.



About MP3 disc

Supported formats

- ISO9660, Joliet, Multisession
- Max. track number plus album is 512
- The max. MP3 program track number is 40
- Supported VBR bit-rate
- Supported sampling frequencies for MP3 disc are: 32 kHz, 44.1 kHz, 48 kHz
- Supported Bit-rates of MP3 disc are: 32, 64, 96, 128, 192, 256 (kbps)

Loading discs

- 1 Press **OPEN-CLOSE** to open the disc tray.
- 2 Load up to two discs on the individual disc trays. To load the third disc, press **DISC CHANGE**.
→ The disc tray will rotate until the empty tray is ready for loading.

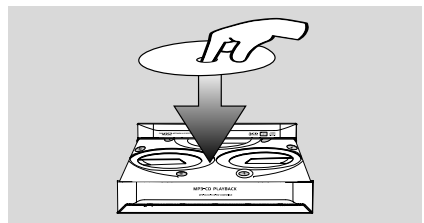

- 3 Press **OPEN•CLOSE** to close the disc tray.
 → **READING** is displayed as the CD player scans the contents of a disc, and then the total number of tracks and playing time (or the total number of albums and tracks for MP3/WMA disc) are shown.

Notes:

- Load the discs with the label side facing up.
- To ensure good system performance, wait until the disc tray completely reads the disc(s) before proceeding.
- For MP3/WMA disc, the disc reading time may exceed 10 seconds due to the large number of songs compiled into one disc.

Playing discs

To play current disc on the disc tray

- Press **▶ II**.
 → All loaded discs will play once, then stop.
 → During playback, the selected disc tray, track number and elapsed playing time of the current track are displayed.
 → For mixed mode discs, only one mode will be selected for playback depending on the recording format.

Note:

–When playing a mixed mode disc, you may find a very short mute track inserted into the total number of tracks available in your disc.

To play the selected disc only

- In CD mode, press **DISC** (or **DISC 1/2/3** on the remote control).
 → The current disc will play once, then stop.

To interrupt playback

- Press **▶ II**.
 → The display freezes and the elapsed playing time flashes when playback is interrupted.
- To resume playback, press **▶ II** again.

To stop playback

- Press **■**.

Replacing discs during playback

- 1 Press **DISC CHANGE**.
 → The disc tray will open without interrupting current playback.
- 2 To change the inner disc, press **DISC CHANGE** again.
 → "CHANGE" and "OPEN" are displayed and the disc will stop playing.
 → The disc tray will close to retrieve the inner disc, then reopen with the inner disc accessible.

Selecting a desired track/passage

To search for a particular passage during playback

- Press and hold **◀◀ / ▶▶** (or **◀ / ▶** on the remote control) and release it when the desired passage is located.
 → During searching, the volume will be muted.

To select a desired track

- Press **◀◀ / ▶▶** (or **◀ / ▶** on the remote control) repeatedly until the desired track is displayed.
- If playback is stopped, press **▶ II** to start playback.

Selecting a desired Album/Title (MP3/WMA disc only)

To select a desired album





- Press **ALBUM/PRESET +/-** (or **ALB/PRESET +/-** on the remote control) repeatedly.





To select a desired title

- Press **◀◀ / ▶▶** (or **◀ / ▶** on the remote control) repeatedly.

Different play modes: SHUFFLE and REPEAT











You can select and change the various play modes before or during playback. The play modes can also be combined with PROGRAM.

-  plays the current track continuously
-  **ALB** plays the current album continuously
-  **ALL** repeats the entire disc/programme
-  tracks of the entire disc are played in random order

- 1 To select your play mode, press the **MODE** button before or during playback until the display shows the desired function.
- 2 Press  to start playback if in the STOP position.
- 3 To return to normal playback, press the **MODE** button until  or  is no longer displayed.
- You can also press  to cancel your play mode.

Programming the disc tracks





Programming tracks is possible when playback is stopped. Up to 40 tracks can be stored in the memory in any order.

- 1 Load the desired discs on the disc tray (refer to "Loading discs").
- 2 Press **DISC** (or **DISC 1/2/3** on the remote control) to select a disc.
- 3 In stop mode, press **PROG** to start programming.
→ **PROG** starts flashing.
- 4 Press   (or  /  on the remote control) repeatedly to select the desired track.
- For MP3/WMA disc, press **ALBUM/PRESTE - I+** and   (or  /  on the remote control) to select the desired album and title for programming.
- 5 Press **PROG** to store the track.
- 6 To end programming, press  **once**.
→ **PROG** stays and the programme mode remains active.
- 7 To start programme play, press .

Notes:

- It is not possible to create a programme with MP3 tracks from multiple CDs, or combined with normal audio tracks.
- If you attempt to programme more than 40 tracks, "PROGRAM FULL" is displayed.
- During programming, if no button is pressed within 90 seconds, the system will exit the programme mode automatically.

To review the programme

- Stop playback and press   (or  /  on the remote control) repeatedly.
- To exit review mode, press .

Erasing the programme

- Press  **once** when playback is stopped or **twice** during playback.
→ **PROG** disappears and "PROG CLEAR" is displayed.

Note:

- The programme will be erased when the system is disconnected from the power supply or when the disc tray is opened.

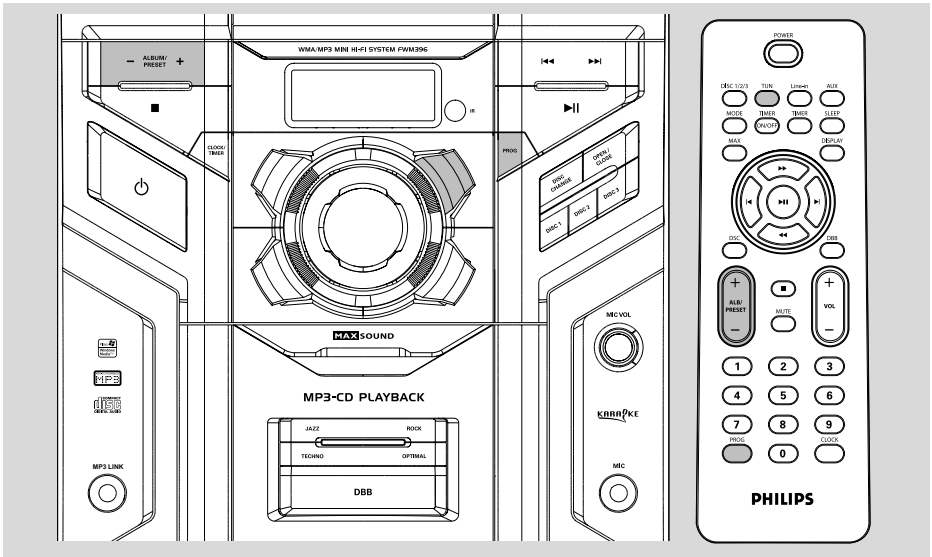

Tuning to radio stations

- 1 Press **TUNER** (or **TUN** on the remote control).
- 2 Hold **◀◀ / ▶▶** (or **◀ / ▶** on the remote control) and then release the button.
→ The system will start searching for a radio station with sufficient signal strength.
- 3 Repeat step 2 if necessary until you find the desired station.
- To tune to a weak station, press **◀◀ / ▶▶** (or **◀ / ▶** on the remote control) briefly and repeatedly until you have found optimal reception.

Programming radio stations

You can store up to a total of 40 radio stations in the memory.

Automatic programming

- 1 Press **TUNER** (or **TUN** on the remote control) to select TUNER mode.
- 2 Press and hold **PROG** until "AUTO" is displayed.
→ **PROG** starts flashing.
→ **AUTO** is displayed and available stations are programmed in order of waveband reception strength.
→ When all the available radio stations are stored or the memory for 40 presets are used, the first preset radio station will be played.

To stop storing the automatic preset

- Press **■**.

Manual programming

- 1 Tune to your desired station (refer to "Tuning to radio stations").
- 2 Press **PROG** to activate programming.
→ **PROG** flashes in the display.
- 3 Press **ALBUM/PRESET +/-** on the system (or **ALB/PRESET +/-** on the remote control) to allocate a number from 1 to 40 to this station.
- 4 Press **PROG** again to confirm the setting.
→ The preset number and the frequency of the preset station are shown.
- 5 Repeat the above four steps to store other stations.
- You can override a preset station by storing another frequency in its place.

Tuning to preset radio stations

- Press **ALBUM/PRESET +/-** (or **ALB/PRESET +/-** on the remote control) until the desired preset station is displayed.

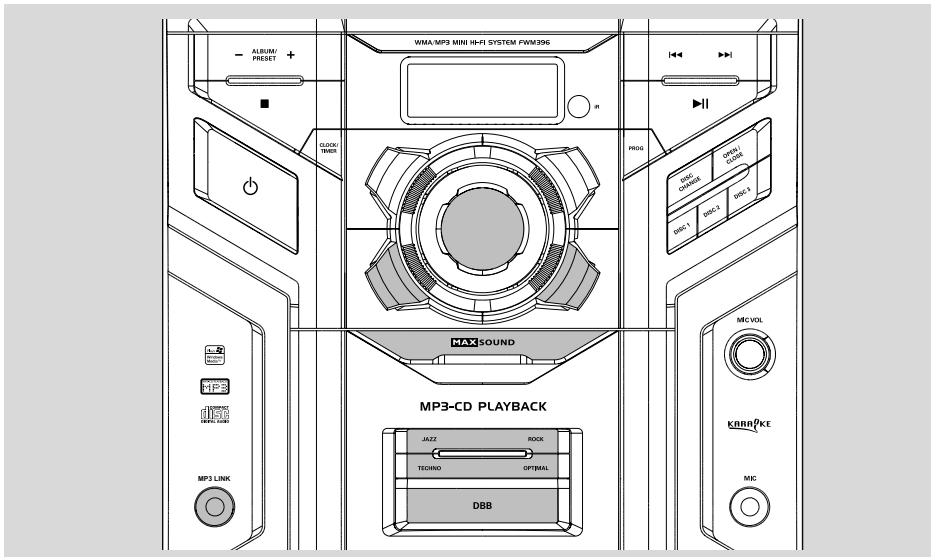

Listening to external sources

Using AUX IN (white/red jacks)

- 1 Use the audio cables (white/red, not supplied) to connect **AUX IN (L/R)** jacks of the main unit (located on the back panel) to the corresponding **AUDIO OUT** jacks on an external device (such as TV or VCR).
- 2 Press **AUX** to select AUX..

Using MP3 LINK (3.5 mm jack)

- 1 Use a MP3 link cable (supplied) to connect **MP3 LINK** jack of the main unit (3.5 mm, located on the front panel) to an **AUDIO OUT** or headphone jack on an external equipment (such as CD player; or VCR).
- 2 Press **MP3 LINK** (or **Line-in** (MP3 LINK) on the remote control) to select MP3 LINK.

Note:

- All the sound control features (DSC or DBB, for example) are available for selection.
- Refer to the operating instructions for the connected equipment for details.

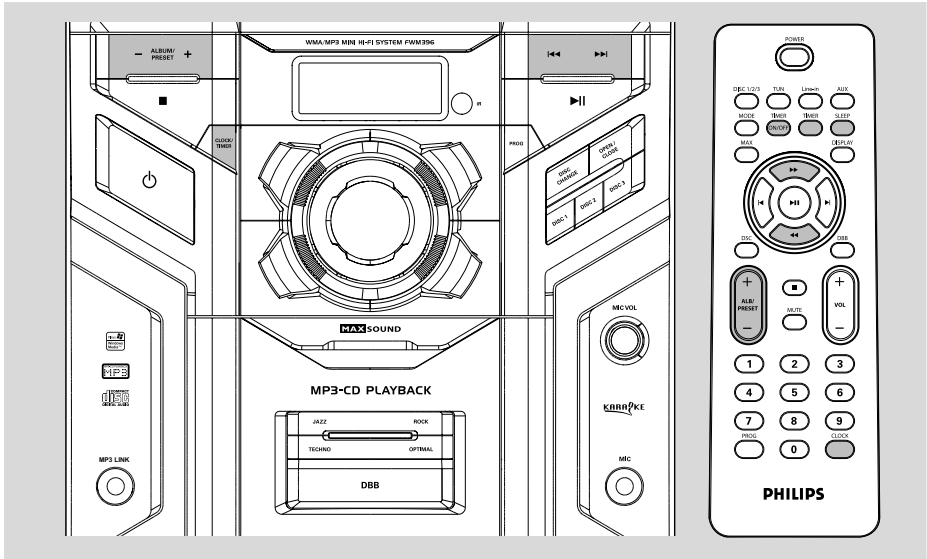

Clock setting

The clock can be set in either 12-hour or 24-hour mode ("PM 12:00" or "00:00" for example).

- 1 In standby or view clock mode, press **CLOCK/TIMER** (or **CLOCK** on the remote control) on the remote control.
- 2 Press **PROG** to select clock mode.
- 3 Press **CLOCK/TIMER** (or **CLOCK** on the remote control) to activate to adjust clock time.
- 4 Press **◀◀ / ▶▶** (or **◀ / ▶** on the remote control) repeatedly to set the hour.
- 5 Press **ALBUM/PRESET +/-** (or **ALB/PRESET +/-** on the remote control) repeatedly to set the minute.
- 6 Press **CLOCK/TIMER** (or **CLOCK** on the remote control) again to store the setting.
→ The clock starts working.

To exit without storing the setting

- Press **■**.

Notes:

- The clock setting will be cancelled when the power cord is disconnected or if a power failure occurs.
- During clock setting, if no button is pressed within 90 seconds, the system will exit clock setting mode automatically.

Timer setting

The system can switch on to CD or TUNER mode automatically at a preset time, serving as an alarm to wake you up.

IMPORTANT!

– Before setting the timer, ensure that the clock is set correctly.

- 1 In standby mode, press and hold **CLOCK/TIMER** (or **TIMER** on the remote control) on the remote control for more than **two seconds** to select timer mode.
→ The last timer setting starts flashing.
→ The selected source will be lighted.
- 2 Press **DISC 1/2/3** or **TUNER** to select the desired source.
- Before setting timer, make sure the music source has been prepared.
CD – Load the disc(s).
TUNER – tune to the desired radio station.
- 3 Press **CLOCK/TIMER** (or **TIMER** on the remote control) to activate to adjust time.
- 4 Press **◀◀ / ▶▶** (or **◀ / ▶** on the remote control) repeatedly to set the hour for the timer to start.

- 5 Press **ALBUM/PRESET +/-** (or **ALB/PRESET +/-** on the remote control) repeatedly to set the minute for the timer to start.
 - 6 Press **CLOCK/TIMER** (or **TIMER** on the remote control) to store the start time.
- At the preset time, the selected source will play.

To exit without storing the setting

- Press **■** on the system.

Notes:

- When the preset time is reached and the selected disc tray is empty, the next available disc will be selected. If all the disc trays are not available, Tuner will be selected automatically.
- During timer setting, if no button is pressed within 90 seconds, the system will exit timer setting mode automatically.

To deactivate the TIMER

- Press **TIMER ON/OFF** on the remote control.
→  disappears from the display.

To activate the TIMER

- Press **TIMER ON/OFF** on the remote control.
→  appears on the display.

Sleep timer setting

The sleep timer enables the system to switch to standby mode automatically at a preset time.

- 1 In active mode, press **SLEEP** on the remote control repeatedly to select a preset time.
→ The selections are as follows (time in minutes):
15 → 30 → 45 → 60 → 90 → 120 → OFF → 15 ...
- 2 When you reach the desired length of time, stop pressing the **SLEEP** button.
→ **ZZZ** is shown, except for "OFF" mode.
→ The sleep timer is now set.

To check the remaining length of time after sleep timer is activated

- Press **SLEEP** once.

To change the preset sleep timer

- Press **SLEEP** again while the remaining sleep timer is shown.
→ The display will show the next sleep timer options.

To deactivate the sleep timer

- Press **SLEEP** repeatedly until "OFF" is displayed, or press **⏻** (or **POWER** on the remote control).

Note:

- **ZZZ** will start flashing when the remaining length of time after activation of the sleep timer is less than 1 minute.

AMPLIFIER

1 kHz
(low channel - both channels driven)
..... 50 W per channel (6 Ω)

10 kHz
(high channel - both channels driven)
..... 50 W per channel (6 Ω)

Total output power 200 W

Signal-to-noise ratio ≥ 60 dBA (IEC)

Frequency response 50 – 16000 Hz

Input sensitivity

AUX/Line In 2 V

Microphone 1.5 mV

Output

Speakers ≥ 6 Ω
(1) (6 Ω, 1 kHz, 10%THD)

CD/MP3-CD PLAYER

Number of programmable tracks 40

Frequency response 50 – 16000 Hz -3dB

Signal-to-noise ratio ≥ 60 dBA

Channel separation ≥ 50 dB (1 kHz)

Total harmonic distortion < 0.6%

MPEG 1 Layer 3 (MP3-CD) MPEG AUDIO

MP3-CD bit rate 32-256 kbps
(128 kbps advised)

Sampling frequencies 32, 44.1, 48 kHz

TUNER

FM wave range 87.5 – 108 MHz

AM wave range (9 kHz) 531 – 1602 kHz

SPEAKERS

System 1-way; 1 port bass reflex

Impedance 6 Ω

Woofer 1 x 5"

Tweeter 1 x 1.5"

Dimensions (w x h x d) .. 207 x 309 x 214 (mm)

Weight 2.8 kg each

GENERAL

Material/finish Polystyrene/Metal

AC Power 110 – 127 / 220 – 240 V;
..... 50/60 Hz Switchable

Power Consumption

Active 110 W

Dimensions (w x h x d) .. 265 x 310 x 403 (mm)

Weight (without speakers) 5.9 kg

Specifications and external appearance are subject to change without notice.

Maintenance

Cleaning the Cabinet

- Use a soft cloth slightly moistened with a mild detergent solution. Do not use a solution containing alcohol, spirits, ammonia or abrasives.

Cleaning Discs

- When a disc becomes dirty, clean it with a cleaning cloth. Wipe the disc from the centre out.
- Do not use solvents such as benzene, thinner; commercially available cleaners, or antistatic spray intended for analogue records.



Cleaning the disc lens

- After prolonged use, dirt or dust may accumulate at the disc lens. To ensure good playback quality, clean the disc lens with Philips CD Lens Cleaner or any commercially available cleaner. Follow the instructions supplied with cleaner.

Troubleshooting

WARNING

Under no circumstances should you try to repair the system yourself, as this will invalidate the warranty. Do not open the system as there is a risk of electric shock.

If a fault occurs, first check the points listed below before taking the system for repair. If you are unable to remedy a problem by following these hints, consult your dealer or Philips for help.

Problem	Solution
“NO DISC” is displayed.	<ul style="list-style-type: none">✓ Insert a disc.✓ Check if the disc is inserted upside down.✓ Wait until the moisture condensation at the lens has cleared.✓ Replace or clean the disc, see “Maintenance”.✓ Use a finalized CD-RW or a correct MP3-CD format disc.
“DISC NOT FINALIZED” is displayed.	<ul style="list-style-type: none">✓ Use a finalised CD-RW or CD-R.
Radio reception is poor.	<ul style="list-style-type: none">✓ If the signal is too weak, adjust the antenna or connect an external antenna for better reception.✓ Increase the distance between the Mini HiFi System and your TV or VCR.
The system does not react when buttons are pressed.	<ul style="list-style-type: none">✓ Remove and reconnect the AC power plug and switch on the system again.
Sound cannot be heard or is of poor quality.	<ul style="list-style-type: none">✓ Adjust the volume.✓ Check that the speakers are connected correctly.✓ Check if the stripped speaker wire is clamped.✓ Make sure the MP3-CD was recorded within 32-256 kbps bit rate with sampling frequencies at 48 kHz, 44.1 kHz or 32 kHz.
The left and right sound outputs are reversed.	<ul style="list-style-type: none">✓ Check the speaker connections and location.

The remote control does not function properly.

- ✓ Select the source (DISC or TUN, for example) before pressing the function button (▶||, ◀◀, ▶▶).
- ✓ Reduce the distance between the remote control and the system.
- ✓ Insert the batteries with their polarities (+/- signs) aligned as indicated.
- ✓ Replace the batteries.
- ✓ Point the remote control directly towards the IR sensor.

The time is not working.

- ✓ Set the clock correctly.
- ✓ Press **TIMER ON/OFF** to switch on the timer.

The Clock/Timer setting is erased.

- ✓ Power has been interrupted or the power cord has been disconnected. Reset the clock/timer.

Visite a Philips na Internet
<http://www.philips.com>

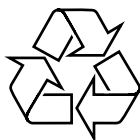

FWM396

