

# Mini Hi-Fi System

FWM397

Register your product and get support at  
[www.philips.com/welcome](http://www.philips.com/welcome)

User manual



# PHILIPS



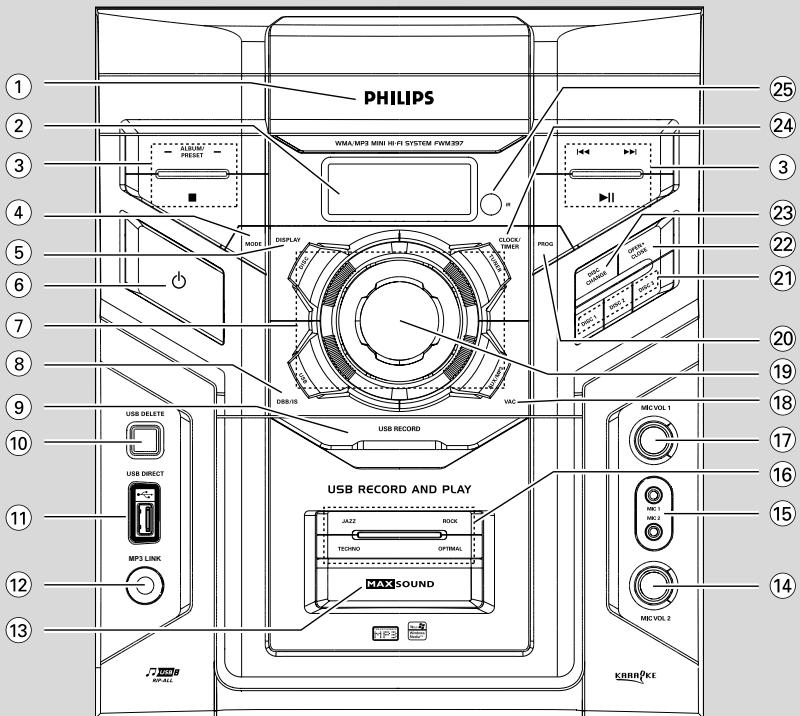
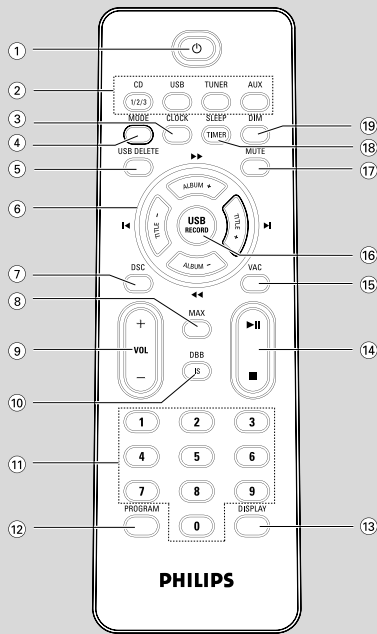



## CAUTION

*Use of controls or adjustments or performance of procedures other than herein may result in hazardous radiation exposure or other unsafe operation.*

**PLUG & PLAY**  
(for tuner installation)

-   
Plug in the unit
-   
Follow instructions in the display
-   
Press "PLAY"

English .....	6
---------------	---

---

## General Information

Supplied accessories .....	7
Environmental information .....	7
Safety information .....	7

---

## Preparations

Rear connections .....	8~9
Power	
Antenna connection	
Speakers connection	
Optional connection .....	9~10
Connecting a USB device or memory card	
Connecting other equipment to your system	
Inserting batteries into the remote control .....	10

---

## Controls

Controls on the system .....	11
Controls on remote control .....	12

---

## Basic Functions

Plug and Play .....	13
Switching the system on .....	13
Switching the system to standby mode .....	14
Power-saving automatic standby .....	14
Dim mode .....	14
Volume control .....	14
Sound control .....	14~15
MAC sound	
DSC (Digital Sound Control)	
DBB (Dynamic Bass Boost)	
Incredible Surround	
Karaoke .....	15

---

## CD/MP3-CD/WMA Operations

Discs for playback .....	16
About MP3 disc .....	16
Loading discs .....	16~17
Playing discs .....	17
Replacing discs during playback .....	17
Selecting a desired track/passage .....	17
Selecting a desired Album/Title (MP3/WMA disc only) .....	17
Different play modes: SHUFFLE and REPEAT ... ..	18
.....	18
Programming the disc tracks .....	18
Erasing the programme .....	18

---

## Radio Reception

Tuning to radio stations .....	19
Programming radio stations .....	19~20
Automatic programming	
Manual programming	
Tuning to preset radio stations .....	20

---

## USB

Using a USB mass storage device .....	21~22
Ripping function .....	23
Tuner record timer setting .....	24
To deactivate the TIMER	
To activate the TIMER	

---

## External Sources

Listening to external sources .....	25
-------------------------------------	----

---

## Clock/Timer

Clock setting .....	26
Timer setting .....	26~27
To deactivate the TIMER	
To activate the TIMER	
Sleep timer setting .....	27

---

## Maintenance .....

.....	28
Specifications .....	29

---

## Troubleshooting .....

.....	30~31
-------	-------

Congratulations on your purchase and welcome to Philips!

To fully benefit from the support that Philips offers, register your product at [www.philips.com](http://www.philips.com)/welcome.

## **IMPORTANT!**

**PLEASE NOTE THAT THE VOLTAGE SELECTOR LOCATED AT THE REAR OF THIS SYSTEM IS PRESET AT 220V FROM THE FACTORY. FOR COUNTRIES THAT OPERATE AT 110V-127V, PLEASE ADJUST TO 110V-127V BEFORE YOU SWITCH ON THE SYSTEM.**

## **Supplied accessories**

- AC power cord
- 2 speaker boxes
- remote control
- AM loop antenna
- FM wire antenna
- MP3 link cable

## **Environmental information**

All unnecessary packaging has been omitted. We have tried to make the packaging easy to separate into three materials: cardboard (box), polystyrene foam (buffer) and polyethylene (bags, protective foam sheet).

Your system consists of materials which can be recycled and reused if disassembled by a specialised company. Please observe the local regulations regarding the disposal of packaging materials, exhausted batteries and old equipment.

## **Safety information**

- Before operating the system, check that the operating voltage indicated on the typeplate (or the voltage indication beside the voltage selector) of your system is identical with the voltage of your local power supply. If not, please consult your dealer.
- Place the system on a flat, hard and stable surface.
- Where the MAINS plug or an appliance coupler is used as the disconnet device, the disconnet device shall remain readily operable.
- Place the system in a location with adequate ventilation to prevent internal heat build-up in your system. Allow at least 10 cm (4 inches) clearance from the rear and the top of the unit and 5 cm (2 inches) from each side.
- The ventilation should not be impeded by covering the ventilation openings with items, such as newspapers, table-cloths, curtains, etc.
- Do not expose the system, batteries or discs to excessive moisture, rain, sand or heat sources caused by heating equipment or direct sunlight.
- No naked flame sources, such as lighted candles, should be placed on the apparatus.
- No objects filled with liquids, such as vases, shall be placed on the apparatus.
- Don't expose the system to dripping or splashing.
- Install this unit near the AC outlet and where the AC power plug can be reached easily.
- The lens may cloud over when the system is suddenly moved from cold to warm surroundings, making it impossible to play a disc. Leave the system in the warm environment until the moisture evaporates.
- The mechanical parts of the set contain self-lubricating bearings and must not be oiled or lubricated.
- Batteries (battery pack or batteries installed) shall not be exposed to excessive heat such as sunshine, fire or the like.
- **When the system is switched to Standby mode, it is still consuming some power. To disconnect the system from the power supply completely, remove the AC power plug from the wall socket.**

# Preparations

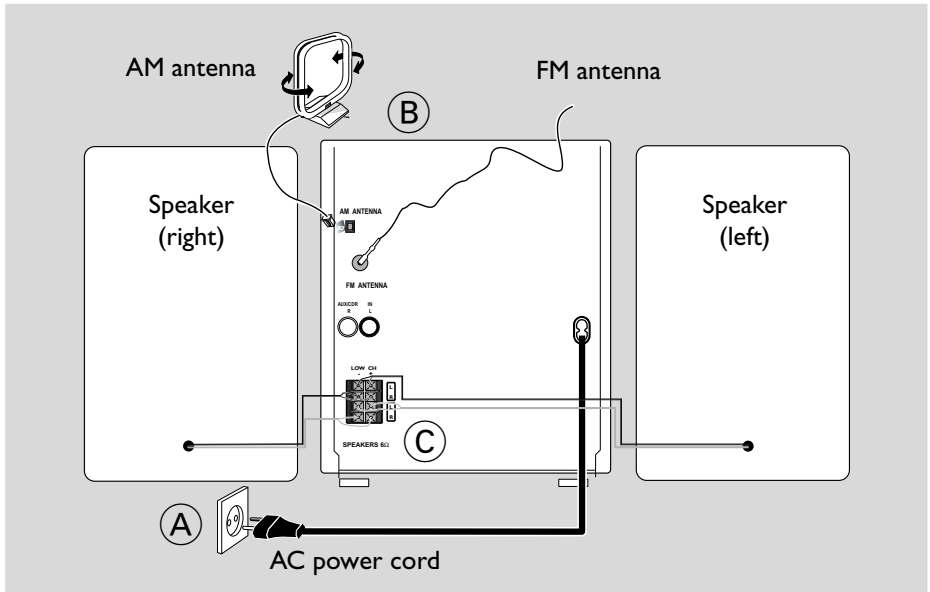

## Rear connections

The type plate is located at the rear of the system.

### A Power

Before connecting the AC power cord to the wall outlet, ensure that all other connections have been made.

If your system is equipped with a Voltage Selector, set the VOLTAGE SELECTOR to the local power line voltage.

#### WARNING!

- For optimal performance, use only the original power cable.
- Never make or change any connections with the power switched on.
- High voltage! Do not open. You run the risk of getting an electric shock.
- The machine does not contain any user-serviceable parts.
- Modification of the product could result in hazardous radiation of EMC or other unsafe operation.

To avoid overheating of the system, a safety circuit has been built in. Therefore, your system may switch to Standby mode

automatically under extreme conditions. If this happens, let the system cool down before reusing it (not available for all versions).

### B Antennas Connection

Connect the supplied AM loop antenna to the AM ANTENNA terminal. Adjust the position of the antenna for optimal reception.

### AM Antenna

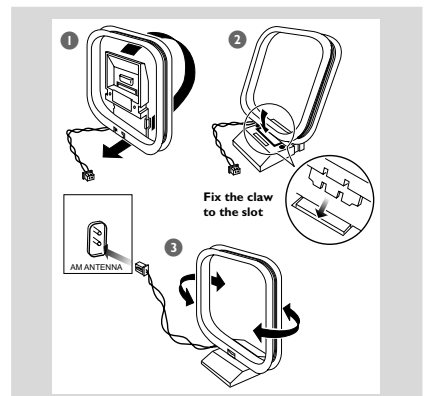

- Position the antenna as far as possible from a TV, VCR or other radiation source.



## FM Antenna

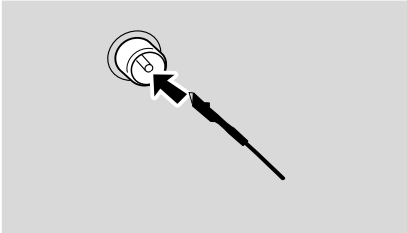

- For better FM stereo reception, connect an outdoor FM antenna to the FM ANTENNA terminal.

## C Speakers Connection

### Front Speakers

Connect the speaker wires to the SPEAKERS terminals, right speaker to "R" and left speaker to "L". red wires to "+" and black wires to "-" of the woofer connection terminals, blue wires to "+" and black wires to "-" of the tweeter connection terminals.

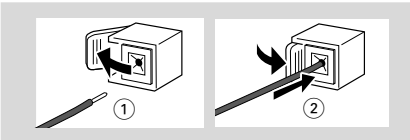

- Fully insert the stripped portion of the speaker wire into the terminal as shown.

### Notes:

- For optimal sound performance, use the supplied speakers.
- Do not connect more than one speaker to any one pair of + / - speaker terminals.
- Do not connect speakers with an impedance lower than the speakers supplied. Please refer to the SPECIFICATIONS section of this manual.

## Optional connection

The optional equipment and connecting cords are not supplied. Refer to the operating instructions of the connected equipment for details.

### Connecting a USB device or memory card

By connecting a USB mass storage device (including USB flash memory, USB flash players or memory cards) to the Hi-Fi system, you can enjoy the device's stored music through the powerful speakers of Hi-Fi system.

- Insert the USB device's USB plug into the  socket on the set.

OR

### for the devices with USB cables:

- 1 Insert one plug of the USB cable (not supplied) to the  socket on the set.
- 2 Insert the other plug of the USB cable to the USB output terminal of the USB device.

OR

### for the memory card:

- 1 Insert the memory card into a card reader (not supplied).
- 2 Use a USB cable (not supplied) to connect the card reader into the  socket on the set.

### Connecting other equipment to your system

#### Using AUX IN (white/red jacks)

- Use the audio cables (white/red, not supplied) to connect **AUX IN (L/R)** jacks of the main unit (located on the back panel) to the corresponding AUDIO OUT jacks on an external device (such as TV or VCR).

### Note:

- If you are connecting equipment with a mono output (a single audio out terminal), connect it to the AUX left terminal. Alternatively, you can use a "single to double" cinch cable (the output sound still remain mono).

# Preparations

## Using MP3 LINK (3.5 mm jack )

- Use a MP3 link cable (supplied) to connect **MP3 LINK** jack of the main unit (3.5 mm, located on the front panel) to an **AUDIO OUT** or headphone jack on an external equipment (such as CD player, or VCR).

## Inserting batteries into the remote control

Insert two batteries (Type R03 or AAA, supplied) into the remote control with the correct polarity as indicated by the "+" and "-" symbols inside the battery compartment.

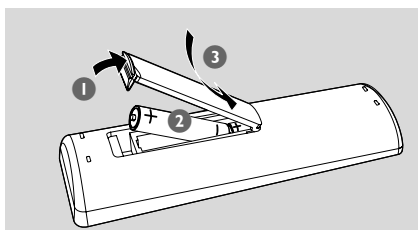

### **CAUTION!**

- **Remove batteries if they are exhausted or will not be used for a long time.**
- **Do not use old and new or different types of batteries in combination.**
- **Batteries contain chemical substances, so they should be disposed of properly.**

## Controls on the system

### ① Disc tray

### ② Display screen

- to view the current status of the system.

### ③ Mode Selection

#### ALBUM/PRESET +/-

for MP3-CD ..... to select previous/next album.

for Tuner ..... to select a preset radio station

for Clock/Timer ..... to set the hour.

for Clock ..... switches between 12 hour and 24 hour display.



for CD/ MP3-CD .. to stop playback or to clear a programme.

for Clock ..... to exit clock setting.

#### ▶ II

for CD/ MP3-CD .. to start or interrupt playback.



for MP3-CD ..... to select previous/next title.

for CD ..... to skip to the beginning of the current, previous, or next track.

for CD/ MP3-CD .. (press and hold) to search backward/forward.

for Tuner ..... tunes to radio stations.

for Clock/Timer ..... to set the minute.

### ④ MODE

- to select various repeat modes or the shuffle play mode for a disc.

### ⑤ DISPLAY

- to select disc information display mode.

### ⑥

- switches the system on or to standby mode.

### ⑦ Source selection – to select the following:

#### DISC

- to select disc tray 1, 2 or 3.

#### TUNER

- to select waveband: FM or AM.

#### USB

- to select USB source.

#### AUX/MP3 LINK

- to select the input for an additional appliance: AUX.
- to select the input for an additional appliance: MP3 LINK.

### ⑧ DBB/IS (Incredible Surround)

- to select the desired bass boost level. (DBB 1, DBB 2, DBB 3 or DBB OFF).
- to activate or deactivate the surround sound effect.

### ⑨ USB RECORD

- copies music to an external portable USB storage device.

### ⑩ USB DELETE

- deletes music stored on the external USB device.

### ⑪ USB DIRECT

- jack for the external USB mass storage device.

### ⑫ MP3 LINK jack

- Connects an external device.

### ⑬ MAX SOUND

- to activate or deactivate the optimal mix of various sound features.

### ⑭ MCIVOL 2

- to adjust the mixing level for Karaoke

### ⑮ MIC 1/2

- to connect microphone

### ⑯ DSC

- Selects different types of preset sound equaliser settings (OPTIMAL, TECHNO, ROCK or JAZZ).

### ⑰ MICVOL 1

- to adjust the mixing level for Karaoke

### ⑱ VAC

- to select different type of ambience-based equaliser settings (HALL, CONCERT or CINEMA).

### ⑲ VOLUME

- to increase or decrease the volume.

### ⑳ PROG

for CD/ MP3-CD .. to programme disc tracks.

for Tuner ..... to programme preset radio stations.

### ㉑ DISC 1/2/3

- to select a disc tray for playback.

### ㉒ OPEN•CLOSE

- to open or close the disc tray.

### ㉓ DISC CHANGE

- to change disc(s).

### ㉔ CLOCK/TIMER

- to view or set the clock.
- to set the timer

### ㉕ iR

- infrared sensor for remote control.

# Controls

## Controls on remote control

① 

- switches the system on or to standby mode.

② **Source selection** – to select the following:

**CD 1/2/3**

- to select disc tray 1, 2 or 3.

**TUNER**

- to select waveband: FM or AM.

**AUX**

- to select the input for an additional appliance: AUX or MP3 LINK.

**USB**

- to select USB source.

③ **CLOCK**

- to view or set the clock.

④ **MODE**

- selects different play modes: e.g. REPEAT or SHUFFLE (random order).

⑤ **USB DELETE**

- deletes music stored on the external USB device.

⑥ **Mode Selection**

**ALBUM - / + (◀ / ▶)**

for MP3-CD/USB/WMA

..... to select previous/next album.

for CD/MP3-CD/USB/WMA

..... (press and hold) to search backward/forward.

for Tuner ..... to tune to a lower or higher radio frequency.

for Clock/Timer .... to set the hour.

for Clock ..... switches between 12 hour and 24 hour display.

**TITLE - / + (◀ / ▶)**

for MP3-CD/WMA

..... to select previous/next title.

for CD ..... to skip to the beginning of the current, previous, or next track.

for Tuner ..... to select a preset radio station.

for Clock ..... to set the minute.

⑦ **DSC**

- Selects different types of preset sound equaliser settings (OPTIMAL, TECHNO, ROCK or JAZZ).

⑧ **MAX**

- to activate or deactivate the optimal mix of various sound features.

⑨ **VOL +/-**

- to increase or decrease the volume.

⑩ **DBB**

- to select the desired bass boost level. (DBB 1, DBB 2, DBB 3 or DBB OFF).

⑪ **Numeric Keypad (0-9)**

- to input a track number of the disc.

⑫ **PROGRAM**

for CD/ MP3-CD .. to programme disc tracks.  
for Tuner ..... to programme preset radio stations.

⑬ **DISPLAY**

- to select disc information display mode.

⑭ **■**

for CD/ MP3-CD/WMA

..... to stop playback or to clear a programme.

for Tuner ..... to stop programming.

for Clock ..... to exit clock setting.

for Plug&Play ..... to exit plug&play mode.

**▶ ||**

for CD/ MP3-CD/WMA

..... to start or interrupt playback.

⑮ **VAC**

- to select different type of ambience-based equaliser settings (HALL, CONCERT or CINEMA).

⑯ **USB RECORD**

- copies music to an external portable USB storage device.

⑰ **MUTE**

- mutes or restores the volume.

⑱ **SLEEP (TIMER)**

- to activate/deactivate or set the sleep/ wake-up timer.

⑲ **DIM**

- to turn on/off DIM function.

**Notes for remote control:**

- **First, select the source you wish to control by pressing one of the source select keys on the remote control (CD 1/2/3 or TUNER, for example).**
- **Then select the desired function (▶ ||, ◀, ▶, for example).**

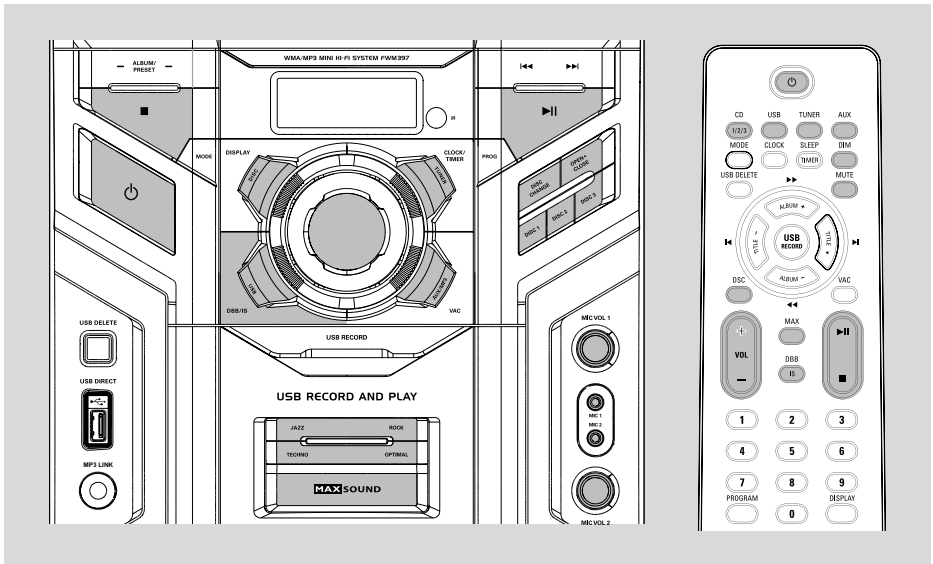

## IMPORTANT!

Before you operate the system, complete the preparation procedures.

### Plug and Play (for tuner installation)

Plug and Play allows you to store all available radio stations automatically.

#### First time setup/power up

- 1 When you turn on the main supply, "AUTO INSTALL - PRESS PLAY" is displayed.
- 2 Press ►|| to start installation.  
→ "PLUG AND PLAY" .... "INSTALL" is displayed, followed by "AUTO".  
→ All available radio stations with sufficient signal strength will be stored automatically, starting from FM and followed by AM band.  
→ When all the available radio stations are stored or the memory for 40 presets are used, the first preset radio station will be played.

#### To reinstall Plug and Play

- 1 In standby mode, press and hold ►|| until "AUTO INSTALL - PRESS PLAY" is displayed.
- 2 Press ►|| again to start installation.  
→ All previously stored radio stations will be replaced.

#### To exit without storing the Plug and Play

- Press ■.  
→ If you do not complete the Plug and Play installation, the function will be restarted when you next turn on the main supply again.

#### Notes:

- When the power is turned on, the disc tray may open and close to initialise the system.
- If no stereo frequency is detected during Plug and Play, "CHECK ANTENNA" will be displayed.
- During Plug and Play, if no button is pressed within 15 seconds, the system will exit Plug and Play mode.

### Switching the system on

- Press ⏻.  
→ The system will switch to the last selected source.
- Press DISC (or DISC 1/2/3, CD 1/2/3), TUNER, AUX/MP3 LINK (or AUX) or USB.  
→ The system will switch to the selected source.
- Press OPEN•CLOSE or DISC CHANGE.  
→ The system will switch to the disc source and the disc tray will open.

## Switching the system to standby mode

### In any other source mode

- Press **⏻**.  
→ The clock will appear on the display when the system is in standby mode.

## Power-saving automatic standby

As a power-saving feature, the system will automatically switch to Standby mode if you do not press any buttons within 15 minutes after a disc/USB has stopped playing.

## Dim mode

You can turn on or off brightness for the display.

- Press **DIM** on the remote control repeatedly to turn on or off DIM function.

## Volume control

Adjust **VOLUME** to increase (turn knob clockwise or press **VOL +** on the remote control) or decrease (turn knob anti-clockwise or press **VOL -** on the remote control) the sound level.

### To switch off the volume temporarily

- Press **MUTE** on the remote control.  
→ Playback will continue without sound and the **MUTE** is displayed.
- To restore the volume, press **MUTE** again or increase/decrease the volume level.

## Sound control

**For optimal sound listening, select only one of the following navigation sound controls at a time: MAX or DSC.**

### MAX Sound

MAX sound provides the best mixture of various sound features (DSC, DBB, for example).

- Press **MAX SOUND** (or **MAX** on the remote control) repeatedly.  
→ If activated, **MAX ON** is shown.  
→ If deactivated, **MAX OFF** is displayed.

### DSC (Digital Sound Control)

The DSC feature enables you to enjoy special sound effects that have preset equaliser settings, providing the best music reproduction.

- Press **DSC** to select : OPTIMAL, TECHNO, ROCK or JAZZ.  
→ The selected DSC is shown.

### DBB (Dynamic Bass Boost)

There are three DBB settings to enhance the bass response.

- Press **DBB/IS** to select : DBB 1, DBB 2, DBB 3 or DBB OFF.  
→ The selected **DBB** is shown, except for DBB OFF mode.

### Note:

– *Some discs might be recorded in high modulation, which causes a distortion at high volume. If this occurs, switch off DBB or reduce the volume.*

## Automatic DSC-DBB selection

The best DBB setting is generated automatically for each DSC selection. You can manually select the DBB setting that best suits your listening environment.

DSC	DBB
JAZZ	off
ROCK	on (2)
TECHNO	on (3)
OPTIMAL	on (1)

## Incredible Surround

The Incredible Surround magnifies the virtual distance between the front speakers for an incredibly wide, enveloping, stereo effect.

- Press and hold **DBB/IS**.
  - If activated, "IS ON" is displayed.
  - If deactivated, "IS OFF" is displayed.

## Karaoke

Connect a microphone (not supplied) to the system allowing you to sing along with the music source.

- 1 Connect a microphone to the **MIC 1/2** jack.
- Before connecting the microphone, set the microphone **MICVOL1** or **MICVOL2** to the minimum level to prevent howling sound.
- 2 Press **DISC** (or **DISC 1/2/3**, **CD 1/2/3**), **TUNER, AUX/MP3 LINK** (or **AUX**) or **USB** to select the source to be mixed and start playback.
- 3 Adjust the volume level of the source with **VOLUME** control.
- 4 Adjust the microphone volume with the microphone **MICVOL1** or **MICVOL2** control.

### Note:

- *Keep the microphone away from the speakers to prevent howling.*

# CD/MP3-CD/WMA Operations

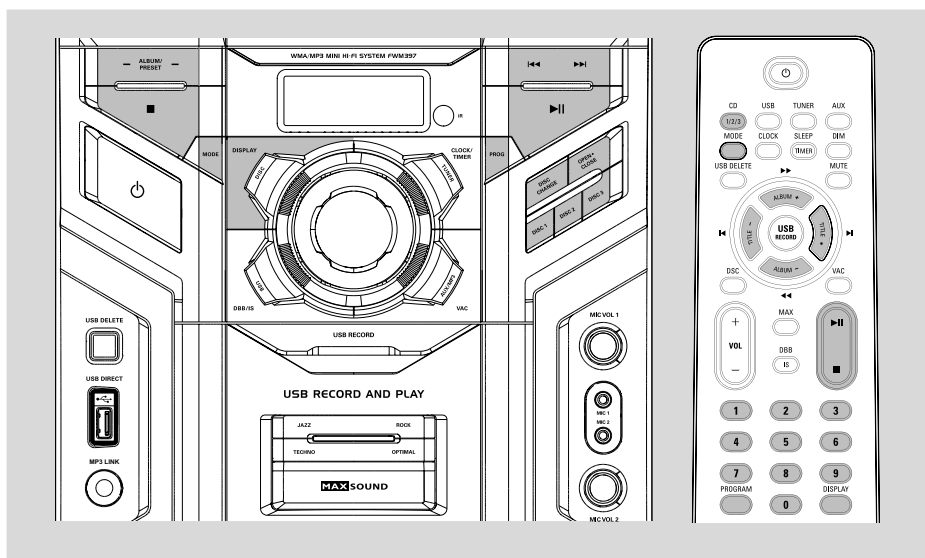

## IMPORTANT!

- This system is designed for regular discs. Therefore, do not use any accessories such as disc stabiliser rings or disc treatment sheets, etc., as offered on the market, because they may jam the changer mechanism.
- Do not load more than one disc into each tray.

## Discs for playback

This system can playback all digital audio CD, finalised digital audio CD-Recordable (CDR) discs and finalised digital audio CD-Rewritable (CDRW) discs.

MP3-CDs/WMA (CD-ROMs with MP3/WMA tracks)

\* DRM-protected WMA is not supported.



## About MP3 disc

### Supported formats

- ISO9660, Joliet, Multisession
- Number of albums/ folders: maximum 99
- Number of tracks/titles: maximum 999
- The max. MP3 program track number is 40
- Supported VBR bit-rate
- Supported sampling frequencies for MP3 disc are: 32 kHz, 44.1 kHz, 48 kHz
- Supported Bit-rates of MP3 disc are: 32, 64, 96, 128, 192, 256 (kbps)

## Loading discs

- 1 Press **OPEN•CLOSE** to open the disc tray.
- 2 Load up to two discs on the individual disc trays. To load the third disc, press **DISC CHANGE**. → The disc tray will rotate until the empty tray is ready for loading.

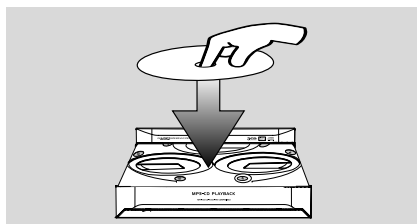



- 3 Press **OPEN•CLOSE** to close the disc tray.  
→ **READING** is displayed as the CD player scans the contents of a disc, and then the total number of tracks and playing time (or the total number of albums and tracks for MP3/WMA disc) are shown.

**Notes:**

- Load the discs with the label side facing up.
- To ensure good system performance, wait until the disc tray completely reads the disc(s) before proceeding.
- For MP3/WMA disc, the disc reading time may exceed 10 seconds due to the large number of songs compiled into one disc.

## Playing discs

### To play current disc on the disc tray

- Press **▶ II**.  
→ All loaded discs will play once, then stop.  
→ During playback, the selected disc tray, track number and elapsed playing time of the current track are displayed.  
→ For mixed mode discs, only one mode will be selected for playback depending on the recording format.

**Note:**

- When playing a mixed mode disc, you may find a very short mute track inserted into the total number of tracks available in your disc.

### To play the selected disc only

- In CD mode, press **DISC 1/2/3** (or **CD 1/2/3** on the remote control).  
→ The current disc will play once, then stop.

### To interrupt playback

- Press **▶ II**.  
→ The display freezes and the elapsed playing time flashes when playback is interrupted.
- To resume playback, press **▶ II** again.

### To stop playback

- Press **■**.

## Text display during playback

### In CD mode

- Press **DISPLAY** to show the current track number and remaining playback time.

### In MP3-CD/WMA mode

- Press **DISPLAY** repeatedly to show the current album and track numbers followed by ID3 information (if available).

## Replacing discs during playback

- 1 Press **DISC CHANGE**.  
→ The disc tray will open without interrupting current playback.
- 2 To change the inner disc, press **DISC CHANGE** again.  
→ "OPEN" is displayed and the disc will stop playing.  
→ The disc tray will close to retrieve the inner disc, then reopen with the inner disc accessible.

## Selecting a desired track/passage

### To search for a particular passage during playback

- Press and hold **◀◀ / ▶▶** (or **ALBUM +/- (◀◀ / ▶▶)** on the remote control) and release it when the desired passage is located.  
→ During searching, the volume will be muted.

### To select a desired track

- Press **◀◀ / ▶▶** (or **TITLE +/- (◀ / ▶)** on the remote control) repeatedly until the desired track is displayed.
- If playback is stopped, press **▶ II** to start playback.

## Selecting a desired Album/Title (MP3/WMA disc only)

### To select a desired album

- Press **ALBUM/PRESET +/-** (or **ALBUM +/- (◀◀ / ▶▶)** on the remote control) repeatedly.





### To select a desired title





- Press **◀◀ / ▶▶** (or **TITLE +/- (◀ / ▶)** on the remote control) repeatedly.

# CD/MP3-CD/WMA Operations

## Different play modes: SHUFFLE and REPEAT









You can select and change the various play modes before or during playback. The REPEAT modes can also be combined with PROGRAM.



-  ..... plays the current track continuously
-  **ALL** ..... repeats the entire disc/programme
-   **ALL** ..... repeats the entire disc continuously in random order
-  ..... tracks of the entire disc are played in random order

- 1 To select your play mode, press the **MODE** button before or during playback until the display shows the desired function.
- 2 Press  to start playback if in the STOP position.  
→ If you have selected SHUFFLE, playback starts automatically.
- 3 To return to normal playback, press the **MODE** button until  or  is no longer displayed.
- You can also press  to cancel your play mode.

## Programming the disc tracks

Programming tracks is possible when playback is stopped. Up to 40 tracks can be stored in the memory in any order.





- 1 Load the desired discs on the disc tray (refer to "Loading discs").
- 2 Press **DISC 1/2/3** (or **CD 1/2/3** on the remote control) to select a disc.
- 3 In stop mode, press **PROG** (or **PROGRAM** on the remote control) to start programming.  
→ **PROG** starts flashing.
- 4 Press  /  (or **TITLE +/-** ( / )) on the remote control) repeatedly to select the desired track.
- For MP3/WMA disc, press **ALBUM/PRESTE -/+** (or **ALBUM +/-** ( / )) on the remote control) and  /  (or **TITLE +/-** ( / )) on the remote control) to select the desired album and title for programming.
- 5 Press **PROG** (or **PROGRAM** on the remote control) to store the track.

- 6 To end programming, press  **once**.  
→ **PROG** stays and the programme mode remains active.
- 7 To start programme play, press .

Notes:

- It is not possible to create a programme with MP3 tracks from multiple CDs, or combined with normal audio tracks.
- If you attempt to programme more than 40 tracks, "PROGRAM FULL" is displayed.
- During programming, if no button is pressed within 90 seconds, the system will exit the programme mode automatically.

## To review the programme

- Stop playback and press  /  (or **TITLE +/-** ( / )) on the remote control) repeatedly.
- To exit review mode, press .

## Erasing the programme

- Press  **once** when playback is stopped or **twice** during playback.  
→ **PROG** disappears and "PROGRAMME CLEAR" is displayed.

Note:

- The programme will be erased when the system is disconnected from the power supply or when the disc tray is opened.

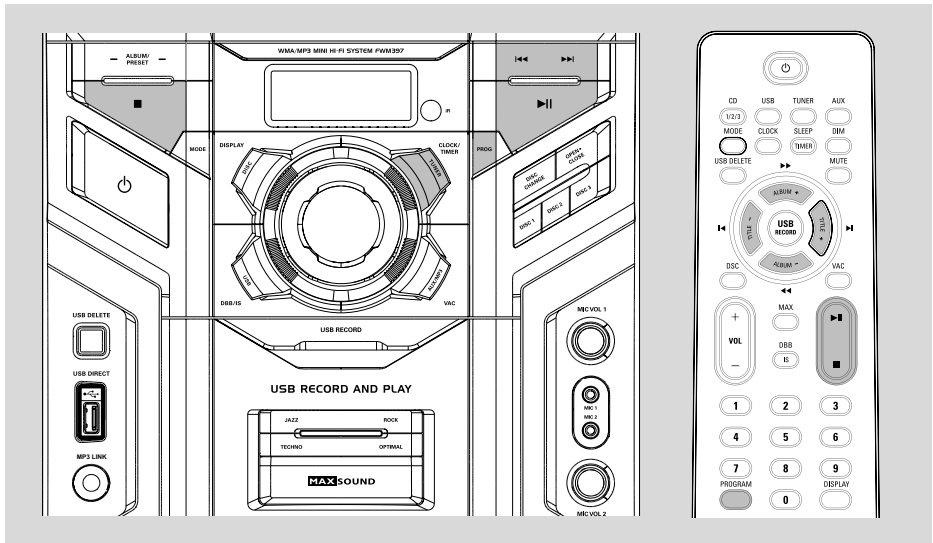

## Tuning to radio stations

- 1 Press **TUNER**.  
→ "FM" or "AM" is displayed. A few seconds later, the current radio frequency will appear on the display.
- 2 Press **TUNER** again to select the desired waveband: FM or AM.
- 3 Hold **◀◀ / ▶▶** (or **ALBUM +/- (◀◀ / ▶▶)** on the remote control) and then release the button.  
→ The system will start searching for a radio station with sufficient signal strength.
- 4 Repeat step 3 if necessary until you find the desired station.
- To tune to a weak station, press **◀◀ / ▶▶** (or **ALBUM +/- (◀◀ / ▶▶)** on the remote control) briefly and repeatedly until you have found optimal reception.

## Programming radio stations

You can store up to a total of 40 radio stations in the memory.

### Automatic programming

- 1 Press **TUNER** to select TUNER mode.
- 2 Press and hold **PROG** (or **PROGRAM** on the remote control) until "AUTO" is displayed.  
→ **PROG** starts flashing.  
→ **AUTO** is displayed and available stations are programmed in order of waveband reception strength.  
→ When all the available radio stations are stored or the memory for 40 presets are used, the first preset radio station will be played.

### To stop storing the automatic preset

- Press **■**.

### Manual programming

- 1 Tune to your desired radio station (refer to "Tuning to radio stations").
- 2 Press **PROG** (or **PROGRAM** on the remote control).  
→ **PROG** starts flashing.  
→ The next available preset number is displayed for selection.

# Radio Reception

## To store the radio station to another preset number

- Press **ALBUM/PRESET +/-** (or **TITLE +/- (◀/▶)**) on the remote control) to select the desired preset number.
- ③ Press **PROG** (or **PROGRAM** on the remote control) again to store the radio station.  
→ **PROG** disappears.
- Repeat **steps 1–3** to store other radio stations.

## To exit manual preset mode

- Press **■**.

### Notes:

- If you attempt to store more than 40 preset radio stations, "PROGRAM FULL" is displayed.
- During programming, if no key is pressed within 90 seconds, the system will exit the programme mode automatically.

## Tuning to preset radio stations

- Press **ALBUM/PRESET +/-** (or **TITLE +/- (◀ / ▶)**) on the remote control) until the desired preset station is displayed.

## Using a USB mass storage device

By connecting a USB mass storage device or SD/MMC memory card to the Hi-Fi system, you can enjoy the device's or card's stored music through the powerful speakers of Hi-Fi system.

### Playing a USB mass storage device

#### Compatible mass storage devices/cards

With the Hi-Fi system, you can use:

- USB flash memory (USB 2.0 or USB1.1)
- USB flash players (USB 2.0 or USB1.1)
- memory cards (requires an additional card reader to work with this Hi-Fi system)

#### Notes:

- *In some USB flash players (or memory devices), the stored contents are recorded using copyright protection technology. Such protected contents will be unplayable on any other devices (such as this Hi-Fi system).*
- *Compatibility of the USB connection on this product:*
  - a) *This product supports most USB Mass storage devices (MSD) that are compliant to the USB MSD standards.*
    - i) *Most common Mass storage class devices are flash drives, memory sticks, jump drives and etc.*
    - ii) *If you see a "Disc Drive" show up on your computer after you plugged the mass storage device into your computer, most likely it is MSD compliant and it will work with this product.*
  - b) *If your Mass storage device required a battery/ power source. Please make sure you have a fresh battery in it or charge the USB device first and then plug it into the product again.*
- *Supported Music type:*
  - a) *This device only supports unprotected music with the following file extension:*  
.mp3  
.wma
  - b) *Music bought from on-line music stores are not supported because they are secured by Digital Rights Management protection (DRM).*
  - c) *File name extensions that end with the following are not supported:*  
.wav; .m4a; .m4p; .mp4; .aac and etc.
- *No Direct connection can be made from Computer USB port to the product even you have either or both mp3 or wma files in your computer.*

#### Supported formats:

- USB or memory file format FAT12, FAT16, FAT32 (sector size: 512 bytes)
- MP3 bit rate (data rate): 32-320 Kbps and variable bit rate
- WMA v9 or earlier
- Directory nesting up to a maximum of 8 levels
- Number of albums/ folders: maximum 99
- Number of tracks/titles: maximum 999
- ID3 tag v2.0 or later
- File name in Unicode UTF8 (maximum length: 128 bytes)

#### The system will not play or support the following:

- Empty albums: an empty album is an album that does not contain MP3/WMA files, and will not be shown in the display.
- Non-supported file formats are skipped. This means that e.g.: Word documents .doc or MP3 files with extension .dlf are ignored and will not be played.
- AAC, WAV, PCM audio files
- DRM protected WMA files
- WMA files in Lossless format

## How to transfer music files from PC to a USB mass storage device

By dragging and dropping music files, you can easily transfer your favorite music from PC to a USB mass storage device/SD/MMC memory card.

For a flash player, you can also use its music management software for the music transfer.

**However, those WMA files may be unplayable for compatibility reasons.**

## How to organize your MP3/WMA files on the USB mass storage device/SD/MMC memory card

This Hi-Fi system will browse the MP3/WMA files in the folders/sub-folders/titles order.

Example:

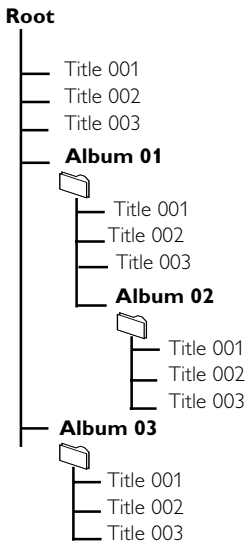

Organize your MP3/WMA files in different folders or subfolders as required.

Notes:

- If you have not organized MP3/WMA files into any albums on your disc, an album "01" will be automatically assigned for all those files.
- Make sure that the file names of MP3 files end with .mp3, and the file names of WMA files end with .wma.
- For DRM protected WMA files, use Windows Media Player 10 (or later) for conversion. Visit [www.microsoft.com](http://www.microsoft.com) for details about Windows Media Player and WM DRM (Windows Media Digital Rights Management).

- 1 Check the USB device has been properly connected. (See Installation: Connecting an additional appliance).
- 2 Press **USB** to select USB.
  - **NO SONGS** appears if no audio file is found in the USB device.
- 3 Play the USB's audio files as you do with the albums/tracks on a CD (See CD/MP3 Operations).

Notes:

- For compatibility reasons, the album/track information may differ from what it is displayed through flash players' music management software.
- File names or ID3 tags will be displayed as — if they are not in English.

## Ripping function

This function enables you to record music to a connected USB mass storage device from any other source (i.e., DISC, TUNER or AUX) without interrupting your enjoyment of the music.

- 1 Insert a USB mass device with sufficient free space to the **USB DIRECT**  socket on the set. (See "Installation: Connecting an additional appliance").
- 2 Prepare the source to record from.
 

**DISC** - load the disc(s). Select the disc to record from. Then, select a track where ripping will start (See "CD/MP3-CD Operations": "Selecting a desired track/passage" and "Selecting a desired Album/Title (MP3/WMA disc only)").

**TUNER** - tune to the desired radio station (See "Radio Reception": "Tuning to radio stations" and "Tuning to preset radio stations").

**AUX** - connect external equipment.
- 3 Press **USB RECORD** to start ripping.
  - "USB REC" will start flashing on the display.
  - In the DISC mode, "RIPPING ONE" will scroll once.
- In the DISC mode, to record all tracks starting from the one you selected, press USB RECORD again.
  - "RIPPING ALL" will scroll once. "ALL" and "USB REC" will start flashing on the display.
- 4 At any moment, simply press **■** to stop ripping.

Notes:

- This function can also be combined with the *programme function*. In this case, selection of "RIPPING ALL" in DISC mode will record all programmed tracks from the starting point to the USB mass storage device.
- It is impossible to rip from "MIC IN".
- Never unplug the USB mass storage device before pressing **■** to stop ripping.
- In the DISC mode, when you stop ripping or the free space is insufficient, the current track being ripped will not be recorded to your USB mass storage device and the playback will stop at the same time.
- During ripping, it is impossible to select any other source or track (radio station) or even switch the set to standby mode.

## To delete a track/album from your USB mass storage device

- 1 Plug in the USB mass storage device.
- 2 Select the track to be deleted during playback.
- 3 Press **USB DELETE**.
  - "DELETE TRACK-- PRESS AGAIN TO DELETE " appears.
- 4 Press **USB DELETE** again before "DELETE TRACK-- PRESS AGAIN TO DELETE" disappears to confirm the deletion.

## Tuner record timer setting

This function enables you to set a timer for starting and stopping ripping from the tuner source automatically.

### IMPORTANT!

– Before setting the timer, ensure that the clock is set correctly.

- 1 Tune to the station you desire to record from. (See "Radio Reception": "Tuning to radio stations" and "Tuning to preset radio stations".)
- 2 Go to the standby mode. Then, press and hold **CLOCK/TIMER (SLEEP/TIMER)** on the remote control) for more than two seconds to select timer mode.
  - The last timer setting starts flashing.
  - The selected source will be lighted.
- 3 Press **TUNER** to select TUNER mode.
- 4 Press **USB RECORD** to enable USB recording.
  - "ST" appears. "USB REC" and the hour and minute digits for the start timer start flashing.
- To cancel USB record setting, press **USB RECORD** again until "ST" and "USB REC" disappear.
  - In this case, you can only continue to set the system switch-on timer. (See "Clock/Timer": "Timer setting".)
- 5 Press **ALBUM/PRESET +/-** (or **ALBUM +/-** (◀◀ / ▶▶) on the remote control) repeatedly to set the hour for the timer to start.
- 6 Press **◀◀ / ▶▶** (or **TITLE +/-** (◀ / ▶) on the remote control) repeatedly to set the minute for the timer to start.
- 7 Press **CLOCK/TIMER** (or **SLEEP/TIMER** on the remote control) on the remote control to confirm.
  - "ET" appears. „z and the hour and minute digits for the sleep timer (12 hours later than the start timer by default) start flashing.
- 8 Press **ALBUM/PRESET +/-** (or **ALBUM +/-** (◀◀ / ▶▶) on the remote control) repeatedly to set the hour for the timer to stop.
- 9 Press **◀◀ / ▶▶** (or **TITLE +/-** (◀ / ▶) on the remote control) repeatedly to set the minute for the timer to stop.
- 10 Press **CLOCK/TIMER** (or **SLEEP / TIMER** on the remote control) to store the set tuner record timer.
  - The ripping will start at the set start time and end at the set stop time.

### Notes:

- It is impossible to set a sleep timer more than 12 hours later than the start timer.
- During timer setting, if no button is pressed within 60 seconds, the system will exit timer setting mode automatically.

### To deactivate the TIMER

- In standby mode, press **SLEEP / TIMER** on the remote control.
  -  disappears from the display.

### To activate the TIMER

- In standby mode, press **SLEEP / TIMER** on the remote control.
  -  appears on the display.



---

## Listening to external sources

### Using AUX IN (white/red jacks)

- 1 Use the audio cables (white/red, not supplied) to connect **AUX IN (L/R)** jacks of the main unit (located on the back panel ) to the corresponding AUDIO OUT jacks on an external device (such as TV or VCR).
- 2 Press **AUX/MP3 LINK** (or **AUX** on the remote control) repeatedly until "AUX " is displayed.

### Using MP3 LINK (3.5 mm jack )

- 1 Use a MP3 link cable (supplied) to connect **MP3 LINK** jack of the main unit (3.5 mm, located on the front panel) to an AUDIO OUT or headphone jack on an external equipment (such as CD player, or VCR).
- 2 Press **AUX/MP3 LINK** (or **AUX** on the remote control) repeatedly until "MP3 LINK" is displayed.

#### Note:

- All the sound control features (DSC or DBB, for example) are available for selection.
- Refer to the operating instructions for the connected equipment for details.

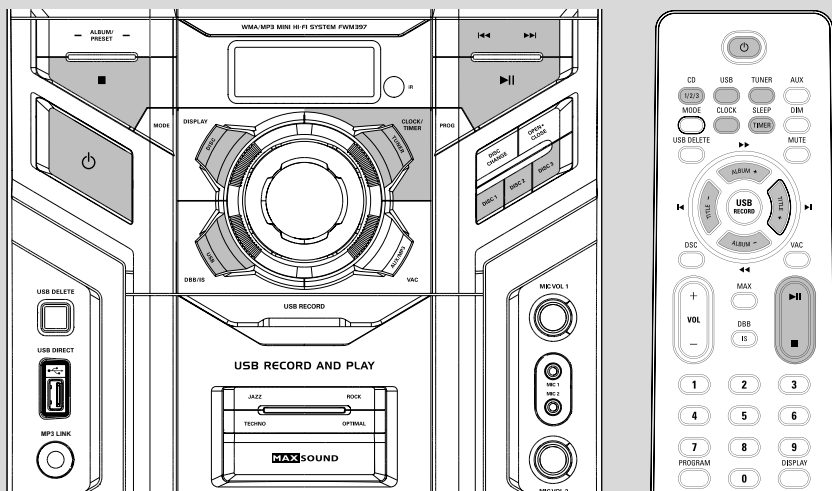

## Clock setting

The clock can be set in either 12-hour or 24-hour mode ("PM 12:00" or "00:00" for example).

- 1 In standby or view clock mode, press **CLOCK/TIMER** (or **CLOCK** on the remote control).
- 2 Press **ALBUM/PRESET +/-** (or **ALBUM +/-** (◀/▶) on the remote control) to select clock mode.
- 3 Press **CLOCK/TIMER** (or **CLOCK** on the remote control) to activate to adjust clock time.
- 4 Press **ALBUM/PRESET +/-** (or **ALBUM +/-** (◀/▶) on the remote control) repeatedly to set the hour.
- 5 Press **◀◀/▶▶** (or **TITLE +/-** (◀/▶) on the remote control) repeatedly to set the minute.
- 6 Press **CLOCK/TIMER** (or **CLOCK** on the remote control) again to store the setting.  
→ The clock starts working.

### To exit without storing the setting

- Press **■**.

### Notes:

- The clock setting will be cancelled when the power cord is disconnected or if a power failure occurs.
- During clock setting, if no button is pressed within 30 seconds, the system will exit clock setting mode automatically.

## Timer setting

The system can switch on to DISC, TUNER or USB mode automatically at a preset time, serving as an alarm to wake you up.

### IMPORTANT!

– Before setting the timer, ensure that the clock is set correctly.

- 1 In standby or view clock mode, press and hold **CLOCK/TIMER** (or **SLEEP/TIMER** on the remote control) on the remote control for more than **two seconds** to select timer mode.  
→ The last timer setting starts flashing.  
→ The selected source will be lighted.
- 2 Press **DISC** (or **DISC 1/2/3**, **CD 1/2/3**), **TUNER** or **USB** to select the desired source.
  - Before setting timer, make sure the music source has been prepared.
    - CD** – Load the disc(s).
    - TUNER** – tune to the desired radio station.
- 3 Press **CLOCK/TIMER** (or **SLEEP/TIMER** on the remote control) to activate to adjust time.
- 4 Press **ALBUM/PRESET +/-** (or **ALBUM +/-** (◀/▶) on the remote control) repeatedly to set the hour for the timer to start.

- 5 Press **⏮ / ⏭** (or **TITLE +/- (⏮ / ⏭)**) on the remote control ) repeatedly to set the minute for the timer to start.
- 6 Press **CLOCK/TIMER** (or **SLEEP/TIMER** on the remote control ) to store the start time.
- At the preset time, the selected source will play.

### To exit without storing the setting

- Press **■** on the system.

#### Notes:

- When the preset time is reached and the selected disc tray is empty, the next available disc will be selected. If all the disc trays are not available, Tuner will be selected automatically.
- During timer setting, if no button is pressed within 60 seconds, the system will exit timer setting mode automatically.

### To deactivate the TIMER

- In standby or view clock mode, press **SLEEP/TIMER** on the remote control.
-  disappears from the display.

### To activate the TIMER

- In standby or view clock mode, press **SLEEP/TIMER** on the remote control.
-  appears on the display.

## Sleep timer setting

The sleep timer enables the system to switch to standby mode automatically at a preset time.

- 1 In active mode, press **SLEEP/TIMER** on the remote control repeatedly to select a preset time.
  - The selections are as follows (time in minutes):  
90 → 75 → 60 → 45 → 30 → 15 → OFF → 90...
- 2 When you reach the desired length of time, stop pressing the **SLEEP/TIMER** button.
  - **ZZZ** is shown, except for "OFF" mode.
  - The sleep timer is now set.

### To check the remaining length of time after sleep timer is activated

- Press **SLEEP/TIMER** once.

### To change the preset sleep timer

- Press **SLEEP/TIMER** again while the remaining sleep timer is shown.
- The display will show the next sleep timer options.

### To deactivate the sleep timer

- Press **SLEEP/TIMER** repeatedly until "OFF" is displayed, or press **⏻**.

#### Note:

- **ZZZ** will start flashing when the remaining length of time after activation of the sleep timer is less than 1 minute.

## Cleaning the Cabinet

- Use a soft cloth slightly moistened with a mild detergent solution. Do not use a solution containing alcohol, spirits, ammonia or abrasives.

## Cleaning Discs

- When a disc becomes dirty, clean it with a cleaning cloth. Wipe the disc from the centre out.
- Do not use solvents such as benzene, thinner; commercially available cleaners, or antistatic spray intended for analogue records.

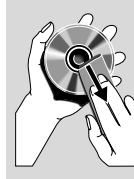

## Cleaning the disc lens

- After prolonged use, dirt or dust may accumulate at the disc lens. To ensure good playback quality, clean the disc lens with Philips CD Lens Cleaner or any commercially available cleaner. Follow the instructions supplied with cleaner.

## AMPLIFIER

RMS output power

1KHz (Low channel-both channels driven) .....  
..... 60 W per channel

10KHz (High channel-both channels driven) ....  
..... 60 W per channel

Total output power ..... 240 W

Signal-to-noise ratio ..... 67 dB A (IEC)

Frequency response ..... 60 – 16000 Hz

Input sensitivity

AUX ..... 1500mV/2000mV

Output

Speakers ..... 6  $\Omega$   
(1) (6  $\Omega$ , 1 kHz, 10%THD)

## CD/MP3-CD PLAYER

Number of programmable tracks ..... 40

Frequency response ..... 60 – 20000 Hz -3dB

Signal-to-noise ratio ..... 75 dB A

Channel separation ..... 50 dB (1 kHz)

Total harmonic distortion ..... < 1.5%

MPEG 1 Layer 3 (MP3-CD) ..... MPEG AUDIO

MP3-CD bit rate ..... 32-256 kbps  
(128 kbps advised)

Sampling frequencies ..... 32, 44.1, 48 kHz

## TUNER

FM wave range ..... 87.5 – 108 MHz

AM wave range (9 kHz) ..... 531 – 1602 kHz

AM wave range (10 kHz) ..... 530 – 1700 kHz

Tuning grid ..... 9/10 kHz

Number of presets ..... 40

Antenna

FM ..... 75  $\Omega$  wire

AM ..... Loop antenna

## USB PLAYER

USB ..... 12Mb/s,V1.1  
..... support MP3 and WMA files

Number of albums/folders ..... maximum 99

Number of tracks/titles ..... maximum 999

## SPEAKERS

System 2-way; double port bass reflex

Impedance ..... 6  $\Omega$

Woofer ..... 5.25"

Tweeter ..... 1.75"

Dimensions (w x h x d) .. 249 x 344 x 250 (mm)

Weight ..... 3.65 kg each

## GENERAL

Material/finish ..... Polystyrene/Metal

AC Power ..... 110 – 127 / 220 – 240 V;  
..... 50/60 Hz, Switchable

Power Consumption

Active ..... 100 W

Standby .....  $\leq$  15 W

Dimensions (w x h x d) .. 265 x 310 x 403 (mm)

Weight (without speakers) ..... 9.1 kg

**Specifications and external appearance are subject to change without notice.**

# Troubleshooting

## WARNING

*Under no circumstances should you try to repair the system yourself, as this will invalidate the warranty. Do not open the system as there is a risk of electric shock.*

*If a fault occurs, first check the points listed below before taking the system for repair. If you are unable to remedy a problem by following these hints, consult your dealer or Philips for help.*

Problem	Solution
<b>“NO DISC” is displayed.</b>	<ul style="list-style-type: none"><li>✓ Insert a disc.</li><li>✓ Check if the disc is inserted upside down.</li><li>✓ Wait until the moisture condensation at the lens has cleared.</li><li>✓ Replace or clean the disc, see “Maintenance”.</li><li>✓ Use a finalized CD-RW or a correct MP3-CD format disc.</li></ul>
<b>“DISC NOT FINALIZED” is displayed.</b>	<ul style="list-style-type: none"><li>✓ Use a finalised CD-RW or CD-R.</li></ul>
<b>Radio reception is poor.</b>	<ul style="list-style-type: none"><li>✓ If the signal is too weak, adjust the antenna or connect an external antenna for better reception.</li><li>✓ Increase the distance between the Mini HiFi System and your TV or VCR.</li></ul>
<b>The system does not react when buttons are pressed.</b>	<ul style="list-style-type: none"><li>✓ Remove and reconnect the AC power plug and switch on the system again.</li></ul>
<b>Sound cannot be heard or is of poor quality.</b>	<ul style="list-style-type: none"><li>✓ Adjust the volume.</li><li>✓ Check that the speakers are connected correctly.</li><li>✓ Check if the stripped speaker wire is clamped.</li><li>✓ Make sure the MP3-CD was recorded within 32-256 kbps bit rate with sampling frequencies at 48 kHz, 44.1 kHz or 32 kHz.</li></ul>
<b>The left and right sound outputs are reversed.</b>	<ul style="list-style-type: none"><li>✓ Check the speaker connections and location.</li></ul>

**The remote control does not function properly.**

- ✓ Select the source (DISC or TUN, for example) before pressing the function button (▶||, ◀, ▶).
- ✓ Reduce the distance between the remote control and the system.
- ✓ Insert the batteries with their polarities (+/- signs) aligned as indicated.
- ✓ Replace the batteries.
- ✓ Point the remote control directly towards the IR sensor.

**The time is not working.**

- ✓ Set the clock correctly.
- ✓ In standby mode, press SLEEP/TIMER on the remote control to switch on the timer.

**The Clock/Timer setting is erased.**

- ✓ Power has been interrupted or the power cord has been disconnected. Reset the clock/timer.

**Some files on the USB device are not displayed.**

- ✓ Check if the number of folders exceeds 99 or the number of titles exceeds 999.

**"DEVICE NOT SUPPORTED" scrolls on the display.**

- ✓ Remove the USB mass storage device or select another source.

Meet Philips at the Internet  
<http://www.philips.com>

Español

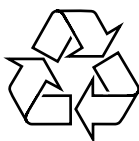

FWM397



Printed in China

PDCC-ZYL-0818