

Portable DVD player

PET740

Register your product and get support at
www.philips.com/welcome

User manual



PHILIPS

Important notes for users in the U.K.

Mains plug

This apparatus is fitted with an approved 13 Amp plug. To change a fuse in this type of plug proceed as follows:

- 1.** Remove fuse cover and fuse.
- 2.** Fix new fuse which should be a BS1362 3 Amp, A.S.T.A. or BSI approved type.
- 3.** Refit the fuse cover.

If the fitted plug is not suitable for your socket outlets, it should be cut off and an appropriate plug fitted in its place. If the mains plug contains a fuse, this should have a value of 3 Amp. If a plug without a fuse is used, the fuse at the distribution board should not be greater than 3 Amp.

Note: The severed plug must be disposed of to avoid a possible shock hazard should it be inserted into a 13 Amp socket elsewhere.

How to connect a plug

The wires in the mains lead are coloured with the following code: blue = neutral (N), brown = live (L). As these colours may not correspond with the colour markings identifying the terminals in your plug, proceed as follows:

- Connect the blue wire to the terminal marked N or coloured black.
- Connect the brown wire to the terminal marked L or coloured red.
- Do not connect either wire to the earth terminal in the plug, marked E (or e) or coloured green (or green and yellow).

Before replacing the plug cover, make certain that the cord grip is clamped over the sheath of the lead - not simply over the two wires.

Copyright in the U.K.

Recording and playback of material may require consent. See Copyright Act 1956 and The Performer's Protection Acts 1958 to 1972.

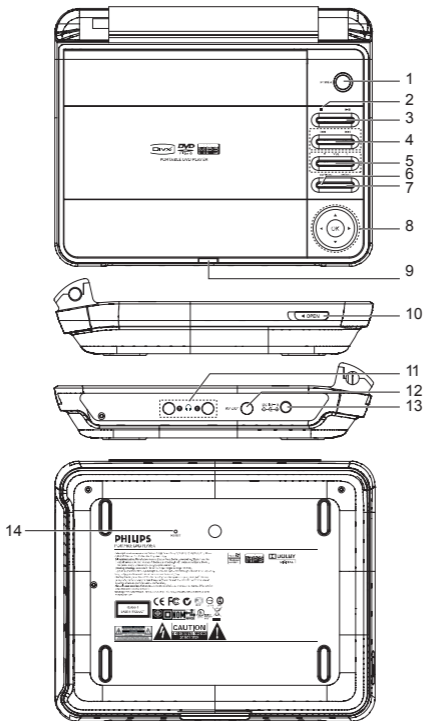
1

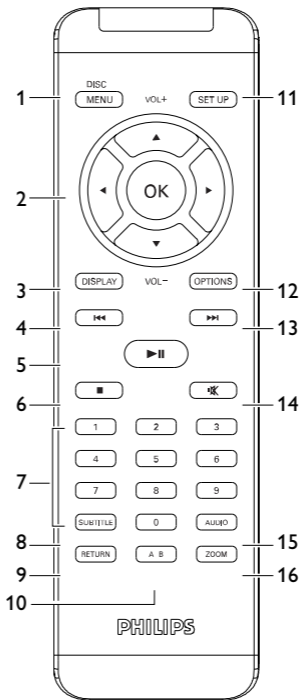

Content

1	Control elements and functional components . . .	8
1.1	Main unit controls	8
1.2	Remote Control	9
2	Introduction	10
2.1	Your portable DVD player	10
2.2	Unpacking	10
2.3	Placement	10
2.4	Playable disc formats	11
3	General information	13
4	Charging the units	17
4.1	Charge the DVD player	17
4.2	Powering your remote control	17
5	Start up	19
5.1	Setup	19
5.2	Playback DVD	20
5.3	Playback VCD	21
5.4	Playback Super (S)-VCD	22

5.5	Playback Music CD	23
5.6	Playback Music MP3-CD	24
5.7	Playback Picture-CD	25
6	Addition Functions	27
6.1	DISPLAY Menu	27
6.2	Connection	28
6.2.1	Headphone	28
6.2.2	TV	28
7	Troubleshooting	29
8	Technical data	31

Congratulations on your purchase and welcome to Philips! To fully benefit from the support that Philips offers, register your product at www.philips.com/welcome.

1 Control elements and functional components (illustrations on page 4-5)

1.1 Main unit controls (see figure 1)

- | | |
|---|---|
| 1 POWER | Switch the player on / off |
| 2 ■ | Press once to stop playback and store the stop position. Press twice to stop playback completely. |
| 3 ► | Start / pause / resume playback |
| 4 ◀◀ / ▶▶ | Skip to previous/next track or fast search backward/forward |
| 5 -VOL + | Volume control |
| 6 OPTION | Access additional functions |
| 7 MENU | Display MENU page |
| 8 ▲, ▼, ◀, ▶ | Up / down / left / right cursor |
| OK | Confirm selection |
| 9 POWER•IR•CHG | Power / Remote sensor / charging indicator |
| 10 OPEN | Open disc door to insert or remove disc |
| 11 1  2 | Headphones jacks |
| 12 AV OUT | Audio/Video output |
| 13 DC IN 12V | Power supply socket |
| 14 RESET | Reset the player when it is hanged up |

1.2 Remote Control (see figure 2)

- | | | |
|----|-------------------|--|
| 1 | MENU | Display MENU page |
| 2 | ▲, ▼, ◀, ▶ | Up / down / left / right navigation key |
| | OK | Confirm selection |
| | VOL+ / - | Volume control |
| 3 | DISPLAY | Adjust the display value of the system |
| 4 | ◀◀ | Skip to previous chapter, track or title |
| 5 | ▶▶ | Start / pause / resume playback |
| 6 | ■ | Press twice to stop playback |
| 7 | 0 - 9 | Numeric keypad |
| 8 | SUBTITLE | Subtitle language selector |
| 9 | RETURN | For VCD menu page |
| 10 | A - B | To repeat or loop a sequence in a title |
| 11 | SETUP | Enter SETUP menu |
| 12 | OPTION | Access additional functions |
| 13 | ▶▶ | Skip to next chapter, track or title |
| 14 | 🔇 | Mute player volume |
| 15 | AUDIO | Audio language selector |
| 16 | ZOOM | Enlarge video image |

2 Introduction

2.1 Your portable DVD player

Your portable DVD player plays digital video discs conforming to the universal DVD Video standard. With it, you will be able to enjoy full-length movies with true cinema picture quality, and stereo or multichannel sound (depending on the disc and on your playback set-up).

The unique features of DVD-Video, such as selection of soundtrack and subtitle languages, and of different camera angles (again depending on the disc), are all included. What's more, parental lock lets you decide which discs your children will be able to see. You will find your player remarkably easy to use with the On-Screen Display and player display in combination with the remote control.

2.2 Unpacking

First check and identify the contents of your package, as listed below:

- Portable DVD player
- Car adaptor
- AC power adaptor
- Remote Control
- User manual
- Audio/Video cable

2.3 Placement

- Place the player on a firm, flat surface.
- Keep away from domestic heating equipment and direct sunlight.
- If the player cannot read CDs/DVDs correctly, try using a commonly available cleaning CD/DVD to clean the lens before taking the player to be repaired. Other cleaning methods may destroy the lens.
- Always keep the disc door closed to avoid dust on the lens.

- The lens may cloud over when the player is suddenly moved from cold to warm surroundings. It is then not possible to play a CD/DVD. Leave the player in a warm environment until the moisture evaporates.

2.4 Playable disc formats

In addition to DVD-Video disc, you will also be able to play all Video CDs, CDs, CDR, CDRW, DVD±R and DVR±RW.

2.4.1 DVD-Video

Depending on the material on the disc (a movie, video clips, a drama series, etc.) these discs may have one or more Titles, and each Title may have one or more Chapters. To make access easy and convenient, your player lets you move between Titles, and also between Chapters.

2.4.2 Video CD

Depending on the material on the disc (a movie, video clips, a drama series, etc.) these discs may have one or more Tracks, and tracks may have one or more indexes, as indicated on the disc case. To make access easy and convenient, your player lets you move between tracks and between indexes.

2.4.3 Audio CD / MP3 CD

Audio CDs / MP3 CD contain music tracks only. You can play them in the conventional way through a stereo system using the keys on the remote control and/or main unit, or via the TV using the On Screen Display (OSD).

2.4.4 CD with JPEG files

You can also view JPEG still photos on this player.

2.4.5 DivX video discs



DivX is a popular media technology created by DivX, Inc.

DivX media files contain highly compressed video with high visual quality that maintains a relatively small file size. DivX files can also include advanced media features like menus, subtitles, and alternate audio tracks. Many DivX media files are available for download online, and you can create your own using your personal content and easy-to-use tools from DivX.com.

Official DivX® Certified product.

3 General information

Power Sources

This unit operates on a supplied AC adaptor, car adapter, or a rechargeable battery pack.

- Make sure that the input voltage of the AC adaptor is in line with the local voltage. Otherwise, the AC adaptor and unit may be damaged.
- Do not touch the AC adaptor with wet hands to prevent electric shock.
- When connecting with car power (cigarette lighter) adaptor, be sure the input voltage of the adaptor is identical with car voltage.
- Unplug the AC adaptor from the outlet when the unit is not used for long periods of time.
- Hold the plug to disconnect the AC adaptor. Do not pull the power cord.

Please always use supplied AC/DC adaptor (AY4195)

Safety and maintenance

- Do not disassemble the unit for laser rays are dangerous to eyes. Any service should be done by qualified service personnel.
- Unplug the AC adaptor to cut the power if liquid or objects get inside the unit.
- Take care not to drop the unit or subject it to strong shocks, which may cause malfunction.
- Do not expose to excessive heat caused by heating equipment or direct sunlight.
- This product is not waterproof: do not allow your player to be submersed in water. Water entering the player may cause major damage.

- Do not use any cleaning agents containing alcohol, ammonia, benzene, or abrasives as these may harm the player.
- Apparatus shall not be exposed to dripping or splashing. Do not place any sources of danger on the apparatus (e.g. liquid filled objects, lighted candles)
- Do not touch the lens!

Hearing Safety

Listen at a moderate volume.

- Using headphones at a high volume can impair your hearing. This product can produce sounds in decibel ranges that may cause hearing loss for a normal person, even for exposure less than a minute. The higher decibel ranges are offered for those that may have already experienced some hearing loss. 
- Sound can be deceiving. Over time your hearing “comfort level” adapts to higher volumes of sound. So after prolonged listening, what sounds “normal” can actually be loud and harmful to your hearing. To guard against this, set your volume to a safe level before your hearing adapts and leave it there.
- Excessive sound pressure from earphones and headphones can cause hearing loss.

To establish a safe volume level:

- Set your volume control at a low setting.
- Slowly increase the sound until you can hear it comfortably and clearly, without distortion.

Listen for reasonable periods of time:

- Prolonged exposure to sound, even at normally “safe” levels, can also cause hearing loss.
- Be sure to use your equipment reasonably and take appropriate breaks.

Be sure to observe the following guidelines when using your headphones.

- Listen at reasonable volumes for reasonable periods of time.
- Be careful not to adjust the volume as your hearing adapts.
- Do not turn up the volume so high that you can't hear what's around you.
- You should use caution or temporarily discontinue use in potentially hazardous situations.
- Do not use headphones while operating a motorized vehicle, cycling, skateboarding, etc.; it may create a traffic hazard and is illegal in many areas.
- Important (for models with by-packed headphones): Philips guarantees compliance with the maximum sound power of its audio players as determined by relevant regulatory bodies only with the original model of provided headphones. In case this one needs replacement, we recommend that you contact your retailer to order a model identical to that of the original provided by Philips.
- Traffic safety: do not use while driving or cycling as you may cause an accident.

When the player is in use for a long period of time, the surface will be heated. This is normal.

CAUTION Use of controls or adjustments or performance of procedures other than herein may result in hazardous radiation exposure or other unsafe operation.

Handling discs

- Do not attach paper or tape to the disc.
- Keep the disc away from direct sunlight or heat sources.
- Store the disc in a disc case after playback.
- To clean, wipe the disc outwards from the center with a soft, lint-free clean cloth.



On handling the LCD screen

The LCD is manufactured using high precision technology. You may, however, see tiny black points that continuously appear on the LCD. This is a normal result of the manufacturing process and does not indicate a malfunction.

Environmental information

We have reduced the packaging to its minimum and made it easy to separate into mono materials: cardboard, PS, PE and PET. Your set consists of material which can be recycled if disassembled by a specialized company. Please observe the local regulations to dispose of packaging, exhausted batteries and old equipment.

Copyright information

“DivX, DivX” Certified, and associated logos are trademarks of DivX, Inc. and are used under license.”

All other brand and product names are trademarks of their respective companies or organizations.

Unauthorized duplication of any recordings downloaded from the internet or made from CDs / VCDs / DVDs is a violation of copyright laws and international treaties.

The Windows Media and the Windows logo are registered trademarks of Microsoft Corporation in the United States and/or other countries.

4.1 Charge the DVD player

Plug in the AC/DC adaptor

- The **RED** LED indicates that charging is in progress.
- When the set is not in use, it will take about 4 hours to fully charge it.

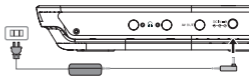

The **RED** LED will turn off when the set is fully charged.

Tips:

- * You can operate the DVD player while charging. However, it takes longer time to fully charge the battery.
- * When the low battery icon appears on the screen, please charge the player.
- * Rechargeable batteries have a limited number of charge cycles and may eventually need to be replaced. Battery life and number of charge cycles vary by use and settings.

4.2 Powering your remote control

- 1 Open the battery compartment. Remove the protective plastic tab (first time users only).
- 2 Insert 1 x lithium 3V battery, type CR2025, then close the compartment.



CAUTION

- Batteries contain chemical substances, so they should be disposed of properly.
- Batteries shall not be exposed to excessive heat such as sunshine, fire or the like.
- Danger of explosion if battery is incorrectly replaced. Replace only with the same or equivalent type.
- Incorrect use of batteries can cause electrolyte leakage and will corrode the compartment or cause the batteries to burst.
- Remove the batteries if the set is not to be used for a long time.
- Perchlorate Material – special handling may apply. See www.dtsc.ca.gov/hazardouswaste/perchlorate.

5.1 Setup

1 Press **SETUP**. A list of features is shown.

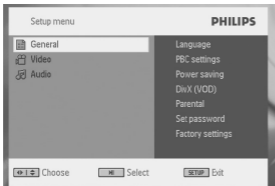

2 Use ▲ / ▼ to highlight your selection.

3 Use ► to enter a sub-menu

4 Use ▲, ▼, ◀, ▶ to highlight your desired setting and press **OK** to confirm.

The **SETUP** menu includes:

General

Language	Set On Screen Display (OSD) languages
PBC settings	Set Playback Control function ON/OFF. This feature is available for Super VCD.
Power save	Set Power Saving mode ON/OFF
DivX (VOD)	Get the DivX (Video-On-Demand) code
Parental	Set parental options
Set password	Change password (default: 9999)
Factory settings	Restore factory settings

Video

TV Display	Set screen display aspect ratio
TV standard	Set video output format to TV system

Mpeg 4 subtitle Select subtitle language for Mpeg 4 video, e.g. DivX video

Audio

Dolby Set Dolby output

Digital (SPDIF) Set digital output format

5.2 Playback DVD

- 1 Briefly press **POWER** on the main control of the player to switch on the set.
- 2 Open the disc door and insert the disc.
 - The player will start to play the disc automatically.
- 3 Use **◀, ▶, ▲, ▼** to select an item from the DVD disc menu, such as play now, select languages and subtitle, and press **OK** to confirm.

The following functions are available during playback:

Pause Press **▶||** to pause playback. You can resume playback by pressing **▶||** again

Previous/Next Briefly press **◀◀** or **▶▶** once or several times to select your desired chapters

Fast backward / Fast forward

Keep pressing **◀◀** or **▶▶** to initiate backward/forward when 2x is shown on screen, press **◀◀** or **▶▶** briefly to change speed to 4x, 8x, 16x, 32x or resume normal playback. You may also press **▶||** to resume normal playback.

Volume Control

Press **+** or **-** briefly or repeatedly to increase or decrease the sound volume

Stop Briefly press **■** to stop playback

Subtitle	Change subtitle display. The function is available by pressing either the SUBTITLE or OPTIONS key
Language	Change language. The function is available by pressing either the AUDIO or OPTIONS key
Angle	Change the viewing angle provided in the DVD disc. The function is available by pressing the OPTIONS key.
Zoom	Zoom in the screen, and then use the navigation keys to pan the screen. The function is available by pressing either the ZOOM or OPTIONS key
A-B Repeat	Set repeat loop playback. Press A-B to set the starting point and press A-B again to set the ending point. Then, the player will repeat the loop playback. Press A-B to cancel the loop playback

5.3 Playback VCD



- 1 Briefly press **POWER** on the main control of the player to switch on the set.
 - 2 Open the disc door and insert the disc.
- The set will start to play the disc automatically.

The following functions are available during playback:

Pause Press **▶II** to pause playback. You can resume playback by pressing **▶II** again

Previous/Next Briefly press **◀◀** or **▶▶** once or several times to select your desired track

Fast backward / Fast forward

Keep pressing **◀◀** or **▶▶** to initiate backward/forward when 2x is shown on screen, press **◀◀** or **▶▶** briefly to change speed to 4x, 8x, 16x, 32x or resume normal playback. You may also press **▶||** to resume normal playback.

Volume Control

Press **+** or **-** briefly or repeatedly to increase or decrease the sound volume

Stop

Briefly press **■** to stop playback

Language

Some VCDs only contain 2 languages for selection. You can change the language using this function. The function is available by pressing either the **AUDIO** or **OPTIONS** key

Zoom

Zoom in the screen, and then use the navigation keys to pan the screen. The function is available by pressing either the **ZOOM** or **OPTIONS** key

A-B Repeat

Set repeat loop playback. Press **A-B** to set the starting point and press **A-B** again to set the ending point. Then, the player will repeat the loop playback. Press **A-B** to cancel the loop playback

5.4 Playback Super (S)-VCD

(Super) Video CDs may feature **PBC (Play Back Control)**. This allows you to play the video CDs interactively, following the menu on the display.

- 1 Briefly press **POWER** on the main control of the player to switch on the set.



- 2 Open the disc door and insert the disc. If **PBC** is on, the disc index menu will appear on the screen.
- 3 Use numeric keypad 0-9 to input your selection or select a play option.
- 4 Press **RETURN** on the remote control to return to the previous menu.
- 5 To turn Playback Control mode on/off, please go to **SETUP** and select **PBC settings**.

5.5 Playback Music CD



- 1 Briefly press **POWER** on the main control of the player to switch on the set.
- 2 Open the disc door and insert the disc.
 - The set will start to play the disc automatically.

The following functions are available during playback:

Pause Press **▶||** to pause playback. You can resume playback by pressing **▶||** again

Previous/Next Briefly press **◀◀** or **▶▶** once or several times to select your desired track

Fast backward / Fast forward

Keep pressing **◀◀** or **▶▶** to initiate backward/forward when 2x is shown on screen, press **◀◀** or **▶▶** briefly to change speed to 4x, 8x, 16x, 32x or resume normal playback. You may also press **▶||** to resume normal playback.

Volume Control

Press **+** or **-** briefly or repeatedly to increase or decrease the sound volume

Repeat	Press OPTIONS key to select Repeat 1 track or Repeat all tracks
Shuffle	Press OPTIONS key to turn shuffle playback on or off
Stop	Briefly press ■ to stop playback
A-B Repeat	Set repeat loop playback. Press A-B to set the starting point and press A-B again to set the ending point. Then, the player will repeat the loop playback. Press A-B to cancel the loop playback

5.6 Playback Music MP3-CD



- 1 Briefly press **POWER** on the main control of the player to switch on the set.
- 2 Open the disc door and insert the disc.
 - The set will start to play the disc automatically.
- 3 Use **◀▶**, **▲**, **▼** to select the folder and MP3 file to be played.

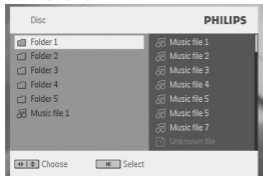

The following functions are available during playback:

Pause	Press ▶ to pause playback. You can resume playback by pressing ▶ again
Previous/Next	Briefly press ◀◀ or ▶▶ once or several times to select your desired track
Fast backward / Fast forward	Keep pressing ◀◀ or ▶▶ to initiate backward/forward when 2x is shown on screen, press ◀◀ or ▶▶ briefly to change speed to 4x, 8x, 16x, 32x or resume normal playback. You may also press ▶ to resume normal playback.
Volume Control	Press + or - briefly or repeatedly to increase or decrease the sound volume
Repeat	Press OPTIONS key to select Repeat 1 track or Repeat all tracks
Shuffle	Press OPTIONS key to turn shuffle playback on or off
Stop	Briefly press ■ to stop playback

5.7 Playback Picture-CD



The player can only read pictures in JPEG format.

- 1 Briefly press **POWER** on the main control of the player to switch on the set.
- 2 Open the disc door and insert the disc.
 - The set will start to play the disc automatically.
- 3 Use **◀**, **▶**, **▲**, **▼** to select the folder and JPEG file to be played.

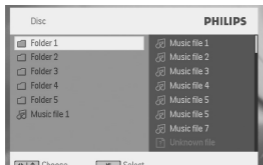

- Pause** Press **▶||** to pause playback. You can resume playback by pressing **▶||** again
-
- Previous/Next** Briefly press **◀◀** or **▶▶** once or several times to select your desired track
-
- Rotate** Press **OPTIONS** key to select rotate mode. Then, use **◀** to rotate the picture clockwise. Use **▶** to rotate the picture anti-clockwise. Press **OPTIONS** key to exit rotate mode.
-
- Slide show** Press **OPTIONS** key to select **Slide Show**, then press **OK** to confirm.
-
- Zoom** Zoom in the screen, and then use the navigation keys to pan the screen. The function is available by pressing either the **ZOOM** or **OPTIONS** key
-
- Stop** Briefly press **■** on the right side of the player to stop playback
-

6.1 DISPLAY Menu

When you press **DISPLAY** during playback, the following menu will appear and you can access the corresponding function and information:



Brightness	It allows you to adjust the brightness of the screen
Contrast	It allows you to adjust the contrast of the screen
Color	It allows you to adjust the color of the screen from cool, warm and normal.
Turn off LCD	You can turn off the screen in some situations, such as when connected to TV or playing music discs. This can save the battery power
Battery level	It shows type of power source in using.

6.2 Connection

6.2.1 Headphone

Connect the headphone to either one of the headphone jacks on the side of the player.

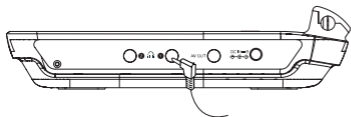

6.2.2 TV

You can connect the player to a TV and enjoy your DVD.

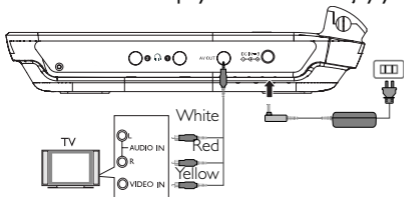

7 Troubleshooting

If it appears that the DVD-Video player is faulty, first consult this checklist. It may be that something has been overlooked.

WARNING Under no circumstances should you try to repair the set yourself as this will invalidate the guarantee.

If a fault occurs, first check the points listed, before taking the set for repair. If you are unable to solve a problem by following these hints, consult your dealer or service centre.

Symptom	Remedy
No power	<ul style="list-style-type: none">• Check if both plugs of the mains cord are properly connected.• Check if there is power at the AC outlet by plugging in another appliance.• Check if battery pack is inserted appropriately.• Check if car adaptor is connected appropriately.
Distorted picture	<ul style="list-style-type: none">• Check the disc for fingerprints and clean with a soft cloth, wiping from centre to edge.• Sometimes a small amount of picture distortion may appear. This is not a malfunction.

Symptom	Remedy
Completely distorted picture / no colour in the TV screen	The NTSC/PAL setting may be in the wrong status. Match your TV's setting with the player's setting.
No sound	Check audio connections. If using a HiFi amplifier, try another sound source.
Disc can't be played	<ul style="list-style-type: none"> • Ensure the disc label is upwards. • Clean the disc. • Check if the disc is defective by trying another disc.
The player does not respond to the remote control	Aim the remote control directly at the sensor on the front of the player. Avoid all obstacles that may interfere with the signal path. Inspect or replace the batteries.
Distorted or B/W picture with DVD	Use only discs formatted according to the TV-set used (PAL/NTSC).
Player does not respond to all operating commands during playback	<ul style="list-style-type: none"> • Operations are not permitted by the disc. • Refer to the instructions in the disc inlay.
Player feels warm	When the player is in use for a long period of time, the surface will be heated. This is normal.
Display goes dimmer when AC is unplugged	The unit is saving power to ensure longer playtime with battery. It is normal. Réglez la luminosité en appuyant sur le bouton DISPLAY button.

8 Technical data

Dimensions	20.5 x 16.8 x 4.5 cm 8.1 x 6.6 x 1.8 inches
Weight	1.07 kg / 2.36 lb
Power supply	DC 12V, 1A
Power Consumption	≤20W
Operating temperature range	0 - 50°C (32 - 122°F)
Laser wavelength	650nm
Video system	NTSC / PAL / AUTO

PHILIPS reserves the right to make design and specification changes for product improvement without prior notice. Modifications not authorized by the manufacturer may void users authority to operate this device. All rights reserved.

Copyright information

The making of unauthorized copies of copy-protected material, including computer programmes, files, broadcasts and sound recordings, may be an infringement of copyrights and constitute a criminal offence. This equipment should not be used for such purposes.

Disposal of your old product

Your product is designed and manufactured with high quality materials and components, which can be recycled and reused.

When this crossed-out wheeled bin symbol is attached to a product, it means the product is covered by the European Directive 2002/96/EC.

Please be informed about the local separate collection system for electrical and electronic products. Please act according to your local rules and do not dispose of your old product with your normal household waste. The correct disposal of your old product will help prevent potential negative consequences to the environment and human health.



Meet Philips at the Internet
<http://www.philips.com>

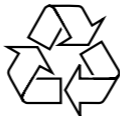

PET740

