

Quick start guide



Step A *Connect*

Step B *Setup*

Step C *Enjoy*

What's in the Box?

You should find these items upon opening the box.



Quick Start Guide

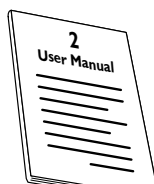

User manual

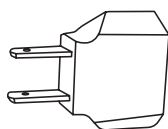

Round-to-flat pin adaptor

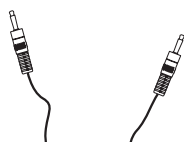

MP3 Link cable

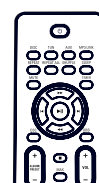

Remote Control

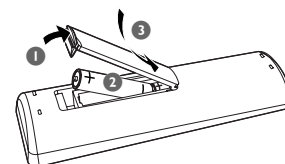

PHILIPS

Step A *Connect*

- 1 Connect the speaker cables.
- 2 Connect the power cable of the system.

Tip

See the *User Manual* for how to connect other equipment to this system.

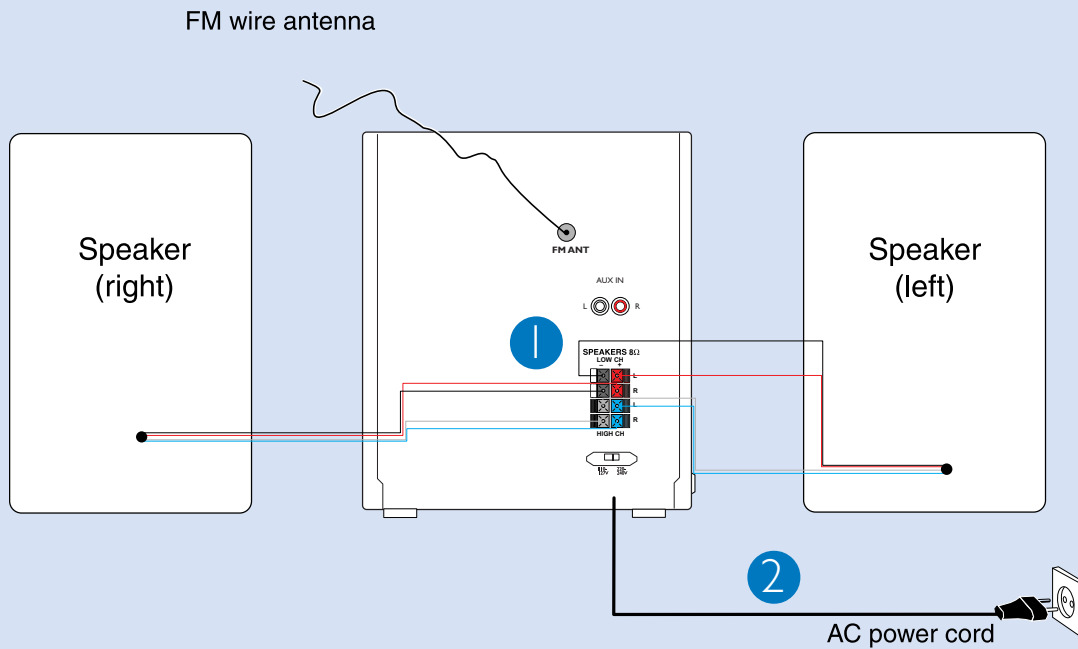

Step B *Setup*

Setting the clock

- 1 In standby mode, press and hold **CLOCK/DISPLAY**. The clock digits for the hours flash.
- 2 Press **◀◀/▶▶** on the system (**◀/▶** on the remote) to set the hours.
- 3 Press **CLOCK/DISPLAY** again. The clock digits for the minutes flash.
- 4 Press **◀◀/▶▶** on the system (**◀/▶** on the remote) to set the minutes.
- 5 Press **CLOCK/DISPLAY** to confirm the time.

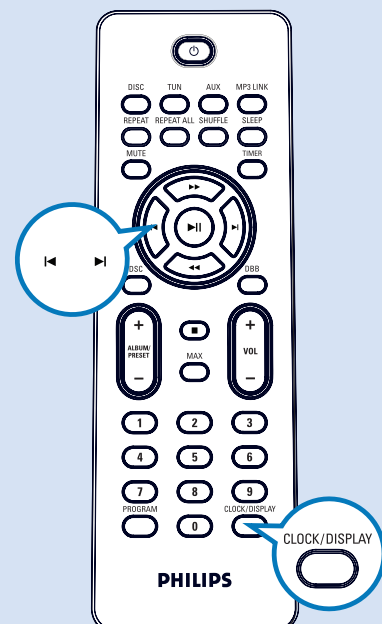

Playing a disc

- 1 Press **DISC** to select **DISC** source.
- 2 Press **OPEN/CLOSE** on the system to open the CD compartment.
- 3 Insert a disc with the printed side facing up and press **OPEN/CLOSE** to close the CD compartment.
- 4 Press **▶||** to start playback.
- 5 Press **■** to stop playback.

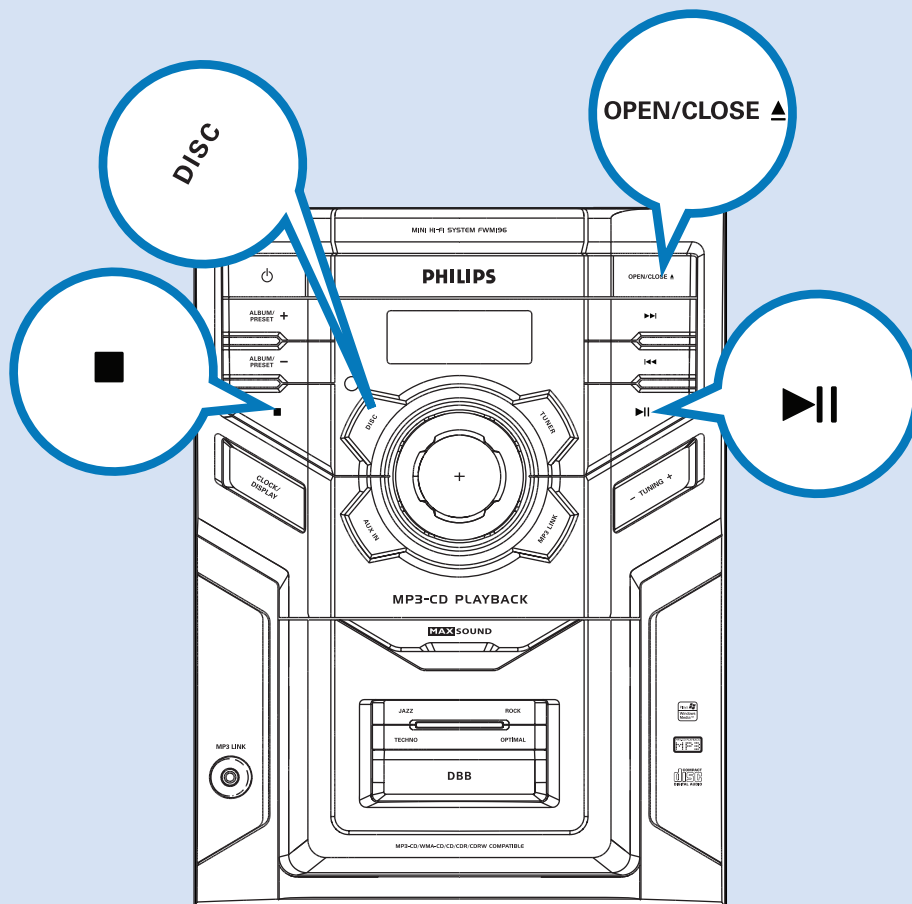

Programming and tuning to radio stations

- 1 Press **TUNER** on the system or **TUN** on the remote control to select **TUNER** source.
- 2 Press **TUNER** on the system or **TUN** on the remote control once or more to select desired waveband: FM or MW (AM).
- 3 Press and hold **PROGRAM** on the remote control for more than three seconds to program all available stations.
- 4 Press **ALBUM/PRESET +/-** until the desired preset station is displayed.

Tip

Detailed playback features and additional functions are described in the accompanied user manual.



© Royal Philips Electronics N.V. 2008
All rights reserved.

<http://www.philips.com>

