

Register your product and get support at

CEM5000

www.philips.com/welcome



EN Quick Start Guide

PHILIPS

1

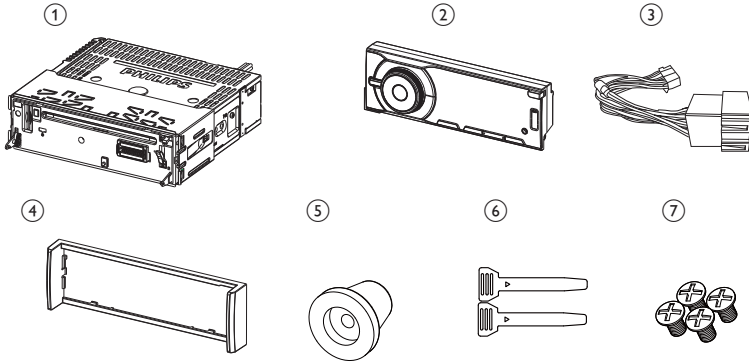

2

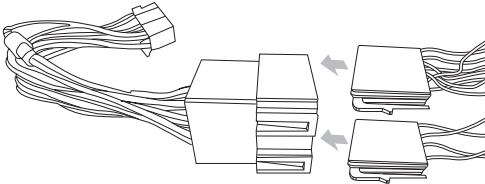

3

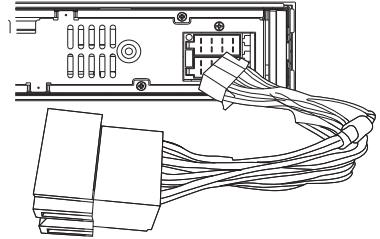

4

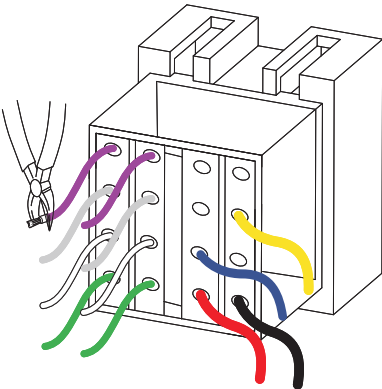

5

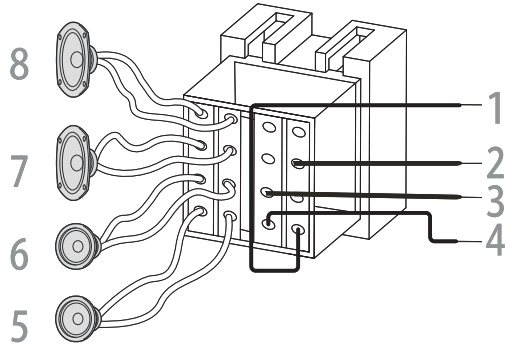

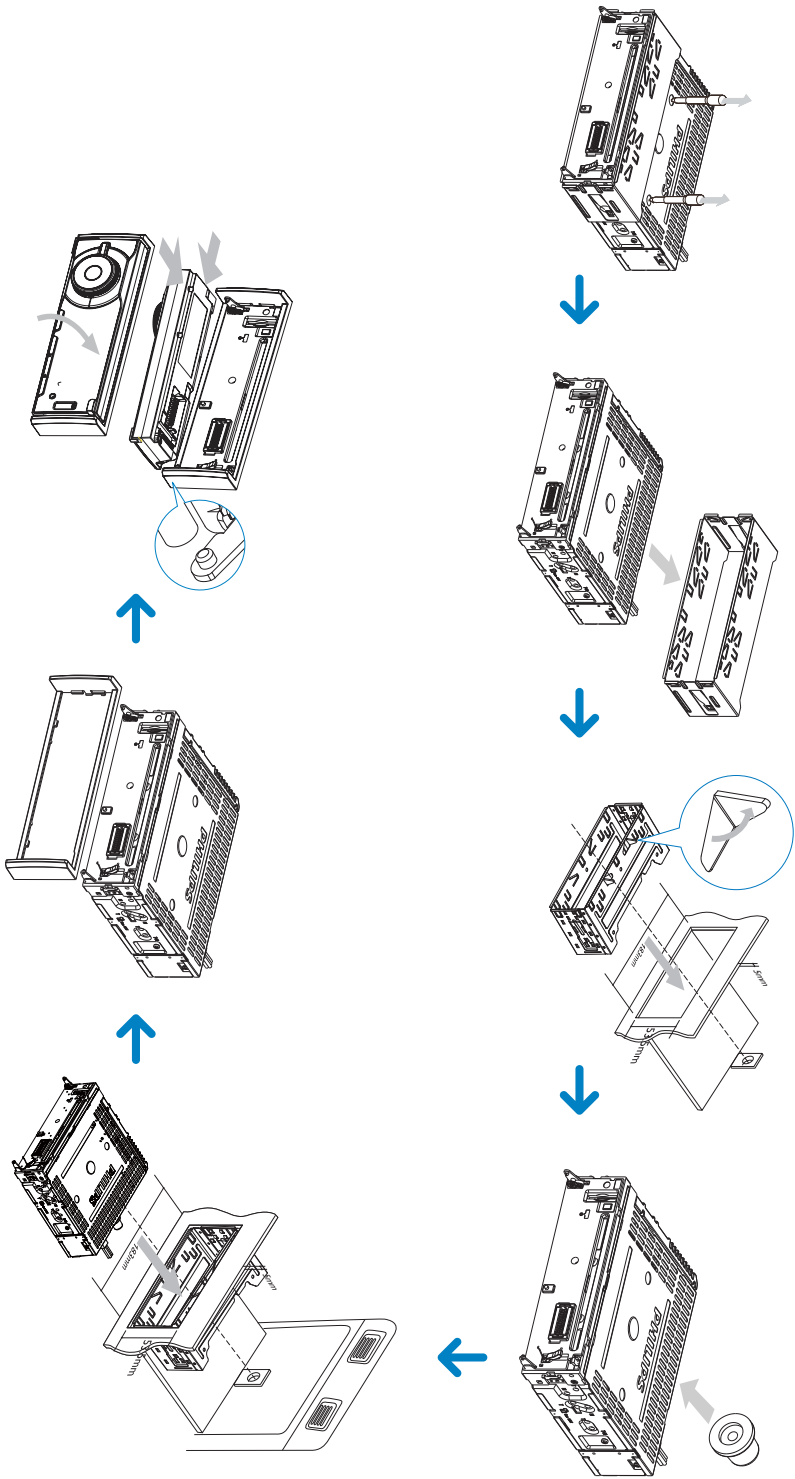

Overview of parts 1

These are the supplied parts needed to connect and install this unit.

- ① In-car audio system and sleeve
- ② Front panel
- ③ Standard connector
- ④ Trim plate
- ⑤ Rubber cushion
- ⑥ Disassembly tools
- ⑦ Screws (4 pieces)

Connect wires

Caution

- Ensure that all loose leads are insulated with electrical tape.

ISO connectors 2 3

- 1 Pull out the ISO connectors from the car dashboard and connect them to the bigger end of the supplied standard connector.
- 2 Connect the other end of supplied standard connector to the unit.
- 3 Do the other connections, if applicable.

Without ISO connectors 3 4 5

- 1 Cut off the bigger end of the supplied standard connector.
- 2 Check the car's wiring carefully, then connect them to the standard connector.
- 3 Connect the supplied standard connector to the unit.
- 4 Do the other connections, if applicable.

	Connector	Connect to
1	Black wire	A metal surface of the car First connect the black ground (earth) lead, then connect the yellow and red power supply leads.
2	Yellow wire	The +12V car battery which is live at all times.
3	Blue wire	Motor/electric antenna relay control lead/Amplifier relay control lead
4	Red wire	The +12V power terminal which is live in the accessory (ACC) position of the ignition switch If there is no accessory position, connect to the +12V car battery terminal that is always live. Be sure to connect the black ground (earth) lead to a metal surface of the car first.
5	Green and green/black wires	Left speaker (Rear)
6	White and white/black wires	Left speaker (Front)
7	Gray and gray/black wires	Right speaker (Front)
8	Purple and purple/black wires	Right speaker (Rear)

Mount in the dashboard 6



- 1 If the car does not have an on-board drive or navigation computer, disconnect the negative terminal of the car battery.
 - If you disconnect the car battery in a car that has an on-board drive or navigation computer, the computer may lose its memory.
 - If the car battery is not disconnected, to avoid short-circuit, ensure that bare wires do not touch each other.

- 2 Remove the two screws on the top of the unit.
- 3 Remove the mounting sleeve with the supplied disassembly tools.
- 4 Ensure that car dashboard opening is within these measurements.
- 5 Install the sleeve into the dashboard and bend the tabs outward to fix the sleeve.
- 6 Place the supplied rubber cushion over the end of the mounting bolt.
- 7 Slide the unit into the dashboard until you hear a click sound.
- 8 Reconnect the negative terminal of the car battery.

Attach the front panel



- 1 Attach the trim plate to the main unit.
- 2 Insert the right side of the panel in the chassis until it is correctly engaged.
- 3 Push the left side of the panel and point the left hole at the left pillar.
- 4 Release the panel to engage the left side.
- 5 Push the front side of the panel backward to the main unit a "click" is heard.

Turn on





- 1 Press  to turn on the unit.
 - To turn off the unit, press  for 3 seconds.

Set clock

- 1 Press **MENU** repeatedly until **[TIME FORMAT]** (time format) displays.
- 2 Use rotary encoder knob to toggle the settings:
 - **[TIME FORMAT 12H]**
 - **[TIME FORMAT 24H]**

- 3 Press  or  repeatedly until **[CLOCK SET]** (clock set) displays.
 - ↳ Hour digits blinks
- 4 Set hour with rotary encoder knob.
- 5 Press **OK/MUTE** to confirm.
 - ↳ Minute digits blinks
- 6 Set minute with rotary encoder knob.
- 7 Press  to confirm clock set and exit the menu.

Listen to radio

- 1 Press **SOURCE** repeatedly to select **[Radio]**.
- 2 Press  or  to select band: **[FM1]**, **[FM2]**, **[FM3]**, **[AM1]**, or **[AM2]**.
- 3 Press  or  to tune to a radio station manually.
 - ↳ The radio station is broadcast.

Play with RDS

The RDS (Radio Data System) function operates only in areas with FM stations broadcasting RDS signals. If you tune to an RDS station, an RDS icon and information about the presenter, station or program is displayed.

Turn on RDS



Note

- By default, the RDS function is off.
- To adjust the RDS function, the unit must be under Radio playback mode.

- 1 Press **MENU** for 3 seconds.
- 2 Rotate encoder knob to select **[RDS ON]**:
 - To turn off the RDS function, repeat steps above and choose **[RDS OFF]**.

Pairing bluetooth devices

You can pair your bluetooth device with the unit as follows:

- 1 Turn on bluetooth function on the device.
- 2 Search for other bluetooth devices that can pair with your device.
- 3 Select "Philips" in the pairing list.
- 4 Enter default password "0000".
 - ↳ **[Paired Ok!]**(paired ok) displays on the panel if pairing is successful.
 - ↳ The paired device connect to the car audio system automatically.

Terminate call



- 1 Press  to terminate call.

Make a call







Note





- To make a call on this unit, the bluetooth connection between the unit and the phone must be active.

- 1 Press  until **[NUM DIAL]** displays.
- 2 Press 0-9 to enter phone number.
 - Press  to delete entered numbers.
- 3 Press  to dial.

To redial number:

- 1 Press .
- 2 Press  or  to choose **[REDIAL]** (redial).
- 3 Press  again.
 - ↳ **[Calling]** (calling) displays and the unit starts dialing the number dialed last time.

To quick dial preset number:

- 1 Press .
- 2 Press  or  to choose **[QUICK DIAL]**.
- 3 Press **1** to **6** numeric keys to choose preset numbers.
 - ↳ Preset phone number displays.
- 4 Press  again.
 - ↳ **[Calling]** (calling) displays and the unit starts dialing the selected number.



© 2010 Koninklijke Philips Electronics N.V.

All rights reserved.

Document order number: CEM5000_55_QSG_V2.1

