

Register your product and get support at

www.philips.com/welcome

HTS5540

HTS5550

EN User manual

MS-MY Manual pengguna

ZH-TW 使用手冊

ZH-CN 用户手册

PHILIPS

Contents

1	Notice	2
	Copyright	2
	About Progressive Scan	2
	Trademarks	2

2	Important	3
	Safety	3
	Product care	3
	Disposal of your old product and batteries	4

3	Your home theater	4
	Main unit	4
	Remote control	5

4	Connect your home theater	6
	Connectors	6
	Connect to the TV	7
	Connect audio from TV or other devices	8
	Connect a wireless module	8
	Connect a microphone	8

5	Use your home theater	9
	Before you start	9
	Choose your sound	9
	Play a disc	9
	Play from a USB storage device	10
	More play features	11
	Play from radio	11
	Play audio from TV or other devices	12
	Play from an MP3 player	12
	Use Philips EasyLink	12
	Create MP3 audio files	13

6	Change settings	13
	Access the setup menu	13
	Change general settings	14
	Change audio settings	14
	Change video settings	15
	Change preference settings	15

7	Update software	16
	Check software version	16
	Update software from a CD-R or USB	16

8	Product specifications	16
----------	-------------------------------	----

9	Troubleshooting	18
----------	------------------------	----

10	Index	19
-----------	--------------	----

1 Notice

Copyright



**Be responsible
Respect copyrights**

This product incorporates copyright protection technology that is protected by method claims of certain U.S. patents and other intellectual property rights owned by Macrovision Corporation and other rights owners. Use of this copyright protection technology must be authorized by Macrovision Corporation, and is intended for home and other limited viewing uses only unless otherwise authorized by Macrovision Corporation. Reverse engineering or disassembly is prohibited.

About Progressive Scan

Consumers should note that not all high definition television sets are fully compatible with this product and may cause artifacts to be displayed in the picture. In case of 525 or 625 progressive scan picture problems, it is recommended that the user switch the connection to the 'standard definition' output. If there are questions regarding our TV set compatibility with this model 525p and 625p DVD player, please contact our customer service center.

Trademarks



Manufactured under license under U.S. Patent #'s: 5,451,942; 5,956,674; 5,974,380; 5,978,762; 6,487,535 & other U.S. and worldwide patents issued & pending. DTS and the Symbol are registered trademarks & DTS Digital Surround and the DTS logos are trademarks of DTS, Inc. Product includes software. © DTS, Inc. All Rights Reserved.



Manufactured under license from Dolby Laboratories. Dolby, Pro Logic, and the double-D symbol are trademarks of Dolby Laboratories.



DivX® and DivX Ultra® are registered trademarks of DivX, Inc. and are used under license.

DivX Ultra® Certified to play DivX® video with advanced features and premium content.

ABOUT DIVX VIDEO: DivX® is a digital video format created by DivX, Inc. This is an official DivX Certified device that plays DivX video. Visit www.divx.com for more information and software tools to convert your files into DivX video.

ABOUT DIVX VIDEO-ON-DEMAND: This DivX Certified® device must be registered in order to play DivX Video-on-Demand (VOD) content. To generate the registration code, locate the DivX VOD section in your device setup menu. Go to vod.divx.com with this code to complete the registration process and learn more about DivX VOD.



Windows Media and the Windows logo are trademarks, or registered trademarks of Microsoft Corporation in the United States and/or other countries.



HDMI, and HDMI logo and High-Definition Multimedia Interface are trademarks or registered trademarks of HDMI licensing LLC.



The USB-IF Logos are trademarks of Universal Serial Bus Implementers Forum, inc.

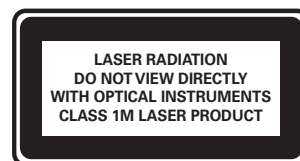

2 Important

Read and understand all instructions before you use your home theater. If damage is caused by failure to follow instructions, the warranty does not apply.

Safety

Risk of electric shock or fire!

- Never expose the product and accessories to rain or water. Never place liquid containers, such as vases, near the product. If liquids are spilt on or into the product, disconnect it from the power outlet immediately. Contact Philips Consumer Care to have the product checked before use.
- Never place the product and accessories near naked flames or other heat sources, including direct sunlight.
- Never insert objects into the ventilation slots or other openings on the product.
- Where the mains plug or an appliance coupler is used as the disconnect device, the disconnect device shall remain readily operable.
- Disconnect the product from the power outlet before lightning storms.
- When you disconnect the power cord, always pull the plug, never the cable.

Risk of short circuit or fire!

- Before you connect the product to the power outlet, ensure that the power voltage matches the value printed on the back or bottom of the product. Never connect the product to the power outlet if the voltage is different.

Risk of injury or damage to the home theater!

- For wall-mountable products, use only the supplied wall mount bracket. Secure the wall mount to a wall that can support the combined weight of the product and the wall mount. Koninklijke Philips Electronics N.V. bears no responsibility for improper wall mounting that results in accident, injury or damage.

- For speakers with stands, use only the supplied stands. Secure the stands to the speakers tightly. Place the assembled stands on flat, level surfaces that can support the combined weight of the speaker and stand.
- Never place the product or any objects on power cords or on other electrical equipment.
- If the product is transported in temperatures below 5°C, unpack the product and wait until its temperature matches room temperature before connecting it to the power outlet.
- Visible and invisible laser radiation when open. Avoid exposure to beam.
- Do not touch the disc optical lens inside the disc compartment.

Risk of overheating!

- Never install this product in a confined space. Always leave a space of at least four inches around the product for ventilation. Ensure curtains or other objects never cover the ventilation slots on the product.

Risk of contamination!

- Do not mix batteries (old and new or carbon and alkaline, etc.).
- Remove batteries if they are exhausted or if the remote control is not to be used for a long time.
- Batteries contain chemical substances, they should be disposed of properly.

Product care

- Do not insert any objects other than discs into the disc compartment.
- Do not insert warped or cracked discs into the disc compartment.
- Remove discs from the disc compartment if you are not using the product for an extended period of time.
- Only use microfiber cloth to clean the product.

Disposal of your old product and batteries



Your product is designed and manufactured with high quality materials and components, which can be recycled and reused.



When this crossed-out wheeled bin symbol is attached to a product it means that the product is covered by the European Directive 2002/96/EC. Please inform yourself about the local separate collection system for electrical and electronic products.

Please act according to your local rules and do not dispose of your old products with your normal household waste.

Correct disposal of your old product helps to prevent potential negative consequences for the environment and human health.



Your product contains batteries covered by the European Directive 2006/66/EC, which cannot be disposed with normal household waste.

Please inform yourself about the local rules on separate collection of batteries because correct disposal helps to prevent negative consequences for the environmental and human health.

3 Your home theater

Congratulations on your purchase, and welcome to Philips! To fully benefit from the support that Philips offers, register your home theater at www.philips.com/welcome.

Main unit

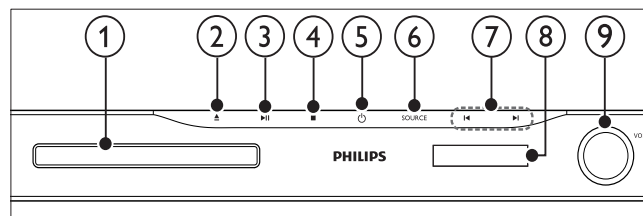

- ① **Disc compartment**
- ② **▲ (Open/Close)**
Opens or closes the disc compartment.
- ③ **▶|| (Play/Pause)**
Starts, pauses or resumes play.
- ④ **■ (Stop)**
 - Stops play.
 - In radio mode, erases the current preset radio station.
- ⑤ **⏻ (Standby-On)**
Switches the home theater on or to standby.
- ⑥ **SOURCE**
Selects an audio/video source for the home theater.
- ⑦ **◀/▶**
 - Skips to the previous or next track, chapter or file.
 - In radio mode, selects a preset radio station.
- ⑧ **Display panel**
- ⑨ **Volume control wheel**

Remote control

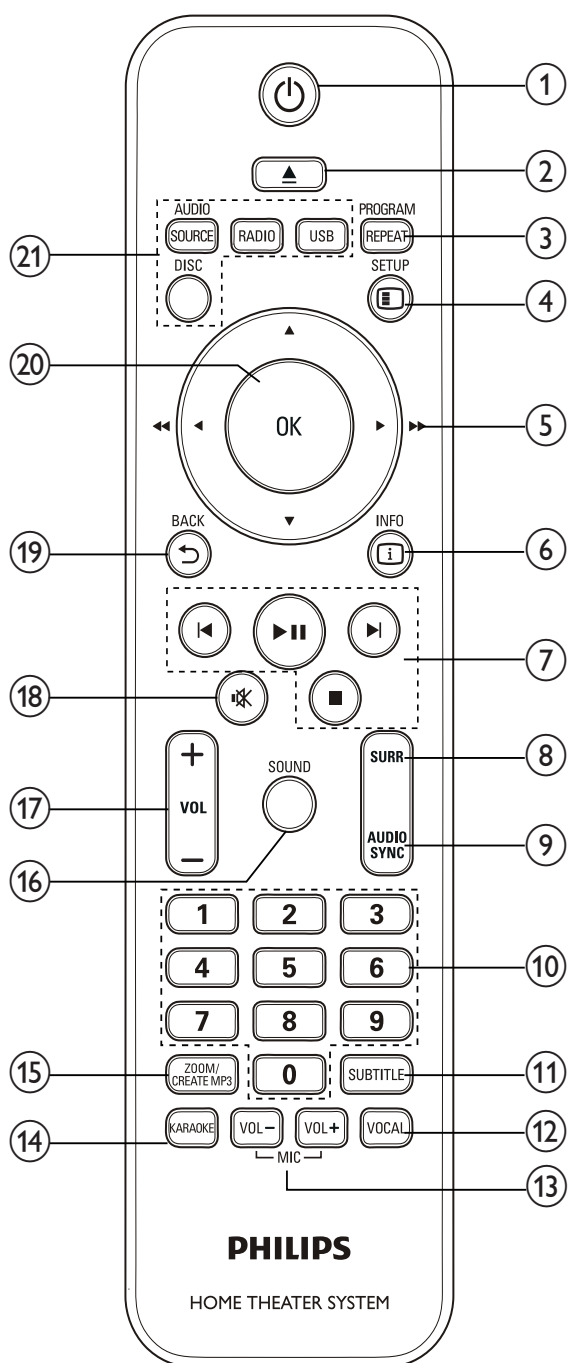

- ① **⏻ (Standby-On)**
- Switches the home theater on or to standby.
 - When EasyLink is enabled, press and hold for at least three seconds to switch all connected HDMI CEC compliant devices to standby.

- ② **▲ OPEN/CLOSE**
Opens or closes the disc compartment.

- ③ **REPEAT / PROGRAM**
- Selects a repeat or shuffle mode.
 - In radio mode, programs radio stations.
- ④ **⏏ SETUP**
Accesses or exits the setup menu.
- ⑤ **▲▼◀▶ (Navigation buttons)**
- Navigate menus.
 - In video mode, press left or right to fast backward or fast forward.
 - In radio mode, press left or right to search a radio station; press up or down to fine tune a radio frequency.
- ⑥ **ⓘ INFO**
Displays information about what is playing.
- ⑦ **Playback buttons**
Control playback.
- ⑧ **SURR (Surround Sound)**
Switches to surround sound or stereo sound.
- ⑨ **AUDIO SYNC**
- Selects an audio language or channel.
 - Press and hold to synchronize audio with video. Use with +/-.
- ⑩ **Numeric buttons**
Selects an item to play.
- ⑪ **SUBTITLE**
Selects subtitle language for video.
- ⑫ **VOCAL**
Turns off the vocal by changing the audio channel.
- ⑬ **MIC VOL +/-**
Increases or decreases microphone volume.
- ⑭ **KARAOKE**
Accesses or exits the karaoke menu.
- ⑮ **CREATE MP3 / ZOOM**
- Accesses the menu to create MP3.
 - Zooms into a video scene or picture.
- ⑯ **SOUND**
Selects a sound mode.
- ⑰ **VOL +/-**
Increases or decreases volume.
- ⑱ **⏮ (Mute)**
Mutes or restores volume.
- ⑲ **⏪ BACK**
Returns to a previous menu screen.

- ⑳ OK
Confirms an entry or selection.
- ㉑ Source buttons
 - **AUDIO SOURCE:** Selects an audio input source.
 - **RADIO:** Switches to FM radio.
 - **USB:** Switches to USB storage device.
 - **DISC:** Switches to disc source.

4 Connect your home theater

This section helps you connect your home theater to a TV and other devices. The basic connections of the home theater with its accessories are provided in the Quick Start. For a comprehensive interactive guide, see www.connectivityguide.philips.com.

Note

- Refer to the type plate at the back or bottom of the product for identification and supply ratings.
- Before you make or change any connections, ensure that all devices are disconnected from the power outlet.

Connectors

Front connectors

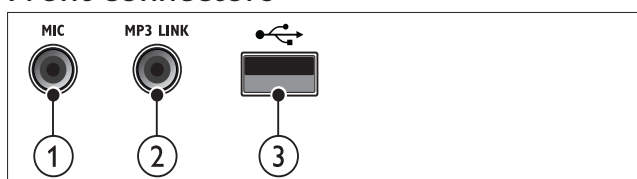

- ① **MIC**
Audio input from a microphone.
- ② **MP3 LINK**
Audio input from an MP3 player.
- ③ **USB**
Audio, video or picture input from a USB storage device.

Back connectors

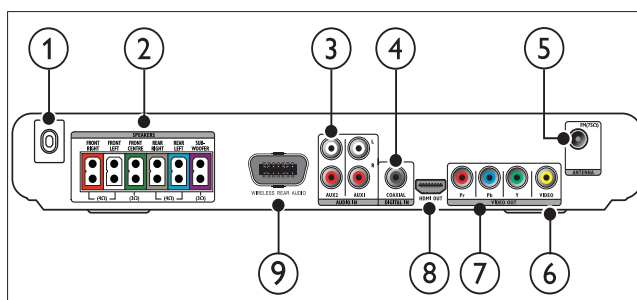

- ① **AC MAINS~**
Connects to the power supply.
- ② **SPEAKERS**
Connects to the supplied speakers and subwoofer.

- ③ **AUDIO IN-AUX 1/AUX 2**
Connects to the analog audio output on the TV or an analog device.
- ④ **DIGITAL IN-COAXIAL**
Connects to the coaxial audio output on the TV or a digital device.
- ⑤ **FM ANTENNA**
Connects the FM antenna for radio reception.
- ⑥ **VIDEO OUT-VIDEO**
Connects to the composite video input on the TV.
- ⑦ **VIDEO OUT-Y Pb Pr**
Connects to the component video input on the TV.
- ⑧ **HDMI OUT**
Connects to the HDMI input on the TV.
- ⑨ **WIRELESS REAR AUDIO**
Connects to a Philips wireless module. (Sold separately)

Connect to the TV

Connect your home theater directly to a TV through one of the following connectors (from highest to basic quality video):

- ① **HDMI**
- ② **Component video**
- ③ **Composite video**

Option 1: Connect to the TV through HDMI

Note

- If the HDTV has a DVI connector, connect using an HDMI/DVI adapter.
- If the TV supports EasyLink HDMI CEC, control the home theater and TV with one remote control (see 'Use Philips EasyLink' on page 12).

(Cable not supplied)

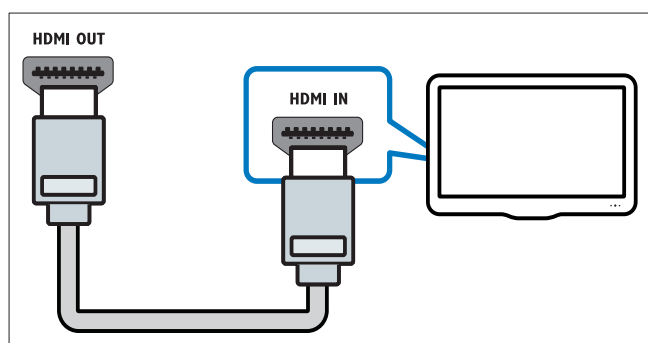

Option 2: Connect to the TV through YPbPr (component video)

Note

- The component video cable or connector might be labeled **Y Cb Cr** or **YUV**.

(Cable not supplied)

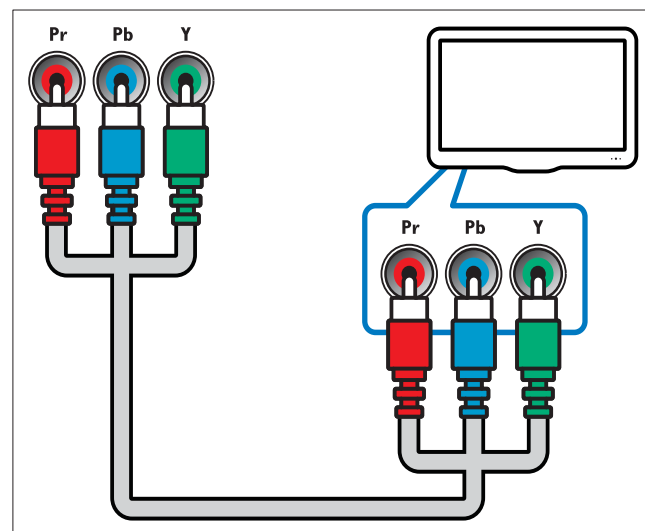

Option 3: Connect to the TV through composite video (CVBS)

Note

- The composite video cable or connector might be labeled **AV IN**, **VIDEO IN**, **COMPOSITE** or **BASEBAND**.

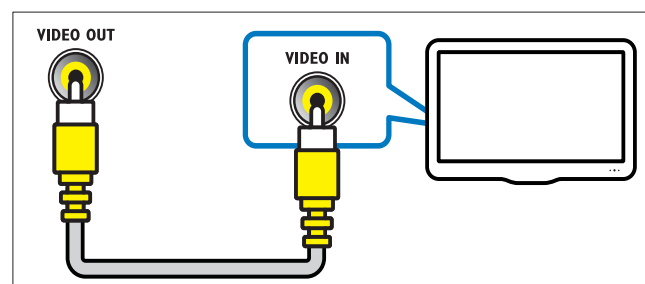

Connect audio from TV or other devices

Use your home theater to play audio from the TV or other devices such as a cable box.



Tip

- Press **AUDIO SOURCE** repeatedly to select the audio output of your connection.

Option 1: Connect audio through analog audio cables

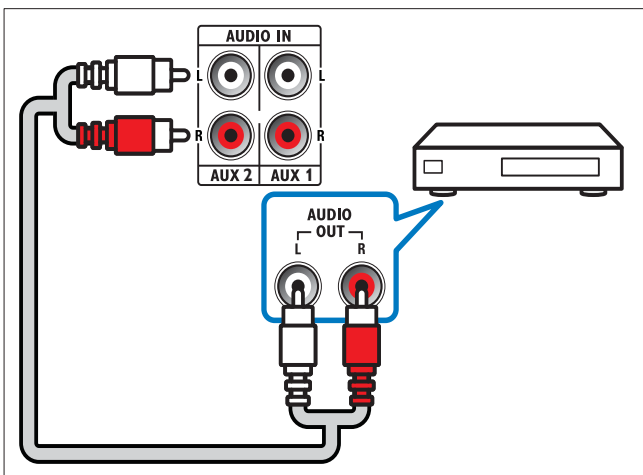
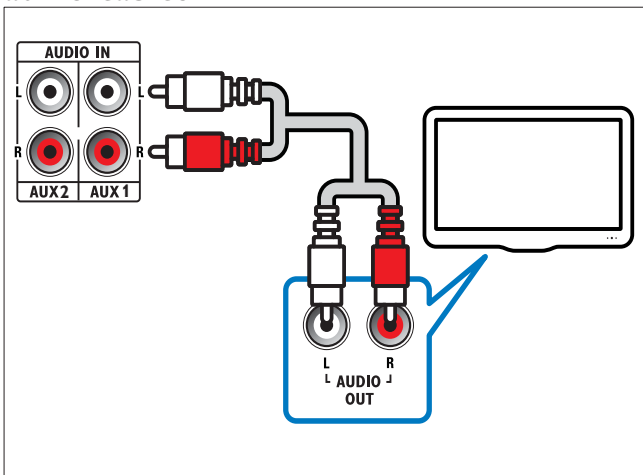

Option 2: Connect audio through coaxial cable



Note

- The digital coaxial cable or connector might be labeled **COAXIAL/DIGITAL OUT** or **SPDIF OUT**.

(Cable not supplied)

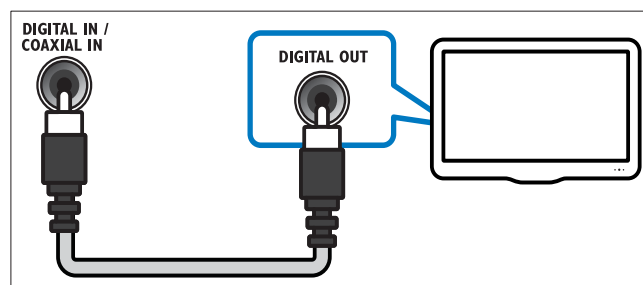

Connect a wireless module



Note

- When a wireless module is connected and switched on, the rear speakers of the home theater will be muted and the rear surround sound output to the wireless surround speakers.

(Wireless module not supplied)

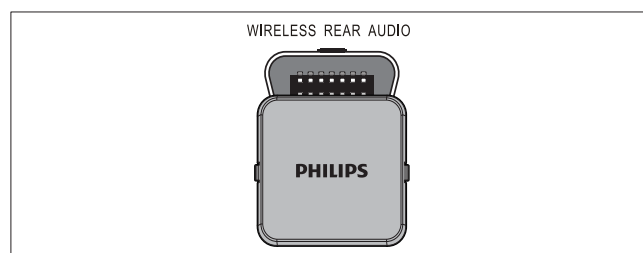

Connect a microphone

(Microphone not supplied)

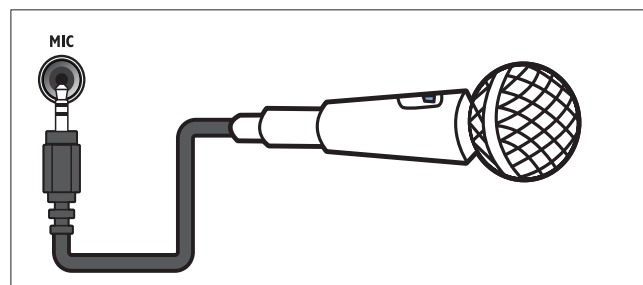

5 Use your home theater

This section helps you use the home theater to play media from a wide range of sources.

Before you start

Check that you:

- Make the necessary connections and complete the setup as described in the Quick Start.
- Switch the TV to the correct source for the home theater.

Choose your sound

This section helps you choose the ideal sound for your video or music.

Change sound mode

Select predefined sound modes to suit your video or music.

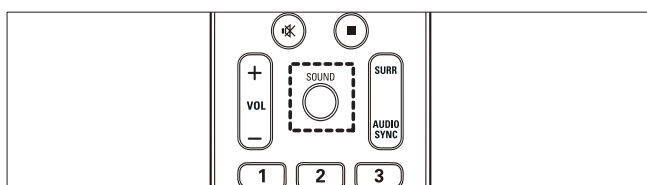

Press **SOUND** repeatedly to cycle through the available sound modes.

Sound mode	Description
ACTION / ROCK	Enhanced low and high-range. Ideal for action movies and rock or pop music.
DRAMA / JAZZ	Clear mid and high-range. Ideal for drama movies and jazz music.
CONCERT/ CLASSIC	Neutral sound. Ideal for live concerts and classical music.
SPORTS	Moderate mid-range and surround effects for clear vocals and the atmosphere of a live sport venue.
NIGHT	Dynamically controlled sound mode suitable for watching movies at night or for non-intrusive background music.

Change surround sound mode

Experience an immersive audio experience with surround sound modes.

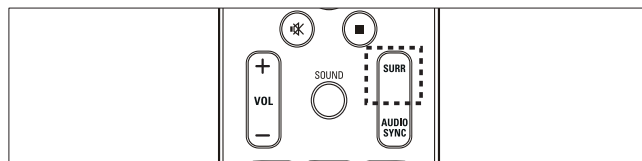

Press **SURRE** repeatedly to cycle through the available surround modes.

Option	Description
5CH STEREO	Enhances the stereo channel output by duplicating the sound output to the center and rear speakers. Ideal for party music.
MULTI-CHANNEL/ DPL II	Immersive multi-channel sound for an enhanced movie experience.
STEREO	Two-channel stereo sound. Ideal for listening to music.

Play a disc

The home theater can play a wide variety of discs, including video, audio and mixed media (for example, a CD-R that contains JPEG pictures and MP3 music).

- 1 Insert a disc into the home theater.
- 2 Press **DISC**.
↳ The disc plays or the disc main menu appears.
- 3 Press the following buttons to control play:

Button	Action
Navigation buttons	Navigate menus.
OK	Confirms an entry or selection.
▶ 	Starts, pauses or resumes play.
■	Stops play.
◀/▶	Skips to the previous or next track, chapter or file.
◀◀/▶▶	Fast backwards or fast forwards. Press repeatedly to change the search speed. In pause mode, steps forward by one frame.
ZOOM	Zooms into a video scene or picture.

Use video options

Access several useful features while viewing video.

Note

- Available video options depend on the video source.

Button	Action
▲ / ▼	Searches slow-backward or slow-forward. Press repeatedly to change the search speed. For VCD/SVCD, slow-backward search is not available.
AUDIO SYNC	Selects an audio language or channel.
SUBTITLE	Selects subtitle language for video.
 INFO	Displays information about what is playing.
REPEAT	Repeats a chapter or title.

Use picture options

Access several useful features while viewing pictures.

Button	Action
▲ / ▼	Rotates the picture counter-clockwise or clockwise.
◀ / ▶	Skips to the previous or next picture.
REPEAT	Repeats a single file in the folder or repeats the entire folder. Shuffles files in a folder.
 INFO	Displays photo albums in a thumbnail overview.

Use audio options

Access several useful features while audio is played.

Button	Action
REPEAT	Repeats a track, the entire disc or shuffle tracks.

Use karaoke options

Access several useful features while playing karaoke disc.

Note

- Ensure that a microphone (not supplied) is connected to the **MIC** connector on this home theater before play.

Button	Action
KARAOKE	Accesses or exits the karaoke menu. [Mic] : Enables or disables microphone output. [Echo Level] : Sets the echo level. [Key] : Sets the pitch level to match your voice. [Score] : Selects a rating level.
MIC VOL +/-	Increases or decreases microphone volume.
VOCAL	Turns off the vocal by changing the audio channel.

Play from a USB storage device

The home theater is fitted with a USB connector that allows you to view pictures, listen to music or watch movies stored on a USB storage device.

- 1 Connect the USB storage device to the home theater.
- 2 Press **USB**.
↳ A content browser appears.
- 3 Select a file, then press **OK**.
- 4 Press the playback buttons to control play (see 'Play a disc' on page 9).

Note

- If the USB storage device does not fit into the connector, use a USB extension cable.
- The home theater does not support digital cameras that need a computer program to display photos.
- The USB storage device must be FAT or DOS-formatted, and Mass Storage Class compliant.

More play features

Several advanced features are available for video or picture playback from a disc or USB storage device.

Play a musical slideshow

Play music and pictures simultaneously to create a musical slideshow. The files must be stored on the same disc or USB storage device.

- 1 Select a music track, then press **OK**.
- 2 Press **↩ BACK** and go to the picture folder.
- 3 Select a picture, then press **OK** to start slideshow.
- 4 Press **■** to stop slideshow.
- 5 Press **■** again to stop music.

Synchronize audio with video

If the audio and video are not synchronized, you can delay the audio to match the video.

- 1 Press and hold **AUDIO SYNC** until the audio sync message appears on the display panel.
- 2 Press **+/-** within five seconds to sync the audio with your video.

Quick skip play to a specific time

Quick skip to a specific part of a video by entering the time of a scene.

- 1 During video play, press **ⓘ INFO**.
- 2 Press the **Navigation buttons** and **OK** to select:
 - **[TT Time]** : Title time.
 - **[Ch Time]** : Chapter time.
 - **[Disc Time]** : Disc time.
 - **[Track Time]** : Track time.
- 3 Enter the time of the scene, then press **OK**.

Repeat play a specific section

Select sections of audio or video for repeat playback.

- 1 During playback, press **ⓘ INFO**.

- 2 Select **[Repeat] > [↺ AB]** in the menu.
- 3 Press **OK** to mark the start point.
- 4 Press **OK** again to mark the end point.
 - ↳ Repeat play starts.
 - To cancel repeat A-B, press **ⓘ INFO**, select **[Repeat] > [Off]**, then press **OK**.

Note

- Repeat play is only possible within a track/ chapter.

Play from radio

The home theater can store up to 40 radio stations.

- 1 Check that the FM antenna is connected.
- 2 Press **RADIO**.
 - ↳ "AUTO INSTALL...PRESS PLAY" appears on the display panel if you have not installed any radio stations. Press **▶||**.
- 3 Press the following buttons to control play:

Button	Action
◀ / ▶	Selects a preset radio station.
◀◀ / ▶▶	Searches for a radio station.
▲▼	Fine tunes a radio frequency.
■	Press and hold to erase the preset radio station. Press to stop the installation of radio stations.
PROGRAM	Manual: Press once to access program mode, and press again to store the radio station. Automatic: Press and hold for five seconds to reinstall radio stations.

Note

- AM and digital radio are not supported.
- If no stereo signal is detected, or if fewer than five stations are found, you are prompted to install the radio stations again.
- For the best reception, place the antenna away from the TV or other sources of radiation.

Change tuning grid

In some countries, you can switch the FM tuning grid between 50 kHz and 100 kHz. Changing tuning grid erases all preset radio stations.

- 1 Press **RADIO**.
- 2 Press **■**.
- 3 Press and hold **▶||** until 'GRID 9' (50 kHz) or 'GRID 10' (100 kHz) is displayed.

Play audio from TV or other devices

Press **AUDIO SOURCE** repeatedly to select the audio output of the connected device.

Play from an MP3 player

Connect and play audio files from an MP3 player or other external audio devices.

- 1 Connect the MP3 player to the home theater.
- 2 Press **AUDIO SOURCE** repeatedly until '**MP3 LINK**' appears on the display panel.
- 3 Press the buttons on the MP3 player to select and play audio files.

Use Philips EasyLink

The home theater supports Philips EasyLink, which uses the HDMI CEC (Consumer Electronics Control) protocol. EasyLink-compliant devices that are connected through HDMI connectors can be controlled by a single remote control.



Note

- Philips does not guarantee 100% interoperability with all HDMI CEC devices.

- 1 Switch on the HDMI CEC operations on the TV and other connected devices. See the manual of the TV or other devices for details.
- 2 Press **⏸** **SETUP**.
- 3 Select **[General Setup]**, then press **OK**.
- 4 Select **[EasyLink Setup]**, then press **OK**.
- 5 Select and adjust the following settings:
 - **[EasyLink]** : Enables or disables EasyLink.
 - **[One Touch Play]** : Enables or disables One Touch Play.
If enabled, you can use the remote control to start disc play in the home theater and the TV switches automatically to the correct channel.
 - **[One Touch Standby]** : Enables or disables One Touch Standby.
If enabled, the home theater can be switched off to standby by a remote control from the TV or other connected HDMI CEC devices.
 - **[System Audio Control]** : Enables or disables System audio control.
If enabled, follow the instructions on the TV to map the connected devices correctly to the audio connectors of the home theater. The home theater switches automatically to the audio source of the connected device.
 - **[Audio Input Mapping]** : Updates audio input mapping if there are new devices connected.
- 6 Press **OK** to confirm your choice.



Note

- The connected devices must be connected through HDMI and switched on.

Create MP3 audio files

Use the home theater to convert audio CDs into MP3 audio files.

- 1 Insert an audio CD (CDDA/HDCCD) into the home theater.
- 2 Connect a USB storage device to the home theater.
- 3 When audio is played, press **CREATE MP3**.

CREATE MP3			
OPTIONS		TRACK	
Speed	Normal	<input type="radio"/> Track01	04:14
Bitrate	128kbps	<input type="radio"/> Track02	04:17
		<input type="radio"/> Track03	03:58
		<input type="radio"/> Track04	04:51
		<input type="radio"/> Track05	03:53
		<input type="radio"/> Track06	04:09
		<input type="radio"/> Track07	04:38
			▼
SUMMARY			
Select Track	0		
Time	00:00		
Start	Exit	Select All	Deselect All

- 4 Select the conversion settings in the **[OPTIONS]** panel, then press **OK**.
 - **[Speed]** : Selects the write-to-file speed.
 - **[Bitrate]** : Selects the conversion quality.
- 5 Press **▶** to access the **[TRACK]** panel.
- 6 Select an audio track, then press **OK**.
 - **[Select All]** : Selects all tracks.
 - **[Deselect all]** : De-selects all tracks.
- 7 Select **[Start]** in the menu to convert, then press **OK**.
 - ↳ A new folder is created in the USB storage device to store all the new MP3 audio files.
 - To exit the menu, select **[Exit]** and press **OK**.

Note

- During the conversion process, do not press any buttons.
- DTS CDs and copy-protected CDs cannot be converted.
- Write-protected or password-protected USB storage device cannot be used to store MP3 files.

6 Change settings

This section helps you to change the settings of your home theater.



Caution

- Many of the settings are already configured with the best value for the home theater. Unless you have a specific reason to change a setting, it is best to leave it at the default value.

Access the setup menu

- 1 Press **⏏** **SETUP**.
 - ↳ The following menu appears.

Symbol	Description
	[General Setup]
	[Audio Setup]
	[Video Setup]
	[Preference Setup]

- 2 Select a setup menu, then press **OK**. See the following sections for information about how to change the settings of your home theater.
- 3 Press **⏏** **BACK** to return to the previous menu, or press **⏏** **SETUP** to exit.



Note

- You cannot change a setting that is grayed out.

Change general settings

- 1 Press  **SETUP**.
- 2 Select **[General Setup]**, then press **OK**.
- 3 Select and adjust the following settings:
 - **[EasyLink Setup]** : Sets up EasyLink to enjoy easy controls of all the HDMI CEC compliant devices using a single remote control (see 'Use Philips EasyLink' on page 12).
 - **[Disc Lock]** : Restricts play to disc. Password (PIN code) is required to unlock the disc before play.
 - **[Display Dim]** : Changes the brightness of the display panel.
 - **[OSD Language]** : Selects the on-screen display menu language.
 - **[Screen Saver]** : Enables or disables screen saver mode. If enabled, the screen enters idle mode after 10 minutes of inactivity (for example, in pause or stop mode).
 - **[Sleep Timer]** : Sets a sleep timer to switch the home theater to standby after a specific time.
 - **[DivX® VOD Code]** : Displays the DivX VOD registration code for the home theater.
- 4 Press **OK** to confirm your choice.

 **Note**

- Before you purchase DivX videos and play them on the home theater, register the home theater on www.divx.com using the DivX VOD code.

Change audio settings

- 1 Press  **SETUP**.
- 2 Select **[Audio Setup]**, then press **OK**.
- 3 Select and adjust the following settings:
 - **[Speakers Volume]** : Sets the volume of each speaker to obtain the ideal audio balance.
 - **[Speakers Delay]** : Sets the delay time for center and rear speakers to obtain an equal audio transmission from all the speakers.
 - **[HDMI Audio]** : Enables or disables HDMI audio output for the TV.
 - **[CD Upsampling]** : Converts the music CD to a higher sampling rate using sophisticated digital signal processing for better sound quality.
 - **[Audio Sync]** : Sets a delay for audio output when you play a video disc.
- 4 Press **OK** to confirm your choice.

 **Note**

- For settings related to HDMI, the TV must be connected through HDMI.
- CD upsampling is only available in stereo mode.

Change video settings

- 1 Press  **SETUP**.
- 2 Select **[Video Setup]**, then press **OK**.
- 3 Select and adjust the following settings:
 - **[TV System]** : Selects a TV system that is compatible with the TV.
 - **[TV Display]** : Selects a picture display format to fit the TV screen.
 - **[Screen Fit]** : Selects a full screen format that best fits to the TV screen.
 - **[Picture Settings]** : Selects a predefined color setting.
 - **[HDMI Setup]** : Selects HDMI video resolution and the wide screen display format for the TV. The Wide Screen Display option is only available for 16:9 wide screen TV display setting.
 - **[Progressive]** : Enables or disables progressive scan mode.
- 4 Press **OK** to confirm your choice.



Note

- Some video settings depend on the video source, ensure that the disc and the TV support the setting or feature.
- The best setting is automatically selected for the TV. If you need to change the setting, ensure that the TV supports the new setting.
- For settings related to HDMI, the TV must be connected through HDMI.
- For settings related to progressive or component video, the TV must be connected through Component Video.

Change preference settings

- 1 Press  **SETUP**.
- 2 Select **[Preference Setup]**, then press **OK**.
- 3 Select and adjust the following settings:
 - **[Audio]** : Selects audio language for video.
 - **[Subtitle]** : Selects subtitle language for video.
 - **[Disc Menu]** : Selects menu language for video disc.
 - **[Parental]** : Restricts access to discs that are recorded with ratings. To play all discs irrespective of the rating, select level '8'.
 - **[PBC]** : Displays or skips the content menu for VCD and SVCD discs.
 - **[MP3/JPEG Display]** : Displays the MP3/JPEG folders or all the files.
 - **[Password]** : Sets or changes a PIN code to play a restricted disc. Enter '0000' if you do not have a PIN or if you have forgotten your PIN.
 - **[DivX Subtitle]** : Selects a character set that supports the DivX subtitle.
 - **[Version Info.]** : Displays the software version for the home theater.
 - **[Default]** : Resets the home theater to the default settings programmed at the factory.
- 4 Press **OK** to confirm your choice.



Note

- If you select a language that is not available on a disc, the home theater uses the default language of the disc.
- You cannot reset disc lock, password (PIN code) and parental control settings to their default values.

7 Update software

To check for new updates, compare the current software version of your home theater with the latest software version (if available) on the Philips web site.

Check software version

- 1 Press  **SETUP**.
- 2 Select **[Preference Setup] > [Version Info.]**, then press **OK**.
 - ↳ The software version is displayed.

Update software from a CD-R or USB

- 1 Check for the latest software version on www.phillips.com/support.
 - Search for your model and click on 'software&drivers'.
- 2 Download the software onto a CD-R or USB storage device.
- 3 Insert the CD-R or connect the USB storage device to the home theater.
- 4 Follow the instructions on the TV to confirm the update.
 - ↳ When the update is complete, the home theater automatically switches to standby.
- 5 Disconnect the power cord for a few seconds and then reconnect it.

Caution

- Do not turn off the power or remove the CD-R or USB storage device when the software update is in progress because you might damage the home theater.

8 Product specifications

Note

- Specification and design are subject to change without notice.

Region code

Country	DVD
Europe, United Kingdom	 
Asia Pacific, Taiwan, Korea	 
Latin America	 
Australia, New Zealand	 
Russia, India	 
China	 

Playback media

DVD-Video, DVD+R/+RW, DVD-R/-RW, DVD+R DL, CD-R/CD-RW, Audio CD, Video CD/SVCD, Picture CD, MP3-CD, WMA-CD, DivX-CD, USB storage device

File Format

- Audio: .mp3, .wma
- Video: .divx, .divx ultra, .mpeg, .mpg, .wmv (simple profile)
- Picture: .jpeg, .jpg

Amplifier

- Total output power: 1200 W RMS (30% THD)
- Frequency response: 20 Hz-20 kHz / ± 3 dB
- Signal-to-noise ratio: > 65 dB (CCIR) / (A-weighted)
- Input sensitivity:
 - AUX: 900 mV
 - MP3 LINK: 500 mV

Video

- Signal system: PAL / NTSC
- HDMI output: 480i/576i, 480p/576p, 720p, 1080i, 1080p

Audio

- S/PDIF Digital audio input:
 - Coaxial: IEC 60958-3
- Sampling frequency:
 - MP3: 32 kHz, 44.1 kHz, 48 kHz
 - WMA: 44.1 kHz, 48 kHz
- Constant bit rate:
 - MP3: 112 kbps - 320 kbps
 - WMA: 48 kbps - 192 kbps

Radio

- Tuning range: FM 87.5-108 MHz (50/100 kHz)
- Signal-to-noise ratio: FM 50 dB
- Frequency response: FM 180 Hz ~ 10 kHz / ± 6 dB

USB

- Compatibility: Hi-Speed USB (2.0)
- Class support: UMS (USB Mass Storage Class)
- File system: FAT12, FAT16, FAT32
- Maximum memory support: < 160GB.

Main Unit

- Power supply:
 - Asia Pacific/Latin America: 110-127V/220-240V; ~50-60Hz switchable
 - Russia/China/India: 220-240V, ~50Hz
- Power consumption: 150 W
- Standby power consumption: < 0.9 W
- Dimensions (WxHxD): 435 x 58 x 358 (mm)
- Weight: 3.56 kg

Subwoofer

- Impedance: 3 ohm
- Speaker drivers: 165 mm (6.5") woofer
- Frequency response: 40 Hz-150 kHz
- Dimensions (WxHxD): 196 x 395 x 342 (mm)
- Weight: 5.25 kg
- Cable length: 3 m

Speakers

- System: full range satellite
- Speaker impedance: 3 ohm (center), 4 ohm (Front/Rear)
- Speaker drivers: 2 x 3" full range
- Frequency response: 150 Hz-20 kHz
- Dimensions (WxHxD):
 - Center: 280 x 95 x 92 (mm)
 - Speaker : 100 x 280 x 115 (mm)
 - Tall speaker: 260 x 1101 x 260 (mm)
- Weight:
 - Center: 1.40 kg
 - Speaker: 1.05 kg/each
 - Tall speaker: 3.73~3.81 kg/each
- Cable length:
 - Center: 2 m
 - Front: 3 m
 - Rear: 10 m

Laser specification

- Type: Semiconductor laser GaAlAs (CD)
- Wave length: 645 - 665 nm (DVD), 770 - 800 nm (CD)
- Output power: 6 mW (DVD), 7 mW (VCD/CD)
- Beam divergence: 60 degrees.

9 Troubleshooting



Warning

- Risk of electric shock. Never remove the casing of the product.

To keep the warranty valid, never try to repair the product yourself.

If you have problems using this product, check the following points before you request service. If you still have a problem, register your product and get support at www.philips.com/welcome.

If you contact Philips, you will be asked for the model and serial number of your product. The model number and serial number are on the back or bottom of your product. Write the numbers here:

Model No. _____

Serial No. _____

Main unit

The buttons on this home theater do not work.

- Disconnect the home theater from the power outlet for a few minutes, then reconnect.

Picture

No picture.

- Ensure that the TV is switched to the correct source for this home theater.
- If this happens when you change the TV system, switch to its default mode: 1) Press **▲**. 2) Press **◀**. 3) Press **SUBTITLE**.
- If this happens when you switch on the progressive scan mode, switch to its default mode: 1) Press **▲**. 2) Press **◀**. 3) Press **AUDIO SYNC**.

No picture on HDMI connection.

- Check if the HDMI cable is faulty. Replace with a new HDMI cable.
- If this happens when you change the HDMI video resolution, switch to its default mode: 1) Press **▲**. 2) Press **◀**. 3) Press **ZOOM**.

Sound

No sound.

- Ensure that the audio cables are connected and select the correct input source (for example, **AUDIO SOURCE**) for the device you want to play.

No sound on HDMI connection.

- You might not hear any sound if the connected device is not HDCP (High-bandwidth Digital Content Protection) compliant or only DVI compatible. Use an analog or digital audio connection.
- Ensure that the **[HDMI Audio]** is enabled.

No sound from TV program.

- Connect an audio cable from the audio input on the home theater to the audio output on the TV, then press **AUDIO SOURCE** repeatedly to select the correct audio source.

Distorted sound or echo.

- Ensure that the TV volume is muted or set to minimum if you are playing audio through the home theater.

Audio and video are not synchronized.

- 1) Press and hold **AUDIO SYNC**.
2) Press **+/-** within five seconds.

Play

Disc cannot be played.

- Clean the disc.
- Ensure that the home theater supports the disc (see 'Product specifications' on page 16).
- Ensure that the home theater supports the region code of the DVD.
- For DVD±RW or DVD±R, ensure that the disc is finalized.

DivX video files cannot be played.

- Ensure that the DivX file is encoded according to the 'Home Theater Profile' with the DivX encoder.
- Ensure that the DivX video file is complete.

DivX subtitles do not display correctly.

- Ensure that the subtitle file name is the same as the movie file name.
- Select the correct character set: 1) Press **⏏** **SETUP**. 2) Select **[Preference Setup]**. 3) Select **[DivX Subtitle]**. 4) Select a supported character set. 5) Press **OK**.

The contents of a USB storage device cannot be read.

- Ensure that the format of the USB storage device is compatible with the home theater (see 'Product specifications' on page 16).
- Ensure that the USB storage device is formatted with a file system that is supported by the home theater (note that NTFS is not supported).

'No entry' or 'x' sign appears on the TV.

- The operation is not possible.

EasyLink feature does not work.

- Ensure that the home theater is connected to a Philips brand EasyLink TV and that EasyLink is on.

I do not want my home theater to be switched on when I switch on my TV.

- This is the correct behavior for Philips EasyLink (HDMI-CEC). To make the home theater work independently, switch off EasyLink.

10 Index

A

amplifier	16
audio	
cancel vocal	10
connection	8
language	15, 10
settings	14
synchronize with video	11
audio input mapping	12

C

care	3
change settings	13
connect	
audio from TV	8, 12
guide	6
microphone	8
other devices	8
TV	7
wireless module	8
connectors	6
contact us	18

D

disc	
play	9
supported discs	16
disposal of your product	4
DivX	
registration code	14
subtitle	15

E

EasyLink	
settings	12

F

file formats	16
---------------------	----

H

HDMI CEC (see Easylink)	12
--------------------------------	----

K

karaoke	
microphone	8
play	10

L

language	
audio	15
disc menu	15
on-screen display	14
subtitle	15

M

MP3	
create MP3 files	13
play	12

O

one-touch play	12
one-touch standby	12
overview	
connectors	6
main unit	4
remote control	5

P

password	15
picture	
options	10
slide show	11, 10
thumbnail overview	10
troubleshooting	18
play	
disc	9
karaoke	10
MP3 player	12
options	9
radio	11
troubleshooting	18
USB storage device	10
product care	3
product specifications	16
progressive scan	2

R

radio	
play	11
program	11
tune	11
tuning grid	12
recycle	4
region code	16
remote control	5
repeat	9, 11
rotate pictures	10

S

safety	3
settings	
audio	14
general	14
parental control	15
preferences	15
restore factory settings	15
video	15
software	
update	16
version	16
sound	
mode	9
surround	9
troubleshooting	18
subtitle	
language	10
system audio control	12

T

time search video	11
troubleshooting	18
TV	
audio from TV	8, 12
connect	7

U

USB	
play	10
software update	16

V

video	
options	10
settings	15
synchronize with audio	11
video on demand (VOD)	14
