

For product support, visit  
Para obtener asistencia técnica, visite  
Pour en savoir plus sur l'assistance sur les produits, visitez le site

[www.philips.com/support](http://www.philips.com/support)

HTL2153B



# Quick start guide

**PHILIPS**



**EN:** For further assistance, call the customer support service in your country.

- To obtain assistance in the U.S.A., Canada, Puerto Rico, or the U.S. Virgin Islands, contact Philips Customer Care Center at 1 (866) 226-6074
- To obtain assistance in Mexico, contact Philips Customer Care Center at 01 800 839 1989

**ES:** Para obtener mas informacion, llame al servicio de soporte al cliente de su pais.

- Para obtener asistencia en los Estados Unidos, en Canada, Puerto Rico o en las Islas Virgenes de los Estados Unidos, comuniquese con Centro de atencion al cliente de Philips al 1 (866) 226-6074
- Solo para Mexico CENTRO DE ATENCION A CLIENTES LADA.  
01 800 839 1989 Solo Para Mexico

**FR-CA:** Pour obtenir de l'aide supplementaire, communiquez avec le centre de service a la clientele de votre pays.

- Pour obtenir de l'aide aux Etats-Unis, au Canada, a Puerto Rico ou aux Iles Vierges americaines, communiquez avec le centre de service a la clientele Philips au : 1 (866) 226-6074
- Pour obtenir l'aide au Mexique, entrez en contact avec le centre de soin de client de Philips a 01 800 839 1989

For Product recycling information, please visit - [www.recycle.philips.com](http://www.recycle.philips.com)

Para obtener información de productos de reciclaje, por favor visite - [www.recycle.philips.com](http://www.recycle.philips.com)

Pour tout renseignement sur le recyclage des produits, veuillez visiter - [www.recycle.philips.com](http://www.recycle.philips.com)



- EN** Before using your product, read all accompanying safety information
- ES** Antes de usar su producto, lea toda la información de seguridad adjunta
- FR-CA** Avant d'utiliser votre appareil, prenez le temps de lire toute l'information de sécurité connexe

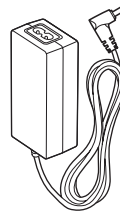
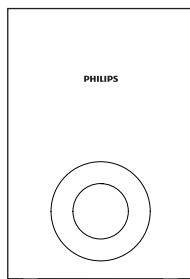

Power Adapter

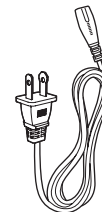

Power Cord



Cable Tie

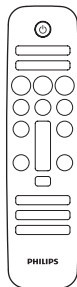

4 X

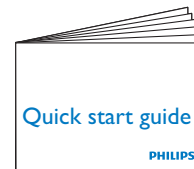
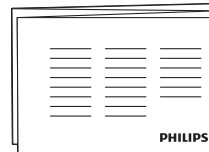

# 1

**EN** Assemble your SoundBar  
Position the SoundBar

**ES** Montaje del SoundBar  
Colocación del SoundBar

**FR-CA** Montez votre SoundBar  
Positionnez le SoundBar

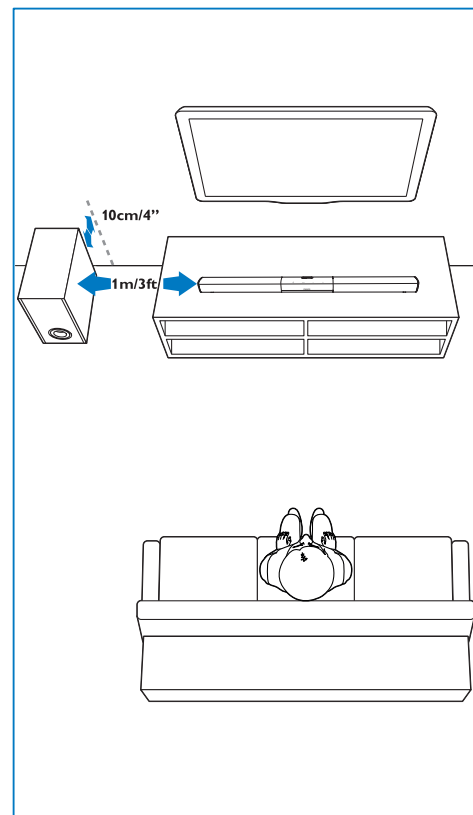
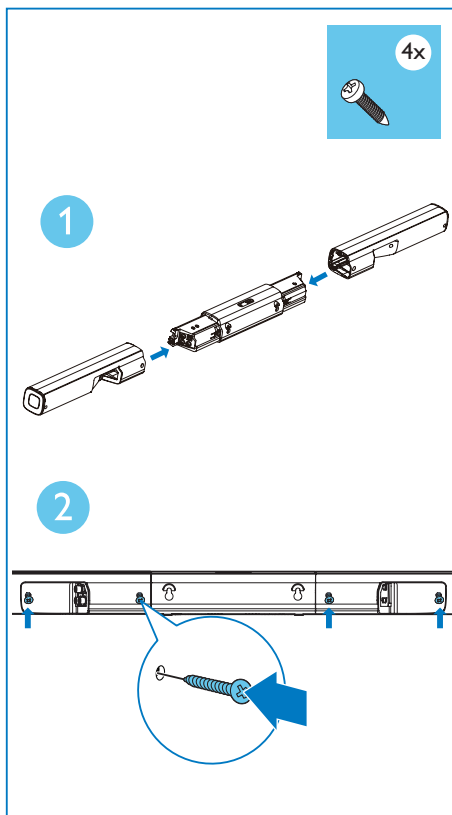

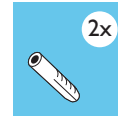

- EN** Wall mount the SoundBar (optional)
- ES** Montaje en pared del SoundBar (opcional)
- FR-CA** Fixez le SoundBar au mur (facultatif)

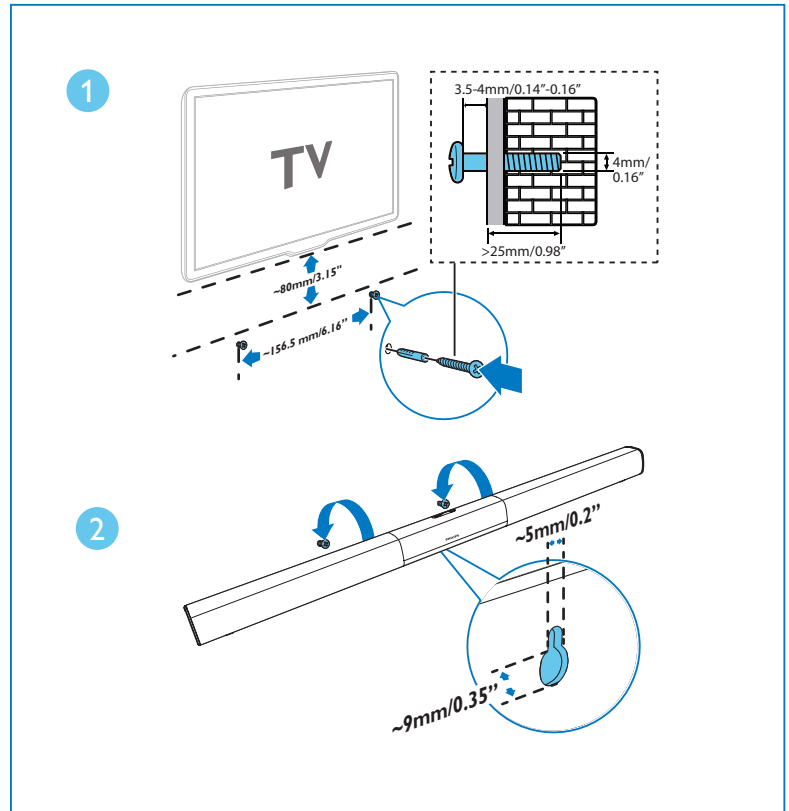

# 2

- EN** Connect the SoundBar
- ES** Conexión del SoundBar
- FR-CA** Branchez le SoundBar

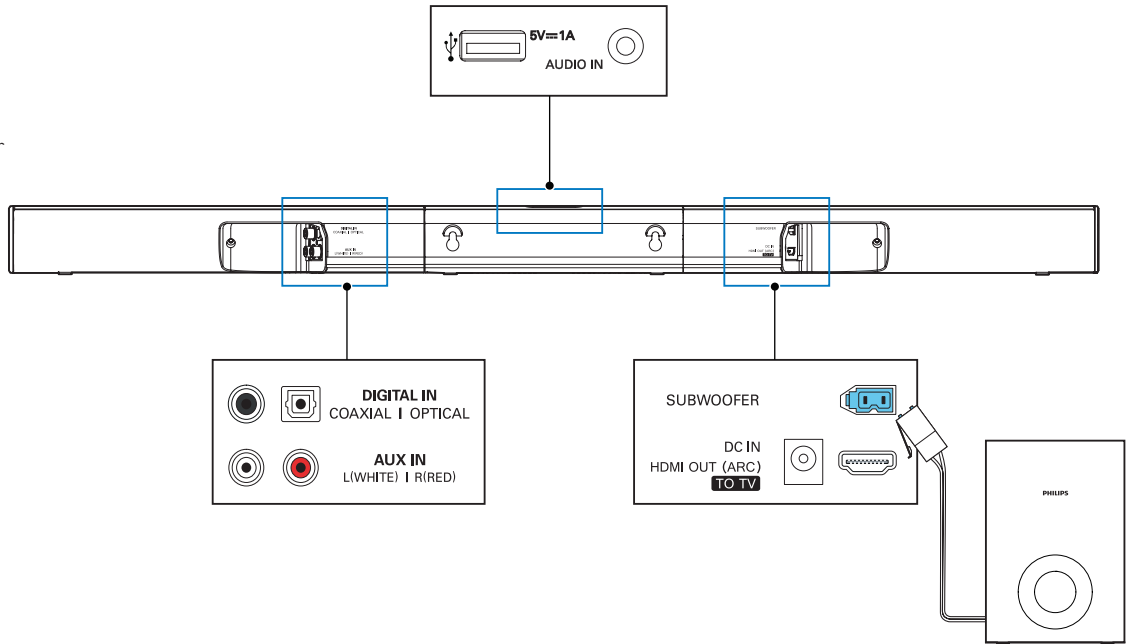

# 3

- EN** Hear audio from TV in one of the following ways
- ES** Escuche el audio del televisor de una de las siguientes formas
- FR-CA** Vous pouvez diffuser l'audio du téléviseur des façons suivantes

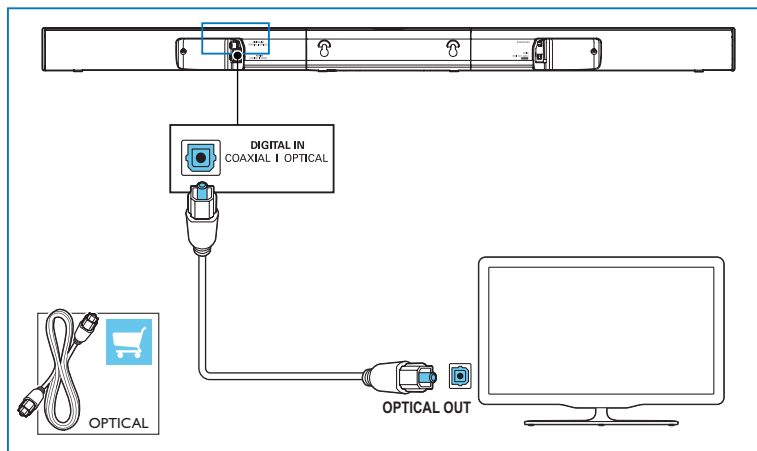
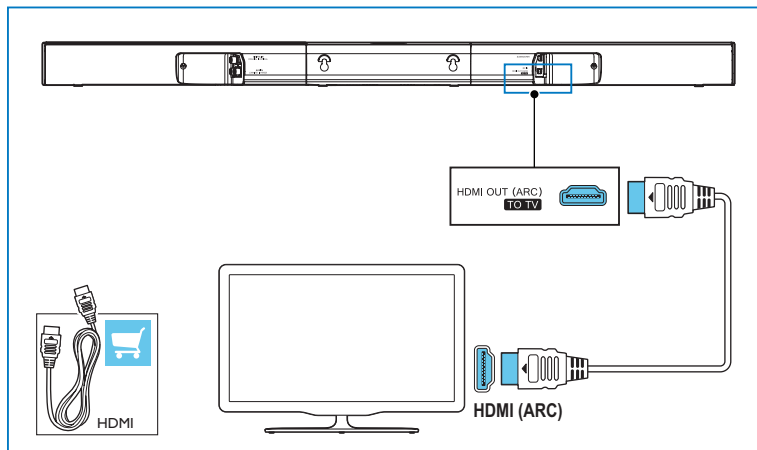

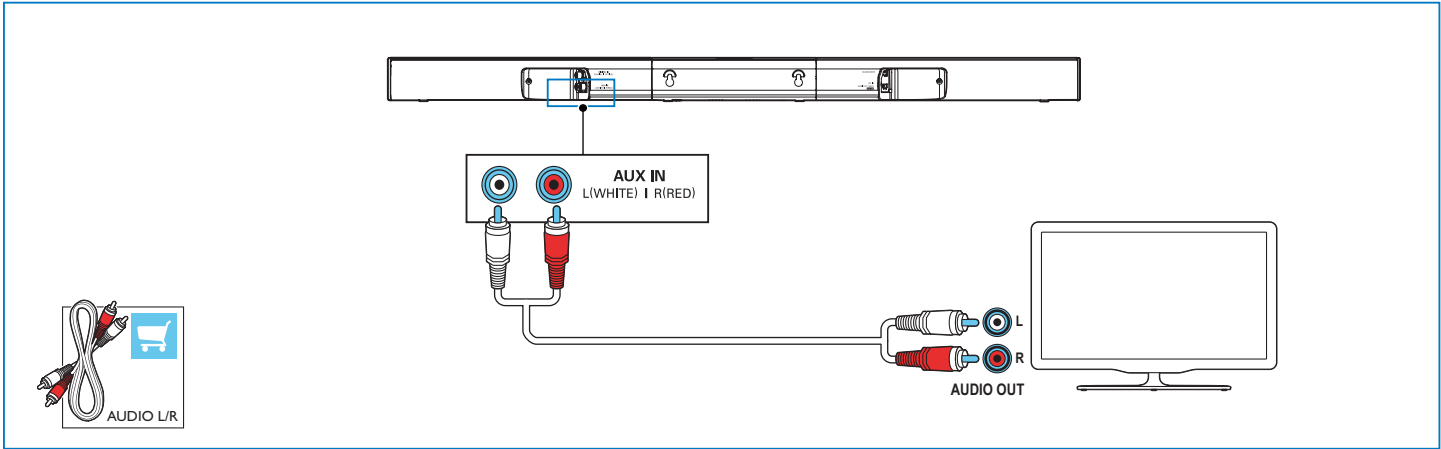
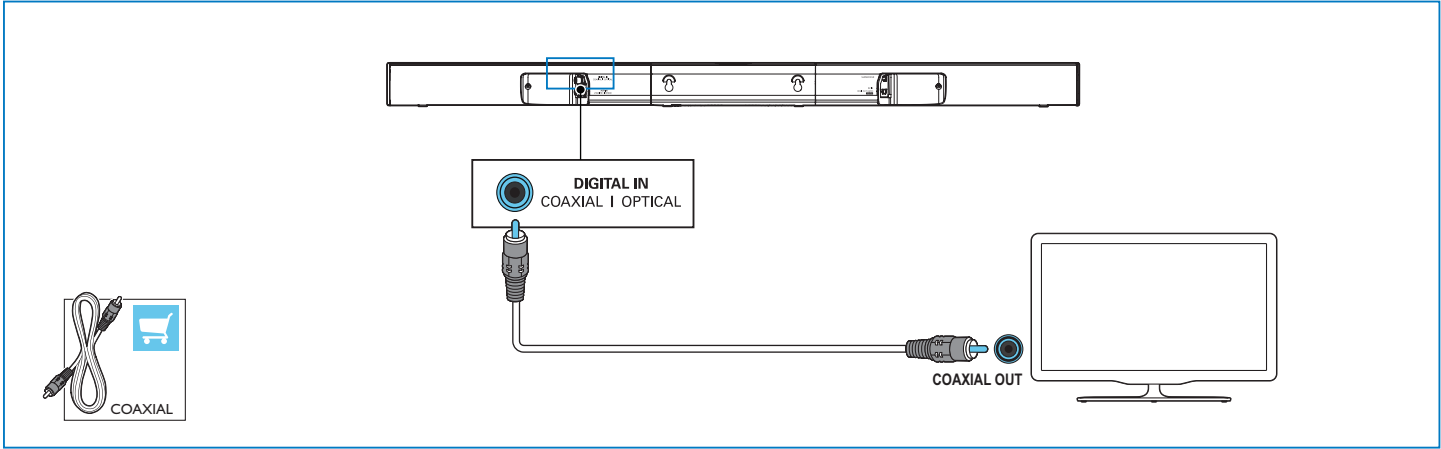



# 4

**EN** Switch on the SoundBar

**ES** Encendido del SoundBar

**FR-CA** Allumez le SoundBar

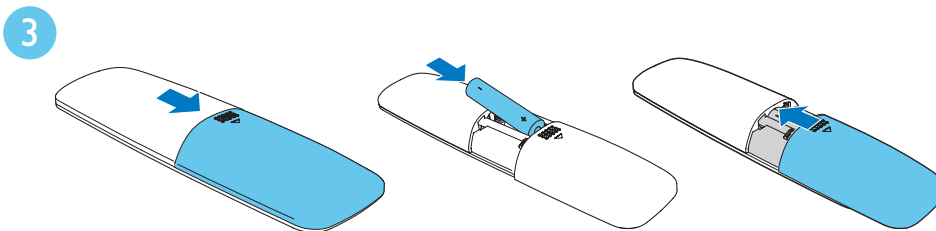
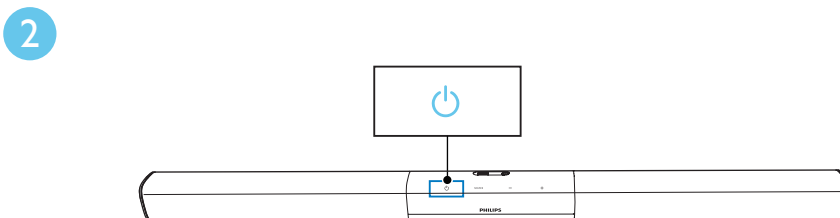
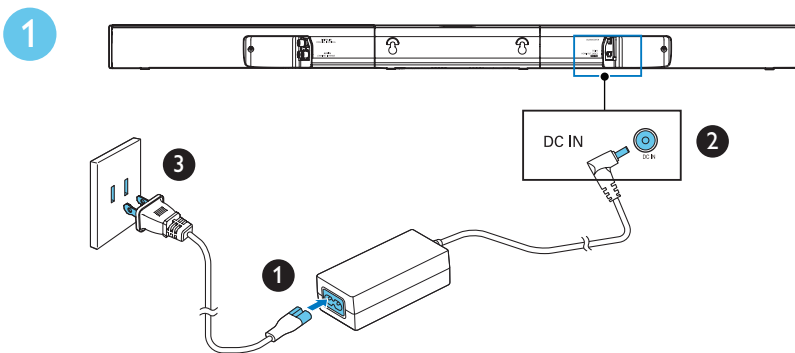

# 5

- EN** Select the correct audio source
- ES** Selección de la fuente de audio correcta
- FR-CA** Sélectionnez la source audio appropriée

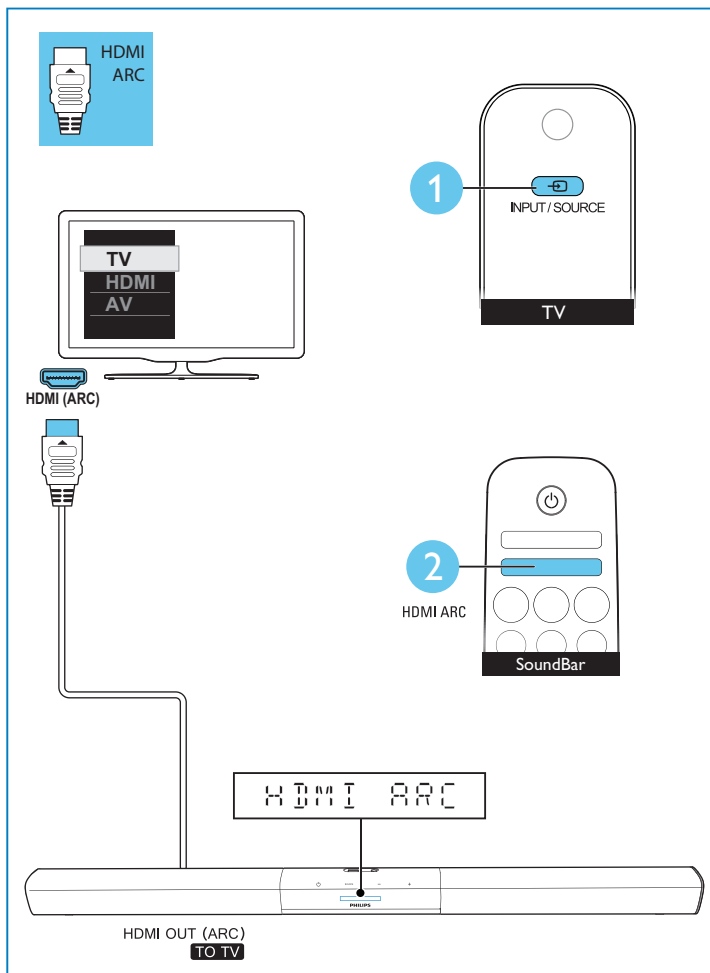

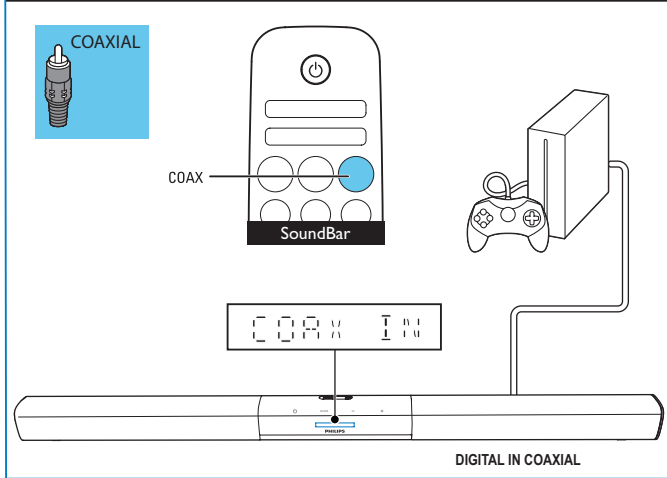
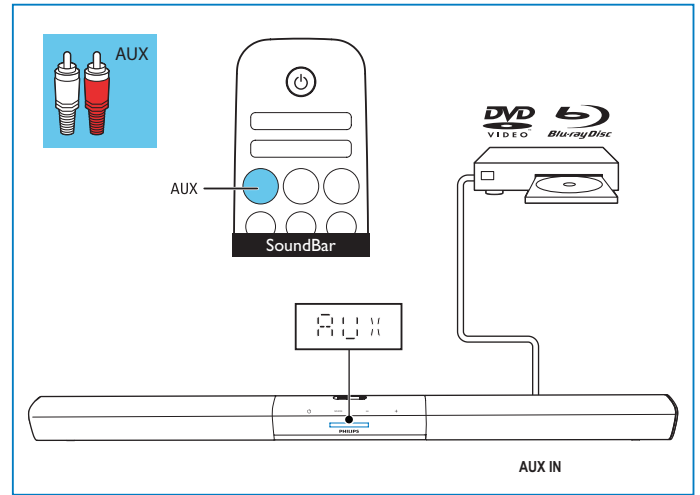
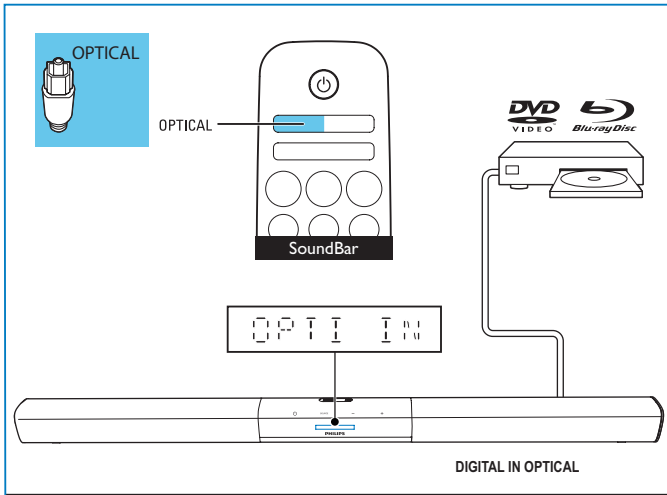

# 6

- EN** Play other devices
- ES** Reproducción de otros dispositivos
- FR-CA** Lisez le contenu d'autres appareils

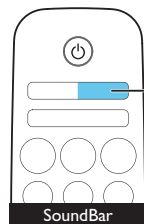

3  
AUDIO IN

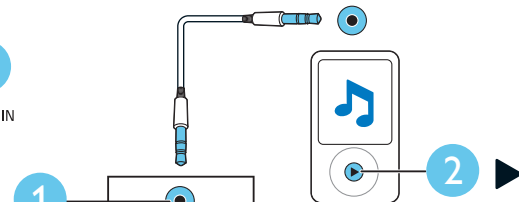

1



AUDIO IN

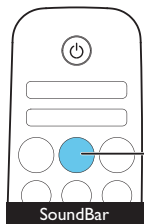
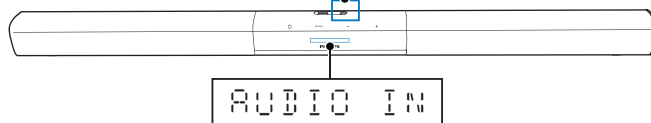

2  
USB

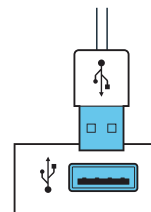

1

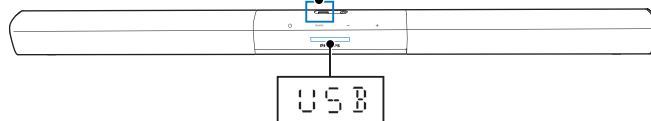

- EN** Cable management
- ES** Administración de cables
- FR-CA** Gestion des câbles

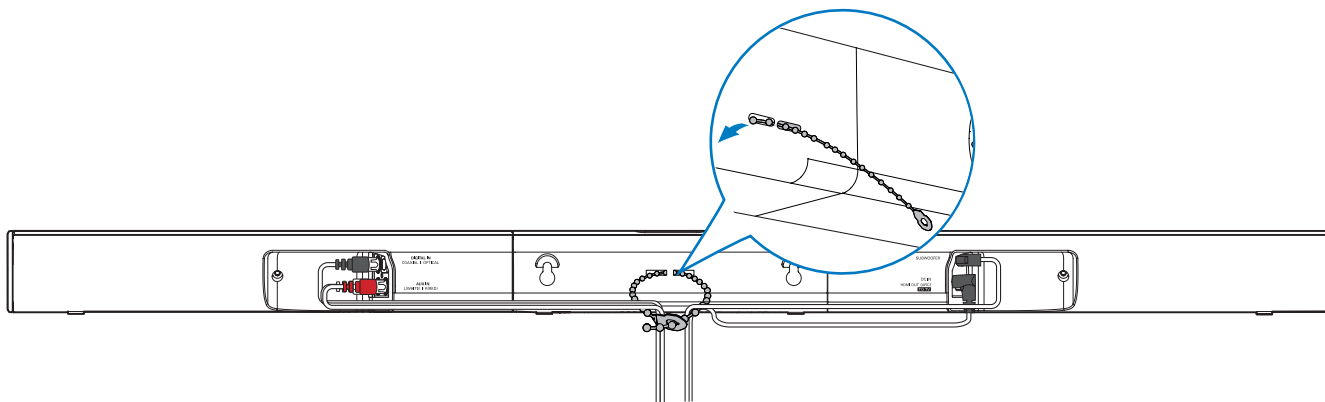



**EN** For more information about using this product, visit [www.philips.com/support](http://www.philips.com/support)

**ES** Para obtener más información sobre este producto, visite [www.philips.com/support](http://www.philips.com/support)

**FR-CA** Pour en savoir plus sur l'utilisation de ce produit, visitez le site [www.philips.com/support](http://www.philips.com/support)



[www.philips.com/support](http://www.philips.com/support)



Manufactured under license from Dolby Laboratories. Dolby and the double-D symbol are trademarks of Dolby Laboratories.



The terms HDMI and HDMI High-Definition Multimedia Interface, and the HDMI Logo are trademarks or registered trademarks of HDMI Licensing LLC in the United States and other countries.

P&F USA, Inc.  
PO Box 2248 Alpharetta, GA 30023-2248



Specifications are subject to change without notice

2015 © Gibson Innovations Limited. All rights reserved.

This product has been manufactured by, and is sold under the responsibility of Gibson Innovations Ltd., and Gibson Innovations Ltd. is the warrantor in relation to this product. Philips and the Philips Shield Emblem are registered trademarks of Koninklijke Philips N.V. and are used under license from Koninklijke Philips N.V.

HTL2153B\_F7\_QSG\_V3.0

