

Always there to help you

HTD5540

Register your product and get support at
www.philips.com/welcome



Quick start guide

PHILIPS



EN Before using your product, read all accompanying safety information

DA Læs alle medfølgende sikkerhedsoplysninger, inden du tager produktet i brug

DE Lesen Sie vor Verwendung dieses Produkts alle begleitenden Sicherheitsinformationen

EL Πριν χρησιμοποιήσετε το προϊόν, διαβάστε όλες τις παρεχόμενες πληροφορίες ασφάλειας

ES Antes de usar el producto, lea toda la información de seguridad adjunta

FI Lue kaikki turvallisuustiedot ennen tuotteen käyttöä

FR Avant d'utiliser votre produit, lisez l'intégralité des consignes de sécurité jointes

IT Prima di utilizzare il prodotto, leggere tutte le relative informazioni sulla sicurezza

NL Lees voordat u het product gaat gebruiken eerst alle bijbehorende veiligheidsinformatie

NO Les all vedlagt sikkerhetsinformasjon før du bruker produktet

PT Antes de utilizar o produto, leia todas as informações de segurança que o acompanham

SV Innan du använder produkten ska du läsa all tillhörande säkerhetsinformation

TR Ürününüzü kullanmadan önce ilgili tüm güvenlik bilgilerini okuyun

CS Před použitím produktu si přečtěte doprovodné bezpečnostní informace

HU A termék használatá előtt alaposan olvassa el a mellékelt biztonsági tudnivalókat

PL Przed rozpoczęciem korzystania z produktu należy zapoznać się z informacjami dotyczącymi bezpieczeństwa

RO Înainte de a utiliza acest produs, citiți toate informațiile de siguranță care îl însoțesc

SK Pred použitím produktu si prečítajte všetky sprievodné bezpečnostné informácie

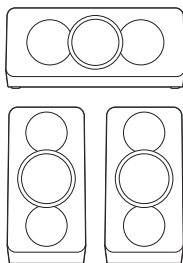
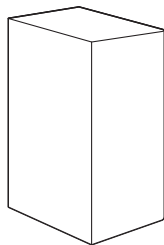
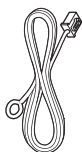
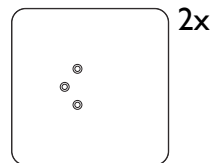
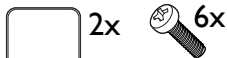
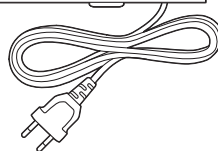
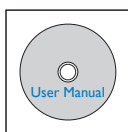
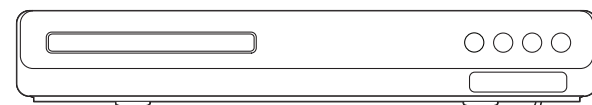
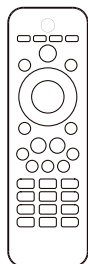
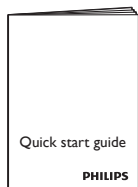
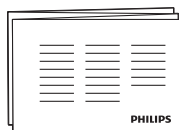

1

EN Stand mount the speakers

CS Nainstalujte reproduktory

DA Monter højttalerne på fod

DE Montage der Lautsprecher auf den Standfüßen

EL Στήστε τα ηχεία πάνω στις βάσεις

ES Monta los altavoces en la pared

FI Kaiuttimien kiinnitys jalustaan

FR Monter le pied des enceintes

HU A hangsugárázó állványra szerelése

IT Montaggio degli altoparlanti su supporto

NL Monteer de luidsprekers op de standaard

NO Montere høyttalerne på stativ

PL Montaż głośników na podstawie

PT Colocar os altifalantes no suporte

RO Montați pe suport boxe

SK Montáž reproduktorov na stojan

SV Montera högtalarna på stativ

TR Hoparlörleri kaideye monte edin

1

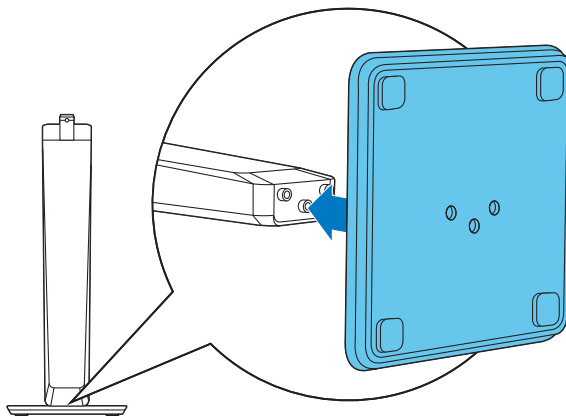

2

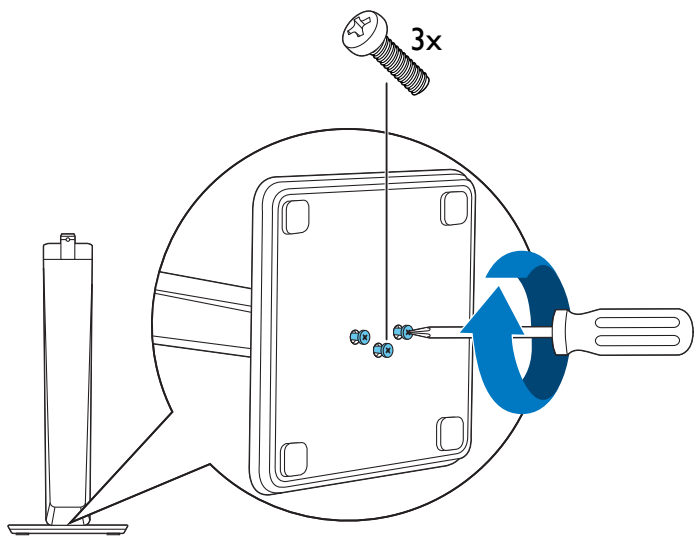

3

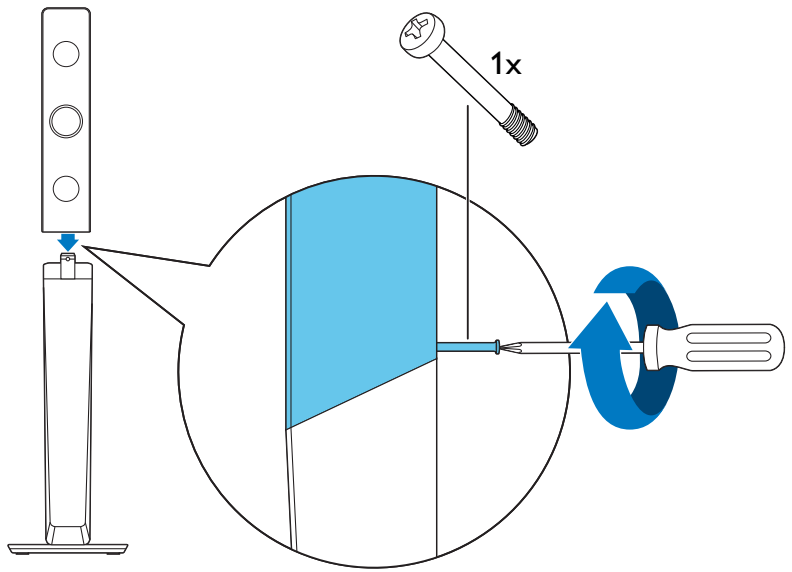

2

- EN** Connect the home theater
- DA** Tilslut hjemmebiografen
- DE** Anschließen des Home Entertainment-Systems
- EL** Συνδέστε το home cinema
- ES** Conecta el sistema de cine en casa
- FI** Kotiteatterin liittänyt
- FR** Connecter les enceintes au Home Cinéma
- IT** Collegamento del sistema Home Theater
- NL** Sluit de home cinema aan

- NO** Koble til hjemmekinoanlegget
- PT** Efectuar as ligações ao sistema de cinema em casa
- SV** Anslut hemmabiosystemet
- TR** Ev sinemasını bağlayın
- CS** Připojte domácí kino
- HU** A házimozi csatlakoztatása
- PL** Podłączenie zestawu kina domowego
- RO** Conectați sistemul home theater
- SK** Pripojenie k domácemu kinu

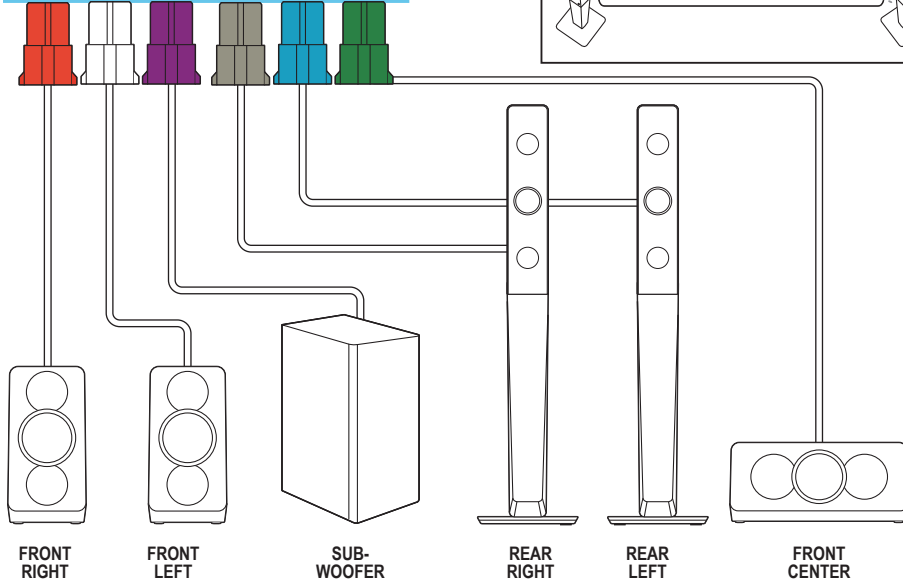
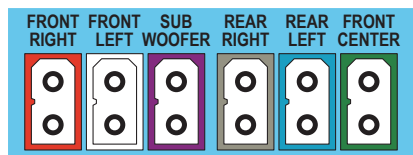
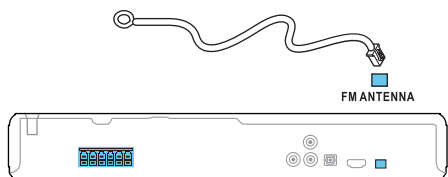

3

EN Connect to TV in one of these ways

DA Tilslut til TV på en af følgende måder

DE Herstellen einer Verbindung mit dem Fernseher über einer dieser Möglichkeiten

EL Συνδεθείτε στην τηλεόραση με έναν από τους παρακάτω τρόπους

ES Conexión al televisor de una de estas maneras

FI Liitä televisioon jommallakummalla tavalla

FR Connectez-vous au téléviseur via l'une de ces méthodes

IT Esegui il collegamento al TV in uno dei modi indicati di seguito

NL Maak op een van de volgende manieren verbinding met de TV

NO Koble til TV'en på en av følgende måter

PT Ligar ao televisor de uma destas formas

SV Anslut till TV:n på något av följande sätt

TR Aşağıdaki yöntemlerden biriyle TV'ye bağlanın

CS Připojení k televizoru proveďte jedním z následujících způsobů

HU Csatlakoztassa a tv-készülékhez az alábbi módok egyike szerint

PL Podłącz do telewizora przy użyciu jednej z tych metod

RO Conectați-vă la televizor într-unul din aceste moduri

SK Pripojte zariadenie k televízoru jedným z týchto spôsobov

HDMI ARC



HDMI OUT (ARC)

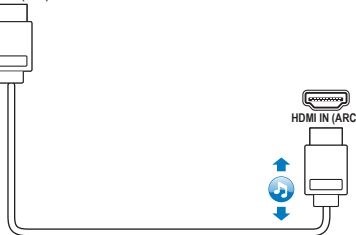

HDMI IN (ARC)



HDMI

HDMI + OPTICAL

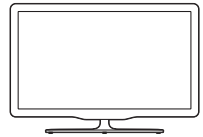
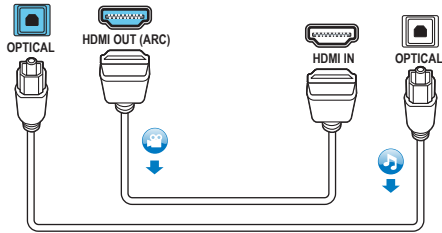

VIDEO + AUDIO L/R

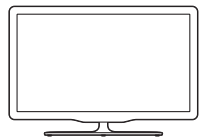
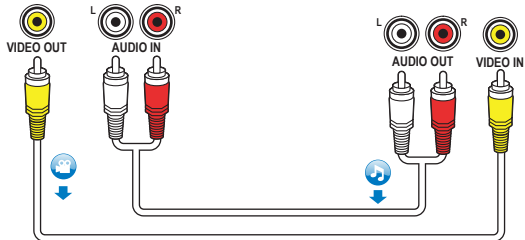

4

EN Switch on the home theater

DA Tænd for hjemmebiografen

DE Einschalten des Home Entertainment-Systems

EL Ενεργοποιήστε το home cinema

ES Enciende el sistema de cine en casa

FI Virran kytkeminen kotiteatteriin

FR Mettre sous tension le Home Cinéma

IT Accensione del sistema Home Theater

NL Schakel de home cinema in

NO Slå på hjemmekinoanlegget

PT Ligar o sistema de cinema em casa

SV Sätt på hemmabiosystemet

TR Ev sinemasini açın

CS Zapněte domácí kino

HU A házimozi bekapcsolása

PL Włączanie zestawu kina domowego

RO Porniți sistemul home theater

SK Zapnutie domáceho kina

1

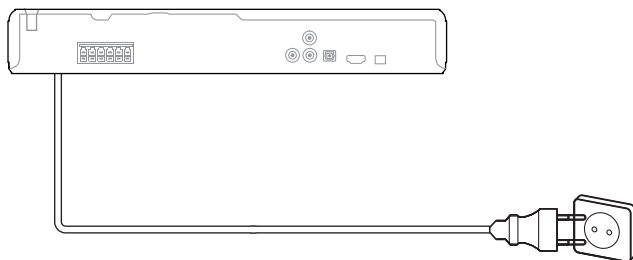

2

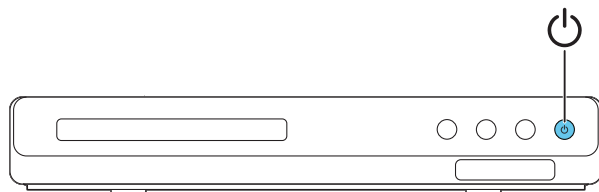

3

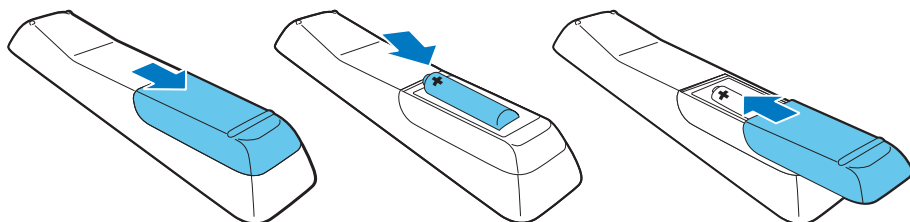

5

EN Complete the first time setup

DA Fuldfør den indledende opsætning

DE Abschließen der Ersteinrichtung

EL Ολοκληρώστε τη ρύθμιση για πρώτη φορά

ES Finaliza la configuración inicial

FI Ensiasennuksen suorittaminen loppuun

FR Effectuer la configuration initiale

IT Completamento della configurazione iniziale

NL Volttooi de eerste installatie

NO Fullføre den første konfigureringen

PT Executar a configuração inicial

SV Slutför förstagångsinställningen

TR İlk kullanim öncesi kurulumunu tamamlayın

CS Dokončíte jste nastavení při prvním zapnutí

HU Az első üzembe helyezés

PL Pierwsza konfiguracja

RO Realizați prima configurare

SK Dokončenie prvého nastavenia

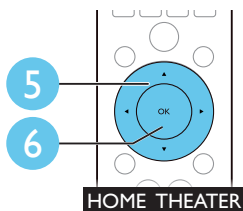
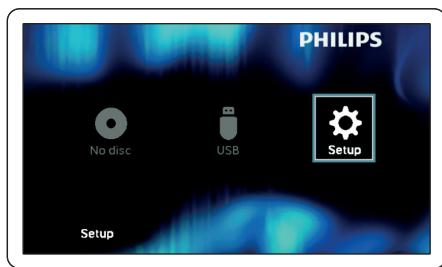
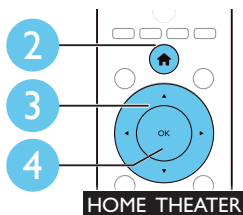
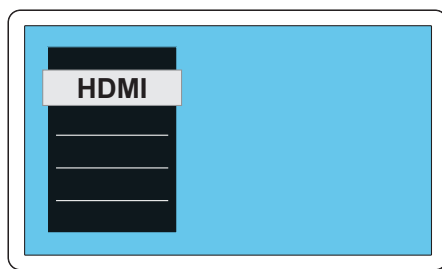
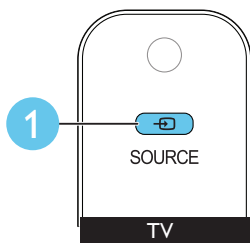

6

EN Use your home theater

DA Brug af din hjemmebiograf

DE Verwenden des Home Entertainment-Systems

EL Χρησιμοποιήστε το home cinema

ES Uso del sistema de cine en casa

FI Kotiteatterin käyttäminen

FR Utiliser votre Home Cinéma

IT Utilizzo del sistema Home Theater

NL Uw home cinema bedienen

NO Bruke hjemmekinoanlegget

PT Utilizar o sistema de cinema em casa

SV Använda hemmabiosystemet

TR Ev sinema sisteminin kullanılması

CS Použití domácího kina

HU A házimozí használata

PL Korzystanie z zestawu kina domowego

RO Utilizați sistemul home theater

SK Používanie domáceho kina

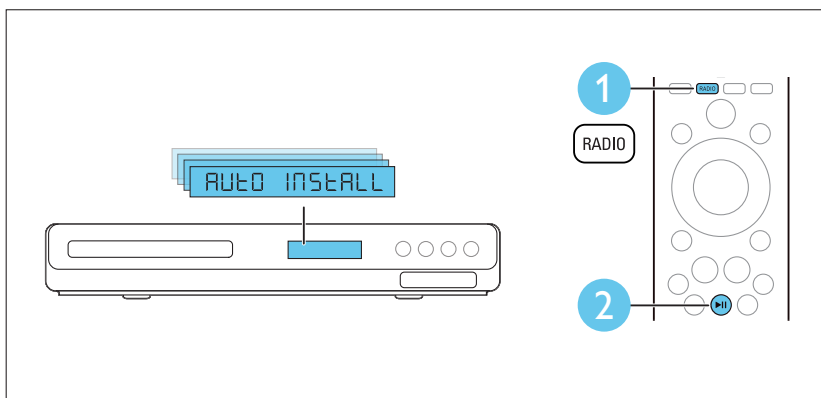
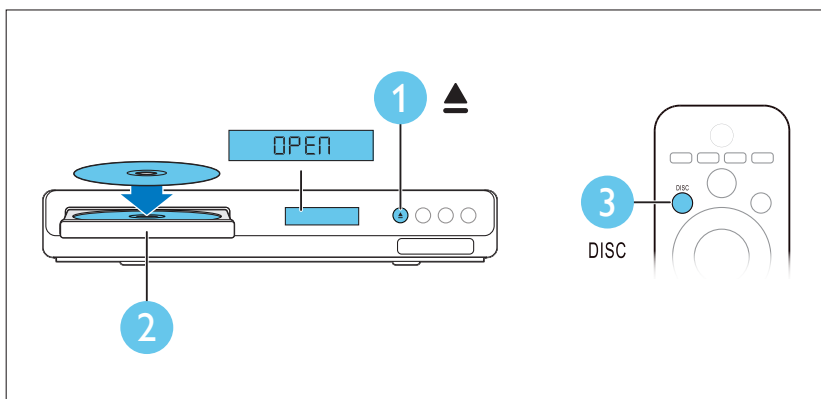

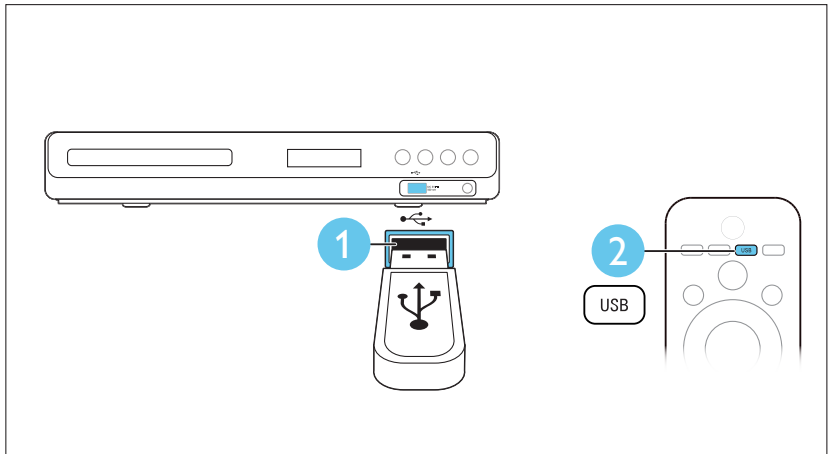
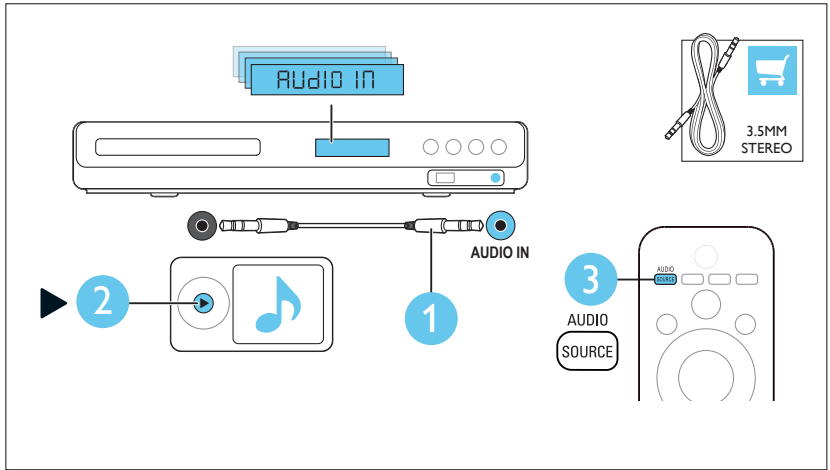

Specifications are subject to change without notice
© 2013 Koninklijke Philips Electronics N.V.
All rights reserved.

HTD5540_12_QSG_V1.0

