

DVD VIDEO PLAYER

DVP3005

User manual

Thank you for choosing Philips.

Need help fast?

Read your User's Manual first for quick tips that make using your Philips product more enjoyable.

If you have read your instructions and still need assistance, you may access our online help at www.philips.com/support

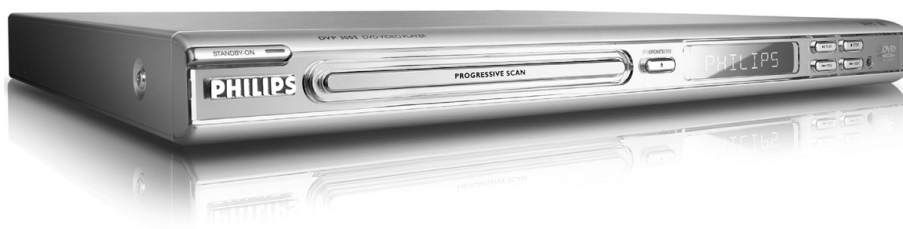

PHILIPS

Important notes for users in the U.K.

Mains plug

This apparatus is fitted with an approved 13 Amp plug. To change a fuse in this type of plug proceed as follows:

- 1 Remove fuse cover and fuse.
- 2 Fix new fuse which should be a BS1362 5 Amp, A.S.T.A. or BSI approved type.
- 3 Refit the fuse cover.

If the fitted plug is not suitable for your jack outlets, it should be cut off and an appropriate plug fitted in its place.

If the mains plug contains a fuse, this should have a value of 5 Amp. If a plug without a fuse is used, the fuse at the distribution board should not be greater than 5 Amp.

Note: The severed plug must be disposed to avoid a possible shock hazard should it be inserted into a 13 Amp jack elsewhere.

How to connect a plug

The wires in the mains lead are coloured with the following code: blue = neutral (N), brown = live (L).

- As these colours may not correspond with the colour markings identifying the terminals in your plug, proceed as follows:
 - Connect the blue wire to the terminal marked N or coloured black.
 - Connect the brown wire to the terminal marked L or coloured red.
 - Do not connect either wire to the earth terminal in the plug, marked E (or \perp) or coloured green (or green and yellow).

Before replacing the plug cover, make certain that the cord grip is clamped over the sheath of the lead - not simply over the two wires.

Copyright in the U.K.

Recording and playback of material may require consent. See Copyright Act 1956 and The Performer's Protection Acts 1958 to 1972.

CAUTION

Use of controls or adjustments or performance of procedures other than herein may result in hazardous radiation exposure or other unsafe operation.

VAROITUS

Muiden kuin tässä esitettyjen toimintojen säädön tai asetusten muutto saattaa altistaa vaaralliselle säteilylle tai muille vaarallisille toiminnoille.

CAUTION

VISIBLE AND INVISIBLE LASER RADIATION WHEN OPEN. AVOID EXPOSURE TO BEAM.

ADVARSEL

SYNLIG OG USYNLIG LASERSTRÅLING VED ÅBNING
UNDGÅ UDSÆTTELSE FOR STRÅLING
VARNING

SYNLIG OCH OSYNLIG

LASERSTRÅLNING NÅR DENNA DEL
ÄR ÖPPNAD BETRakta EJ STRÅLEN
VARO!

AVATTAESSA OLET ALTTIINA
NÄKYVÄLLE JA NÄKYMÄTTÖMÄLLE
LASER SÄTEILYLLE. ÄLÄ KATSO
SÄTEESEEN

VORSICHT

GEFAHR VON SICHTBARER UND
UNSICHTBARER LASERSTRAHLUNG
BEI GEÖFFNETEM GEHÄUSE.

ATTENTION

RAYONNEMENT LASER VISIBLE ET
INVISIBLE EN CAS D'OUVERTURE
EXPOSITION DANGEREUSE AU
FAISCEAU

CE This compact DVD player is in conformity with the EMC directive and low-voltage directive.

The apparatus shall not be exposed to dripping or splashing and that no objects filled with liquids, such as vases, shall be placed on apparatus.

Index

DK

Advarsel: Usynlig laserstråling ved åbning når sikkerhedsafbrydere er ude af funktion. Undgå udsættelse for stråling.

Bemærk: Netafbryderen er sekundært indkoblet og afbryder ikke strømmen fra nettet. Den indbyggede netdel er derfor tilsluttet til lysnettet så længe netstikket sidder i stikkontakten.

S

Klass 1 laserapparat

Varning! Om apparaten används på annat sätt än i denna bruksanvisning specificerats, kan användaren utsättas för osynlig laserstrålning, som överskrider gränsen för laserklass 1.

Observera! Stömbrytaren är sekundärt kopplad och bryter inte strömmen från nätet. Den inbyggda nätdelen är därför ansluten till elnätet så länge stickproppen sitter i vägguttaget.

SF

Luokan 1 laserlaite

Varoitus! Laitteen käyttäminen muulla kuin tässä käyttöohjeessa mainitulla tavalla saattaa altistaa käyttäjän turvallisuusluokan 1 ylittävälle näkymättömälle lasersäteilylle.

Oikeus muutoksiin varataan. Laite ei saa olla alttiina tippu- ja roiskevedelle.

Huom. Toiminnanvalitsin on kytketty toisiopuolelle, eikä se kytke laitetta irti sähköverkosta. Sisäänrakennettu verkko-osa on kytkettyinä sähköverkkoon aina silloin, kun pistoke on pistorasiassa.

English 6

Français 34

Deutsch 62

Nederlands 90

English

Français

Deutsch

Nederlands

Due to the inconsistency of disc formats provided by various disc manufacturers, your DVD system may require a playability enhancement or upgrade. As DVD technology advances, these enhancements will become common and will be easy to complete.
Go to www.philips.com/support for software upgrade.

General Information

Environmental Information

All unnecessary packaging has been omitted. The packaging has been made easy to separate into two materials: cardboard (box, buffer) and polyethylene (bags, protective foam sheet).

Your DVD player consists of materials which can be recycled and reused if disassembled by a specialised company. Please observe the local regulations regarding the disposal of packaging materials, exhausted batteries and old equipment.

This product incorporates copyright protection technology that is protected by method claims of certain U.S. patents and other intellectual property rights owned by Macrovision Corporation and other rights owners. Use of this copyright protection technology must be authorized by Macrovision Corporation, and is intended for home and other limited viewing uses only unless otherwise authorized by Macrovision Corporation. Reverse engineering or disassembly is prohibited.

Manufactured under license from Dolby Laboratories. "Dolby", "Pro Logic" and the double-D symbol are trademarks of Dolby Laboratories.

For Customer Use:

Read carefully the information located at the rear/bottom of your DVD VIDEO player and enter below the Serial No. Retain this information for future reference.

Model No. DVP 3005

Serial No. _____

Laser safety

This unit employs a laser. Due to possible eye injury, only a qualified service person should remove the cover or attempt to service this device.

NOTE:
PICTURES SHOWN MAYBE DIFFERENT BETWEEN COUNTRIES.

CAUTION
(WARNING LOCATION: ON THE BACKPLATE OF THE SET)

NEVER MAKE OR CHANGE CONNECTIONS WITH THE POWER SWITCHED ON.

Specifications are subject to change without notice. Trademarks are the property of Koninklijke Philips Electronics N.V. or their respective owners.

'CONSUMERS SHOULD NOTE THAT NOT ALL HIGH DEFINITION TELEVISION SETS ARE FULLY COMPATIBLE WITH THIS PRODUCT AND MAY CAUSE ARTIFACTS TO BE DISPLAYED IN THE PICTURE. IN CASE OF 525 OR 625 PROGRESSIVE SCAN PICTURE PROBLEMS, IT IS RECOMMENDED THAT THE USER SWITCH THE CONNECTION TO THE 'STANDARD DEFINITION' OUTPUT. IF THERE ARE QUESTIONS REGARDING OUR TV SET COMPATIBILITY WITH THIS MODEL 525p AND 625p DVD PLAYER, PLEASE CONTACT OUR CUSTOMER SERVICE CENTER.'

LASER

Type	Semiconductor laser GaAlAs
Wave length	650 nm (DVD) 780 nm (VCD/CD)
Output Power	7 mW (DVD) 10 mW (VCD/CD)
Beam divergence	60 degree

Language Code

Abkhazian	6566	Inupiaq	7375	Pushto	8083
Afar	6565	Irish	7165	Russian	8285
Afrikaans	6570	Íslenska	7383	Quechua	8185
Amharic	6577	Italiano	7384	Raeto-Romance	8277
Arabic	6582	Ivrit	7269	Romanian	8279
Armenian	7289	Japanese	7465	Rundi	8278
Assamese	6583	Javanese	7486	Samoan	8377
Avestan	6569	Kalaallisut	7576	Sango	8371
Aymara	6589	Kannada	7578	Sanskrit	8365
Azerhijani	6590	Kashmiri	7583	Sardinian	8367
Bahasa Melayu	7783	Kazakh	7575	Serbian	8382
Bashkir	6665	Kernewek	7587	Shona	8378
Belarusian	6669	Khmer	7577	Shqip	8381
Bengali	6678	Kinyarwanda	8287	Sindhi	8368
Bihari	6672	Kirghiz	7589	Sinhalese	8373
Bislama	6673	Komi	7586	Slovensky	8373
Bokmål, Norwegian	7866	Korean	7579	Slovenian	8376
Bosanski	6683	Kuanyama; Kwanyama	7574	Somali	8379
Brezhoneg	6682	Kurdish	7585	Sotho; Southern	8384
Bulgarian	6671	Lao	7679	South Ndebele	7882
Burmese	7789	Latina	7665	Sundanese	8385
Castellano, Español	6983	Latvian	7686	Suomi	7073
Catalán	6765	Letzeburgesch;	7666	Swahili	8387
Chamorro	6772	Macedonian	7673	Swati	8383
Chechen	6769	Limburch; Limburger	7673	Svenska	8386
Chewa; Chichewa; Nyanja	7889	Lingala	7678	Tagalog	8476
中文	9072	Lithuanian	7684	Tahitian	8489
Chuang; Zhuang	9065	Luxembourgish;	7666	Tajik	8471
Church Slav; Slavonic	6785	Macedonian	7775	Tamil	8465
Chuvash	6786	Malagasy	7771	Tatar	8484
Corsican	6779	Magyar	7285	Telugu	8469
Česky	6783	Malayalam	7776	Thai	8472
Dansk	6865	Maltese	7784	Tibetan	6679
Deutsch	6869	Manx	7186	Tigrinya	8473
Dzongkha	6890	Maori	7773	Tonga (Tonga Islands)	8479
English	6978	Marathi	7782	Tsonga	8483
Esperanto	6979	Marshallese	7772	Tswana	8478
Estonian	6984	Moldavian	7779	Türkçe	8482
Euskara	6985	Mongolian	7778	Turkmen	8475
Ελληνικά	6976	Nauru	7865	Twi	8487
Faroese	7079	Navaho; Navajo	7886	Uighur	8571
Français	7082	Ndebele, North	7868	Ukrainian	8575
Frysk	7089	Ndebele, South	7882	Urdu	8582
Fijian	7074	Ndonga	7871	Uzbek	8590
Gaelic; Scottish Gaelic	7168	Nederlands	7876	Vietnamese	8673
Gallegan	7176	Nepali	7869	Volapuk	8679
Georgian	7565	Norsk	7879	Walloon	8765
Gikuyu; Kikuyu	7573	Northern Sami	8369	Welsh	6789
Guarani	7178	North Ndebele	7868	Wolof	8779
Gujarati	7185	Norwegian Nynorsk;	7878	Xhosa	8872
Hausa	7265	Occitan; Provençal	7967	Yiddish	8973
Herero	7290	Old Bulgarian; Old Slavonic	6785	Yoruba	8979
Hindi	7273	Oriya	7982	Zulu	9085
Hiri Motu	7279	Oromo	7977		
Hrvatski	6779	Ossetian; Ossetic	7983		
Ido	7379	Pali	8073		
Interlingua (International)	7365	Panjabi	8065		
Interlingue	7365	Persian	7065		
Inuktitut	7385	Polski	8076		
		Português	8084		

Contents

Language Code 5

Introduction

Supplied accessories	8
Care and safety information	8

Connections

Connecting TV	9-10
Using SCART jack.....	9
Using Composite Video jacks (CVBS)	9
Using Component Video jacks (Pr Pb Y) .	10
Using an accessory RF modulator	10
Connecting the power cord	11
Optional: Connecting to an Audio System ...	12
Stereo system has Dolby Pro Logic or Right	
/ Left Audio In jack	12
Optional: Connecting Digital AV Receiver ...	12
Receiver has a PCM, Dolby Digital, or	
MPEG2 decoder	12

Functional Overview

Front and Rear Panels	13
Remote Control	14

Getting Started

Step 1: Inserting batteries into the	
Remote Control	15
Using the Remote Control to operate the	
Player	15
Step 2: Setting up the TV	15-17
Setting up Progressive Scan feature (for	
Progressive Scan TV only)	16
To deactivate Progressive manually	17
Selecting the colour system that	
corresponds to your TV	17
Step 3: Setting language preference	18
Setting the OSD Language	18
Setting the Audio, Subtitle and Disc menu	
language	18

Disc Operations

Playable Discs	19
Region Codes	19
Playing discs	19
Basic playback controls	20
Selecting various repeat/shuffle functions	20
Repeat play mode	20
Repeating a section within a chapter/track .	
.....	20
Operations for video playback	21
Using the Disc Menu	21
Zooming in	21
Resuming playback from the last stopped	
point	21
Slow motion	21
OSD (On-Screen Display)	21
Special DVD features	22
Playing a Title	22
Camera Angle	22
Changing the Audio Language	22
Subtitles	22
Special VCD & SVCD Features	22
Playback Control (PBC)	22
Playing MP3/JPEG (Kodak) Picture CD	23
General Operation	23
Playback selection	23
Repeat	23
Fast Forward/Reverse (MP3)	23

Contents

DVD Setup Menu Options	
General Setup menu	24
Dimming player's display panel	24
OSD Language	24
Sleep	24
Screen Saver - turning on/off	24
Audio Setup Menu	25
Setting the Downmix	25
Digital Audio Setup	25
Video Setup Menu	26-27
TV Type	26
Setting the TV Display	26
Progressive - turning on/off	27
Sharpness	27
Brightness/Contrast	27
Switching the YUV/RGB	27
Preference Page	28-29
Audio, Subtitle, Disc Menu	28
Restricting playback by Parental Control	28
Changing the Password	29
Restoring to original settings	29
Troubleshooting 30-31	
Specifications 32	
Glossary 33	

English

Introduction

Supplied accessories

Remote Control
and
two AA batteries

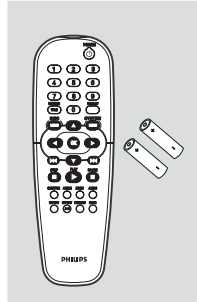

Care and safety information

- **Power consumption**
 - When the system is switched to Standby mode, it is still consuming power. To disconnect the system from the power supply completely, remove the AC power plug from the wall jack.
- **Avoid high temperatures, moisture, water and dust**
 - Do not expose the player, batteries or discs to humidity, rain, sand or excessive heat (caused by heating equipment or direct sunlight.)
- **Avoid condensation problem**
 - The lens may cloud over when the player is suddenly moved from cold to warm surroundings, making it impossible to play a disc. Leave the player in the warm environment until the moisture evaporates.
- **Do not block the vents**
 - Do not operate the DVD Player in an enclosed cabinet, allow about 10 cm (4 inches) of free space all around the player for adequate ventilation.

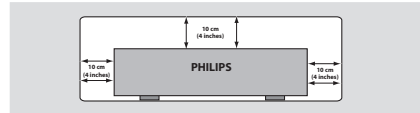

- **Care of the cabinet**
 - Use a soft cloth slightly moistened with a mild detergent solution. Do not use a solution containing alcohol, spirits, ammonia or abrasives.
- **Finding a suitable location**
 - Place the player on a flat, hard, and stable surface.
- **Disc handling**
 - To clean a CD, wipe it in a straight line from the center towards the edge using a soft, lint-free cloth. A cleaning agent may damage the disc!
 - Write only on the printed side of a CDR(W) and only with a soft felt-tipped pen.
 - Handle the disc by its edge, do not touch the surface.

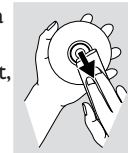

Connections

English

Connecting TV

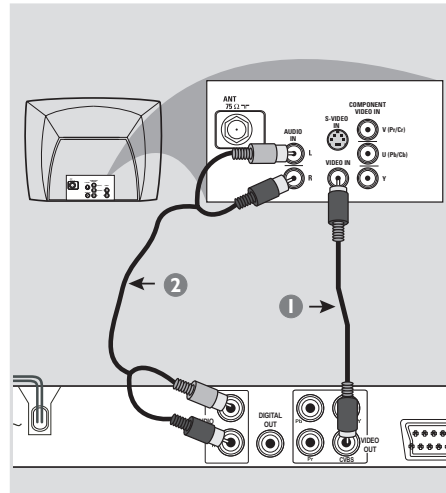
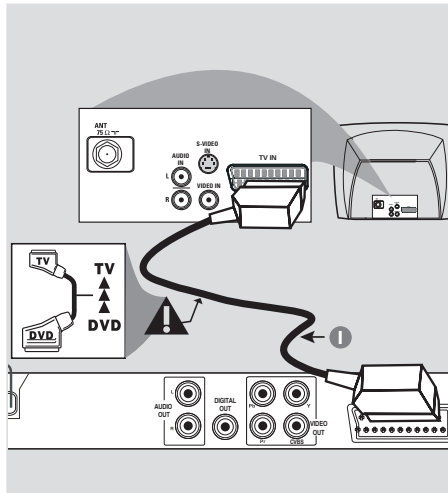

IMPORTANT!

- You only need to make one video connection from the following options, depending on the capabilities of your TV system.
- Connect the DVD Player directly to the TV.
- SCART connection will let you use the features of both the Audio and Video in the DVD Player.

Using SCART jack

- Use the SCART cable (black) to connect the DVD Player's SCART jack (**TV OUT**) to the corresponding Scart input jacks on the TV (*cable not supplied*).

Helpful Hint:

- Ensure that the “TV” indication on SCART cable is connected to the TV set and “DVD” indication on SCART cable is connected to the DVD Player.

Using Composite Video jacks (CVBS)

- 1 Use the composite video cable (yellow) to connect the DVD Player's CVBS (VIDEO) jack to the video input jack (or labeled as A/V In, Video In, Composite or Baseband) on the TV (*cable not supplied*).
- 2 To hear the sound of this DVD Player through your TV, use the audio cables (white/red) to connect AUDIO OUT (L/R) jacks of the DVD Player to the corresponding AUDIO IN jacks on the TV (*cable not supplied*).

Connections

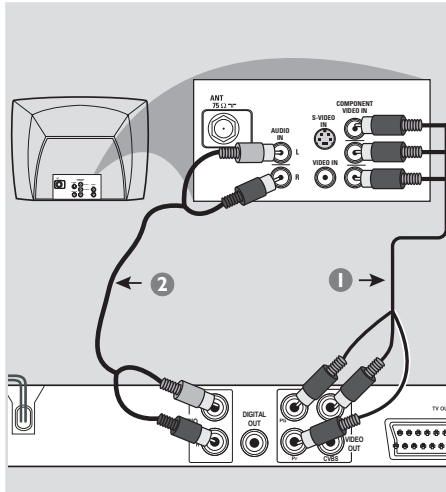

IMPORTANT!

- The progressive scan video quality is only possible when using **Y Pb Pr** and a progressive scan TV is required.

Using Component Video jacks (Y Pb Pr)

- 1 Use the component video cables (red/blue/green) to connect the DVD system's **Y Pb Pr** jacks to the corresponding Component video input jacks (or labeled as Y Pb Pr) on the TV (*cable not supplied*).
- 2 To hear the sound of this DVD Player through your TV, use the audio cables (white/red) to connect AUDIO OUT (L/R) jacks of the DVD Player to the corresponding AUDIO IN jacks on the TV (*cable not supplied*).
- 3 Proceed to page 16 for detailed Progressive Scan set up.

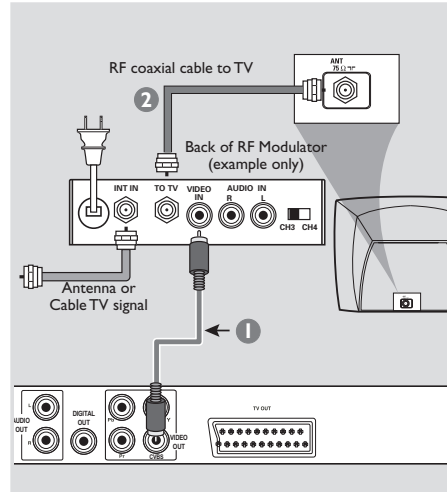

IMPORTANT!

- If your TV only has a single Antenna In jack (or labeled as 75 ohm or RF In,) you will need an RF modulator in order to view the DVD playback on the TV. See your electronics retailer or contact Philips for details on RF modulator availability and operations.

Using an accessory RF modulator

- 1 Use the composite video cable (yellow) to connect the DVD Player's **CVBS** jack to the video input jack on the RF modulator.
- 2 Use the RF coaxial cable (not supplied) to connect the RF modulator to your TV's RF jack.

Connections

English

Connecting the power cord

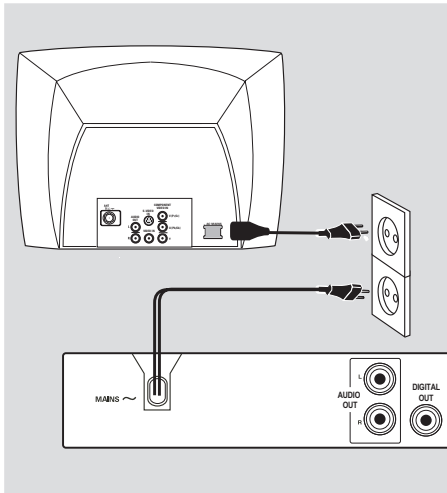

After everything is connected properly, plug in the AC power cord to the power outlet.

Never make or change any connections with the power switched on.

When no disc is loaded, press **STANDBY ON** on the DVD Player front panel, "NO DISC" may appear on the display panel.



Connections

Optional: Connecting to an Audio System

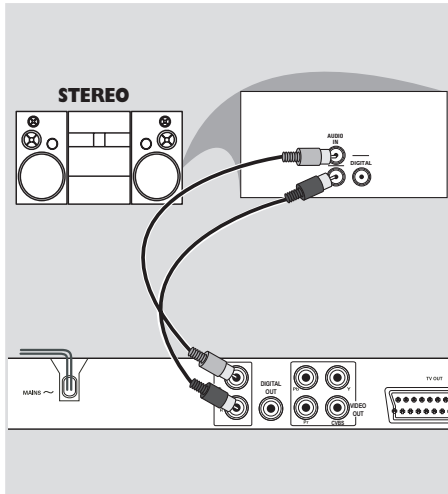

Stereo system has Dolby Pro Logic or Right / Left Audio In jack

- 1 Select one of the video connections (CVBSVIDEO IN or COMPONENT VIDEO IN) depending on the options available on your TV.
- 2 Use the audio cables (white/red) to connect **AUDIO OUT (L/R)** jacks of the DVD Player to the corresponding **AUDIO IN** jacks on the stereo system (cable not supplied).

Optional: Connecting Digital AV Receiver

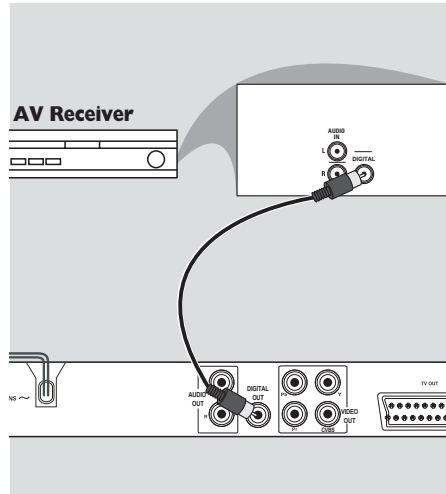

Receiver has a PCM, Dolby Digital, or MPEG2 decoder

- 1 Select one of the video connections (CVBSVIDEO IN or COMPONENT VIDEO IN) depending on the options available on your TV.
- 2 Connect the **COAXIAL** jack of the DVD Player to the corresponding Digital Audio In jack on your Receiver (cable not supplied).
- 3 Set the DVD Player's Digital Output to **PCM-ONLY** or **ALL** depending on the capabilities of your Receiver (see page 25 "Digital Output").

Helpful Hint:

- If the audio format of the Digital Output does not match the capabilities of your receiver, the receiver will produce a strong, distorted sound or no sound at all.

Functional Overview

English

Front and Rear Panels

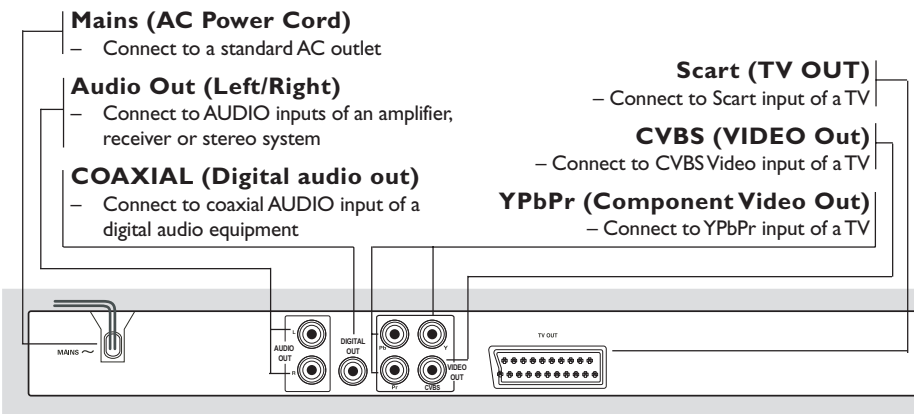
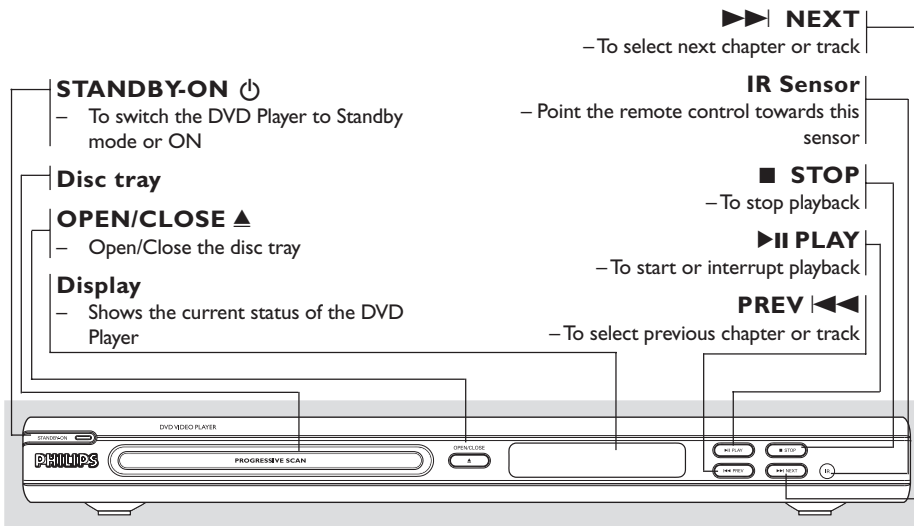

Caution: Do not touch the inner pins of the jacks on the rear panel. Electrostatic discharge may cause permanent damage to the unit.

Functional Overview

Remote Control

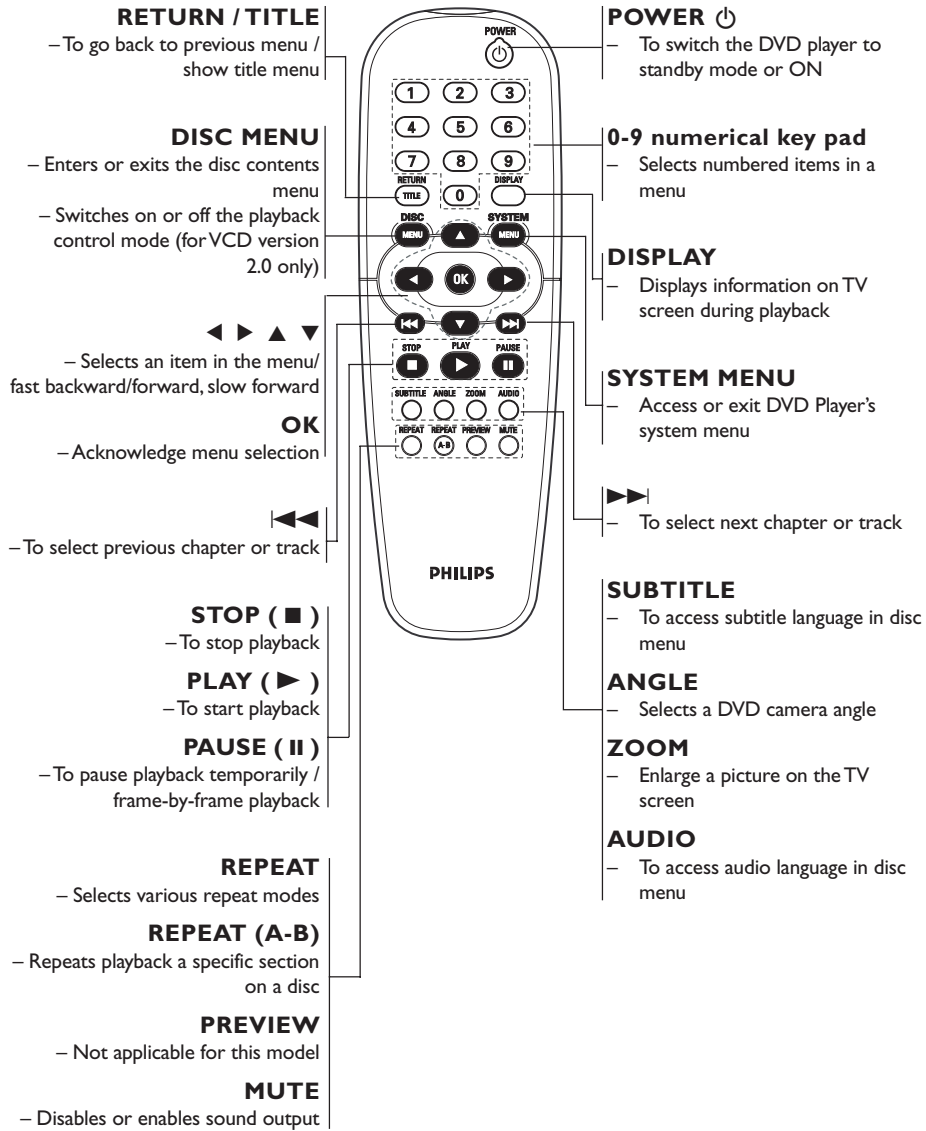

Getting Started

English

Step 1: Inserting batteries into the Remote Control

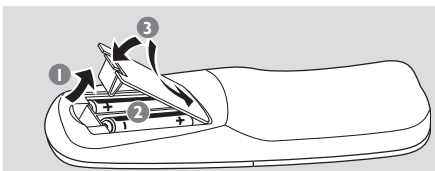

- 1 Open the battery compartment.
- 2 Insert two batteries type R06 or AA, following the indications (+ -) inside the compartment.
- 3 Close the cover.

Using the Remote Control to operate the Player

- 1 Aim the Remote Control directly at the remote sensor (IR) on the front panel.
- 2 Do not put any objects between the Remote Control and the DVD Player while operating the DVD Player.



CAUTION!

- Remove batteries if they are exhausted or if the Remote Control is not being used for a long time.
- Do not use old and new or different types of batteries in combination.
- Batteries contain chemical substances, so they should be disposed properly.

Step 2: Setting up the TV

IMPORTANT!

Make sure you have completed all the necessary connections. (See pages 9-10 "Connecting TV").

- 1 Turn on the TV and set to the correct video-in channel. You should see the Philips DVD background screen on the TV.
- 2 Usually these channels are between the lowest and highest channels and may be called FRONT, A/V IN, or VIDEO. See your TV manual for more details.
→ Or, you may go to channel 1 on your TV, then press the Channel down button repeatedly until you see the Video In channel.
→ Or, the TV Remote Control may have a button or switch that chooses different video modes.
→ Or, set the TV to channel 3 or 4 if you are using an RF modulator.
- 3 If you are using external equipment, (eg. audio system or receiver), turn it on and select the appropriate input source for the DVD Player output. Refer to the equipment owner's manual for detail.

Getting Started

Setting up Progressive Scan feature (for Progressive Scan TV only)

The progressive scan display twice the number of frames per seconds than interlaced scanning (ordinary normal TV system). With nearly double the number of lines, progressive scan offers higher picture resolution and quality.

IMPORTANT!

Before enabling the progressive scan feature, you must ensure:

- 1) Your TV can accept progressive signals, a progressive scan TV is required.
- 2) You have connected the DVD player to your TV using Y Pb Pr (see page 10.)

- 1 Turn on your TV.
- 2 Turn off your TV progressive scan mode or turn on interlaced mode (refer to your TV user manual.)
- 3 Press **POWER** on the remote control to turn on the DVD player.
- 4 Select the correct Video Input channel. (See page 15).
→ The DVD background screen appears on the TV.
- 5 Press **SYSTEM MENU**.
- 6 Press **▶** repeatedly to select {VIDEO SETUP PAGE}.

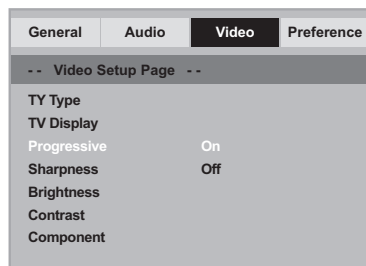

- 7 Select {COMPONENT} to {YUV}, then press **OK** to confirm.
- 8 Select {PROGRESSIVE} to {ON}, then **OK** to confirm.
→ The instruction menu appears on the TV.

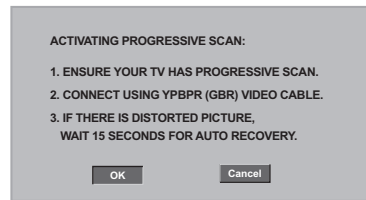

- 9 Press **◀** to highlight **OK** in the menu and press **OK** to confirm.

There will be a distorted picture on your TV at this state until you turn on the progressive scan mode on your TV.

- 10 Turn on your TV progressive scan mode (refer to your TV user manual.)
→ The below menu appears on the TV.

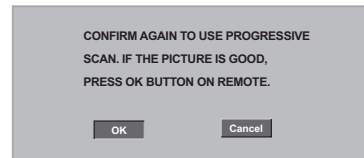

- 11 Press **◀** to highlight **OK** in the menu and press **OK** to confirm.
→ The set up is complete now and you can start enjoy the high quality picture.

TIPS: To return to the previous menu, press **◀**.
To remove the menu, press **SYSTEM MENU**.

Getting Started

To deactivate Progressive manually

- **When the distorted picture still appears on the TV**, it may be due to the connected TV does not accept progressive signals, and progressive is set by mistake. You must reset the unit to interlace format.
- ① **Turn off** your TV progressive scan mode or turn on to interlaced mode (refer to your TV user manual.)
- ② Press **OPEN/CLOSE** on the DVD player to open the disc tray.
- ③ Press **numeric keypad '1'** on the remote control for few seconds.
→ The DVD blue background screen will appear on the TV.

Selecting the colour system that corresponds to your TV

This DVD Player is compatible with both NTSC and PAL. In order for a DVD disc to play on this Player, the colour system of the Disc, the TV and the DVD Player should match.

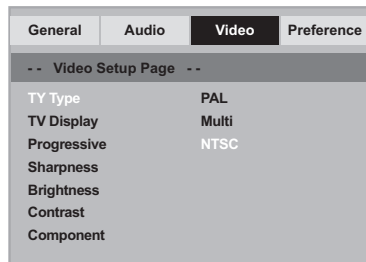

- ① Press **SYSTEM MENU**.
- ② Press **▶** repeatedly to select {VIDEO SETUP PAGE}.
- ③ Press **▲ ▼** to highlight {TV TYPE}, then press **▶**.

- ④ Press **▲ ▼** to highlight one of the options below:

PAL – Select this if the connected TV is PAL system. It will change the video signal of a NTSC disc and output in PAL format.

NTSC – Select this if the connected TV is NTSC system. It will change the video signal of a PAL disc (VCD only) and output in NTSC format.

Multi – Select this if the connected TV is compatible with both NTSC and PAL (multi-system). The output format will be in accordance with the video signal of the disc.

- ⑤ Select an item and press **OK**.

Helpful Hints:

- **Before changing the current TV Standard setting, ensure that your TV supports the 'selected TV Type' system.**
- **If there is no proper picture on your TV, wait for 15 seconds for auto recovery.**

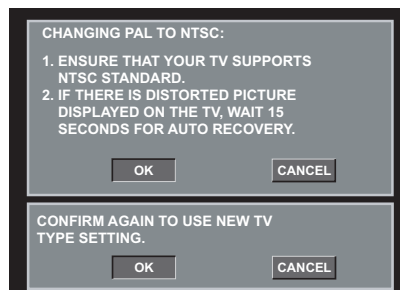

TIPS: To return to the previous menu, press **◀**.
To remove the menu, press **SYSTEM MENU**.

Getting Started

Step 3: Setting language preference

You can select your preferred language settings. This DVD Player will automatically switch to the language for you whenever you load a disc.

Setting the OSD Language

The On-screen language for the system menu will remain as you set it, regardless of various disc languages.

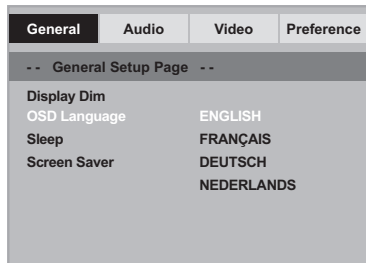

- 1 Press **SYSTEM MENU**.
- 2 Press **▲▼** to highlight {OSD LANGUAGE}, then press **▶**.
- 3 Press **▲▼** to select a language and press **OK**.

Setting the Audio, Subtitle and Disc menu language

You can choose your own preferred language or soundtrack from audio, subtitles and disc menu languages. If the language selected is not available on the disc, the disc's default language will be used instead.

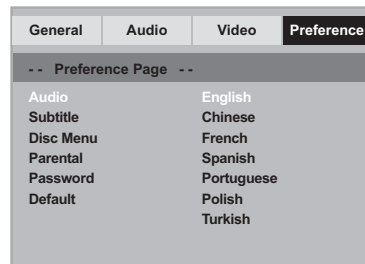

- 1 Press **STOP** twice then, press **SYSTEM MENU**.
- 2 Press **▶** repeatedly to select {PREFERENCE PAGE}.
- 3 Press **▲▼** to highlight one of the options below at a time, then press **▶**.
 - 'Audio' (disc's soundtrack)
 - 'Subtitle' (disc's subtitles)
 - 'Disc Menu' (disc's menu)
- 4 Press **▲▼** to select a language and press **OK**.

If the language you want is not in the list, then select {OTHERS}, then use the **numeric keypad (0-9)** on the remote to enter the 4-digit language code 'XXXX' (see page 5 "Language Code") and press **OK**.

- 5 Repeat steps 3~4 for other language settings.

TIPS: To return to the previous menu, press **◀**.
To remove the menu, press **SYSTEM MENU**.

Disc Operations

IMPORTANT!

- If the inhibit icon (Ø) appears on the TV screen when a button is pressed, it means the function is not available on the current disc or at the current time.
- Depending on the DVD or VIDEO CD, some operations may be different or restricted.
- Do not push on the disc tray or put any objects other than disc on the disc tray. Doing so may cause the disc player malfunction.

Playable Discs

Your DVD Player will play:

- Digital Versatile Discs (DVDs)
- Video CDs (VCDs)
- Super Video CDs (SVCDs)
- Digital Video Discs + Recordable[Rewritable] (DVD+R[W])
- Compact Discs (CDs)
- MP3 discs, picture (Kodak, JPEG) files on CD-R(W).
 - JPEG/ISO 9660 format
 - Maximum 30 characters display.
 - Supported sampling frequencies : 32 kHz, 44.1 kHz, 48 kHz (MPEG-1)
 - Supported Bit-rates : 32~256 kbps (MPEG-1), variable bitrates



Region Codes

DVD discs must be labeled for ALL regions or Region 2 in order to play on this Player. You cannot play Discs that are labeled for other regions.



Helpful Hints:

- It may not be possible to play CD-R/RW or DVD-R/RW in all cases due to the type of disc or condition of the recording.
- If you are having trouble playing a certain disc, remove the disc and try a different one. Improper formatted disc will not play on this DVD Player.

Playing discs

- 1 Connect the power cords of the DVD Player and TV (and any optional stereo or AV receiver) to a power outlet.
- 2 Turn on the TV power and set to the correct Video In channel. (See page 15 "Setting up the TV").
- 3 Press **STANDBY-ON** on the DVD Player front panel.
→ You should see the Philips DVD background screen on the TV.
- 4 Press **OPEN/CLOSE** ▲ button to open the disc tray and load in a disc, then press the same button again to close the disc tray.
→ Make sure the label side is facing up. For double-sided discs, load the side you want to play facing up.
- 5 Playback will start automatically. If not press **PLAY** ►.
→ If a disc menu appears on the TV, see page 21 "Using the Disc Menu".

TIPS: The operating features described here might not be possible for certain discs. Always refer to the instructions supplied with the discs.

Disc Operations

Basic playback controls

Unless otherwise stated, all operations described are based on Remote Control use.

Pausing playback

- 1 During playback, press **PAUSE II**.
→ Playback will pause and sound will be muted.
- 2 To resume normal playback, press **PLAY ►**.

Selecting track/chapter

- 1 Press **►►►** / **◄◄◄** briefly during playback to go to the next chapter/track or to return to the beginning of the current chapter/track respectively.
- 2 To go directly to any chapter/track, enter the chapter/track number using the numerical keys (0-9).
(e.g. single number of chapter/track with digit '0' in front, for example '06')
- For DVD
→ Press **◄◄** twice briefly to step back to the previous chapter/track.
- For VCD
→ It cannot work when PBC is set to 'ON'.

Searching backward/forward

- 1 Press **◄►** during playback to select the required speed: 2X, 4X, 8X, 16X or 32X (backward or forward).
→ Sound will be muted (DVD/VCD) or intermittent (CD).
- 2 To return to normal speed, press **PLAY ►** or **OK**.

Stopping playback

- Press **■**.

Selecting various repeat/shuffle functions

Repeat play mode

- Press **REPEAT** continuously to choose a Repeat mode during playback.

CHAPTER (DVD)

- to repeat playback of the current chapter.

TRACK/TITLE (SVCD/VCD/DVD)

- to repeat playback of the current track (SVCD/VCD)/title (DVD).

ALL

- to repeat playback of the disc.

OFF

- to cancel the repeat mode.

- Press **REPEAT** repeatedly to cancel the repeat mode.

Helpful Hint:

- *REPEAT function is not available for VCD 2.0 when PCB is on.*

Repeating a section within a chapter/track

- 1 While playing a disc, press **REPEAT A-B** at your chosen starting point.
- 2 Press **REPEAT A-B** again at your chosen end point.
→ The section will now repeat continuously.
- 3 To exit the sequence, press **REPEAT A-B**.

TIPS: The operating features described here might not be possible for certain discs. Always refer to the instructions supplied with the discs.

Disc Operations

Operations for video playback (DVD/VCD/SVCD)

Using the Disc Menu

Depending on the disc, a menu may appear on the TV screen once you load in the disc.

To select a playback feature or item

- Use ◀▶▲▼ keys or **numeric keypad (0-9)** on the remote, then press **OK** to start playback.

To access or remove the menu

- Press **DISC MENU** on the remote.

Zooming in

This function allows you to enlarge the picture on the TV screen and to pan through the enlarged picture.

- 1 During playback, press **ZOOM** repeatedly to display the picture with different scales.
 - Use ◀▶▲▼ keys to pan through the enlarged picture.
 - Playback will continue.
- 2 Press **ZOOM** repeatedly to return to the original size.

Resuming playback from the last stopped point

During playback, press **STOP** once (the disc has not been ejected) to activate the resume mode.

- Press **PLAY ▶**.
 - Playback will start from the last stop point.
- Press **STOP** twice to cancel the resume mode.

Helpful Hint:

- Resume option may not be available on some discs.

TIPS: The operating features described here might not be possible for certain discs. Always refer to the instructions supplied with the discs.

Slow Motion

- 1 Press ▲ during playback to select the required speed: 1/2, 1/4, 1/8 or 1/16 (forward).
 - Sound will be muted.
- 2 To return to normal speed, press **PLAY ▶**.

Helpful Hint:

- Slow backward is not possible on VCDs.

OSD (On-Screen Display)

This function displays disc information on the TV screen during playback.

- 1 During playback, press **DISPLAY** repeatedly.
 - A list of available disc information appears on the TV screen.
- 2 Use ◀▶ keys to select an option.
- 3 Enter hours, minutes and seconds from left to right in the time edit box using remote control numerical key pad.
 - Playback will change to the chosen time or to the selected title/chapter/track.

For DVD

→ {Title CT:TT Chapter XX/TC}: displays the total available title and chapters in the disc and enable to select a chapter for viewing.

→ {Title CT:TT Time X:XX:XX}: displays the total available title in the disc and enable to select the hour, minute and second of the title.

→ {Chapter CC:TC Time X:XX:XX}: displays the total available chapter in the disc and enable to select the hour, minute and second of the title.

For Super VCD or VCD

→ {Disc Go To XX:XX}: enable to select any part within the disc.

→ {Track Go To XX:XX}: enable to select any part within the current track.

→ {Select Track XX:TT}: enable to select any track.

Disc Operations

Special DVD Features

Playing a Title

- 1 Press **DISC MENU**.
→ The disc menu appears on the TV screen.
- 2 Use **▲▼◀▶** keys or **numeric keypad (0-9)** to select a play option.
- 3 Press **OK** key to confirm.

Camera Angle

- Press **ANGLE** repeatedly to select different desired angle.

Changing the Audio Language

For DVD

- Press **AUDIO** repeatedly to select different audio languages.

Changing the Audio Channel

For VCD

- Press **AUDIO** to select the available audio channels provided by the disc (MONO LEFT, MONO RIGHT, MIX-MONO, STEREO).

Subtitles

- Press **SUBTITLE** repeatedly to select different subtitle languages.

Special VCD & SVCD Features

Playback Control (PBC)

For VCD with Playback Control (PBC) feature (version 2.0 only)

- Press **DISC MENU** to toggle between 'PBC ON' and 'PBC OFF'.
→ If you select 'PBC ON', the disc menu (if available) will appear on the TV.
→ Use the **◀◀ / ▶▶** or the numeric keypad (0-9) to select a play option.
- During playback, pressing **RETURN/TITLE** will return to the menu screen (if PBC is on).

If you want to skip the index menu and playback directly from the beginning,

- Press **DISC MENU** key on the remote control to switch to PBC off.

TIPS: The operating features described here might not be possible for certain discs. Always refer to the instructions supplied with the discs.

Disc Operations

Playing MP3/JPEG (Kodak) Picture CD

IMPORTANT!

You have to turn on your TV and set to the correct Video In channel. (See page 15 "Setting up the TV").

- Load a Picture disc (Kodak Picture CD, JPEG).
 - For Kodak disc, the slide show will begin.
 - For JPEG disc, the picture menu appears on the TV screen. Press **PLAY** ► to start the slide-show playback.

General Operation

- 1 Load an MP3/JPEG Picture CD disc.
 - The data disc menu appears on the TV screen.
- 2 Press ▲ ▼ to select the folder and press **OK** to open the folder.

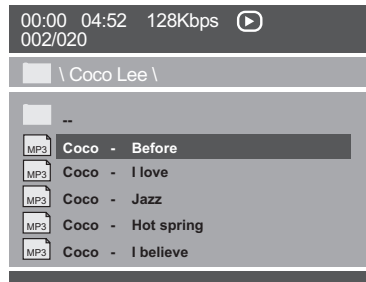

- 3 Press ▲ ▼ or use the numeric keypad (0-9) to highlight an option.
- 4 Press **OK** to confirm.
 - Playback will start from the selected file to the end of the folder.

Playback selection

During playback, you can;

- Press |◀◀ / ▶▶| to select another track/file in the current folder.
- Press **II** / ► repeatedly to pause/resume playback.

Repeat

- Press **REPEAT** continuously to access different 'Play Mode'.

In STOP mode (folder view),

- SINGLE
- REPEAT ONE
- REPEAT FOLDER
- FOLDER
- SHUFFLE

In PLAY mode,

- SINGLE
- REPEAT ONE
- REPEAT ALL
- REPEAT OFF
- SHUFFLE

Fast forward / reverse (MP3)

- During playback, press ◀▶ to fast forward or reverse playback.
- To resume normal playback, press **PLAY** ►.

TIPS: The operating features described here might not be possible for certain discs. Always refer to the instructions supplied with the discs.

DVD Setup Menu Options

This DVD Player setup is carried out via the TV, enabling you to customise the DVD Player to suit your particular requirements.

General Setup menu

- 1 In disc mode, press **SYSTEM MENU**.
- 2 Press **◀▶** to select 'General Setup' icon.
- 3 Press **OK** to confirm.

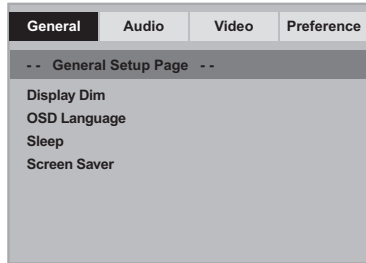

Dimming player's display panel

You can select different levels of brightness for the display screen.

- 1 In 'GENERAL SETUP PAGE', press **▲▼** to highlight {DISPLAY DIM}, then press **▶**.
 - 100%**
Select this for full brightness.
 - 70%**
Select this for medium brightness.
 - 40%**
Select this for dimming the display.
- 2 Press **▲▼** to select a setting, then press **OK** to confirm your selection.

OSD Language

This menu contains various language options for display language on the screen. For details, see page 18.

Sleep

Sleep function allows you to turn off the DVD Player automatically after a preset time.

- 1 In 'GENERAL SETUP PAGE', press **▲▼** to highlight {SLEEP}, then press **▶**.

15 Mins

Turn off the DVD Player after 15 minutes.

30 Mins

Turn off the DVD Player after 30 minutes.

45 Mins

Turn off the DVD Player after 45 minutes.

60 Mins

Turn off the DVD Player after 60 minutes.

OFF

Turn off the sleep function.

- 2 Press **▲▼** to select a setting, then press **OK** to confirm your selection.

Screen Saver - turning on/off

The screen saver will help to prevent your TV display device from becoming damaged.

- 1 In 'GENERAL SETUP PAGE', press **▲▼** to highlight {SCREEN SAVER}, then press **▶**.
 - ON**
Select this if you wish to turn off the TV screen when disc playback is stopped or paused for more than 15 minutes.
 - OFF**
Select this to disable the screen saver function.
- 2 Press **▲▼** to select a setting, then press **OK** to confirm your selection.

TIPS: To return to the previous menu, press **◀**.
To remove the menu, press **SYSTEM MENU**.

DVD Setup Menu Options

Audio Setup Menu

- 1 In disc mode, press **SYSTEM MENU**.
- 2 Press ◀▶ to select 'Audio Setup' icon.
- 3 Press **OK** to confirm.

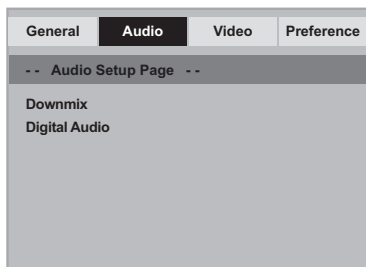

Setting the Downmix

This options allows you to set the stereo analog output of your DVD Player.

- 1 In 'AUDIO SETUP PAGE', press ▲▼ to highlight {DOWNMIX}, then press ▶.

LT/RT

Select this option if your DVD Player is connected to a Dolby Pro-Logic decoder.

STEREO

Select this to change channel output to stereo which delivers sound from only the two front speakers.

- 2 Press ▲▼ to select a setting, then press **OK** to confirm your selection.

Digital Audio Setup

The options included in Digital Audio Setup are: 'Digital Audio' and 'LPCM'.

- 1 In 'AUDIO SETUP PAGE', press ▲▼ to highlight {DIGITAL AUDIO}, then press ▶.
- 2 Press the ▲▼ keys to highlight an option.
- 3 Enter its submenu by pressing ▶.
- 4 Move the cursor by pressing the ▲▼ keys to highlight the selected item.

Digital Output

Set the Digital output according to your optional audio equipment connection.

→ **All**: If you have connected your DIGITAL AUDIO OUT to a multi-channel decoder/receiver.

→ **PCM Only**: Only if your receiver is not capable of decoding multi-channel audio.

Helpful Hints:

– If DIGITAL AUDIO is set to 'All', all audio settings except MUTE are invalid.

LPCM Output

If you connect the DVD Player to a PCM compatible receiver via the digital terminals, such as coaxial or optical etc, you may need to adjust 'LPCM'.

Discs are recorded at a certain sampling rate. The higher the sampling rate, the better the sound quality.

→ **48k**: Playback a disc recorded at the sampling rate of 48kHz.

→ **96k**: Playback a disc recorded at the sampling rate of 96kHz.

TIPS: To return to the previous menu, press ◀.
To remove the menu, press **SYSTEM MENU**.

DVD Setup Menu Options

Video Setup Menu

- 1 In disc mode, press **SYSTEM MENU**.
- 2 Press ◀▶ to select 'Video Setup' icon.
- 3 Press **OK** to confirm.

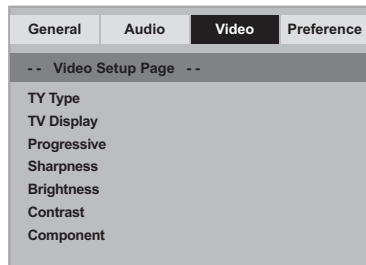

TV Type

This menu contains the options for selecting the colour system that matches the connected TV. For details, see page 17.

Setting the TV Display

Set the aspect ratio of the DVD Player according to the TV you have connected. The format you select must be available on the disc. If it is not, the setting for TV display will not affect the picture during playback.

- 1 In 'VIDEO SETUP PAGE', press ▲▼ to highlight {TV DISPLAY}, then press ▶.
- 2 Press ▲▼ to highlight one of the options below:

4:3 PAN SCAN –

Select this if you have a normal TV and want both sides of the picture to be trimmed or formatted to fit your TV screen.

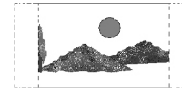

4:3 LETTER BOX –

Select this if you have a normal TV. In this case, a wide picture with black bands on the upper and lower portions of the TV screen will be displayed.



16:9 – Select this if you have a wide-screen TV.



- 3 Select an item and press **OK**.

TIPS: To return to the previous menu, press ◀.
To remove the menu, press **SYSTEM MENU**.

DVD Setup Menu Options

Progressive - turning on/off

In the progressive scan mode, you can enjoy the high quality picture with less flickers. It only works when you have connected the DVD player's Y Pb Pr jacks to your TV that supports the progressive video input. Otherwise, the a distorted picture will appear on the TV. For proper progressive scan set up, see page 16.

- 1 In 'VIDEO SETUP PAGE', press ▲ ▼ to highlight {PROGRESSIVE}, then press ►.

ON

To enable Progressive Scan function.

OFF

To disable Progressive Scan function.

- 2 Press ▲ ▼ to select a setting, then press **OK** to confirm your selection.
 - Follow the instructions shown on the TV to confirm the selection (if any).
 - If a distorted picture appears on the TV screen, wait for 15 seconds for auto recovery.

Sharpness

You can personalize your picture colour by adjusting sharpness.

- 1 In 'VIDEO SETUP PAGE', press ▲ ▼ to highlight {SHARPNESS}, then press ►.

HIGH

Choose high to make the picture's edge sharper.

MEDIUM

Choose medium to get a standard picture.

LOW

Choose low to make the picture's edge softer.

- 2 Press ▲ ▼ to select a setting, then press **OK** to confirm your selection.

Brightness / Contrast

Increasing the value will brighten the picture or vice versa. Choose zero (0) for average setting.

- 1 In 'VIDEO SETUP PAGE', press ▲ ▼ to highlight {BRIGHTNESS} or {CONTRAST}, then press ►.
 - The menu appears.

Brightness 0

Contrast 0

- 2 Press ◀ ▶ to adjust the setting that best suit your personal preference.
- 3 Press **OK** to confirm.

Switching the YUV/RGB

This setting allows you to toggle the output of the video signal between RGB (on scart) and Y Pb Pr (YUV).

- 1 In 'VIDEO SETUP PAGE', press ▲ ▼ to highlight {COMPONENT}, then press ►.

YUV

Select this for Y Pb Pr connection.

RGB

Select this for Scart connection.

- 2 Press ▲ ▼ to select a setting, then press **OK** to confirm your selection.

Warning:

- **When the player is set to Y Pb Pr (YUV), some TV may not properly synchronise with player on the SCART connector.**
- **When RGB is selected, progressive scan output will be deactivated.**

TIPS: To return to the previous menu, press ◀.
To remove the menu, press **SYSTEM MENU**.

DVD Setup Menu Options

Preference Page

- 1 Press **■** twice to stop playback (if any), then press **SYSTEM MENU**.
- 2 Press **◀▶** to select the 'Preference Page' icon.
- 3 Press **OK** to confirm.

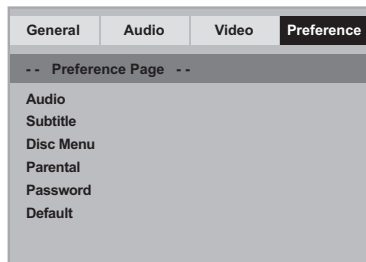

Audio, Subtitle, Disc Menu

These menus contain various language options for audio, subtitle and disc menu which may be recorded on the DVD. For details, see page 18.

Restricting playback by Parental Control

Some DVDs may have a parental level assigned to the complete disc or to certain scenes on the disc. This feature lets you set a playback limitation level. The rating levels are from 1 to 8 and are country dependent. You can prohibit the playing of certain discs that are not suitable for your children or have certain discs played with alternative scenes.

- 1 In 'PREFERENCE PAGE', press **▲▼** to highlight {PARENTAL}, then press **▶**.

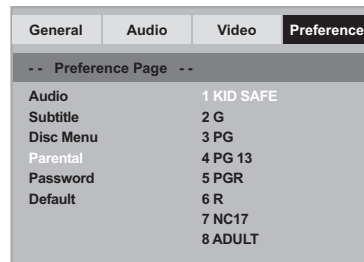

- 2 Press **▲▼** to highlight a rating level for the disc inserted and press **OK**.
→ To disable Parental controls and have all Discs play, select {8 ADULT}.
- 3 Use the **numeric keypad (0-9)** to enter the six-digit password (see page 29 "Changing the password").
→ DVDs that are rated above the level you selected will not play unless you enter your six-digit password.

Helpful Hints:

- VCD, SVCD, CD have no level indication, so parental control function has no effect on these type of discs. This applies to most illegal DVD discs.
- Some DVDs are not encoded with a rating though the movie rating may be printed on the Disc cover. The rating level feature does not work for such Discs.

TIPS: To return to the previous menu, press **◀**.
To remove the menu, press **SYSTEM MENU**.

DVD Setup Menu Options

Changing the Password

This feature is used for Parental Control. Enter your six-digit password when prompted on the screen. The default password is 136900.

- 1 In 'PREFERENCE PAGE', press ▲ ▼ to highlight {PASSWORD}, then press ► to select {CHANGE}.

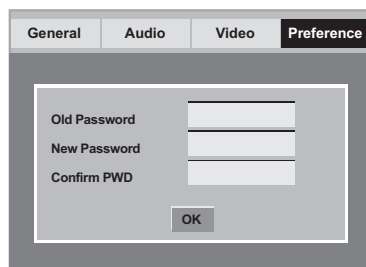

- 2 Use the **numeric keypad (0-9)** to enter your old six-digit password.
 - When doing this for the first time, key in '136900'.
 - If you forget your old six-digit password, key in '136 900'.
- 3 Enter the new six-digit password.
- 4 Enter the new six-digit password a second time to confirm.
 - The new six-digit password will now take effect.
- 5 Press **OK** to confirm.

Restoring to original settings

Setting the DEFAULT function will reset all options and your personal settings to the factory defaults, except your password for Parental Control.

- 1 In 'PREFERENCE PAGE', press ▲ ▼ to highlight {DEFAULT}, then press ► to select {RESET}.
- 2 Press **OK** to confirm.
 - All settings will now reset to factory defaults.

TIPS: To return to the previous menu, press ◀.
To remove the menu, press **SYSTEM MENU**.

Troubleshooting

WARNING

Under no circumstances should you try to repair the system yourself, as this will invalidate the warranty. Do not open the system as there is a risk of electric shock.

If a fault occurs, first check the points listed below before taking the system for repair. If you are unable to remedy a problem by following these hints, consult your dealer or Philips for help.

Problem	Solution
No power	<ul style="list-style-type: none"> – Check if the AC power cord is properly connected. – Press the STANDBY ON on the front of the DVD system to turn on the power.
No picture	<ul style="list-style-type: none"> – Refer to your TV's manual for correct Video In channel selection. Change the TV channel until you see the DVD screen. – Check if the TV is switched on. – If the progressive scan feature is activated but the connected TV does not support progressive signals or the cables are not connected accordingly, see page 16 for proper progressive scan set up or deactivate the progressive scan feature as below: <ol style="list-style-type: none"> 1) Turn off your TV progressive scan mode or turn on to interlaced mode. 2) Press OPEN/CLOSE to open the disc tray. 3) Press numeric keypad '1' on the remote control for few seconds.
Distorted picture	<ul style="list-style-type: none"> – Sometimes a small amount of picture distortion may appear depending on the disc being played back. This is not a malfunction.
Completely distorted picture or black/white picture with DVD	<ul style="list-style-type: none"> – Connect DVD Player directly to the TV. – Make sure the disc is compatible with the DVD/Player. – Ensure that the DVD Player's TV Type is set to match that of the Disc and your TV.
No sound or distorted sound	<ul style="list-style-type: none"> – Adjust the volume. – Check that the speakers are connected correctly.
No audio at digital output	<ul style="list-style-type: none"> – Check the digital connections. – Check if your receiver can decode MPEG-2 and if not, please make sure the digital output is set to ALL. – Check if the audio format of the selected audio language matches your receiver capabilities.

Visit us at www.philips.com/support for service support

Troubleshooting

Problem	Solution
Disc can't be played	<ul style="list-style-type: none">– The DVD+R/CD-R must be finalised.– Ensure the disc label is facing up.– Check if the disc is defective by trying another disc.– Region code incorrect.
Picture freezes momentarily during playback	<ul style="list-style-type: none">– Check the disc for fingerprints/scratches and clean with a soft cloth wiping from centre to edge.
No return to start-up screen when disc is removed	<ul style="list-style-type: none">– Reset the unit by switching the player off, then on again.
The player does not respond to the Remote Control	<ul style="list-style-type: none">– Aim the Remote Control directly at the sensor on the front of the player.– Reduce the distance to the player.– Replace the batteries in the Remote Control.– Re-insert the batteries with their polarities (+/- signs) as indicated.
Buttons do not work	<ul style="list-style-type: none">– To completely reset the player, unplug the AC cord from the AC outlet for 15-20 seconds.
Player does not respond to some operating commands during playback.	<ul style="list-style-type: none">– Operations may not be permitted by the disc. Refer to the instructions of the disc jacket.
DVD Player cannot read CDs/DVDs	<ul style="list-style-type: none">– Use a commonly available cleaning CD/DVD to clean the lens before sending the DVD Player for repair.
Menu items cannot be selected	<ul style="list-style-type: none">– Press STOP twice before selecting System Menu.– Depending on the disc availability, some menu items cannot be selected.

English

Specifications

TV STANDARD (PAL/50Hz) (NTSC/60Hz)

Number of lines	625	525
Playback	Multistandard	(PAL/NTSC)

VIDEO PERFORMANCE

DA Converter	12 bit, 108 mHz
YPbPr	0.7 Vpp — 75 ohm
Video Output	1Vpp — 75 ohm
RGB (SCART)	0.7 Vpp — 75 ohm

VIDEO FORMAT

Digital Compression	MPEG 2 for DVD,SVCD
	MPEG 1 for VCD

DVD	50Hz	60Hz
Horiz. resolution	720 pixels	720 pixels
Vertical resolution	576 lines	480 lines

VCD	50Hz	60Hz
Horiz. resolution	352 pixels	352 pixels
Vertical resolution	288 lines	240 lines

AUDIO FORMAT

Digital	MPEG/ AC-3/ PCM	compressed Digital 16, 20, 24 bits fs, 44.1, 48, 96 kHz
	MP3(ISO 9660)	96, 112, 128, 256 kbps & variable bit rate fs, 32, 44.1, 48 kHz

Analog Sound Stereo
Dolby Surround compatible downmix from Dolby Digital
multi-channel sound

AUDIO PERFORMANCE

DA Converter	24 bit, 192 kHz
DVD	fs 96 kHz 4Hz- 44kHz fs 48 kHz 4Hz- 22kHz
SVCD	fs 48 kHz 4Hz- 22kHz fs 44.1kHz 4Hz- 20kHz
CD/VCD	fs 44.1kHz 4Hz- 20kHz
Signal-Noise (1kHz)	> 90 dB
Dynamic range(1kHz)	> 90 dB
Crosstalk (1kHz)	> 80 dB
Distortion/noise (1kHz)	> 70 dB
MPEG MP3	MPEG Audio L3

CONNECTIONS

Scart Output	Euroconnector
YPbPr Output	Cinch 3x
Video Output	Cinch (yellow)
Audio Output(L+R)	Cinch (white/red)
Digital Output	1 coaxial
	IEC60958 for CDDA / LPCM
	IEC61937 for MPEG 1/2, Dolby Digital

CABINET

Dimensions (w x h x d)	360 x 37 x 265 mm
Weight	Approximately 2.0 kg

POWER CONSUMPTION

Power Supply Rating	230V; 50Hz
Power consumption	< 10 W
Power consumption in Standby mode	< 0.8 W

Specifications subject to change without prior notice

Glossary

English

Analog: Sound that has not been turned into numbers. Analog sound varies, while digital sound has specific numerical values. These jacks send audio through two channels, the left and right.

Aspect ratio: The ratio of vertical and horizontal sizes of a displayed image. The horizontal vs. vertical ratio of conventional TVs is 4:3, and that of wide-screens is 16:9.

AUDIO OUT Jacks: Jacks on the back of the DVD System that send audio to another system (TV, Stereo, etc.).

Bit Rate: The amount of data used to hold a given length of music; measured in kilobits per seconds, or kbps. Or, the speed at which you record. Generally, the higher the bit rate, or the higher the recording speed, the better the sound quality. However, higher bit rates use more space on a Disc.

Chapter: Sections of a picture or a music piece on a DVD that are smaller than titles. A title is composed of several chapters. Each chapter is assigned a chapter number enabling you to locate the chapter you want.

Component Video Out Jacks: Jacks on the back of the DVD System that send high-quality video to a TV that has Component Video In jacks (R/G/B, Y/Pb/Pr, etc.).

Disc menu: A screen display prepared for allowing selection of images, sounds, subtitles, multi-angles, etc recorded on a DVD.

Digital: Sound that has been converted into numerical values. Digital sound is available when you use the DIGITAL AUDIO OUT COAXIAL or OPTICAL jacks. These jacks send audio through multiple channels, instead of just two channels as analog does.

Dolby Digital: A surround sound system developed by Dolby Laboratories containing up to six channels of digital audio (front left and right, surround left and right, center and subwoofer).

DTS: Digital Theatre Systems. This is a surround sound system, but it is different from Dolby Digital. The formats were developed by different companies.

JPEG: A very common digital still picture format. A still-picture data compression system proposed by the Joint Photographic Expert Group, which features small decrease in image quality in spite of its high compression ratio.

MP3: A file format with a sound data compression system. "MP3" is the abbreviation of Motion Picture Experts Group 1 (or MPEG-1) Audio Layer 3. By using MP3 format, one CD-R or CD-RW can contain about 10 times as much data volume as a regular CD can.

Multichannel: DVD is specified to have each sound track constitute one sound field. Multichannel refers to a structure of sound tracks having three or more channels.

Parental Control: A function of the DVD to limit playback of the disc by the age of the users according to the limitation level in each country. The limitation varies from disc to disc; when it is activated, playback will be prohibited if the software's level is higher than the user-set level.

PCM (Pulse Code Modulation): A system for converting analog sound signal to digital signal for later processing, with no data compression used in conversion.

Playback control (PBC): Refers to the signal recorded on video CDs or SVCDs for controlling reproduction. By using menu screens recorded on a Video CD or SVCD that supports PBC, you can enjoy interactive-type software as well as software having a search function.

Progressive Scan: It displays all the horizontal lines of a picture at one time, as a signal frame. This system can convert the interlaced video from DVD into progressive format for connection to a progressive display. It dramatically increases the vertical resolution.

Region code: A system for allowing discs to be played back only in the region designated beforehand. This unit will only play discs that have compatible region codes. You can find the region code of your unit by looking on the product label. Some discs are compatible with more than one region (or ALL regions).

Title: The longest section of a picture or music feature on DVD, music, etc., in video software, or the entire album in audio software. Each title is assigned a title number enabling you to locate the title you want.

VIDEO OUT jack: Jack on the back of the DVD System that sends video to a TV.