

# Always there to help you

Register your product and get support at  
[www.philips.com/welcome](http://www.philips.com/welcome)



HTB5520

HTB5550

HTB5580

# Quick start guide

**PHILIPS**



**EN** Before using your product, read all accompanying safety information

**TR** Ürününüzü kullanmadan önce ilgili tüm güvenlik bilgilerini okuyun



HTB5520

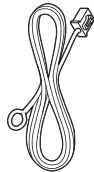
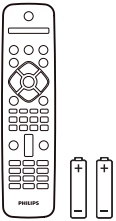
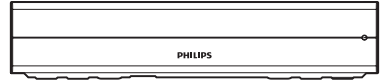
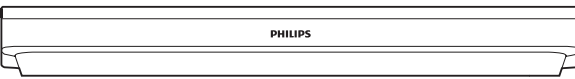

FM Antenna

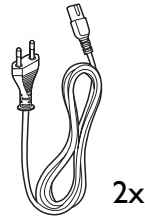

Power Cord

2x

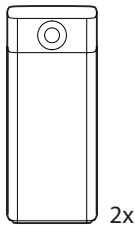
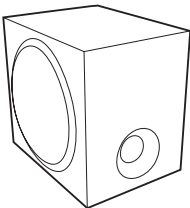
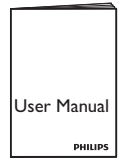

2x

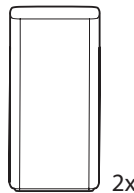

2x

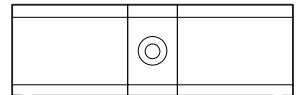

HTB5550

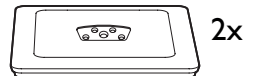
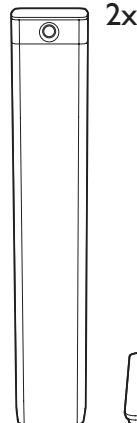
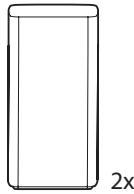
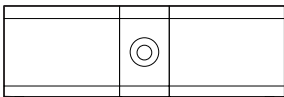
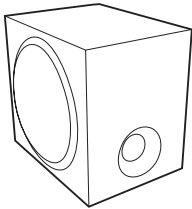
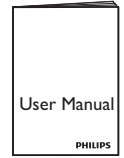
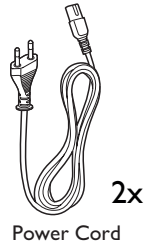
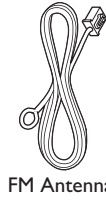
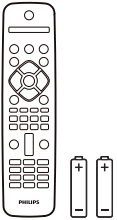
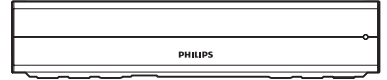
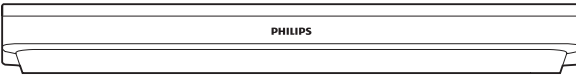

# HTB5580

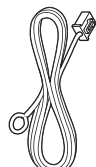
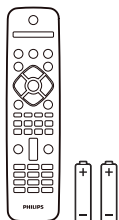
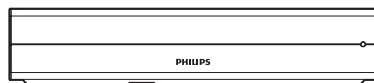
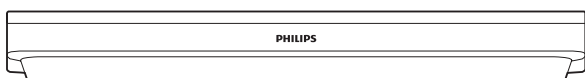

FM Antenna

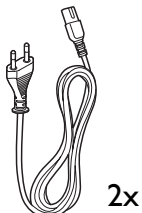

2x

Power Cord

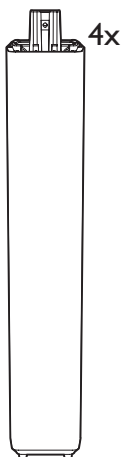
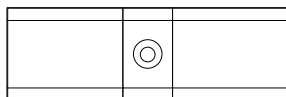
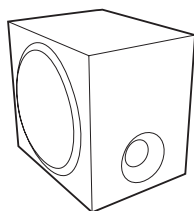
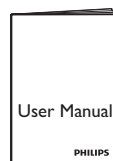

4x

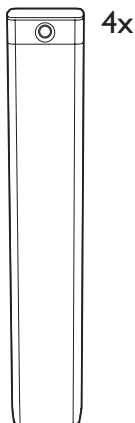

4x



16x



4x

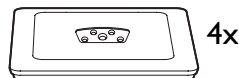

4x

# 1

HTB5550 / HTB5580 only

**EN** Stand mount the speakers

**TR** Hoparlörleri kaideye monte edin

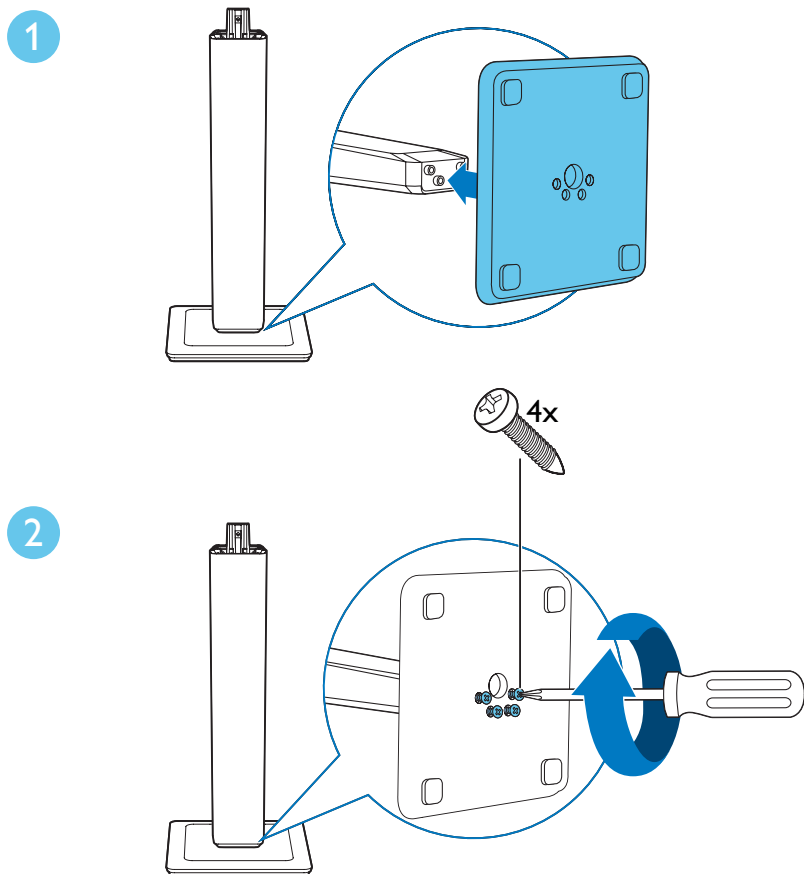

3

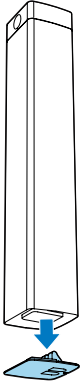

4

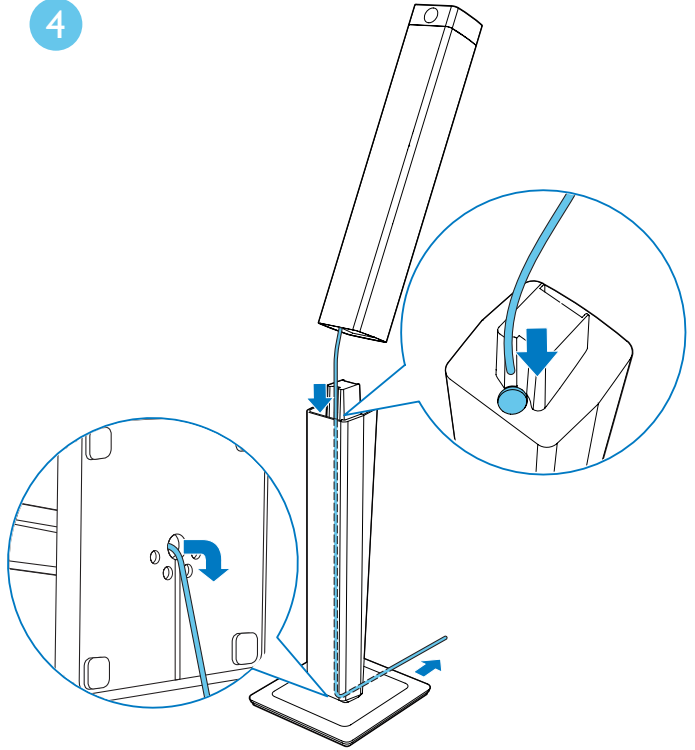

5

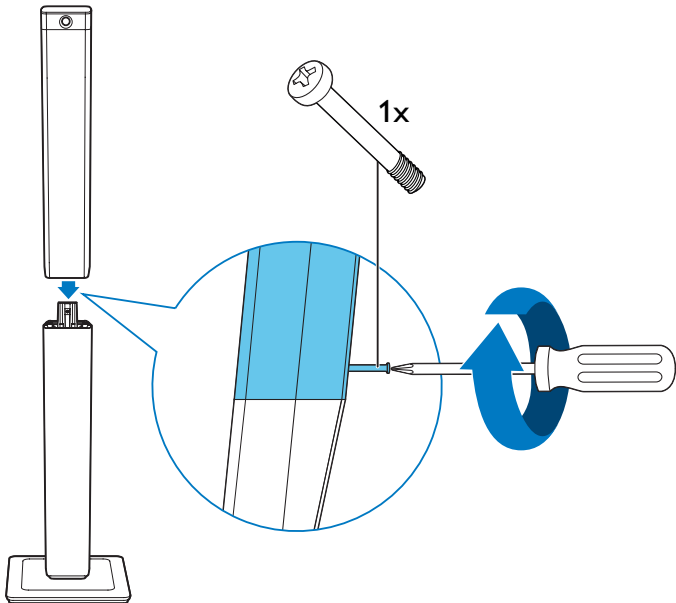

# 2

**EN** Connect the home theater

**TR** Ev sinemasını bağlayın

HTB5520

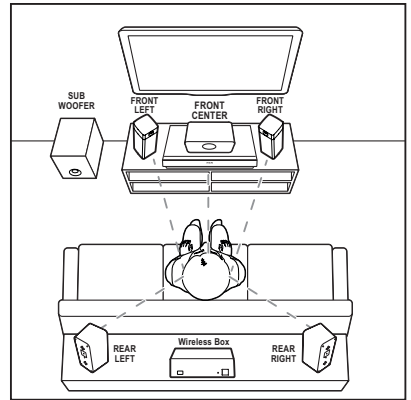
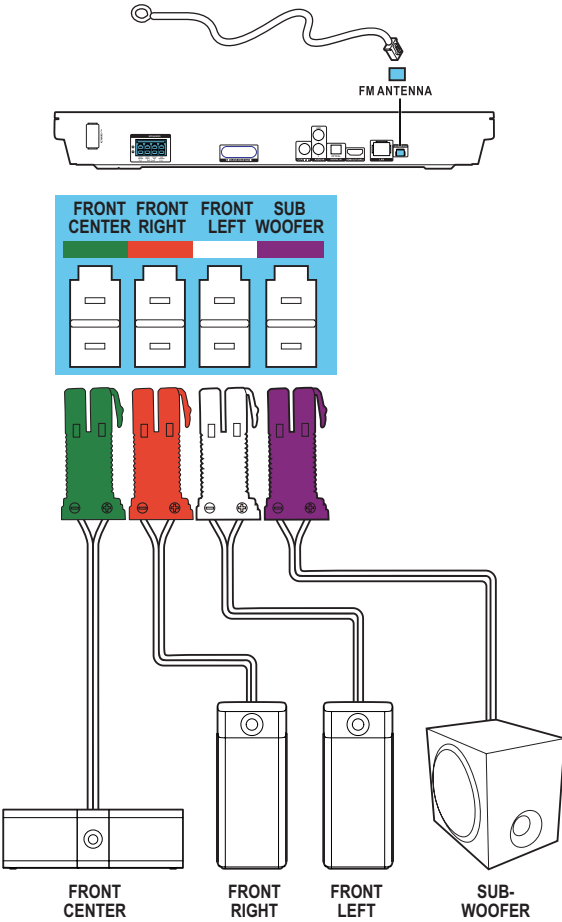

Wireless Box

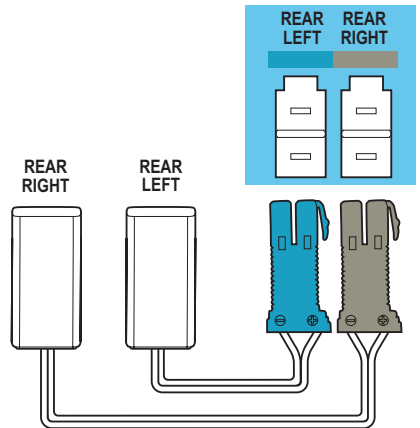

# HTB5550

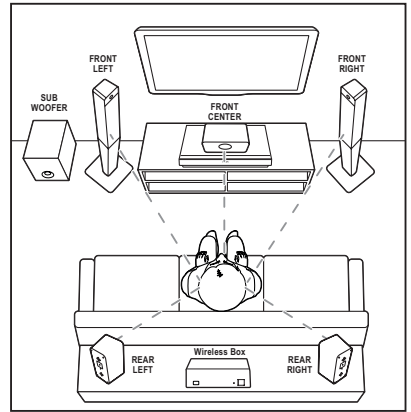
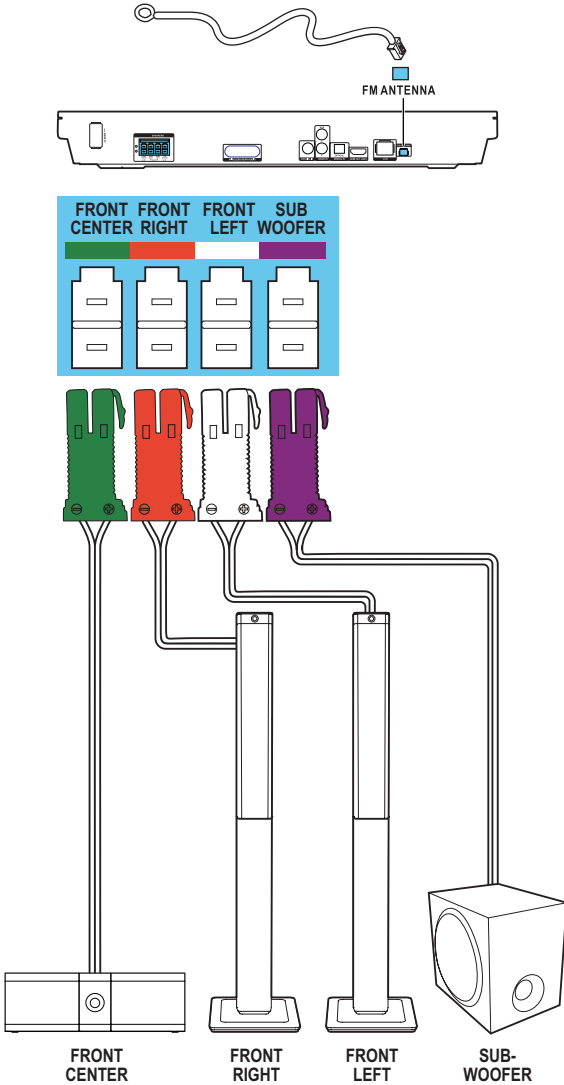

## Wireless Box

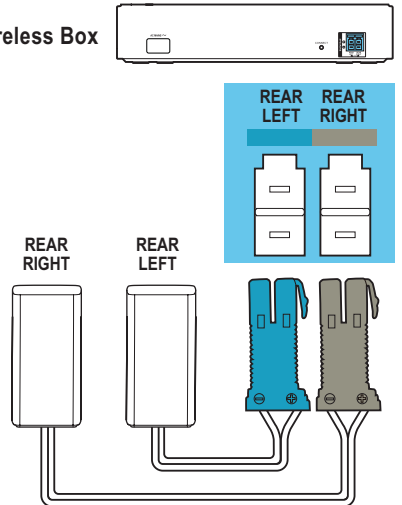



# HTB5580

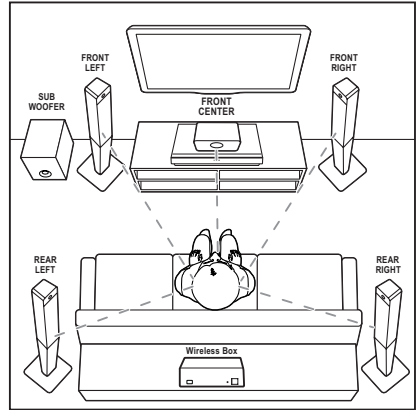
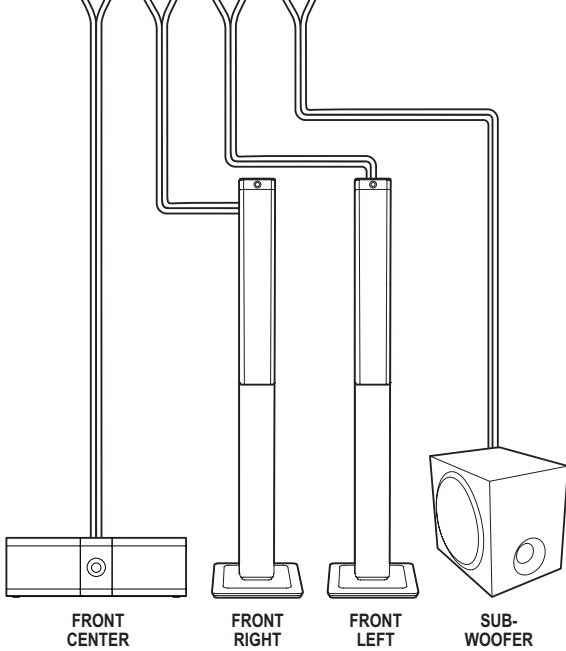
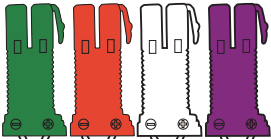
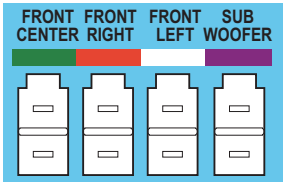
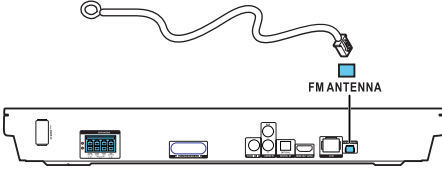

## Wireless Box

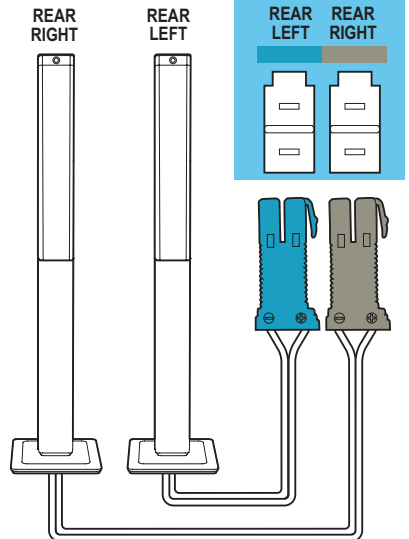

# 3

**EN** Connect to TV in one of these ways

**TR** Aşağıdaki yöntemlerden biriyle TV'ye bağlanın

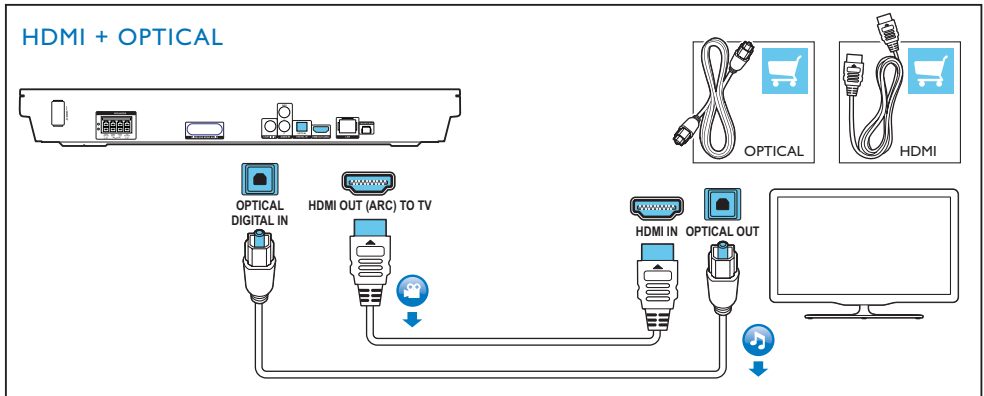
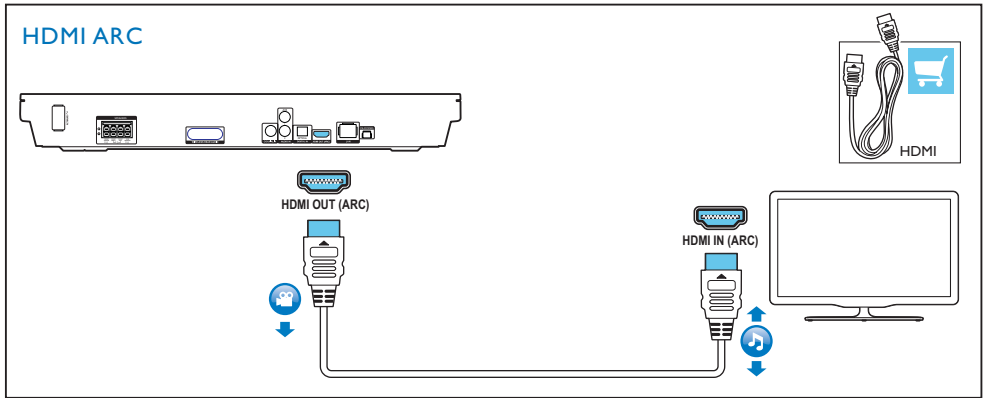

## HDMI + COAXIAL

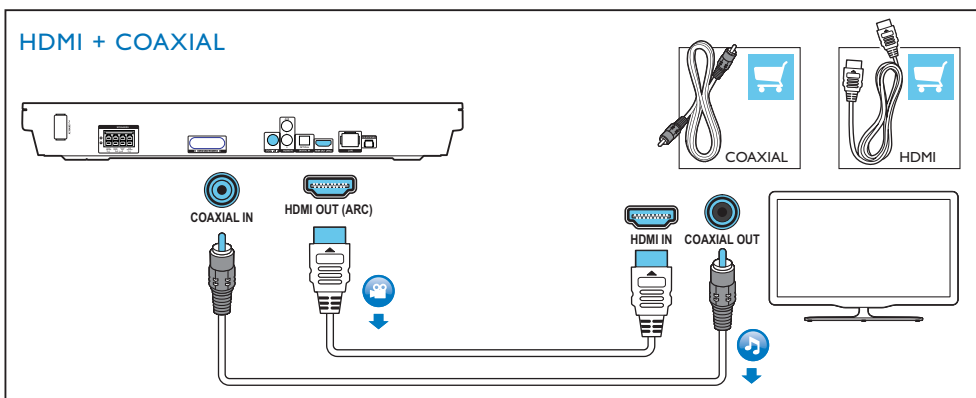

## HDMI + AUDIO L/R

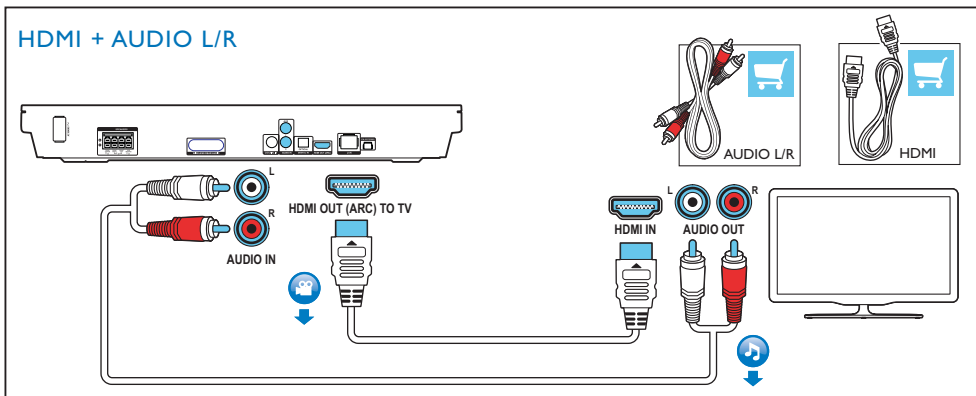

# 4a

**EN** Switch on the home theater

**TR** Ev sinemasını açın

1

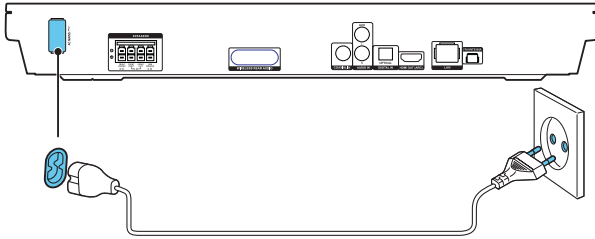

2

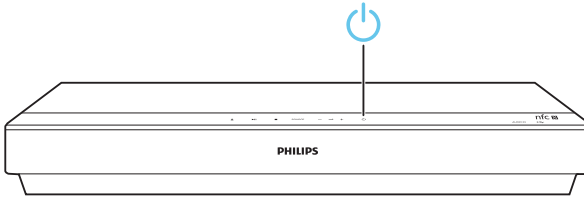

3

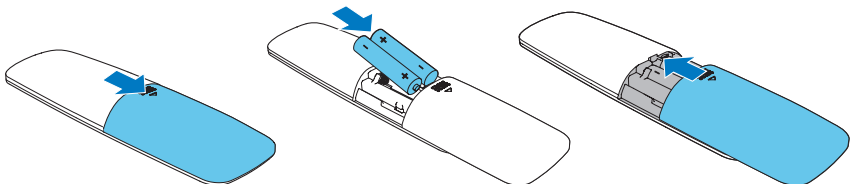

# 4b

**EN** Pair up the rear speakers (for the written instructions on pair-up of the rear speakers, refer to Chapter 3 “Connect and setup” of the User Manual)

**TR** Arka hoparlörleri eşleyin (arka hoparlörleri eşleme hakkındaki yazılı talimatlar için Kullanım Kılavuzu'nun “Bağlantı ve ayarlar” adlı 3. bölümüne başvurun).

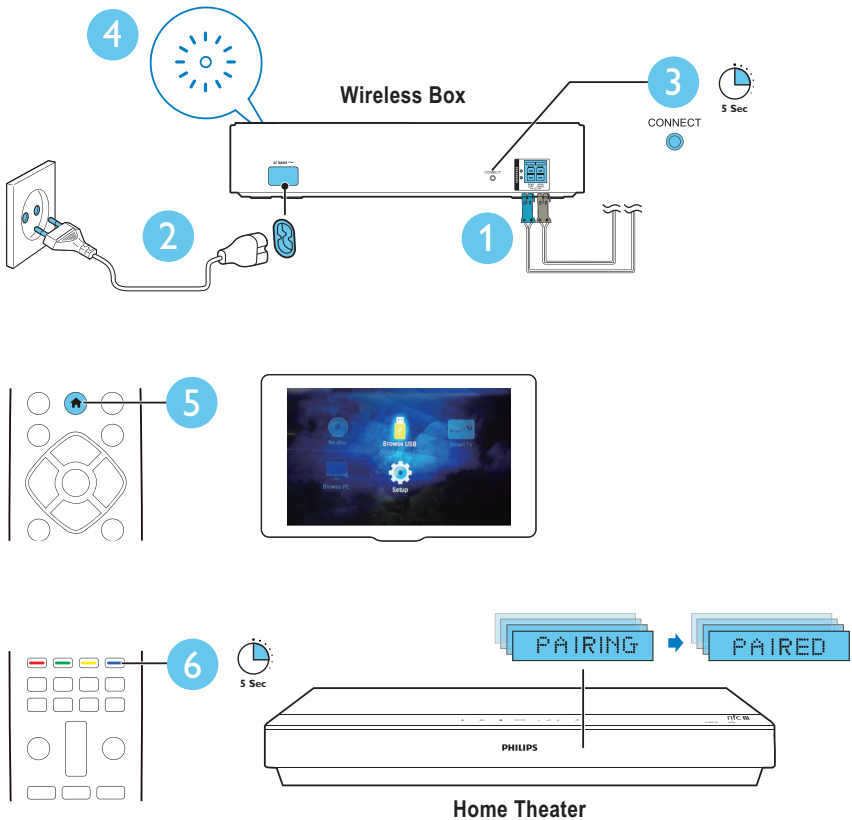

# 5

**EN** Complete the first time setup

**TR** İlk kullanım öncesi kurulumunu tamamlayın

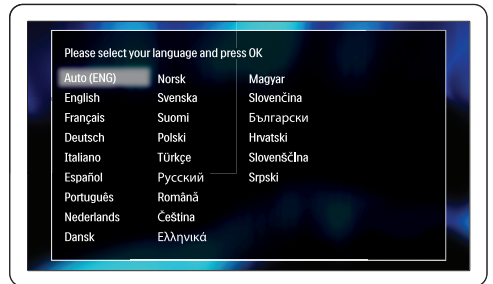
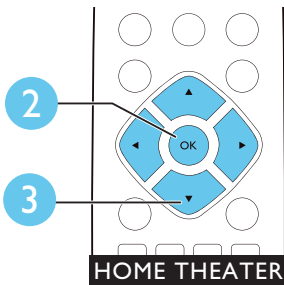
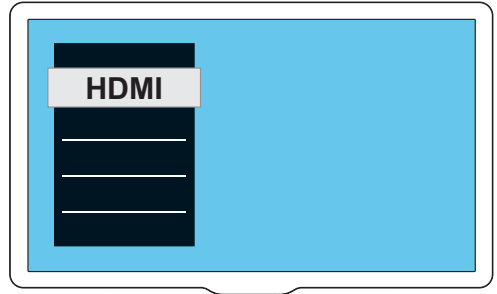
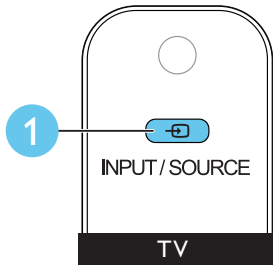

# 6

EN Use your home theater

TR Ev sinema sisteminin kullanılması

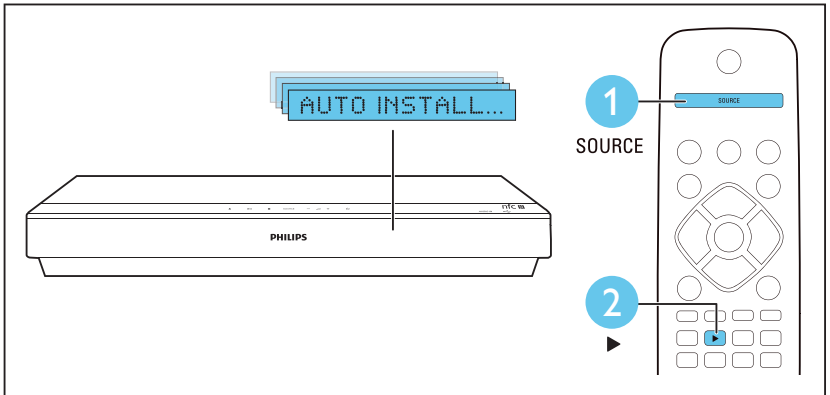
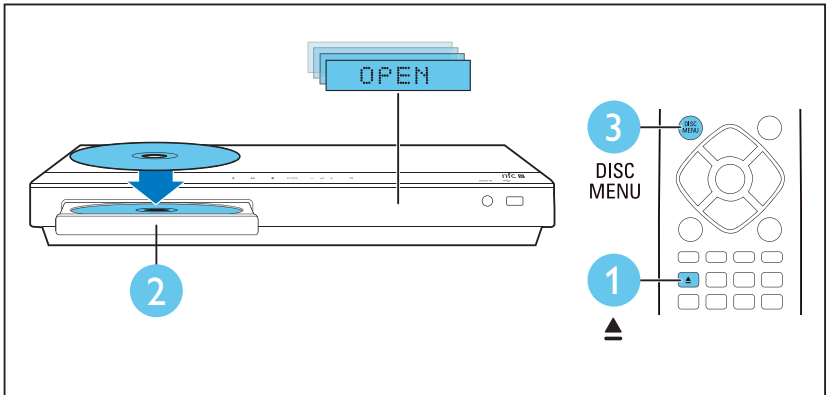

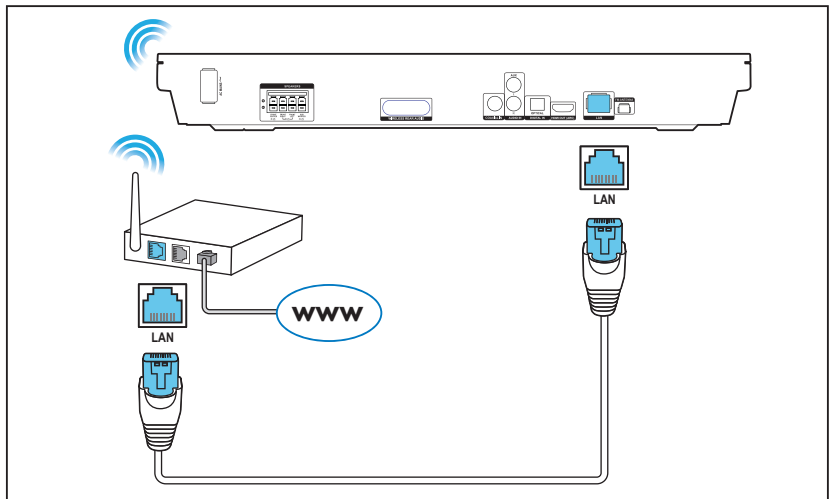
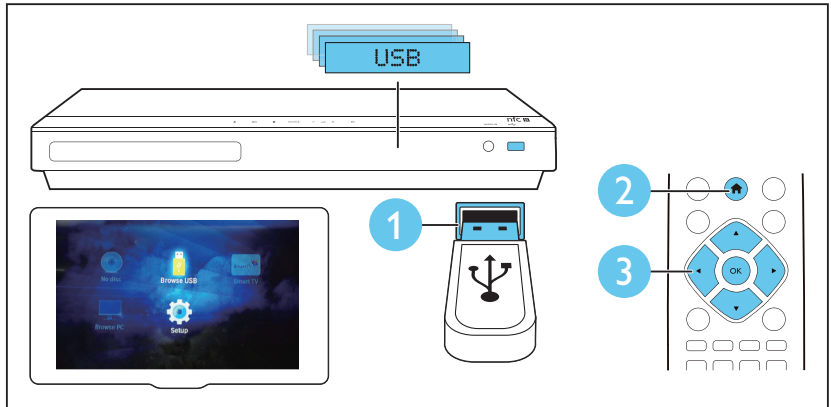
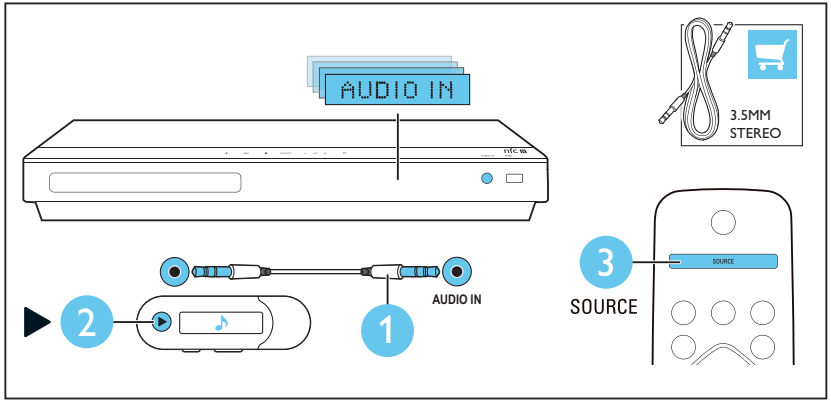



# 7

**EN** Play audio through Bluetooth or connect Bluetooth via NFC

**TR** Bluetooth üzerinden müzik çalın veya NFC üzerinden Bluetooth'u bağlayın

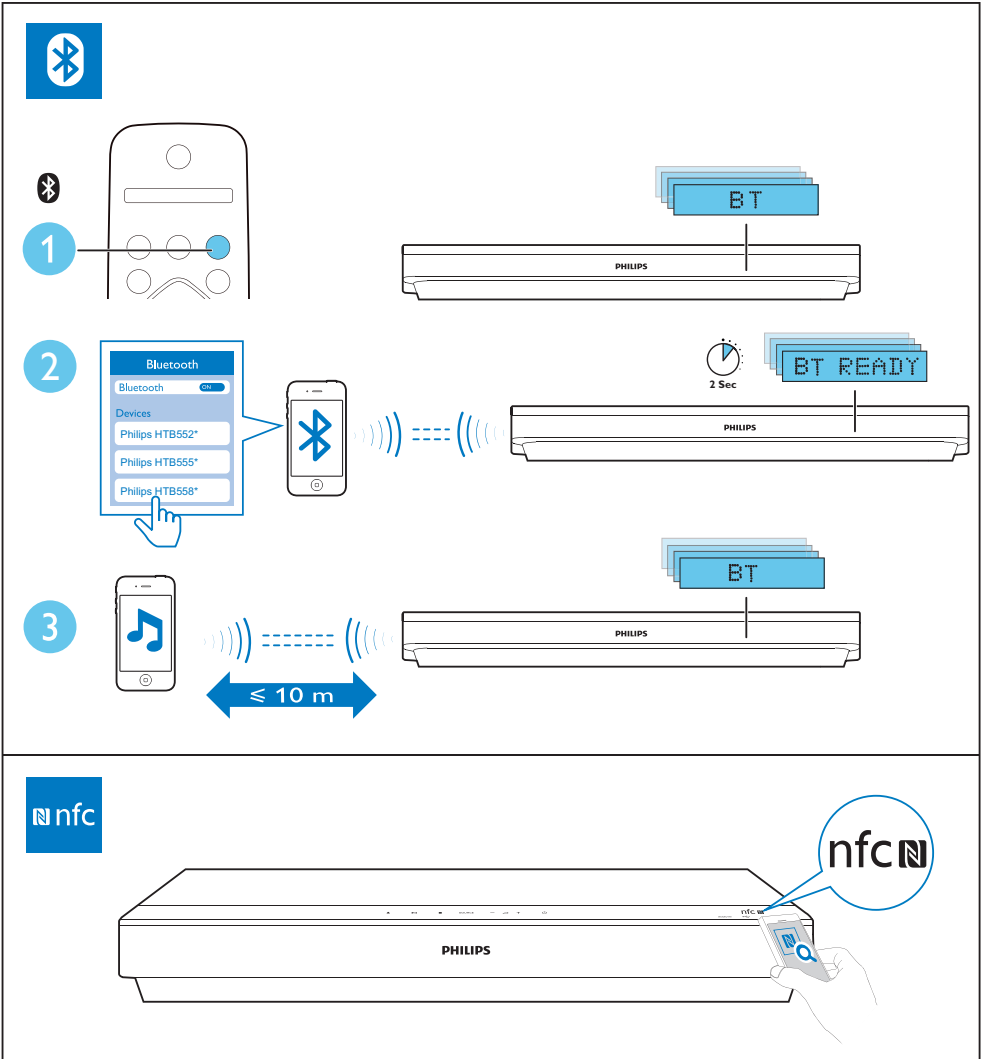



**EN** For more information about using this product, visit [www.philips.com/support](http://www.philips.com/support)

**TR** Bu ürünün kullanımı hakkında daha fazla bilgi için [www.philips.com/support](http://www.philips.com/support) adresini ziyaret edin



[www.philips.com/support](http://www.philips.com/support)





Specifications are subject to change without notice  
© 2014 Koninklijke Philips N.V. All rights reserved.  
Trademarks are the property of Koninklijke Philips N.V. or their respective owners.

HTB5520/5550/5580\_40\_QSG\_V1.0

