

Always there to help you

Register your product and get support at
www.philips.com/welcome



SBT75/85



User manual

PHILIPS

Contents

1 Important	3
Safety	3
Notice	4

2 Your Bluetooth Speaker	6
Introduction	6
What's in the box	6
Overview of the main unit	6

3 Get started	7
Connect power	7
Turn on	7

4 Play	8
Play from a Bluetooth device	8
Play from an external device	9
Control play	9

5 Product information	9
Specifications	9

6 Troubleshooting	10
--------------------------	----

1 Important

Safety

Know these safety symbols

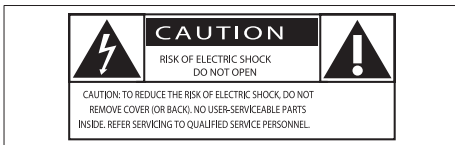

This 'bolt of lightning' indicates uninsulated material within your unit may cause an electrical shock. For the safety of everyone in your household, please do not remove product covering.

The 'exclamation point' calls attention to features for which you should read the enclosed literature closely to prevent operating and maintenance problems.

WARNING: To reduce the risk of fire or electric shock, this apparatus should not be exposed to rain or moisture and objects filled with liquids, such as vases, should not be placed on this apparatus.

CAUTION: To prevent electric shock, match wide blade of plug to wide slot, fully insert.

Important Safety Instructions

- 1 Read these instructions.
- 2 Keep these instructions.
- 3 Heed all warnings.
- 4 Follow all instructions.
- 5 Do not use this apparatus near water.

- 6 Clean only with dry cloth.
- 7 Do not block any ventilation openings. Install in accordance with the manufacturer's instructions.
- 8 Do not install near any heat sources such as radiators, heat registers, stoves, or other apparatus (including amplifiers) that produce heat.
- 9 Do not defeat the safety purpose of the polarized or grounding-type plug. A polarized plug has two blades with one wider than the other. A grounding type plug has two blades and a third grounding prong. The wide blade or the third prong are provided for your safety. If the provided plug does not fit into your outlet, consult an electrician for replacement of the obsolete outlet.
- 10 Protect the power cord from being walked on or pinched, particularly at plugs, convenience receptacles, and the point where they exit from the apparatus.
- 11 Only use attachments/accessories specified by the manufacturer.
- 12 Use only with the cart, stand, tripod, bracket, or table specified by the manufacturer or sold with the apparatus. When a cart is used, use caution when moving the cart/apparatus combination to avoid injury from tip-over.



- 13 Unplug this apparatus during lightning storms or when unused for long periods of time.

- ⑭ Refer all servicing to qualified service personnel. Servicing is required when the apparatus has been damaged in any way, such as power-supply cord or plug is damaged, liquid has been spilled or objects have fallen into the apparatus, the apparatus has been exposed to rain or moisture, does not operate normally, or has been dropped.
- ⑮ **Battery usage CAUTION** – To prevent battery leakage which may result in bodily injury, property damage, or damage to the unit:
- Install all batteries correctly, + and - as marked on the unit.
 - Do not mix batteries (old and new or carbon and alkaline, etc.).
 - Remove batteries when the unit is not used for a long time.
 - Batteries (battery pack or batteries installed) shall not be exposed to excessive heat such as sunshine, fire or the like.
- ⑯ **Apparatus shall not be exposed to dripping or splashing.**
- ⑰ **Do not place any sources of danger on the apparatus (e.g. liquid filled objects, lighted candles).**
- ⑱ **Where the plug of the Direct Plug-in Adapter is used as the disconnect device, the disconnect device shall remain readily operable.**



Warning

- Never remove the casing of this apparatus.
- Never lubricate any part of this apparatus.
- Never place this apparatus on other electrical equipment.

Notice

Any changes or modifications made to this device that are not expressly approved by WOOX Innovations may void the user's authority to operate the equipment.

Notice for the USA

This equipment has been tested and found to comply with the limits for a Class B digital device, pursuant to part 15 of the FCC Rules.

These limits are designed to provide reasonable protection against harmful interference in a residential installation. This equipment generates, uses, and can radiate radio frequency energy and, if not installed and used in accordance with the instruction manual, may cause harmful interference to radio communications. However, there is no guarantee that interference will not occur in a particular installation. If this equipment does cause harmful interference to radio or television reception, which can be determined by turning the equipment off and on, the user is encouraged to try to correct the interference by one or more of the following measures:

- Relocate the receiving antenna.
- Increase the separation between equipment and receiver.
- Connect the equipment into an outlet on a circuit different from that to which the receiver is connected.
- Consult the dealer or an experienced radio/TV technician for help.

Disposal of your old product

Your product is designed and manufactured with high quality materials and components, which can be recycled and reused. Never dispose of your product with other household waste. Please inform yourself about the local rules on the separate collection of electrical and electronic products and batteries. The correct disposal of these products helps prevent potentially negative consequences on the environment and human health.

Your product contains batteries, which cannot be disposed of with normal household waste. Please inform yourself about the local rules on separate collection of batteries. The correct disposal of batteries helps prevent potentially negative consequences on the environment and human health.

Please visit www.recycle.philips.com for additional information on a recycling center in your area.

Always bring your product to a professional to remove the built-in battery.

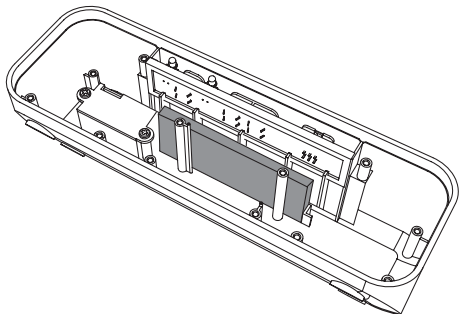

Environmental information

All unnecessary packaging has been omitted. We have tried to make the packaging easy to separate into three materials: cardboard (box), polystyrene foam (buffer) and polyethylene (bags, protective foam sheet.)

Your system consists of materials which can be recycled and reused if disassembled by a specialized company. Please observe the local

regulations regarding the disposal of packaging materials, exhausted batteries and old equipment.



**Be responsible
Respect copyrights**

The making of unauthorized copies of copy-protected material, including computer programs, files, broadcasts and sound recordings, may be an infringement of copyrights and constitute a criminal offence. This equipment should not be used for such purposes.



Note

- The type plate is located on the bottom of the apparatus.

2 Your Bluetooth Speaker

Congratulations on your purchase, and welcome to Philips! To fully benefit from the support that Philips offers, register your product at www.philips.com/welcome.

Introduction

With this speaker, you can enjoy audio from the compatible Bluetooth device or other audio devices.

What's in the box

Check and identify the contents of your package:

- Main unit
- 1 x USB cable
- Short user manual

Overview of the main unit

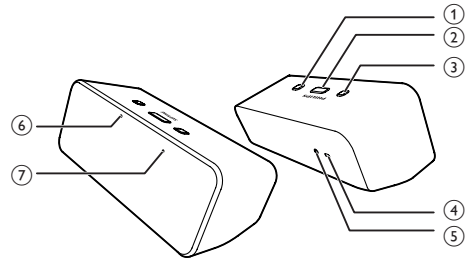

- ① ON/OFF**
 - Turn on/off the unit.
- ② + / -**
 - Adjust volume.
- ③ ►||**
 - Press to play/pause in Bluetooth mode.
 - Press for 2s to wake up your speaker from standby mode.
 - Press for 8s to erase all connection information stored on Bluetooth module.
- ④ DC IN 5V-1A**
 - Charge your Bluetooth speaker through the USB cable.
- ⑤ MP3-LINK**
 - Connect an audio device.
- ⑥ Built-in battery indicator**
 - Steadily on when charging.
 - Flashes when the battery level is low.
- ⑦ Bluetooth indicator**
 - Steadily on when the speaker is connected with Bluetooth compatible device.
 - Flashes when disconnected Bluetooth pairing.

3 Get started

! Caution

- Use of controls, adjustments, or performance of procedures other than herein may result in hazardous radiation exposure or other unsafe operation.

Always follow the instructions in this chapter in sequence.

If you contact Philips, you will be asked for the model and serial number of this apparatus. The model number and serial number are on the bottom of the apparatus. Write the numbers here:

Model No. _____

Serial No. _____

Connect power

! Caution

- Risk of product damage! Make sure that the power supply voltage corresponds to the voltage printed on the back of the speaker.

Connect the AC power adaptor(not supplied) to:

- the power supply socket on the back of the speaker.
- the wall power outlet.

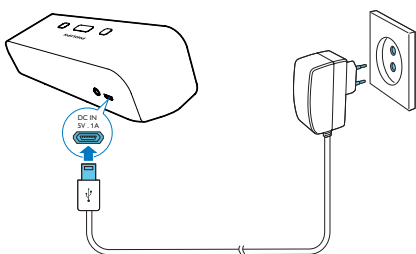

Built-in Battery

The speaker can also operate on built-in rechargeable battery.

To recharge the built-in battery:

- Connect the speaker to the power supply.

≡ Note

- Use only the supplied USB cable to charge the battery.

Turn on

- Switch **ON/OFF** on the speaker to the **ON** position.
↳ The Bluetooth indicator flashes (blue).

Switch to standby mode

The speaker switches to standby mode in the following situations.

- **In Bluetooth mode:** no audio signal from your Bluetooth device over 15 minutes.
- **In MP3 link mode:** no audio signal detected over 15 minutes.
- The battery level is low.

≡ Note

- The Bluetooth connection will be terminated when the speaker enters standby mode, you can wake up the speaker by hold **▶|||** for 2 seconds.

4 Play

Play from a Bluetooth device

You can listen to a Bluetooth device through this speaker:

Note

- The effective operation range between the speaker and your Bluetooth device is approximately 10 meters (30 feet).

- 1 Switch **ON/OFF** to turn on Bluetooth function of the speaker:
↳ The Bluetooth indicator flashes.
- 2 Activate the Bluetooth function in your Bluetooth device (see the device user manual).
- 3 Select "PHILIPS SBT75" on your device for pairing.
↳ The speaker gives out 2 beeps and the Bluetooth indicator steadily on.
 - For former devices, you need to input "0000" as pairing password.
- 4 Start music play on your Bluetooth device .

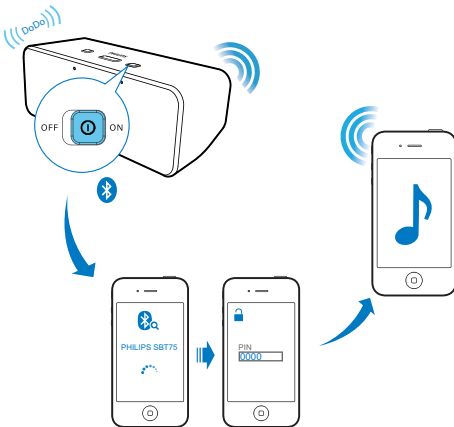

Play from a PC

You can also listen to audio through Bluetooth in PC.

Note

- Make sure that you have installed Bluetooth driver in your PC before pairing.
- The steps below are only for windows 7 operating system. If you use windows XP , refer to windows XP help.

- 1 Switch **ON/OFF** to turn on Bluetooth function of the speaker:
↳ The Bluetooth indicator flashes.
- 2 Activate the Bluetooth function in your PC.
- 3 Add a Bluetooth device in your PC and select "PHILIPS SBT75" for pairing.
↳ The speaker gives out 2 beeps and the Bluetooth indicator steadily on.
- 4 Set "PHILIPS SBT75" as default communication device in your PC.
 - 1). Right click the speaker icon () in the lower right corner of the Windows home screen and select "**Playback Devices**" from the option menu
 - 2). Right click desired speaker and select "**Set as Default communication Device**".
- 5 Start music play on your PC .

Play from an external device

You can also listen to an external audio device through this speaker.

Note

- Your speaker can play under MP3-LINK audio only when the Bluetooth paused or stopped.

- 1 Connect the MP3-LINK cable to:
 - the MP3-LINK socket (3.5mm) on the back of the speaker.
 - the headphone socket on an external device.
- 2 Start to play on the device.

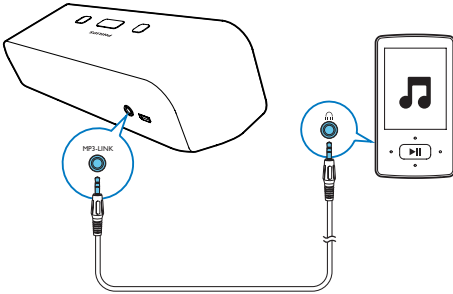

Control play

During play,

- press **VOL +/-** to increase or decrease the volume level.
- press **▶||** to play or pause.
 - ↳ Available only in Bluetooth mode.

5 Product information

Note

- Product information is subject to change without prior notice.

Specifications

Amplifier

Rated Output Power	2 x 2 W RMS
Signal to Noise Ratio	>67 dB
Aux-in Link	600 mV RMS 20 kohm

General information

DC power input	Input: 5V, 1A;
Built-in battery	3.7VDC, 1000mAh
Dimensions - Main Unit (W x H x D)	184 x 62 x 63mm
Weight- Main Unit	0.388 kg

6 Troubleshooting



Warning

- Never remove the casing of this apparatus.

To keep the warranty valid, never try to repair the system yourself.

If you encounter problems when using this apparatus, check the following points before requesting service. If the problem remains unsolved, go to the Philips web site (www.philips.com/welcome). When you contact Philips, ensure that the apparatus is nearby and the model number and serial number are available.

No power

- When use build-in battery only, make sure that the power is sufficient.
- When use AC power plug, make sure that the plug is connected properly, and there is power at the AC outlet.

No sound

- Adjust the volume.

No response from the speaker

- Restart the speaker.



Specifications are subject to change without notice

2014 © WOOX Innovations Limited. All rights reserved.

Philips and the Philips' Shield Emblem are registered trademarks of Koninklijke Philips N.V. and are used by WOOX Innovations Limited under license from Koninklijke Philips N.V.

SBT75_85_UM_V2.0

