

Always there to help you

Register your product and get support at
www.philips.com/support



AJ3250S



User manual

PHILIPS

Contents

1	Important	3
----------	------------------	----------

2	Your clock radio	3
	Introduction	3
	What's in the box	3
	Overview of the clock radio	4

3	Get started	5
	Install battery	5
	Connect power	5
	Turn on	5
	Set time	5

4	Listen to FM radio	6
	Tune to FM radio stations	6
	Store FM radio stations in memory	6
	Select a preset radio station	6
	Adjust volume	6

5	Other features	7
	Charge your mobile devices	7
	Set alarm timer	8
	Set sleep timer	8

6	Product information	9
	Specifications	9

7	Troubleshooting	9
----------	------------------------	----------

8	Notice	10
----------	---------------	-----------

1 Important

Warning

- Never remove the casing of this clock radio.
 - Never lubricate any part of this clock radio.
 - Never place this clock radio on other electrical equipment.
 - Keep this clock radio away from direct sunlight, naked flames or heat.
 - Make sure that you always have easy access to the power cord, plug or adaptor to disconnect the clock radio from the power.
-
- Make sure that there is enough free space around the product for ventilation.
 - Battery usage **CAUTION** – To prevent battery leakage which may result in bodily injury, property damage, or damage to the clock radio:
 - Install the battery correctly, + and - as marked on the clock radio.
 - Do not mix batteries (old and new or carbon and alkaline, etc.).
 - Remove the battery when the clock radio is not used for a long time.
 - The battery shall not be exposed to excessive heat such as sunshine, fire or the like.
 - Use only power supplies listed in the user manual.
 - The clock radio shall not be exposed to dripping or splashing.
 - Do not place any sources of danger on the clock radio (e.g. liquid filled objects, lighted candles).
 - Where the plug of the Direct Plug-in Adapter is used as the disconnect device, the disconnect device shall remain readily operable.

2 Your clock radio

Congratulations on your purchase, and welcome to Philips! To fully benefit from the support that Philips offers, register your product at www.philips.com/welcome.

Introduction

With this clock radio, you can

- listen to FM radio;
- charge your mobile devices; and
- set two alarms to ring at different time.

What's in the box

Check and identify the contents of your package. (Fig. 1)

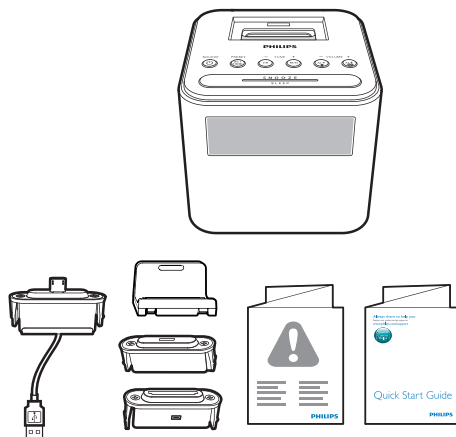

Overview of the clock radio

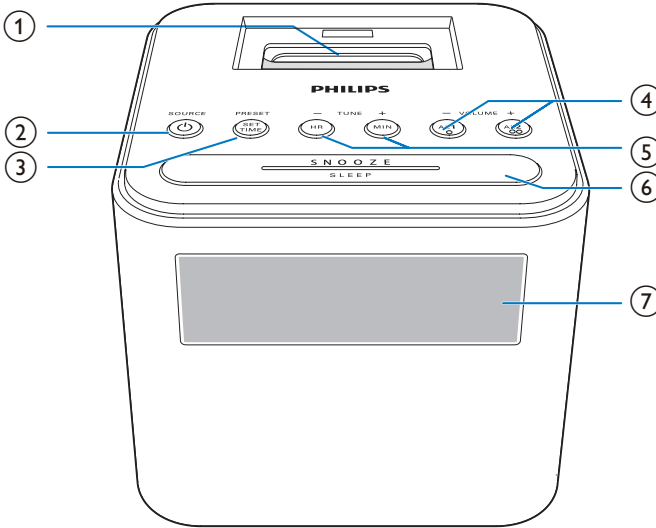

① Dock for charging mobile devices

② **SOURCE**

- Turn on the clock radio.
- Switch the clock radio to standby mode.
- Select FM radio source.

③ **PRESET/SET TIME**

- Store radio stations in memory.
- Select a preset radio station.
- Set time.

④ **AL1/AL2/- VOLUME +**

- Set alarm.
- Adjust volume.

⑤ **HR/MIN/- TUNE +**

- Tune to FM radio stations.
- Set hour and minute.

⑥ **SNOOZE/SLEEP**

- Snooze alarm.
- Set the sleep timer.

⑦ **Display panel**

- Display current status.

3 Get started

Always follow the instructions in this chapter in sequence.

Install battery

The batteries can only back up clock and alarm settings when AC power is disconnected.

! Caution

- The batteries contain chemical substances, so they should be disposed of properly.

- 1 Open the battery compartment.
- 2 Insert 2 AA batteries with correct polarity (+/-) as illustrated.
- 3 Close the battery compartment.

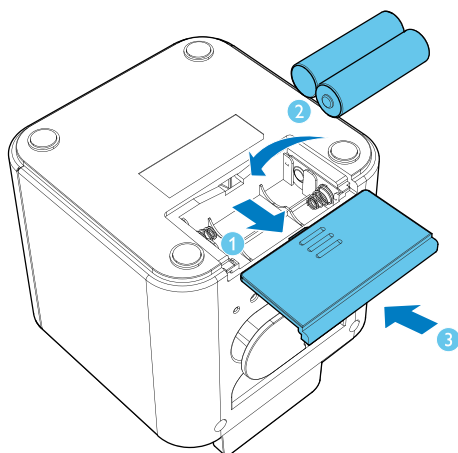

* Tip

- The display backlight is off when AC power is disconnected.

Connect power

! Caution

- Risk of product damage! Make sure that the power voltage corresponds to the voltage printed on the back or underside of the clock radio.
- Risk of electric shock! When you unplug the AC adapter, always pull the plug from the socket. Never pull the cord.

Connect the AC power adaptor to the wall socket.

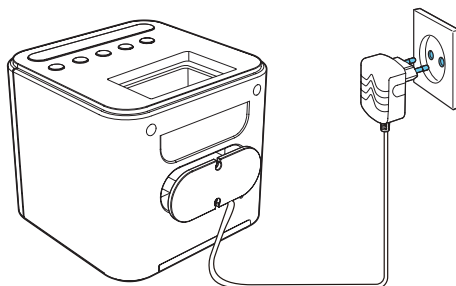

Turn on

Press **⏻** to turn on the clock radio.

- ↳ The clock radio enters FM radio mode.
- Press **⏻** again to switch the product to standby mode.

Set time

☰ Note

- You can only set time in standby mode.

- 1 Press and hold **SET TIME** for two seconds to activate clock setting mode.
↳ The hour and minute digits blink.
- 2 Press **HR** repeatedly to set hour.
- 3 Press **MIN** repeatedly to set minute.
- 4 Press **SET TIME** again to confirm.
↳ The set time is displayed.

4 Listen to FM radio



Note

- Keep the clock radio away from other electronic devices to avoid radio interference.
- For better reception, fully extend and adjust the position of the FM antenna.

Select a preset radio station

In tuner mode, press **PRESET** repeatedly to select a preset station.

Adjust volume

While listening, press **-VOLUME +** to adjust volume.

Tune to FM radio stations

- 1 Press **SOURCE** to turn on FM radio.
- 2 Press and hold **TUNE -** or **TUNE +** for 2 seconds.
 - ↳ The clock radio tunes to a station with strong reception automatically.
- 3 Repeat step 2 to tune to more radio stations.

To tune to a station manually:

In tuner mode, press **TUNE -** or **TUNE +** repeatedly to select a frequency.

Store FM radio stations in memory

You can store up to 10 FM radio stations.

- 1 Tune to an FM radio station.
- 2 Press and hold **PRESET** for two seconds.
 - ↳ The preset number begins to blink.
- 3 Press **TUNE -** or **TUNE +** to select a number.
- 4 Press **PRESET** again to confirm.
- 5 Repeat steps 1 to 4 to store other stations.



Tip

- To remove a pre-stored station, store another station in its place.

5 Other features

Charge your mobile devices

With this clock radio, you can charge your Android-powered mobile phone with a micro USB socket and Apple devices with a lightning or 30-pin connector.

1 Connect the clock radio with your mobile device.

- **For Android-powered mobile device with a micro USB socket:** use the supplied cable to connect the product with the mobile device as illustrated;

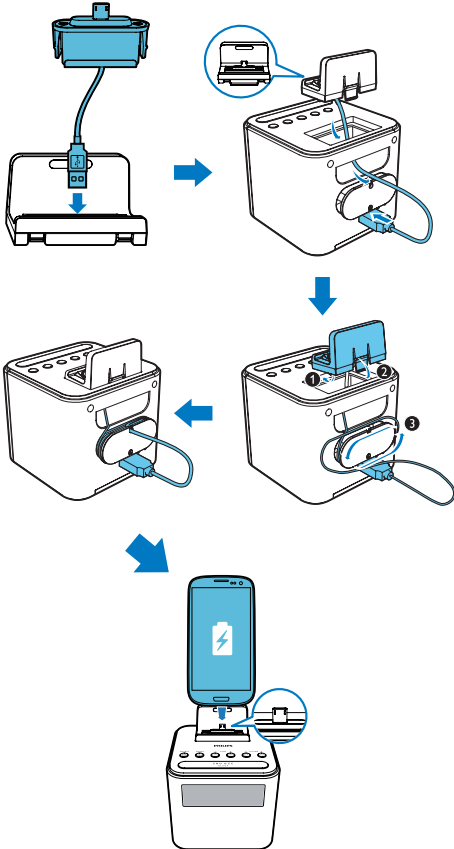

- **For Apple devices with a lightning or 30-pin connector:** use the charging cable of the Apple device (not supplied) to connect the product with the mobile device as illustrated;

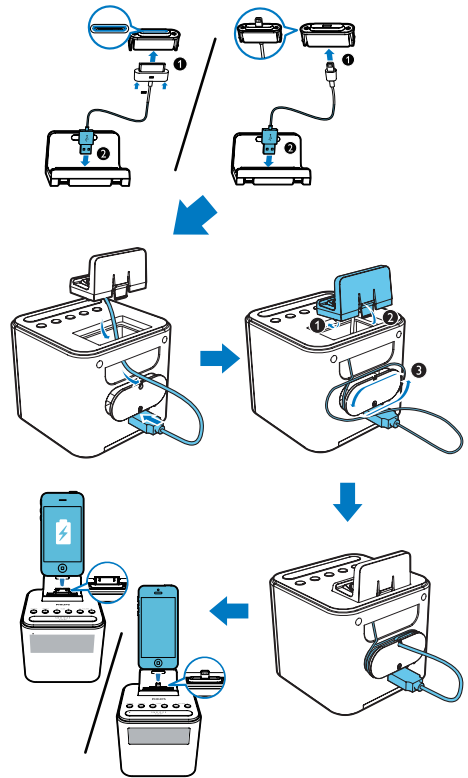

- 2** Connect the clock radio to AC power.
↳ The mobile device begins to charge.

Note

- Gibson Innovations does not guarantee the compatibility of this product with all devices.

Set alarm timer

You can set two alarms to ring at different time.

Note

- You can only set the alarm in standby mode.
- Make sure that you have set the clock correctly.

- 1 Press and hold **AL1** or **AL2** for two seconds to activate alarm setting mode.
↳ The hour and minute digits blink.
- 2 Press **HR** repeatedly to set the hour.
- 3 Press **MIN** repeatedly to set the minute.
- 4 Press **AL1** or **AL2** to confirm.

Tip

- The clock radio exits alarm setting mode when being idle for 10 seconds.

Activate or deactivate the alarm timer

Press **AL1** or **AL2** repeatedly to activate or deactivate the alarm timer:

- ↳ If the alarm timer is activated, the alarm indicator for FM tuner or buzzer is displayed.
- ↳ If the alarm timer is deactivated, the alarm indicator disappears.
- To stop the ringing alarm, press the corresponding **AL1/AL2**.
- ↳ The alarm repeats ringing for the next day.

Note

- If FM tuner is selected and you are listening to radio when alarm time comes, buzzer is activated automatically.
- If buzzer is selected as alarm source, the alarm volume remains at a default level.
- If FM tuner is selected as alarm source, the alarm volume increases gradually and cannot be adjusted.

	Alarm source	Alarm duration
AC power	FM tuner/ Buzzer	30 minutes

Snooze the alarm

When alarm sounds, press **SNOOZE**.

- ↳ The alarm snoozes and repeats ringing nine minutes later.

Set sleep timer

- 1 Turn on the product.
- 2 Press **SLEEP** repeatedly to select a period (in minutes).
↳ The clock radio switches to standby mode automatically after the preset period.

To deactivate the sleep timer:

- Press **SLEEP** repeatedly until **[OFF]** (off) appears.

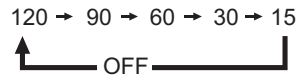

6 Product information

Note

- Product information is subject to change without prior notice.

Specifications

Amplifier

Total Output Power	500 mW
--------------------	--------

Tuner (FM)

Tuning Range	87.5-108 MHz
Tuning Grid	50 KHz
Sensitivity	
- Mono, 26 dB S/N Ratio	<22 dBf
Total Harmonic Distortion	<3%
Signal to Noise Ratio	>50 dBA

General information

AC Power (Power Adapter)	Brand name: Philips;
	Model: S012B0551500E;
	Input: 100-240 V~, 50/60 Hz, max. 400 mA;
	Output: 5.5 V \equiv 1500 mA
USB Port	5 V \equiv 1 A
Operation Power Consumption	9 W
Standby Power Consumption	<1 W
Dimensions: - Main Unit (W x H x D)	112 x 101 x 125 mm
Weight: - Main Unit	0.41 kg

7 Troubleshooting



Warning

- Never remove the casing of this device.

To keep the warranty valid, never try to repair the system yourself.

If you encounter problems when using this device, check the following points before requesting service. If the problem remains unsolved, go to the Philips Web page (www.philips.com/support). When you contact Philips, make sure that the device is nearby and the model number and serial number are available.

No power

- Ensure that the AC power plug of the unit is connected properly.
- Ensure that there is power at the AC outlet.

No sound

- Adjust the volume.

No response from the unit

- Disconnect and reconnect the AC power plug, then turn on the unit again.

Cannot charge your mobile devices

- Make sure that the Apple device or Android-powered device is connected with the clock radio properly.
- Make sure that the clock radio is powered on.

Poor radio reception

- Increase the distance between the product and other electrical appliances.
- Fully extend the antenna.

Alarm does not work

- Set the clock/alarm correctly.

Clock/alarm setting erased

- Power has been interrupted or the power plug has been disconnected.
- Reset the clock/alarm.

8 Notice

Any changes or modifications made to this device that are not expressly approved by Gibson Innovations may void the user's authority to operate the equipment.

Hereby, Gibson Innovations declares that this product is in compliance with the essential requirements and other relevant provisions of Directive 2014/53/EU. You can find the Declaration of Conformity on www.philips.com/support.

packaging materials, exhausted batteries and old equipment.

Note

- The type plate is located on the bottom of the apparatus.

Disposal of your old product



Your product is designed and manufactured with high quality materials and components, which can be recycled and reused.



This symbol on a product means that the product is covered by European Directive 2012/19/EU. Inform yourself about the local separate collection system for electrical and electronic products. Follow local rules and never dispose of the product with normal household waste. Correct disposal of old products helps prevent negative consequences for the environment and human health.

Environmental information

All unnecessary packaging has been omitted. We have tried to make the packaging easy to separate into three materials: cardboard (box), polystyrene foam (buffer) and polyethylene (bags, protective foam sheet.)

Your system consists of materials which can be recycled and reused if disassembled by a specialized company. Please observe the local regulations regarding the disposal of



Specifications are subject to change without notice.

Copyright © 2015 Gibson Innovations Limited. Revised Edition © 2017

This product has been manufactured by, and is sold under the responsibility of Gibson Innovations Ltd., and Gibson Innovations Ltd. is the warrantor in relation to this product. Philips and the Philips Shield Emblem are registered trademarks of Koninklijke Philips N.V. and are used under license.

AJ3250S_12_UM_V3.0

