

DVD/SACD PLAYER

DVP 7400S

Thank you for choosing Philips.

Need help fast?

Read your User's Manual first for quick tips that make using your Philips product more enjoyable.

If you have read your instructions and still need assistance, you may access our online help at www.philips.com/support



PHILIPS

México

NOM-135-

Es necesario que lea cuidadosamente su instructivo de manejo.

	PRECAUCIÓN - ADVERTENCIA No abrir, riesgo de choque eléctrico	
	ATENCIÓN Verifique que el voltaje de alimentación sea el requerido para su aparato	
Para evitar el riesgo de choque eléctrico, no quite la tapa. En caso de requerir servicio, diríjase al personal calificado.		

Descripción: Leitor de DVD/SACD
Modelo: DVP 7400S
Alimentación: **110-127/220-240 V; ~50-60 Hz**
Consumo: 20 W
Importador: **Philips Mexicana, S.A. de C.V.**
Domicilio: **Av. La Palma No.6,
Col. San Fernando, La Herradura
Huixquilucan, Edo de Mexico
C.P. 52784, Mexico**

Localidad y Tel.: **Tel. 52 69 90 00**

Exportador:
País de Origen:

Nº de Serie: _____

**LEA CUIDADOSAMENTE ESTE INSTRUCTIVO
ANTES DE USAR SU APARATO.**

AVISO IMPORTANTE

Philips Mexicana, S.A. de C.V. no se hace responsable por daños o desperfectos causados por:

- Maltrato, descuido o mal uso, presencia de insectos o roedores (cucarachas, ratones etc.).
- Cuando el aparato no haya sido operado de acuerdo con el instructivo del uso, fuera de los valores nominales y tolerancias de las tensiones (voltaje), frecuencia (ciclaje) de alimentación eléctrica y las características que deben reunir las instalaciones auxiliares.
- Por fenómenos naturales tales como: temblores, inundaciones, incendios, descargas eléctricas, rayos etc. o delitos causados por terceros (choques asaltos, riñas, etc.).

Index

English ----- 6

中文 (繁體) ----- 50

Bahasa Melayu ----- 94

Français ----- 138

Español ----- 182

Português ----- 226

English

中文 (繁體)

Bahasa Melayu

Français

Español

Português



Manufactured under license from Dolby Laboratories, "Dolby", "Pro Logic" and the double-D symbol are trademarks of Dolby Laboratories.

This product incorporates copyright protection technology that is protected by method claims of certain U.S. patents and other intellectual property rights owned by Macrovision Corporation and other rights owners. Use of this copyright protection technology must be authorized by Macrovision Corporation, and is intended for home and other limited viewing uses only unless otherwise authorized by Macrovision Corporation. Reverse engineering or disassembly is prohibited.

The apparatus shall not be exposed to dripping or splashing and that no objects filled with liquids, such as vases, shall be placed on apparatus.

Due to the inconsistency of disc formats provided by various disc manufacturers, your DVD system may require a playability enhancement or upgrade. As DVD technology advances, these enhancements will become common and will be easy to complete. **Go to www.philips.com/support for software upgrade.**

'CONSUMERS SHOULD NOTE THAT NOT ALL HIGH DEFINITION TELEVISION SETS ARE FULLY COMPATIBLE WITH THIS PRODUCT AND MAY CAUSE ARTIFACTS TO BE DISPLAYED IN THE PICTURE. IN CASE OF 525 OR 625 PROGRESSIVE SCAN PICTURE PROBLEMS, IT IS RECOMMENDED THAT THE USER SWITCH THE CONNECTION TO THE 'STANDARD DEFINITION' OUTPUT. IF THERE ARE QUESTIONS REGARDING TV SET COMPATIBILITY WITH THIS MODEL 525p AND 625p DVD PLAYER, PLEASE CONTACT OUR CUSTOMER SERVICE CENTER.'

General Information

Environmental Information

All unnecessary packaging has been omitted. The packaging has been made easy to separate into three materials; cardboard (box), polystyrene foam (buffer) and polyethylene (bags, protective foam sheet).

Your DVD player consists of materials which can be recycled and reused if disassembled by a specialised company. Please observe the local regulations regarding the disposal of packaging materials, exhausted batteries and old equipment.



Windows Media and the Windows logo are trademarks, or registered trademarks of Microsoft Corporation in the United States and/or other countries.



DivX Ultra Certified products: "DivX", DivX Ultra Certified, and associated logos are trademarks of DivX, Inc. and are used under license.

HDMI

HDMI (High Definition Multimedia Interface) is a digital interface that allows pure HD digital video transmission without the loss of image quality. The integrated control bus allows system control between the TV set and connected devices like a digital set top box.

For Customer Use:

Read carefully the information located at the bottom or rear of your DVD Video player and enter below the Serial No. Retain this information for future reference.

Model No. DVP 7400S
Serial No. _____

Laser Safety

This unit employs a laser. Due to possible eye injury, only a qualified service person should remove the cover or attempt to service this device.

NOTE:

Pictures shown maybe different between countries.

CAUTION:

WARNING LOCATION: ON THE BACKPLATE OF THE SET

NEVER MAKE OR CHANGE CONNECTIONS WITH THE POWER SWITCHED ON.

"DTS", and "DTS Digital Surround" are registered trademarks of Digital Theater Systems, Inc.

"DCDi" is a trademark of Faroudja, a division of Genesis Microchip, Inc.



Specifications are subject to change without notice. Trademarks are the property of Koninklijke Philips Electronics N.V. or their respective owners.

LASER

Type	Semiconductor laser InGaAlP (DVD) AlGaAs (CD)
Wave length	658 nm (DVD) 790 nm (CD)
Output Power	7.0 mW (DVD) 10.0 mW (VCD/CD)
Beam divergence	60 degrees

Language Code

Abkhazian	6566	Inupiaq	7375	Pushto	8083
Afar	6565	Irish	7165	Russian	8285
Afrikaans	6570	Íslenska	7383	Quechua	8185
Amharic	6577	Italiano	7384	Raeto-Romance	8277
Arabic	6582	Ivrit	7269	Romanian	8279
Armenian	7289	Japanese	7465	Rundi	8278
Assamese	6583	Javanese	7486	Samoan	8377
Avestan	6569	Kalaallisut	7576	Sango	8371
Aymara	6589	Kannada	7578	Sanskrit	8365
Azerhijani	6590	Kashmiri	7583	Sardinian	8367
Bahasa Melayu	7783	Kazakh	7575	Serbian	8382
Bashkir	6665	Kernewek	7587	Shona	8378
Belarusian	6669	Khmer	7577	Shqip	8381
Bengali	6678	Kinyarwanda	8287	Sindhi	8368
Bihari	6672	Kirghiz	7589	Sinhalese	8373
Bislama	6673	Komi	7586	Slovensky	8373
Bokmål, Norwegian	7866	Korean	7579	Slovenian	8376
Bosanski	6683	Kuanyama; Kwanyama	7574	Somali	8379
Brezhoneg	6682	Kurdish	7585	Sotho; Southern	8384
Bulgarian	6671	Lao	7679	South Ndebele	7882
Burmese	7789	Latina	7665	Sundanese	8385
Castellano, Español	6983	Latvian	7686	Suomi	7073
Catalán	6765	Letzeburgesch;	7666	Swahili	8387
Chamorro	6772	Limburgan; Limburger	7673	Swati	8383
Chechen	6769	Lingala	7678	Svenska	8386
Chewa; Chichewa; Nyanja	7889	Lithuanian	7684	Tagalog	8476
中文	9072	Luxembourgish;	7666	Tahitian	8489
Chuang; Zhuang	9065	Macedonian	7775	Tajik	8471
Church Slav; Slavonic	6785	Malagasy	7771	Tamil	8465
Chuvash	6786	Magyar	7285	Tatar	8484
Corsican	6779	Malayalam	7776	Telugu	8469
Česky	6783	Maltese	7784	Thai	8472
Dansk	6865	Manx	7186	Tibetan	6679
Deutsch	6869	Maori	7773	Tigrinya	8473
Dzongkha	6890	Marathi	7782	Tonga (Tonga Islands)	8479
English	6978	Marshallese	7772	Tsonga	8483
Esperanto	6979	Moldavian	7779	Tswana	8478
Estonian	6984	Mongolian	7778	Türkçe	8482
Euskara	6985	Nauru	7865	Turkmen	8475
Ελληνικά	6976	Navaho; Navajo	7886	Twi	8487
Faroesse	7079	Ndebele, North	7868	Uighur	8571
Français	7082	Ndebele, South	7882	Ukrainian	8575
Frysk	7089	Ndonga	7871	Urdu	8582
Fijian	7074	Nederlands	7876	Uzbek	8590
Gaelic; Scottish Gaelic	7168	Nepali	7869	Vietnamese	8673
Gallegan	7176	Norsk	7879	Volapuk	8679
Georgian	7565	Northern Sami	8369	Walloon	8765
Gikuyu; Kikuyu	7573	North Ndebele	7868	Welsh	6789
Guarani	7178	Norwegian Nynorsk;	7878	Wolof	8779
Gujarati	7185	Occitan; Provençal	7967	Xhosa	8872
Hausa	7265	Old Bulgarian; Old Slavonic	6785	Yiddish	8973
Herero	7290	Oriya	7982	Yoruba	8979
Hindi	7273	Oromo	7977	Zulu	9085
Hiri Motu	7279	Ossetian; Ossetic	7983		
Hrvatski	6779	Pali	8073		
Ido	7379	Panjabi	8065		
Interlingua (International)	7365	Persian	7065		
Interlingue	7365	Polski	8076		
Inuktitut	7385	Português	8084		

Contents

Care and Safety Information

Setup	8
Cleaning discs	8

General Information

Accessories supplied	9
Region codes	9

Connections

Connecting to television	10~12
Using Composite Video sockets (CVBS)	10
Using S-Video sockets	10
Using Component Video sockets (YPbPr)	11
Scan Mode (Interlace/Progressive)	11
Using an accessory RF modulator	12
Connecting the power cord	12

Optional connections

Connecting to HDMI/DVI devices	13
Using HDMI (High Definition Multimedia Interface) sockets	13
Connecting to an stereo system	14
Stereo system has Dolby Pro Logic or Right/Left Audio In sockets	14
Connecting to a digital AV receiver	14
Receiver has a PCM, Dolby Digital or MPEG decoder	14
Connecting to a Multi-channel receiver	15
Receiver has multi-channel audio In sockets	15

Product Overview

Front panel	16
Rear panel	17
Remote Control	18

Getting Started

Step 1: Inserting Batteries	19
Using the remote control to operate the system	19
Step 2: Finding your viewing channel	19
Step 3: Selecting the matching color system	20
Step 4: Setting the language	21
On-screen display (OSD) language	21
Audio, Subtitle and Disc menu languages	21
Step 5: Setting the speakers' channel	22

Playback from Disc

Playable discs	23
Supported formats	23

Playback Features

Starting disc playback	24
Basic playback control	24
Pausing playback	24
Selecting title/chapter/track	24
Stopping playback	24
Operations for video playback (DVD/VCD/SVCD)	25
Using the Disc Menu	25
Zooming in	25
Resuming playback from the last stopped point	25
Slow Motion	25
Forward / Reverse Searching	25
Selecting various repeat/shuffle functions	26
Repeat play mode	26

Contents

Repeating a section within a chapter/track.....	26
Shuffle.....	26
Viewing the disc playback information	27~28
Title/Chapter/Track selection	27
Time Search	27
Preview Function.....	28
Special DVD Features.....	28
Playing a Title.....	28
Changing the Audio Language.....	28
Subtitle	28
Special VCD and SVCD Feature	29
Playback Control (PBC)	29
Playing a Super Audio CD (SACD).....	29
Playing a DivX disc	30
Playing MP3/WMA/JPEG/Kodak Picture CD	31~32
General Operation	31
Playback selection	31
Preview (JPEG).....	31
Zoom picture (JPEG)	32
Playback with multi-angles (JPEG).....	32
Scan Effect.....	32
Playing MP3/WMA music and JPEG picture simultaneously	32
DVD Menu Options	
Using the General setup menu.....	33~35
Locking/Unlocking disc for viewing.....	33
Program play (not for Picture CD/MP3/WMA/DivX/SACD).....	34
OSD Language.....	34
Screen Saver - turning on/off	34
Sleep.....	35
DivX Registration Code.....	35
Using the Audio setup menu	36~38
Analog Output	36
Digital Audio Setup	37
HDMI Audio	37
Speaker Setup.....	38
CD Upsampling.....	38
Night Mode	38
Lip Sync	38
Using the Video setup menu.....	39~42
TV Type.....	39
Setting the TV Display	39
Picture Setting.....	40
Advance Picture	41~42
Using the Preference setup menu	42~45
Audio, Subtitle, Disc Menu settings	43
Parental	43
PBC (Playback Control)	44
MP3/JPEG Menu – turning on/off.....	44
Changing the Password.....	44
Restoring the original settings.....	45
Setting the DivX Subtitle.....	45
Others	
Troubleshooting	46~47
Specifications	48
Glossary	49

Care and Safety Information

DANGER!

High voltage! Do not open the device. You run the risk of getting an electric shock.

The machine does not contain any user-serviceable parts. Please leave all maintenance work to qualified personnel.

Setup

Finding a suitable location

- Place the set on a flat, hard and stable surface. Do not place the set on a carpet.
- Do not position the set on top of other equipment that might heat it up (e.g., receiver or amplifier).
- Do not put anything under the set (e.g., CDs, magazines).
- Install this unit near the AC outlet and where the AC power plug can be reached easily.

Space for ventilation

- Place the apparatus in a location with adequate ventilation to prevent internal heat build up. Allow at least 10 cm (4.0") clearance from the rear and the top of the set and 5cm (2.0") from the left and right to prevent overheating.

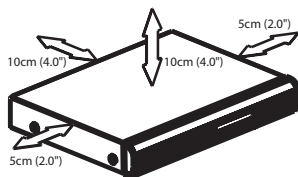

Avoid high temperatures, moisture, water and dust

- Apparatus shall not be exposed to dripping or splashing.
- Do not place any sources of danger on the apparatus (e.g., liquid filled objects, lighted candles).

Cleaning discs

Some problems occur because the disc inside the recorder is dirty (frozen picture, sound disruptions, picture distortions). To avoid these problems, discs should be cleaned on a regular basis.

To clean a disc, use a micro fibre cleaning cloth and wipe the disc from the center to the edge in a straight line.

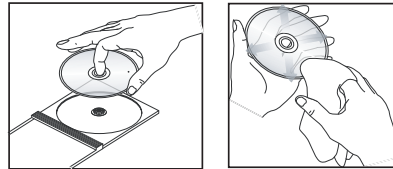

CAUTION!

Do not use solvents such as benzene, thinner, commercially available cleaners, or anti-static sprays intended for analog discs. Since the optical unit (laser) of the DVD player operates at a higher power than regular DVD or CD players, cleaning CDs intended for DVD or CD players may damage the optical unit (laser). Therefore, refrain from using a cleaning CD.

General Information

Accessories supplied

Composite video cable (yellow) and Audio cables (white, red)

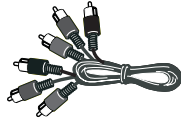

Remote control and two AA batteries

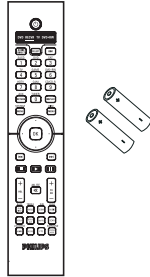

AC power cord



Region codes

This DVD player is designed to support the Region Management System. Check the regional code number on the disc package. If the number does not match the player's region number (see table below), the player may be unable to playback the disc.

Tips:

- It may not be possible to play CD-R/RW or DVD-R/RW in all cases due to the type of disc or condition of the recording.
- If you are having trouble playing a certain disc, remove the disc and try a different one. Improperly formatted disc will not play on the DVD player.

Region	Discs that can be played	
U.S.A. and Canada regions		
U.K and Europe regions		
Asia Pacific, Taiwan, Korea		
Australia, New Zealand, Latin America		
Russia and India regions		
China, Calcos Islands, Walls and Futuna Islands		

Connections

Connecting to television

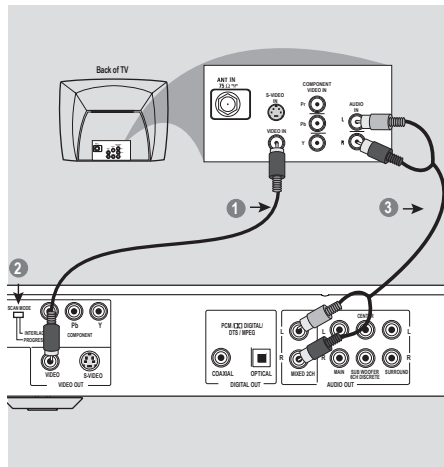

IMPORTANT!

- You only need to make one video connection from the following options, depending on the capabilities of your television.
- Connect the DVD player directly to the television.

Using Composite Video sockets (CVBS)

- 1 Use the composite video cable (yellow) to connect the DVD player's CVBS (VIDEO) socket to the video input jack (or labeled as A/V In, Video In, Composite or Baseband) on the television (cable supplied).
- 2 Set the SCAN MODE switch to INTERLACE.
- 3 To hear sound of this DVD player through your TV, use the audio cables (white/red) to connect AUDIO OUT (L/R) sockets of the DVD player to the corresponding AUDIO IN sockets on the television (cable supplied).

TIPS: Before making or changing any connections, make sure that all the devices are disconnected from the power outlet.

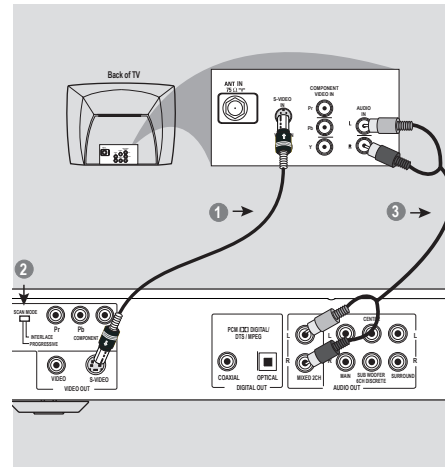

IMPORTANT!

- S-Video connections provides better picture quality than composite video. This option must be available on your TV.

Using S-Video sockets

- 1 Use the S-Video cable to connect the DVD player's S-Video sockets to the S-VIDEO input sockets (or labeled as Y/C or S-VHS) on the television (cable not supplied).
- 2 Set the SCAN MODE switch to INTERLACE.
- 3 To hear sound of this DVD player through your TV, use the audio cables (white/red) to connect AUDIO OUT (L/R) sockets of the DVD player to the corresponding AUDIO IN sockets on the television (cable supplied).

Connections (continued)

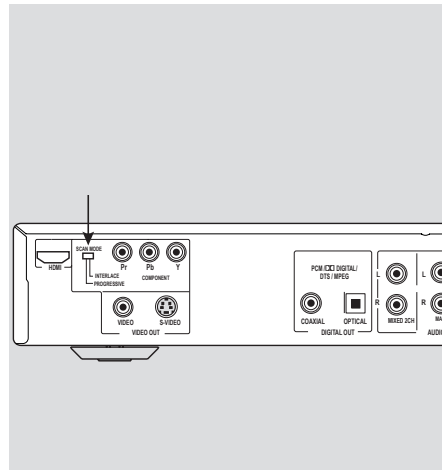
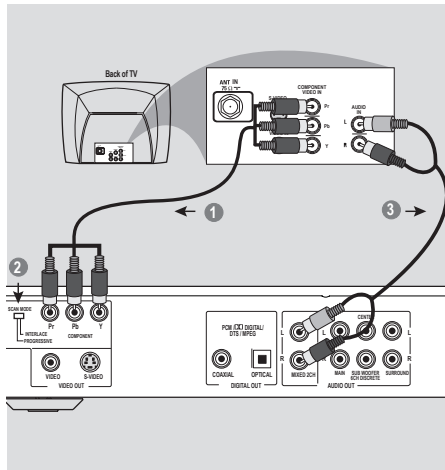

IMPORTANT!

– The progressive scan video quality is only possible when using YPbPr and a progressive scan television is required.

Using Component Video sockets (YPbPr)

- 1 Use the component video cables (red/blue/green) to connect the DVD player's YPbPr sockets to the component video input sockets (or labeled as YPbPr) on the television (cable not supplied).
- 2 Set the SCAN MODE switch to PROGRESSIVE.
- 3 To hear sound of this DVD player through your TV, use the audio cables (white/red) to connect AUDIO OUT (L/R) sockets of the DVD player to the corresponding AUDIO IN sockets on the television (cable supplied).

TIPS: Before making or changing any connections, make sure that all the devices are disconnected from the power outlet.

Scan Mode (Progressive or Interlace selector)

This switch will change the type of signal output from the Component Video Out on the DVD player.

Interlace:

Select { **Interlace** } when connected to a standard (interlace format) TV.

Progressive:

Select { **Progressive** } when you have a TV that can accept progressive signals (480/576p) to enjoy accurate color reproduction and high quality images.

Tips:

- In Progressive mode, 4:3 aspect images are stretched horizontally on the wide screen TV. Change the TV screen's aspect ratio settings in {PSCAN FORMAT} according to your own preference.
- Some TVs and projectors are not compatible with this DVD player. If picture distorted during progressive signals, switch the SCAN MODE to {Interlace}.

Connections (continued)

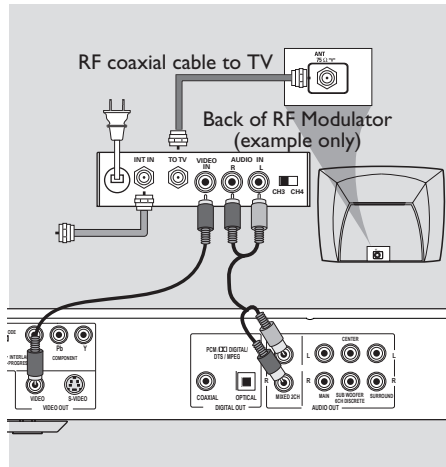

IMPORTANT!

– If your television only has a single Antenna In jack (or labeled as 75 ohm or RF In,) you will need an RF modulator in order to view the DVD playback on the television. See your electronics retailer or contact Philips for details on RF modulator availability and operations.

Using an accessory RF modulator

- 1 Use the composite video cable (yellow) to connect the DVD player's CVBS jack to the video input jack on the RF modulator.
- 2 Use the RF coaxial cable (not supplied) to connect the RF modulator to your television's RF jack.
- 3 To hear sound of this DVD player through your TV, use the audio cables (white/red) to connect AUDIO OUT (L/R) sockets of the DVD player to the corresponding AUDIO IN sockets on the RF modulator (cable supplied).

TIPS: Before making or changing any connections, make sure that all the devices are disconnected from the power outlet.

Connecting the power cord

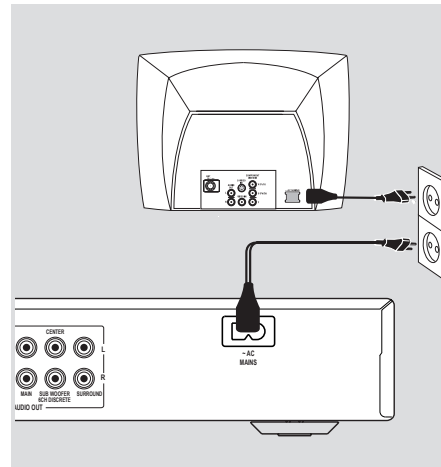

After everything is connected properly, plug in the AC power cord to the power outlet.

Never make or change any connections with the power switched on.

When no disc is loaded, press **STANDBY ON** on the DVD player front panel.

Connecting to a HDMI/DVI device

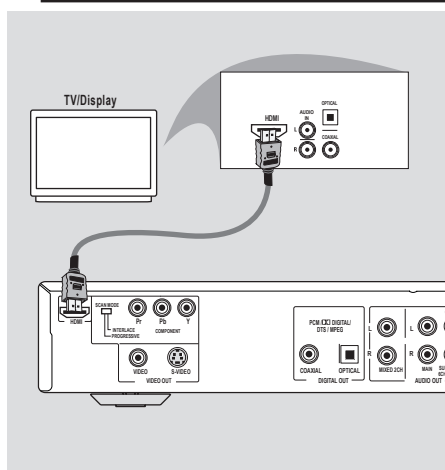

Using HDMI (High Definition Multimedia Interface) sockets

- HDMI connects untouched and uncompressed digital transmissions for the highest and crispest sound/image quality.
 - It has plug and play capability using only one cable for both audio/video output.
 - Use a HDMI cable (not supplied) to connect the HDMI OUT on the DVD player to HDMI IN on a HDMI compatible device (e.g.; PC, DVD player, Set Top Box).
 - It may take a while for the DVD player and input device to communicate and initialise.
 - Playback starts automatically.
- Proceed to page 37 for detailed HDMI setup.

Tip:

– If you are using the HDMI as audio source, make sure that {Digital Output} is set to {PCM Only} (see page 37).

TIPS: Before making or changing any connections, make sure that all the devices are disconnected from the power outlet.

Optional connections (continued)

Connecting to an stereo system

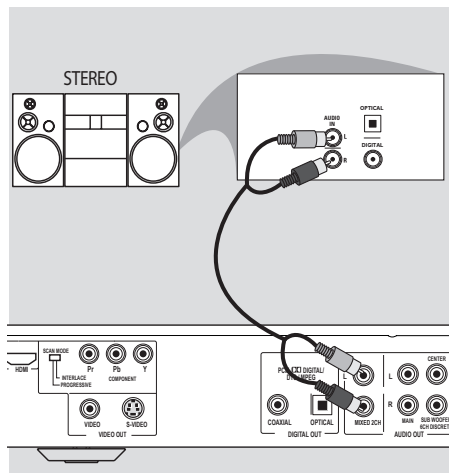

Stereo system has Dolby Pro Logic or right/ left Audio In sockets

- 1 Select one of the video connections (CVBS VIDEO IN, S-VIDEO or COMPONENT VIDEO IN) depending on the options available on your TV.
- 2 Switch the SCAN MODE selector to INTERLACE for CVBS or S-VIDEO connection.
- 3 Switch the SCAN MODE selector to PROGRESSIVE for COMPONENT VIDEO connection with a Progressive Scan TV.
- 4 Use the audio cables (white/red) to connect AUDIO OUT (L/R) sockets of the DVD Player to the corresponding AUDIO IN sockets on the stereo system (cable supplied).

Tip:

– For optimum stereo sound quality, connect Left and Right channel from the Multi-channel output and set {Analog Output} to {Stereo}, see page 36.

TIPS: Before making or changing any connections, make sure that all the devices are disconnected from the power outlet.

Connecting to a digital AV receiver

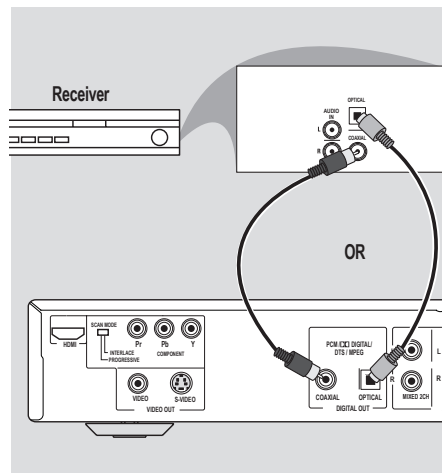

Receiver has a PCM, Dolby Digital or MPEG decoder

- 1 Select one of the video connections (CVBS VIDEO IN, S-VIDEO or COMPONENT VIDEO IN) depending on the options available on your TV.
- 2 Connect the COAXIAL or OPTICAL jack of the DVD player to the corresponding Digital Audio In socket on your receiver (cable not supplied).
- 3 Set the DVD player's {Digital Output} to {PCM-Only} or {All} depending on the capabilities of your receiver (see page 37 {Digital Output}).

Tip:

– If the audio format of the Digital Output does not match the capabilities of your receiver, the receiver will produce a strong, distorted sound or no sound at all.

Optional connections (continued)

Connecting to a Multi-channel receiver

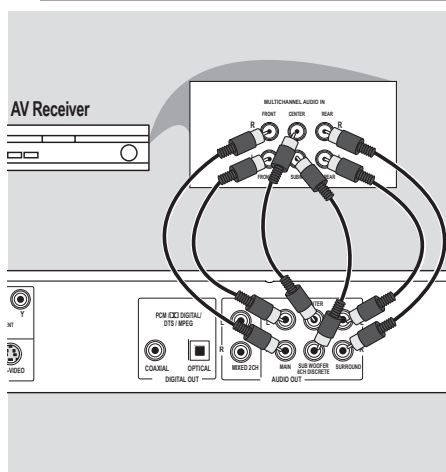

Receiver has multi-channel audio In sockets

- 1 Select one of the video connections (CVBS VIDEO IN, S-VIDEO or COMPONENT VIDEO IN) depending on the options available on your TV.
- 2 Connect the Audio Out Left and Right sockets for Main and Rear speakers to the corresponding input sockets on your receiver (cable not supplied).
- 3 Connect the Audio Out for Center speaker and Subwoofer to the corresponding input sockets on your receiver (cable not supplied).
- 4 Set the DVD player's {Analog Output} to {Multi-channel} to enable playback of discs recorded in multi-channel (see page 36 {Analog Output}).

Tip:

- If the subwoofer is equipped with its own amplifier, the subwoofer connection should be connected directly to the subwoofer.

TIPS: Before making or changing any connections, make sure that all the devices are disconnected from the power outlet.

Product Overview

Front Panel

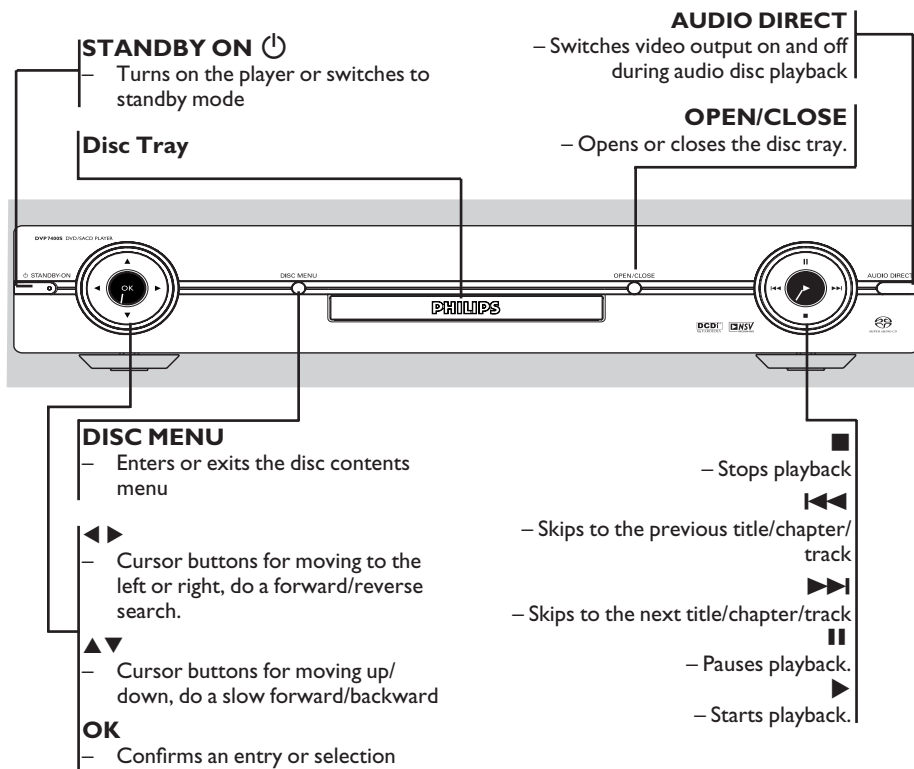

Product Overview (continued)

Rear Panel

English

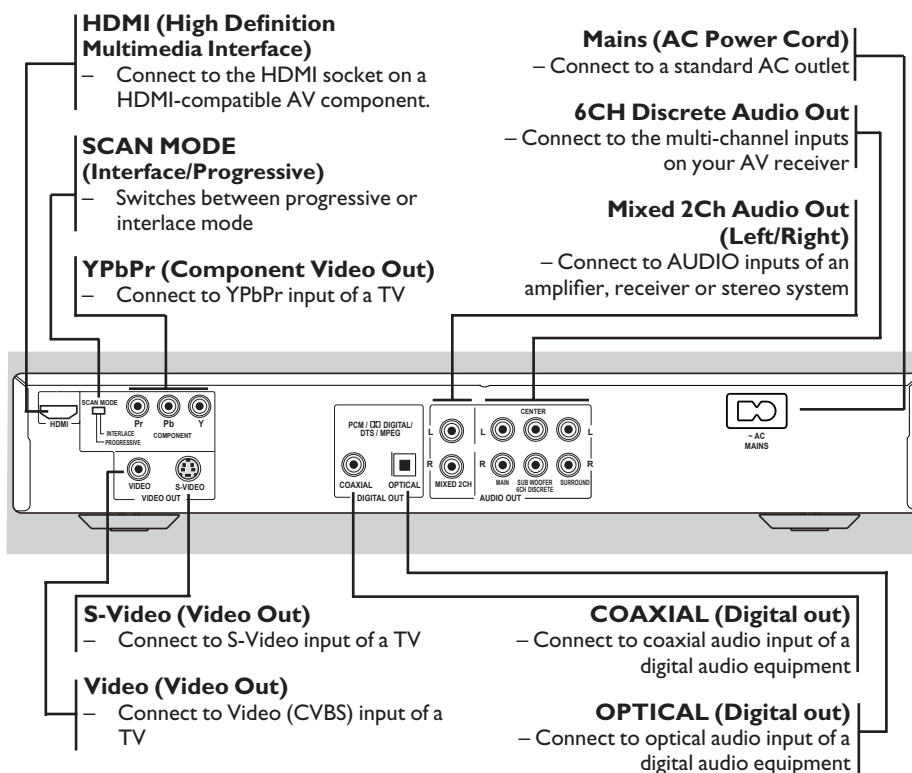

Caution: Do not touch the inner pins of the jacks on the rear panel. Electrostatic discharge may cause permanent damage to the system.

Product Overview (continued)

Remote Control

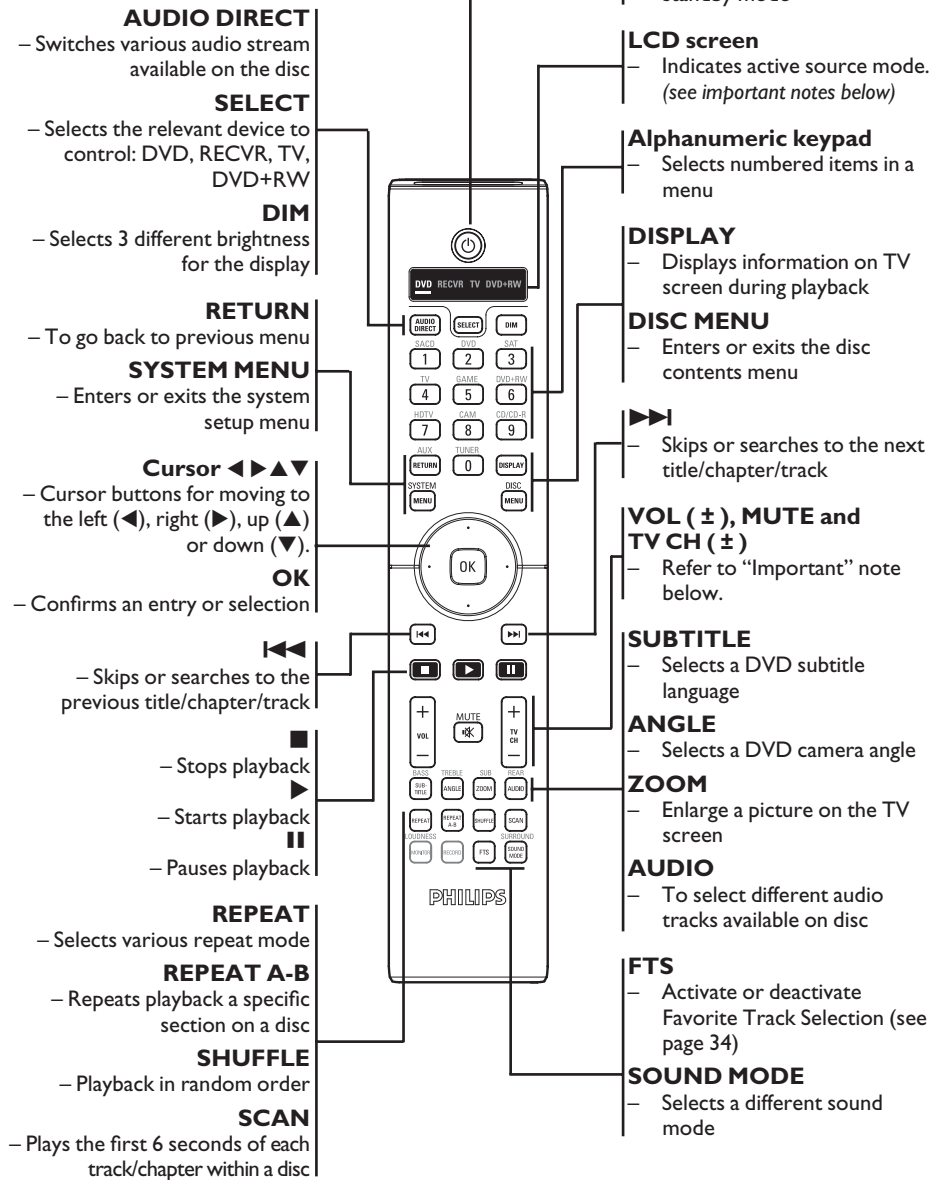

Important!

- This remote is a Philips system remote which is capable of controlling other Philips equipment (e.g., Recorder, TV or DVD-RW player).
- Refer to user manuals for other equipment as necessary.

Getting Started

Step 1 : Inserting Batteries

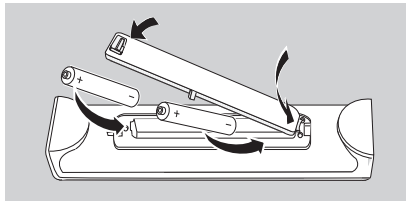

- 1 Open the battery compartment.
- 2 Insert two batteries type R06 or AA, following the indications (+ -) inside the compartment.
- 3 Close the cover.

CAUTION!

- Remove batteries if they are exhausted or if the remote is not to be used for a long time.
- Do not use old and new or different types of batteries in combination.
- Batteries contain chemical substances, so they should be disposed of properly.

Using the remote control to operate the system

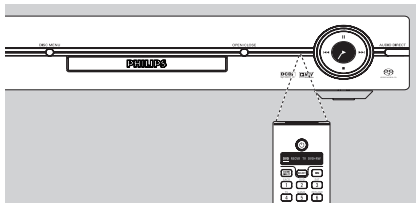

- 1 Aim the remote control directly at the remote sensor (IR) on the front panel.
- 2 Do not put any objects between the remote control and the DVD player while operating the DVD player.

Step 2 : Finding your viewing channel

- 1 Press **STANDBY-ON**  on the DVD player to turn it on.
- 2 Turn on the TV and set it to the correct video-in channel. You should see the blue DVD background screen.
 - Usually these channel are between the lowest and highest channels and may be called FRONT, A/V IN, VIDEO. See your TV's manual for more details.
 - Or, you may go to channel 1 on your TV, then press the Channel down button repeatedly until you see the Video In channel.
 - Or, the TV remote control may have a button or switch that chooses different video modes.
 - Or, set the TV to channel 3 or 4 if you are using an RF modulator.
- 3 If you are using external equipment, (e.g. audio system or receiver), turn it on and select the appropriate input source for the DVD player output. Refer to the equipment user's manual for detail.

Getting Started (continued)

Step 3 : Selecting the matching color system

The color system of the DVD player, disc and TV should match in order for the disc to play. Before changing the TV system, determine the color system of your TV.

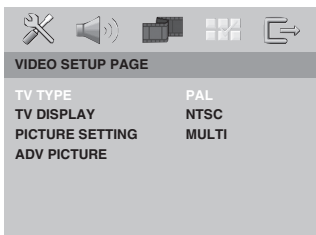

- 1 Press **SYSTEM MENU**.
- 2 Press **▶** repeatedly to select { **Video Setup Page** }.
- 3 Press **▲ ▼** to select { **TV Type** }, then press **▶**.
- 4 Use **▲ ▼** to select one of the options below:

{ **PAL** }

Select this if the connected TV has the PAL color system. It will change the video signal of an NTSC disc and output it to PAL format.

{ **NTSC** }

Select this if the connected TV has the NTSC color system. It will change the video signal of a PAL disc and output it to NTSC format.

{ **Multi** }

Select this if the connected TV is compatible with both NTSC and PAL (multi-system). The output format will be in accordance with the video signal of the disc.

- 5 Select a setting and press **OK**.
→ Follow the instructions show on the TV to confirm the selection (if any).

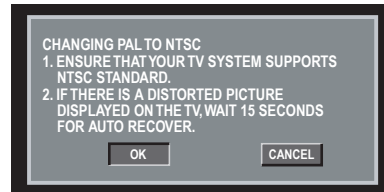

- 6 Press **◀** to highlight { **OK** } and press **OK** to confirm.

Tips:

- Before changing the current TV color setting, ensure that your TV supports the 'selected TV System'.
- If there is no proper picture on your TV, wait for 15 seconds for auto recovery.

TIPS: The underlined option is the factory default setting.
Press **◀** to go back to previous menu item. Press **SYSTEM MENU** to exit the menu item.

Getting Started (continued)

Step 4 : Setting the language

The language options are different depending on your country or region. It may not correspond to the illustrations shown on the user manual.

On-screen display (OSD) language

Select this to change the language of this DVD player screen display menu.

The menu language (on-screen display) for the system will remain as you set it.

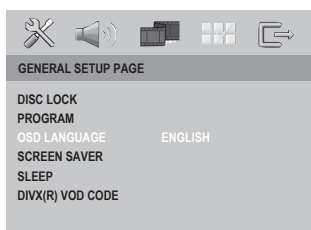

- 1 Press **SYSTEM MENU**.
- 2 Press **▶** repeatedly to select { **General Setup Page** }.
- 3 Press **▲ ▼** to select { **OSD Language** }, then press **▶**.
- 4 Use **▲ ▼** to select a language and press **OK** to confirm.

Audio, Subtitle and Disc menu languages

You can choose your preferred language or soundtrack from audio, subtitles and DVD menu languages. If the selected language is not available on the disc, the disc's default language will be used instead.

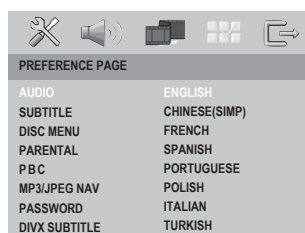

- 1 Press **SYSTEM MENU**.
- 2 Press **▶** repeatedly to select { **Preference Page** }.
- 3 Press **▲ ▼** to highlight one of the options below, then press **▶**.
 - { **Audio** }
Select this to change disc soundtrack language.
 - { **Subtitle** }
Select this to change the subtitle language.
 - { **Disc Menu** }
Select this to change the language of the disc menu.
- 4 Use **▲ ▼** to select a language and press **OK** to confirm.

If the language you want is not in the list, then select {OTHERS}.
Use the alpha-numeric keypads (0-9) on the remote to enter the 4-digit language code 'XXXX' (see page 5 'Language Code') and press **OK**.
- 5 Repeat steps 3 - 4 for other language settings.

TIPS: The underlined option is the factory default setting.
Press **◀** to go back to previous menu item. Press **SYSTEM MENU** to exit the menu item.

Getting Started (continued)

Step 5 : Setting the speakers' channels

You can adjust the delay time (for center and rear only) and volume level for individual speakers. These adjustments let you optimize the sound according to your surroundings and setup.

Important!

Speaker settings are available for multi-channel outputs.

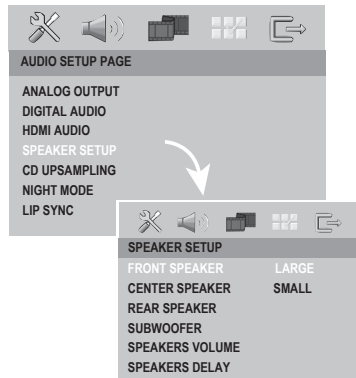

- 1 Press **SYSTEM MENU**.
- 2 Press **▶** repeatedly to select { **Audio Setup Page** }.
- 3 Press **▲ ▼** to select { **Speaker Setup** }, then press **▶**.
- 4 Enter a submenu by pressing **▶**.
- 5 Use **▲ ▼** to select one of the options below:

{ **FRONT SPEAKER, CENTER SPEAKER, REAR SPEAKER** }

[OFF] (only for Center and Rear speakers)
Select when no speakers are connected.

[LARGE]

Select when the connected speakers can produce low frequency signals below 120Hz.

[SMALL]

Select when connected speakers cannot produce low frequency signals below 120Hz.

{ **SUBWOOFER** }

[ON]

Select when a subwoofer is connected.

[OFF]

Select when no subwoofer is connected.

{ **SPEAKERS VOLUME** }

Volume level setting for individual speakers (-6dB ~ +6dB).

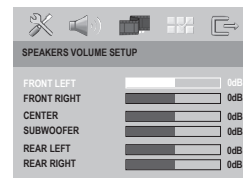

{ **SPEAKERS DELAY** }

Delay time settings in relation to the listening position or distance for center and rear speakers (0MS ~ 15MS).

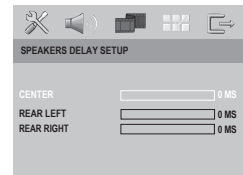

- 6 Press **◀ ▶** to adjust the setting that best suits your surround sound needs.
- 7 Press **OK** to confirm.

Tips:

- Use a longer delay time setting when the rear speakers are closer to the listener than the front speakers.
- A test tone will be automatically generated to help you judge the sound level of each speaker.

TIPS: The underlined option is the factory default setting.
Press **◀** to go back to previous menu item. Press **SYSTEM MENU** to exit the menu item.

Playback from Disc

IMPORTANT!

- If the inhibit icon 'X' or  appears on the TV screen when a button is pressed, it means the function is not available on the current disc or at the current time.
- DVD discs and players are designed with regional restrictions. Before playing a disc, make sure the disc is for the same zone as your player.

Playable discs

Using this DVD player, you can playback on the following discs:

DVD Video (Digital Versatile Disc)



DVD±RW (DVD Rewritable) Audio/Video format or MP3/WMA/JPEG/DivX files.



DVD±R (DVD Recordable) Audio/Video format or MP3/WMA/JPEG/DivX files.



CD-R (CD-Recordable) Audio/Video format or MP3/WMA/JPEG/DivX files.



CD-RW (CD-Rewritable) Audio/Video format or MP3/WMA/JPEG/DivX files.



SACD (Super Audio Compact Disc)



Audio CD (Compact Disc Digital Audio)



Video CD
(Formats 1.0, 1.1, 2.0)



Super Video CD



MP3-Disc



DivX Disc
(DivX 3.1 I, 4.x, 5.x, 6.x and DivX Ultra)



Supported formats

MP3 tracks

- The file extensions has be to be '.mp3.'
- JPEG/ISO format
- Maximum 30 characters display.
- Supported sampling frequencies;
(MPEG-1) 32kHz, 44.1kHz, 48kHz
(MPEG-2) 16kHz, 22.05kHz, 24kHz
- Supported bit-rates;
(MPEG-1) 32 ~ 256 kbps
(MPEG-2) 16 ~ 160 kbps

JPEG pictures

- The file extensions has be to be '.JPG' and not '.JPEG.'
- JPEG/ISO format
- It can only display DCF-standard still pictures or JPEG pictures e.g. TIFF.



DivX movies

- The file extensions has be to be '.AVI,' '.MPG,' '.MPEG,' or '.DIVX.'
- DivX 3.1 I, 4.x, 5.x, 6.x and DivX Ultra
- Q-pel accurate motion compensation
- Global Motion Compensation (GMC) playback.

TIPS: Some discs cannot be played on this DVD player due to the configuration and characteristics of the disc, or due to the condition of recording and authoring software that was used.

Playback Features



Starting disc playback

- 1 Press **SELECT** on the remote control until 'DVD' is lighted on the remote control display (see *remote control*, page 18).
- 2 Turn on the TV to the correct programme number for the DVD player (e.g. 'EXT', '0', 'AV').
- 3 Press **STANDBY-ON**  to turn on the DVD player.
- 4 Press **OPEN CLOSE** on the front of the DVD player.
- 5 Place a disc into the disc tray with the label facing up, then press **OPEN CLOSE**.
→ For double-sided discs, load the side which you want to play facing up.
- 6 Playback may start automatically. If not, press **PLAY** .
- If a disc menu appears on the TV, see page 25 'Using the Disc Menu'.
- If the child lock was activated for the inserted disc, you have to enter your six-digit password (see page 44).
- For more playback features, see pages 24~32.

Basic playback controls

Unless otherwise stated, all operations described are based on Remote Control use.

Pausing playback

- 1 During playback, press **PAUSE**  to pause playback and display a still picture.
→ Sound will be muted.
- 2 Press **PAUSE**  again to select the next picture frame.
- 3 To resume normal playback, press **PLAY**  again.

Selecting title/chapter/track

- Press **◀◀ / ▶▶** or use alphanumeric keypad (0-9) go to the previous or next title/chapter/track.
→ The playback skips to the selected title/chapter/track.
- During repeat playback of a title/chapter/track, pressing **◀◀ / ▶▶** will replay the same title/chapter/track.

Stopping playback

- Press **STOP** .

Tips:

- Screen saver will start automatically if the disc playback is stopped for 15 minutes.
- The player will automatically switch to Power Standby mode if you do not press any buttons for 30 minutes after the disc has stopped playing.

TIPS: The operating features described here might not be possible for certain discs. Always refer to the instructions supplied with the discs.

Playback Features (continued)

Operations for video playback (DVD/VCD/SVCD)

Using the Disc Menu

Depending on the disc, a menu may appear on the TV screen once you load in the disc.

To select a playback feature or item

- Use ▲ ▼ ◀ ▶ keys or alphanumeric keypad (0-9) on the remote, then press **OK** to start playback.

To access or remove the menu

- Press **DISC MENU** on the remote.

Zooming in

This function allows you to enlarge the picture on the TV screen and to pan through the enlarged picture.

- 1 During playback, press **ZOOM** repeatedly to display the picture with different scales.
 - Use ▲ ▼ ◀ ▶ keys to pan through the enlarged picture.
 - Playback will continue.
- 2 Press **ZOOM** repeatedly to return to the original size.

Resuming playback from the last stopped point

Resume playback of the last 10 discs is possible, even if the disc was ejected or the power switched off.

- Load one of the last 10 discs.
 - 'LOADING' appears.
- During loading mode press **PLAY ▶** and the disc will be played back from the last point.

To cancel resume mode

- In stop mode, press **STOP ■** again.

Slow Motion

- 1 Press ▲ ▼ during playback to select the required speed: 1/2, 1/4, 1/8 or 1/16 (forward or backward).
 - Sound will be muted.
- 2 To return to normal speed, press **PLAY ▶**.

Forward / Reverse Searching

You can fast forward or fast reverse a disc during playback and select a desired search speed.

- 1 Press ◀◀ / ▶▶ during playback to select the required speed: 2X, 4X, 8X, 16X or 32X (backward or forward).
 - Sound will be muted (DVD/VCD) or intermittent (CD).
- 2 To return to normal speed, press **PLAY ▶**.

TIPS: The operating features described here might not be possible for certain discs. Always refer to the instructions supplied with the discs.

Playback Features (continued)

Selecting various repeat/shuffle functions

Repeat play mode

The repeat play options vary depending on the disc type.

- 1 While playing a disc, press **REPEAT** continuously to choose a repeat options.

For DVD

- Chapter (currently playing chapter)
- Title (currently playing title)
- Disc (entire disc)
- Repeat Off (cancel)

For Video CD, Audio CD

- Track (currently playing track)
- Disc (entire disc)
- Off (cancel)

For MP3, WMA, SACD

- Track (currently playing track)
- Disc (entire disc)
- Off (cancel)

For JPEG, DivX

- Track (currently playing track)
- Disc (entire disc)
- Off (cancel)

Tip:

- For VCD, repeat playback is not possible if the PBC mode is switched on.

Repeating a section within a chapter/track

You can repeat the playback of a specific segment within a title/chapter track. To do this, you must mark the start and end of the segment you want.

- 1 While playing a disc, press **REPEAT A-B** at your chosen starting point.
- 2 Press **REPEAT A-B** again at your chosen end point.
 - The section A and B can be set only within the same chapter/track.
 - The section will now repeat continuously.
- 3 To exit the sequence, press **REPEAT A-B**.

Shuffle

For DVD disc, this shuffles the playing order of chapters within a title, if the title has more than one chapter.

For Audio CD, VCD, SACD, this shuffles all the tracks in random order within a disc.

- 1 Press **SHUFFLE** during playback.
 - The following shuffle modes appears on the display.
 - Shuffle (currently playing chapter/tracks)
 - Shuffle Repeat (entire disc)
 - Shuffle Off (cancel)
- 2 To exit the shuffle mode, press **STOP** ■.

TIPS: The operating features described here might not be possible for certain discs. Always refer to the instructions supplied with the discs.

Playback Features (continued)

Viewing the disc playback information

You can view the disc information (e.g., current title/chapter/track number, total playing time or remaining time on the disc) without interrupting the disc playback.

- 1 During playback, press **DISPLAY** repeatedly on the remote control.
→ The available disc information appears on the TV screen with the following sequence.

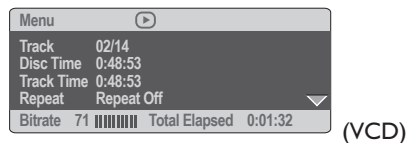

Title/Chapter/Track selection

- 1 Press **▲ ▼** to select {Title} / {Chapter} or {Track}, then press **OK** to access.
- 2 Use the **alphanumeric keypad 0-9** to input a valid number.
- 3 Press **OK** to confirm.
→ The playback skips to the chosen title/chapter/track.

Time Search

- 1 Press **▲ ▼** to highlight {Time Disp.}, then press **OK** to access.
→ The following display types appears on the TV, depending on the disc in the player.

For DVD discs;

TT Elapsed – elapsed playing time of current Title.
TT Remain – remaining playing time of current Title.
CH Elapsed – elapsed playing time of current Chapter.
CH Remain – remaining playing time of current Chapter.

For VCD/SVCD disc;

Total Elapsed – elapsed playing time of current disc.
Total Remain – remaining playing time of current disc.
Single Elapsed – elapsed playing time of current track.
Single Remain – remaining playing time of current track.

- 2 Press **▲ ▼** to highlight {TT Time} / {CH Time} / {Disc Time} or {Track Time}, then press **▶** to access.
- 3 Use the **alphanumeric keypad 0-9** to input the valid time (e.g. 0:34:27).
- 4 Press **OK** to confirm.
→ The playback skips to the chosen time.

TIPS: The operating features described here might not be possible for certain discs. Always refer to the instructions supplied with the discs.

Playback Features (continued)

Preview function

The preview function allows you to reduce the picture of 6 tracks enough to display in a full screen.

- 1 Press **SCAN**.
→ The preview menu appears on the TV screen.

SELECT DIGEST TYPE:
TITLE DIGEST
CHAPTER DIGEST
TITLE INTERVAL
CHAPTER INTERVAL

(DVD)

SELECT DIGEST TYPE:
TRACK DIGEST
DISC INTERVAL
TRACK INTERVAL

(VCD)

- 2 Press **▲ ▼** to select preview type, then press **OK**.
→ The picture of each segment will appear on the TV screen.



- 3 Press **▲ ▼ ◀ ▶** to select a track and input the selected track number using the alphanumeric keypad (0-9), then press **OK**.
→ Playback starts automatically on the selected track.
- For CDDA (Musical CD).
→ Press **SCAN** to listen to the first few seconds of each sound track in the disc.

Special DVD Features

Playing a Title

- 1 Press **DISC MENU**.
→ The disc title menu appears on the TV screen.
- 2 Use **▲ ▼ ◀ ▶** keys or **alphanumeric keypad 0-9** to select a play option.
- 3 Press **OK** key to confirm.

Changing the Audio Language

For DVD

- Press **AUDIO** repeatedly to select different audio languages.

Changing the Audio Channel For VCD

- Press **AUDIO** to select the available audio channels provided by the disc (MONO LEFT, MONO RIGHT, MIX-MONO, STEREO).

Subtitles

- Press **SUBTITLE** repeatedly to select different subtitle languages.

TIPS: The operating features described here might not be possible for certain discs. Always refer to the instructions supplied with the discs.

Playback Features (continued)

Special VCD and SVCD Feature

Playback Control (PBC)

For VCD with Playback Control (PBC) feature (version 2.0 only)

- Press **DISC MENU** to toggle between 'PBC ON' and 'PBC OFF'.
 - If you select 'PBC ON', the disc menu (if available) will appear on the TV.
 - Use the **◀◀ / ▶▶** or the **alphanumeric keypad 0-9** to select a play option.
- During playback, pressing **RETURN** will return to the menu screen (if PBC is on).
If you want to skip the index menu and playback directly from the beginning,
- Press **DISC MENU** key on the remote control to switch to PBC off.

Playing a Super Audio CD (SACD)

There are three types of SACD discs; single layer, double layer or hybrid disc. The hybrid disc contains both Super Audio CD and standard audio CD layers.

- ① Load a SACD.
 - The disc menu appears on the TV screen.
 - ② Playback will start automatically.
- If the SACD consists of both multi-channel and stereo tracks, the multi-channel tracks will have the priority for playback.
 - To playback stereo tracks, use **▲▼** to make your selection from the disc menu, then press **PLAY ▶**.

Tips:

- Press **SOUND MODE** on the remote control to switch between; *Jazz, Rock, Digital, Classic (for CDDA, MP3, SACD) and Action, Concert, Drama (for DVD, VCD, SACD)*
- Program SACD tracks is not possible.

TIPS: The operating features described here might not be possible for certain discs. Always refer to the instructions supplied with the discs.

Playback Features (continued)

Playing a DivX disc

This DVD player supports the DivX movie playback that you download from your computer onto a CD-R/RW or DVD±R/RW (see page 35 for more information).

- 1 Load a DivX disc.
→ Playback will start automatically. If not press **PLAY** ►.
- 2 Press **SUBTITLE** on the remote control will turn on or off the subtitle.
- If multilingual subtitles are embedded on the DivX disc, pressing **SUBTITLE** will change the subtitle language during playback.

Tips:

- Subtitle files with the following filename extensions (.srt, .smi, .sub, .ssa, .ass) are supported but do not appear on the file navigation menu.
- The subtitle filename have to be the same as the filename of the movie.

Advance features of the DivX Ultra

- XSUB™ subtitles lets you author movies with multiples language subtitle sets.
- Interactive video menus offer unprecedented convenience and control so you can quickly navigate between various scenes or bonus features and select from audio track and subtitle options.
- Alternate audio tracks enable audio tracks in multiple language versions or separate audio tracks for specific speaker configurations.
- Chapter points provide flexibility, allowing you to jump straight to the scene you want to watch from anywhere within the video.

TIPS: The operating features described here might not be possible for certain discs. Always refer to the instructions supplied with the discs.

Playback Features (continued)

Playing MP3/WMA/JPEG/ Kodak Picture CD

IMPORTANT!

You have to turn on your TV and set to the correct Video In channel. (See page 19 'Finding your viewing channel').

- For Kodak disc, the slide show will begin.
- For JPEG disc, the picture menu appears on the TV screen.
Press **PLAY** ► to start the slide show playback.

General Operation

- 1 Load a disc.
 - The disc reading time may exceed 30 seconds due to the complexity of the directory/file configuration.
 - The data disc menu appears on the TV screen.

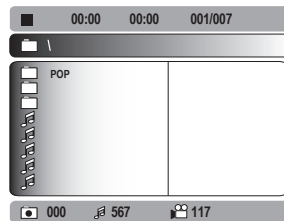

- 2 Press **▲ ▼** to select the folder and press **OK** to open the folder.
- 3 Press **▲ ▼** to select a track/file.
- 4 Press **OK** to confirm.

Playback selection

During playback, you can;

- Press **◀◀ / ▶▶** to select the previous or next track/file in the current folder.
- Press **▲ ▼ ◀ ▶** on the remote to rotate or flip the picture files.
- Press **PAUSE II** or **PLAY ►** repeatedly to pause or resume playback.

For MP3,

- During playback, press and hold **◀◀ / ▶▶** for about few seconds to access fast forward or fast reverse.
- Press and hold **◀◀ / ▶▶** to select the required speed: 2X, 4X, 8X, 16X or 32X.

Preview (JPEG)

This function shows the content of the current folder or the whole disc.

- 1 Press **STOP** during playback.
 - 12 thumbnail pictures appears on the TV screen.



- 2 Press **◀◀ / ▶▶** to display the other pictures on the previous or next page.
- 3 Use **▲ ▼ ◀ ▶** to highlight one of the picture and press **OK** to start playback.
- 4 Press **DISC MENU** to return to picture CD menu.

TIPS: The operating features described here might not be possible for certain discs. Always refer to the instructions supplied with the discs.

Playback Features (continued)

Zoom picture (JPEG)

- During playback, press **ZOOM** repeatedly to display the picture with different scales.
- Use ▲ ▼ ◀ ▶ to view the zoomed picture.

Playback with multi-angles (JPEG)

- During playback, press ▲ ▼ ◀ ▶ to rotate the picture on the TV screen.
 - ▲: flip the picture vertically by 180°
 - ▼: flip the picture horizontally by 180°
 - ◀: rotate the picture anti-clockwise by 90°
 - ▶: rotate the picture clockwise by 90°

Tips:

- It may not be possible to play certain MP3/JPEG disc due to the configuration and characteristics of the disc or condition of the recording.
- It is normal to experience an occasional “skip” while listening to your MP3 disc.
- For multi-session discs with different formats, only the first session will be available.

Scan effect

- Press **ANGLE** repeatedly to choose different scan effect.
 - Various scan effect appears on the top left hand corner on the TV screen.

Playing MP3/WMA music and JPEG picture simultaneously

- 1 Load a disc that contains music and picture.
 - The disc menu appears on the TV screen.
- 2 Select an MP3/WMA track.
- 3 During MP3/WMA music playback, select a picture and press **PLAY ▶**.
 - The picture files will be played back one after another until end of the folder.
- 4 To quit simultaneous playback, press **STOP ■**.

Tip:

- Some files on Kodak or JPEG disc may be distorted during playback due to the configuration and characteristics of the disc.

TIPS: The operating features described here might not be possible for certain discs. Always refer to the instructions supplied with the discs.

DVD Menu Options

You can make various adjustments to items such as picture and sound using the DVD setup menu.

Using the General setup menu

- 1 Press **SYSTEM MENU** on the remote control.
→ The system setup menu appears.

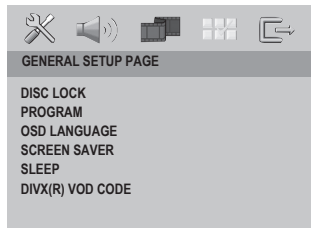

- 2 Press **◀ ▶** to select { **General Setup Page** }, then press **OK**.
- 3 Press **▲ ▼** to select an item, then press **▶** to access.
Example: { **OSD Language** }
→ The options for the selected item appears.
→ If the selection in the menu is greyed out, that means the feature is not available or not possible to change at the current state.
- 4 Use **▲ ▼** to select a setting and press **OK** to confirm.
Example: { **English** }
→ The setting is selected and setup is complete.
- 5 To exit, press **SYSTEM MENU**.

Locking/Unlocking the disc for viewing

You can set the playback restrictions so that the system will not play inappropriate disc. Up to 40 discs can be locked.

- 1 In 'General Setup Page', use **▲ ▼** keys to highlight { **Disc Lock** }, then press **▶**.
{ **Lock** }
Select this to block the playback of the current disc. A six-digit pin code must be entered in order to play the locked disc. The default password is '000 000' (see page 44 'Changing the password').
{ **Unlock** }
All discs can be played.
- 2 Use **▲ ▼** keys to select a setting and press **OK** to confirm.

TIPS: The underlined option is the factory default setting.
Press **◀** to go back to previous menu item. Press **SYSTEM MENU** to exit the menu item.

DVD Menu Options (continued)

Program play (not for Picture CD/MP3/WMA/DivX/SACD)

Program allows you to play the contents of a disc in the order you want by arranging the order of the tracks. You can store up to 20 tracks.

- In 'General Setup Page', use ▲ ▼ keys to highlight { **Program** }, then press ► to select { **Input Menu** }.
- Press **OK** to confirm.

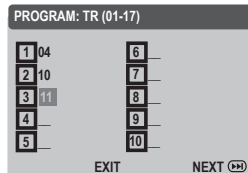

To program your favorite track/ chapter

- Use the alphanumeric keypad 0-9 to enter the valid track/chapter number.
- Use ◀ ▶ ▲ ▼ keys to move the cursor next position.
 - If the tracks/chapters are more than ten, press ▶▶ to display next page or use ◀ ▶ ▲ ▼ keys to select { **NEXT** } on the program menu, then press **OK**.
- Repeat steps 3 - 4 to enter other tracks/chapters.
- Use ▲ ▼ ◀ ▶ to select { **START** } on the program menu and playback starts.
 - Playback will start from the selected track/chapter according to the programmed sequence.

To remove track/chapter

- Use ▲ ▼ ◀ ▶ to select a track/chapter and press **OK**.

To exit program playback

- Use ▲ ▼ ◀ ▶ to select { **EXIT** } on the program menu and press **OK**.

OSD Language

This menu contains various language options for the language displayed on the screen. For details, see page 21.

Screen Saver – turning on/off

A screen saver prevents damage to the TV screen by avoiding exposure to a static image for long period of time.

- In 'General Setup Page', use ▲ ▼ keys to highlight { **Screen Saver** }, then press ►.

{ **On** }

Select this if you wish to turn off the TV screen when disc playback is stopped or paused for more than 15 minutes.

{ **Off** }

Select this to disable the screen saver function.

- Use ▲ ▼ keys to select a setting and press **OK** to confirm.

TIPS: The underlined option is the factory default setting.
Press ◀ to go back to previous menu item. Press **SYSTEM MENU** to exit the menu item.

DVD Menu Options (continued)

Sleep

Sleep function allows you to turn off the DVD player automatically if no actions are performed after a preset time.

- 1 In 'General Setup Page', use ▲ ▼ keys to highlight { **Sleep** }, then press ►.

{ 15 mins }

Select this if you wish to turn off the DVD player after 15 minutes.

{ 30 mins }

Select this if you wish to turn off the DVD player after 30 minutes.

{ 45 mins }

Select this if you wish to turn off the DVD player after 45 minutes.

{ 60 mins }

Select this if you wish to turn off the DVD player after 60 minutes.

{ Off }

Select this to disable the sleep function.

- 2 Use ▲ ▼ keys to select a setting and press **OK** to confirm.

DivX Registration Code

DivX® VOD (Video On Demand) registration code allows you to rent and purchase movies using the DivX® VOD service from the internet.

For more information, visit website:
<http://vod.divx.com>

- 1 In 'General Setup Page', use ▲ ▼ keys to highlight { **DivX(R) VOD Code** }, then press ►.

→ The registration code will appear.

- 2 Press **OK** to exit.

- 3 Use the registration code to rent or purchase the movies from DivX® VOD service at <http://vod.divx.com>.

→ Follow the instructions and download the movie from your computer onto a CD-R/RW for playback on this DVD player.

Tip:

– All the downloaded movies from DivX® VOD can only be played back on this DVD player.

TIPS: The underlined option is the factory default setting.
Press ◀ to go back to previous menu item. Press **SYSTEM MENU** to exit the menu item.

DVD Menu Options (continued)

Using the Audio setup menu

- 1 Press **SYSTEM MENU** on the remote control.
→ The system setup menu appears.

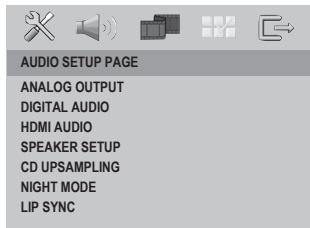

- 2 Press **◀ ▶** to select { **Audio Setup Page** }, then press **OK**.
- 3 Press **▲ ▼** to select an item, then press **▶** to access.
Example: { **Night Mode** }
→ The options for the selected item appears.
→ If the selection in the menu is greyed out, that means the feature is not available or not possible to change at the current state.
- 4 Use **▲ ▼** to select a setting and press **OK** to confirm.
Example: { **On** }
→ The setting is selected and setup is complete.
- 5 To exit, press **SYSTEM MENU**.

Analog Output

This audio mode outputs the sound from the front left and right speakers and subwoofer. It downmixed all sound surround format to standard two channel (stereo).

- 1 In 'Audio Setup Page', use **▲ ▼** keys to highlight { **Analog Output** }, then press **▶**.

{ **Stereo** }

Select this when output delivers sound from only the two front speakers.

{ **Multi-channel** }

Select this to enable multi-channel output. Dolby Pro Logic II will be activated if a 2 channel recorded disc is being played back.

- 2 Use **▲ ▼** keys to select a setting and press **OK** to confirm.

Tip:

– *Multi-channel and downmixed stereo output are not available simultaneously.*

TIPS: The underlined option is the factory default setting.
Press **◀** to go back to previous menu item. Press **SYSTEM MENU** to exit the menu item.

DVD Menu Options (continued)

Digital Audio Setup

This setting is only required when connecting DVD player's COAXIAL/OPTICAL OUT socket to other audio/video device. The options included in Digital Audio Setup are: { **Digital Output** } and { **LPCM Output** }.

- 1 In 'Audio Setup Page', use ▲ ▼ keys to highlight { **Digital Audio Setup** }, then press ►.
 - 2 Press ▲ ▼ keys to highlight an option.
 - 3 Enter its submenu by pressing ►.
 - 4 Press ▲ ▼ keys to select a setting and press **OK** to confirm.
- { **Digital Output** }
Select this if you connect to a multichannel decoder/receiver.
 - { All }
Select this if the connected device has a built-in multichannel decoder that supports one of the multichannel audio format (Dolby Digital, MPEG-2).
 - { **PCM** }
Select this if the connected device is not capable of decoding multichannel audio. The DVD player will convert the Dolby Digital and MPEG-2 multichannel signals to PCM (Pulse Code Modulation).
 - { **Off** }
To deactivate the digital audio output. For example, if you use the AUDIO OUT sockets to connect to a TV or stereo system.

- { **LPCM Output** }
Select this if you connect to a PCM compatible receiver. Discs are recorded at a certain sampling rate with the higher sampling rate, the better sound quality.
 - { **48kHz** }
Select this if the playback disc is recorded at a sampling rate of 48kHz.
 - { **96kHz** }
Select this if the playback disc is recorded at a sampling rate of 96kHz that can only be achieved in Stereo-Classic (Flat) mode.

HDMI Audio

This feature is available for automatic audio selection only when HDMI devices is connected and recognized.

- 1 In 'Audio Setup Page', use ▲ ▼ keys to highlight { **HDMI Audio** }, then press ►.
 - { **Off** }
Select this to turn off HDMI output.
 - { On }
Select this to turn on HDMI output.
- 2 Use ▲ ▼ keys to select a setting and press **OK** to confirm.

TIPS: The underlined option is the factory default setting. Press ◀ to go back to previous menu item. Press **SYSTEM MENU** to exit the menu item.

DVD Menu Options (continued)

Speaker Setup

This menu contains setup options for your audio output which makes the speaker setup system reproduce high quality surround sound. For details, see page 22.

CD Upsampling

You can convert your music CD to a higher sampling rate using complicated digital signal for better sound quality. If CD upsampling is activated, the DVD player will automatically switch to stereo mode.

- 1 In 'Audio Setup Page', use ▲ ▼ keys to highlight { **CD Upsampling** }, then press ►.

{ Off }

Select this to disable the CD Upsampling function.

{ **88.2 kHz (x2)** }

Select this to convert the CD sampling rate twice higher than the original.

{ **176.4 kHz (x4)** }

Select this to convert the CD sampling rate four times higher than the original.

- 2 Use ▲ ▼ keys to select a setting and press **OK** to confirm.

Tip:

– CD Upsampling feature is only applicable in stereo output setting.

Night Mode

This mode optimises playback of sound at low volume. High volume outputs will be softened and low volume outputs are brought upward to an audible level.

- 1 In 'Audio Setup Page', use ▲ ▼ keys to highlight { **Night Mode** }, then press ►.

{ **On** }

Select this to set low volume output. This feature is only available for movie discs with Dolby Digital mode.

{ Off }

Turns off night mode feature. Select this to enjoy the surround sound with its full dynamic range.

- 2 Use ▲ ▼ to select a setting and press **OK** to confirm.

Lip Sync

This allows you to adjust the audio delay (ms) with respect to the video output for the lip synchronization.

- 1 In 'Audio Setup Page', use ▲ ▼ keys to highlight { **Lip Sync** }, then press ►.

→ Use ◀▶ to adjust the following options; { **0ms** } → { **200ms** }

- 2 Press **OK** to confirm.

TIPS: The underlined option is the factory default setting.
Press ◀ to go back to previous menu item. Press **SYSTEM MENU** to exit the menu item.

DVD Menu Options (continued)

Using the Video setup menu

- 1 Press **SYSTEM MENU** on the remote control.
→ The system setup menu appears.

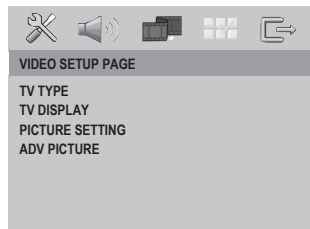

- 2 Press **▲ ▼** to select { **Video Setup Page** }, then press **OK**.
- 3 Press **▲ ▼** to select an item, then press **▶** to access.
Example: { **TV Type** }
→ The options for the selected item appears.
→ If the selection in the menu is greyed out, that means the feature is not available or not possible to change at the current state.
- 4 Use **▲ ▼** to select a setting and press **OK** to confirm.
Example: { **Multi** }
→ The setting is selected and setup is complete.
- 5 To exit, press **SYSTEM MENU**.

TV Type

This menu contains the options for selecting the color system that matches the connected TV. For details, see page 20.

Setting the TV Display

The picture shape can be adjusted to fit your TV and the format must be available on the playback disc. Otherwise, the TV display will not affect the picture during playback.

- 1 In 'Video Setup Page', use **▲ ▼** keys to highlight { **TV Display** }, then press **▶**.
{ **4:3 Panscan** }
Select this for a full-height picture with the sides trimmed.
{ **4:3 Letterbox** }
Select this for a 'wide-screen' display with black bars on the top and bottom.
{ **16:9** }
Select this for wide-screen TV (frame ratio 16:9).
- 2 Use **▲ ▼** keys to select a setting and press **OK** to confirm.

TIPS: The underlined option is the factory default setting.
Press **◀** to go back to previous menu item. Press **SYSTEM MENU** to exit the menu item.

DVD Menu Options (continued)

Picture Setting

You can define one personal setting or select from three sets of predefined TV picture color setting in this DVD player.

- In 'Video Setup Page', use ▲ ▼ keys to highlight { **Picture Setting** }, then press ►.

{ **Standard** }

Select this for a preset standard picture setting.

{ **Vivid** }

Select this to make the picture brighter.

{ **Cool** }

Select this to make the picture softer.

{ **Personal** }

Select this to personalise your picture color by adjusting the brightness, contrast, tint and color (saturation).

- Use ▲ ▼ to select a setting and press **OK** to confirm.
- If you select {PERSONAL}, then proceed to steps ④~⑦.
→ The setup menu appears.

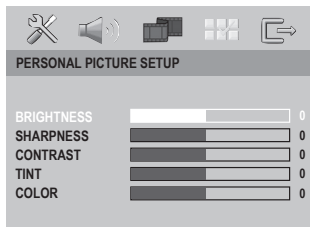

- Press ▲ ▼ to highlight one of the following options.

BRIGHTNESS

Increase the value to brighten the picture or vice versa. Choose zero (0) for average setting.

SHARPNESS

Increase the value to sharpen the picture or vice versa. Choose zero (0) for average setting.

CONTRAST

Increase the value to sharpen the picture or vice versa. Choose zero (0) to balance the contrast.

TINT

Increase the value to darken the picture or vice versa. Choose zero (0) for average setting.

COLOR

Increase the value to enhance the color in your picture or vice versa. Choose zero (0) to balance the color.

- Press ◀ ▶ to adjust the setting that best suits your personal preference.
- Repeat steps ④~⑤ for adjusting other color features.
- Press **OK** to confirm.

TIPS: The underlined option is the factory default setting.
Press ◀ to go back to previous menu item. Press **SYSTEM MENU** to exit the menu item.

DVD Menu Options (continued)

Advance Picture

This setting allows you to fine-tune the following video parameters.

- 1 In 'Video Setup Page', use ▲ ▼ keys to highlight { **Advance Picture** }, then press ►.
- 2 Press ▲ ▼ keys to highlight an option.
- 3 Enter its submenu by pressing ►.
- 4 Press ▲ ▼ keys to select a setting and press **OK** to confirm.

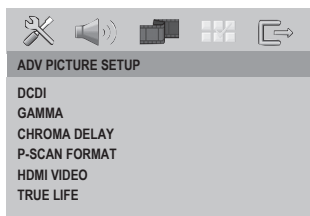

- { **Chroma Delay** } (for Component video output only)
The chroma (color) and luma (brightness) signals are not synchronized. This setting allows you to adjust the advance delay of the chroma signal to yield a perfectly clear picture.
– { -3 } → { 0 } → { +3 }
- { **PSCAN Format** } (for Progressive Scan output only)
Select this to adjust the ratio of the pictures on the TV screen.
– { **Superwide** }
Select this for display of 4:3 image on 16:9 TV with non-linear stretching (center portion of screen is stretch less than the side).
– { **4:3 Pillar Box** }
Select this for display of 4:3 image on 16:9 TV without stretching (a black pillar will be applied to both left and right side)
– { **Off** }
No aspect ratio adjustment is made when this option is selected.
- { **DCDi** } (for Progressive Scan output only)
DCDi (Directional Correction Deinterlacing) computes and tracks the angle of edge to fill in the missing pixels on the TV screen.
– { **On** }
Optimize the picture quality significantly, especially during the slow motion playback.
– { **Off** }
Select this to disable DCDi function.
- { **Gamma** } (for Component video output only)
Enables you to adjust the intensity of the picture non-linearly. A positive value enables you to bring out low level detail in dark scenes, while a negative value emphasizes contrast.
– { -7 } → { 0 } → { +7 }

TIPS: The underlined option is the factory default setting.
Press ◀ to go back to previous menu item. Press **SYSTEM MENU** to exit the menu item.

DVD Menu Options (continued)

- { **HDMI Video** } (for HDMI/DVI output only)

Select this to adjust the resolution for finer color selection when picture appears on the TV screen.

- Use ◀▶ to select the following options;
{ **480p**, **576p**, **720p**, **1080i**, **Auto** }

Tips:

- If no display appears on the TV screen due to unsupported resolution, reconnect any available interlace video output to your monitor to re-adjust the resolution setting.
- Only 480p and 576p are available for progressive scan analog output.

- { **True Life** } (for Progressive Scan output only)

Produces a more dynamic picture by increasing the contrast and color intensity.

- Use ◀▶ to select the following options; { **00** } → { **05** }

Using the Preference setup menu

- 1 Press **SYSTEM MENU** on the remote control.

→ The system setup menu appears.

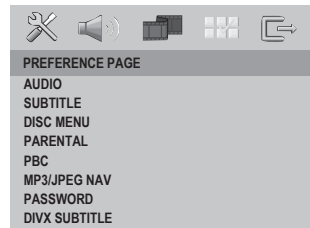

- 2 Press ▲ ▼ to select { **Preference Page** }, then press **OK**.

- 3 Press ▲ ▼ to select an item, then press ▶ to access.

Example: { **Parental** }

→ The options for the selected item appears.

→ If the selection in the menu is greyed out, that means the feature is not available or not possible to change at the current state.

- 4 Use ▲ ▼ to select a setting and press **OK** to confirm.

Example: { **8 Adult** }

→ The setting is selected and setup is complete.

- 5 To exit, press **SYSTEM MENU**.

TIPS: The underlined option is the factory default setting.
Press ◀ to go back to previous menu item. Press **SYSTEM MENU** to exit the menu item.

DVD Menu Options (continued)

Audio, Subtitle, Disc Menu settings

These menus contain various language options for audio, subtitle and disc menu which may be recorded on the DVD. For details, see page 21.

Parental

Depending on the DVD, you may be asked to change the parental level while playing the disc. The rating levels are from 1 to 8 and are country dependent. You can prohibit the playing of certain discs that are not suitable for your children, or have certain discs played with alternative scenes.

- 1 In 'Preference Page', use ▲ ▼ keys to highlight { **Parental** }, then press ►.

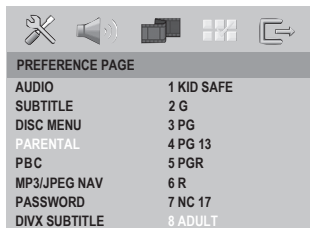

- 2 Use ▲ ▼ keys to select a rating level for the disc inserted and press **OK** to confirm.
→ Select { **8 Adult** } to disable parental level and allow all discs to play.
- 3 Use the **alphanumeric keypad 0-9** to enter the six-digit password. (see page 44 {Changing the Password})
- DVDs that are rated higher than the level you selected will not play unless you enter your six-digit password.

{ 1. Kid Safe }

Childsafe; acceptable for viewers of all ages.

{ 2. G }

General Audience; recommended as acceptable for viewers of all ages.

{ 3. PG }

Parental Guidance suggested.

{ 4. PG 13 }

Unsuitable for children under age 13.

{ 5. PG R }

Parental Guidance; recommended that parents restrict children under 17 from viewing.

{ 6. R }

Restricted; recommended only when supervised by a parent or adult guardian.

{ 7. NC 17 }

No Children under age 17; not recommended viewing for children under age 17.

{ 8. Adult }

Mature Material; should be viewed only by adults due to graphic sexual material, violence or language.

Tips:

- This feature will not limit viewing if the disc manufacturer did not code the disc.
- VCD, SVCD, CD have no level indication, so parental control has no effect on these type of discs. This also applies to most illegal DVDs.
- Some DVDs are not coded with a rating though the movie rating may be printed on the disc cover. The rating level feature does not prohibit play of such discs.

TIPS: The underlined option is the factory default setting.
Press ◀ to go back to previous menu item. Press **SYSTEM MENU** to exit the menu item.

DVD Menu Options (continued)

PBC (Playback Control)

You can set the PBC (Playback Control) to { On } or { Off }. This feature is available only when a Video CD 2.0 recorded with playback control feature. For details, see page 29.

MP3/JPEG Menu – turning on/off

MP3/JPEG Menu can be set only if the disc is recorded with menu. It allows you to select different display menus for easy navigation.

- In 'Preference Page', use ▲ ▼ keys to highlight { **MP3/JPEG Nav** }, then press ►.

{ Without Menu }

Select this to display all the files contained in the MP3 or Picture CD.

{ With Menu }

Select this to display only the folder menu of the MP3 or Picture CD.

- Use ▲ ▼ keys to select a setting and press **OK** to confirm.

Changing the Password

You need to enter your six-digit password to play a prohibited disc or if prompted for a password.

- In 'Preference Page', use ▲ ▼ keys to highlight { **Password** }, then press ► to select { **Change** }.
→ You will be prompted to enter your six-digit password.

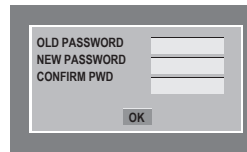

- Use the **alphanumeric keypad 0-9** to enter the old six-digit password.
→ When doing this for the first time, enter the default password '000 000'.
- If you forget your old six-digit password, enter the default password '000 000'.
- Enter the new six-digit password, then enter the same password **a second** time in the next entry field.
→ The new six-digit password will now take effect.
- Press **OK** to confirm.

TIPS: The underlined option is the factory default setting.
Press ◀ to go back to previous menu item. Press **SYSTEM MENU** to exit the menu item.

DVD Menu Options (continued)

Restoring to original settings

Setting the { **Default** } function will reset all options and your personal settings to the factory defaults, except your password for {Parental} and {Disc Lock}.

- 1 In 'Preference Page', use ▲ ▼ keys to highlight { **Default** }, then press ► to select { **Reset** }.
- 2 Press **OK** to confirm.
→ All settings will now reset to factory defaults.

Setting the DivX subtitle font

You can set the font type that supports the recorded DivX subtitle.

- 1 In 'Preference Page', use ▲ ▼ keys to highlight { **DivX Subtitle** }, then press ►.

{ Standard }

Albanian, Danish, Dutch, English, Finnish, French, Gaelic, German, Italian, Kurdish (Latin), Norwegian, Portuguese, Spanish, Swedish and Turkish.

{ **Chinese (Simp)** }

Chinese Simplified

- 2 Use ▲ ▼ keys to select a setting and press **OK** to confirm.

TIPS: The underlined option is the factory default setting.
Press ◀ to go back to previous menu item. Press **SYSTEM MENU** to exit the menu item.

Troubleshooting

WARNING

Under no circumstances should you try to repair the system yourself, as this will invalidate the warranty. Do not open the system as there is a risk of electric shock.

If a fault occurs, first check the points listed below before taking the system for repair. If you are unable to remedy a problem by following these hints, consult your dealer or Philips for help.

Problem	Solution
No power.	<ul style="list-style-type: none"> – Press STANDBY-ON button on the front of the DVD player to switch on the system. – Make sure the AC outlet has power.
Remote control does not work.	<ul style="list-style-type: none"> – Aim the remote control directly at the sensor on the front of the DVD player (not towards TV). – Remove any obstacles between DVD player and the remote control. – Batteries are weak, replace the batteries. – Check the polarities of the batteries are as indicated on the remote control (± signs). – Make sure the remote control is select at the relevant device [DVD] in order to control the DVD player.
No picture.	<ul style="list-style-type: none"> – Switch on your TV and set to the correct Video In channel for the DVD player. You may go to Channel 1 on your TV, then press the channel down button on your TV's remote control until you see the TV programme. – Check the video connection between the DVD player and the TV.
The picture is distorted or black & white during playback.	<ul style="list-style-type: none"> – The disc does not match with the TV colour system standard (PAL/NTSC). – The disc is dirty, clean the disc. – Sometimes a small amount of picture distortion may appear. This is not a malfunction.
No sound.	<ul style="list-style-type: none"> – Check the audio connections, the red and white jacks are connected correctly. – Set the Digital output correctly, based on the equipment you connected to the DVD player.
Disc does not play.	<ul style="list-style-type: none"> – Insert the disc with the label facing up. – Wrong region code. – Wrong disc type. Read chapter "Playback - Playable discs" for details. – Make sure the disc is not scratched or warped. Clean the disc or replace a new one. – Check if the disc is defective by trying another disc.
The aspect ratio of the screen cannot be changed.	<ul style="list-style-type: none"> – The aspect ratio is fixed on the DVD disc. – Depending on the TV, it may not be possible to change the aspect ratio.

Need Help? Visit us at www.philips.com/support

Troubleshooting (continued)

Problem	Solution
Not able to select some items in the setup/system menu.	<ul style="list-style-type: none"> – Press STOP button twice before selecting the setup/system menu. – Depending on the disc availability, some menu items cannot be selected.
The DVD player does not start playback.	<ul style="list-style-type: none"> – Insert a readable disc with the playback side facing down. – Check the disc type, colour system (PAL/NTSC) and region code. – Check for any scratches or smudges on the disc. – Press SYSTEM MENU to turn off the setup menu screen. – You may need to enter the password in order to change the parental rating level or to unlock the disc for playback. – Moisture may have condensed inside the system. Remove the disc and leave the system turned on for about an hour. – Disconnect the power cord from the power outlet for a few minutes. Reconnect the power cord and try to operate again as usual.
Picture freezes momentarily during playback.	<ul style="list-style-type: none"> – Check the disc for fingerprint/scratches and clean with a soft cloth wiping from centre to edge.
Unable to select Progressive Scan on/off.	<ul style="list-style-type: none"> – Check that the output of the video signal is switch to { YPbPr }.
Unable to play DivX movies.	<ul style="list-style-type: none"> – Check that the DivX file is encoded in 'Home Theatre' mode with DivX 5.x encoder. – Check that the DivX movie downloaded is a complete file.
No sound during DivX movies playback.	<ul style="list-style-type: none"> – The audio codec may not be supported by this DVD player.
An DivX movies does not repeat.	<ul style="list-style-type: none"> – Check that file size of the movie does not exceed the file size of the disc during downloading.
No sound is output from the HDMI out	<ul style="list-style-type: none"> – Check the connection between the TV and the HDMI jack of DVD player. – See if the TV supports this 480p/576p/720p/1080i DVD player. – Check your TV system setup correctly. – Make sure HDMI audio setting is set to {ON} in the System Menu.

Need Help? Visit us at www.philips.com/support

Specifications

TV STANDARD (PAL/50Hz) (NTSC/60Hz)

Number of lines	625	525
Playback	Multistandard (PAL/NTSC)	

VIDEO PERFORMANCE

Video DAC	12 bit, 216 MHz	
YPbPr	0.7 Vpp ~ 75 ohm	
Video Output	1Vpp ~ 75 ohm	
HDMI Output	480p, 576p, 720p, 1080i, Auto	

VIDEO FORMAT

Digital	MPEG 2 for DVD,SVCD	
Compression	MPEG 1 for VCD DivX	

DVD	50Hz	60Hz
Horiz. resolution	720 pixels	720 pixels
Vertical resolution	576 lines	480 lines

VCD	50Hz	60Hz
Horiz. resolution	352 pixels	352 pixels
Vertical resolution	288 lines	240 lines

AUDIO FORMAT

Digital	MPEG/ AC-3/ PCM	compressed Digital 16, 20, 24 bits fs, 44.1, 48, 96 kHz
	MP3(ISO 9660)	96, 112, 128, 256 kbps & variable bit rate fs, 32, 44.1, 48 kHz

Analog Sound Stereo
Dolby Surround compatible downmix from Dolby
Digital multi-channel sound

AUDIO PERFORMANCE

DA Converter	24 bit, 192 kHz	
DVD	fs 96 kHz	4Hz- 44kHz
	fs 48 kHz	4Hz- 22kHz
SVCD	fs 48 kHz	4Hz- 22kHz
	fs 44.1kHz	4Hz- 20kHz
CD/VCD	fs 44.1kHz	4Hz- 20kHz
Signal-Noise (1kHz)	> 122 dB (CD) > 124 dB (DVD)	
Dynamic range(1kHz)	96 dB (CD) 103 dB (DVD)	
Crosstalk (1kHz)	122 dB	
Distortion/noise (1kHz)	> 91 dB	
MPEG MP3	MPEG Audio L3	

CONNECTIONS

YPbPr Output	Cinch 3x
Video Output	Cinch (yellow)
S-Video Output	Mini DIN, 4 pins
Audio Output(L+R)	Cinch (white/red)
Digital Output	1 coaxial, 1 optical IEC60958 for CDDA / LPCM IEC61937 for MPEG 1/2, Dolby Digital and DTS
HDMI Output	Type A x 1
6 channel analog output	
Audio Front L/R	Cinch (white/red)
Audio Surround	Cinch (white/red)
Audio Center	Cinch (blue)
Audio Subwoofer	Cinch (black)

CABINET

Dimensions (w x h x d)	435 x 79 x 315 mm
Weight	Approximately 5.5 kg

POWER CONSUMPTION

Power Supply Rating	
U.S.A and Canada	120V, 60Hz
Australia/New Zealand	240V; 50Hz
U.K and Europe	230V; 50Hz
General models	110 - 240V; 50/60Hz
Power consumption	20 W
Power consumption in Standby mode	> 1 W

Glossary

Analog: Sound that has not been turned into numbers. Analog sound varies, while digital sound has specific numerical values. These jacks send audio through two channels, the left and right.

Aspect ratio: The ratio of vertical and horizontal sizes of a displayed image. The horizontal vs. vertical ratio of conventional TVs. is 4:3, and that of wide-screens is 16:9.

AUDIO OUT Jacks: Jacks on the back of the DVD System that send audio to another system (TV, Stereo, etc.).

Bit Rate: The amount of data used to hold a given length of music; measured in kilobits per seconds, or kbps. Or, the speed at which you record. Generally, the higher the bit rate, or the higher the recording speed, the better the sound quality. However, higher bit rates use more space on a Disc.

Chapter: Sections of a picture or a music piece on a DVD that are smaller than titles. A title is composed of several chapters. Each chapter is assigned a chapter number enabling you to locate the chapter you want.

Component Video Out Jacks: Jacks on the back of the DVD System that send high-quality video to a TV that has Component Video In jacks (R/G/B, Y/Pb/Pr, etc.).

Disc menu: A screen display prepared for allowing selection of images, sounds, subtitles, multi-angles, etc recorded on a DVD.

Digital: Sound that has been converted into numerical values. Digital sound is available when you use the DIGITAL AUDIO OUT COAXIAL or OPTICAL jacks. These jacks send audio through multiple channels, instead of just two channels as analog does.

DivX 3.11/4.x/5.x/6.x: The DivX codec is a patent-pending, MPEG-4 based video compression technology, developed by DivXNetworks, Inc., that can shrink digital video to sizes small enough to be transported over the internet, while maintaining high visual quality.

Dolby Digital: A surround sound system developed by Dolby Laboratories containing up to six channels of digital audio (front left and right, surround left and right, center and subwoofer).

JPEG: A very common digital still picture format. A still-picture data compression system proposed by the Joint Photographic Expert Group, which features small decrease in image quality in spite of its high compression ratio.

MP3: A file format with a sound data compression system. MP3 is the abbreviation of Motion Picture Experts Group I (or MPEG-I) Audio Layer 3. By using MP3 format, one CD-R or CD-RW can contain about 10 times as much data volume as a regular CD can.

Multichannel: DVD is specified to have each sound track constitute one sound field. Multichannel refers to a structure of sound tracks having three or more channels.

Parental Control: A function of the DVD to limit playback of the disc by the age of the users according to the limitation level in each country. The limitation varies from disc to disc; when it is activated, playback will be prohibited if the software's level is higher than the user-set level.

PCM (Pulse Code Modulation): A system for converting analog sound signal to digital signal for later processing, with no data compression used in conversion.

Playback control (PBC): Refers to the signal recorded on video CDs or SVCDs for controlling reproduction. By using menu screens recorded on a Video CD or SVCD that supports PBC, you can enjoy interactive-type software as well as software having a search function.

Progressive Scan: It displays all the horizontal lines of a picture at one time, as a signal frame. This system can convert the interlaced video from DVD into progressive format for connection to a progressive display. It dramatically increases the vertical resolution.

Region code: A system for allowing discs to be played back only in the region designated beforehand. This unit will only play discs that have compatible region codes. You can find the region code of your unit by looking on the product label. Some discs are compatible with more than one region (or ALL regions).

Title: The longest section of a picture or music feature on DVD, music, etc., in video software, or the entire album in audio software. Each title is assigned a title number enabling you to locate the title you want.

VIDEO OUT jack: Jack on the back of the DVD System that sends video to a TV.