

# 目錄

1 請注意	94
	94
2 產品說明	95
	95
	96
3 連接	99
	99
	100
	102
	102
	103
	103
	105
4 開始	106
	6
	107
	107
	108
	109
EasyLink	110
	111
5 播放	112
	112
	113
	116
	117
USB	119
	119
	120

6 調節聲音	122
	122
	122
	122
	123
(      )	123
	123
7 調整設定	124
	124
	125
	127
	129
8 其他資訊	132
	132
	132
	133
9 疑難排解	134
10 詞彙表	136

# 1 請注意

## 安全性與重要事項



- 5 10
- 
- 
- 
- 
- 



注意！

- 
- ) (
- 
- 
- 
- ) (

## 回收說明



## 版權說明



Macrovision Corporation  
Macrovision Corporation  
Corporatio Macrovision  
4,907,093 4,631,603 4,819,098  
5,315,448 6,516,132

## 2 產品說明

[www.philips.com/welcome](http://www.philips.com/welcome)

DVD  
DVD

### 功能特色

視訊升級至 1080p  
DVD (HDTV)  
DVD  
1080p

EasyLink  
EasyLink  
)  
HDMI CEC  
HDMI CEC (HDMI)

備註

- 100% HDMI CEC

收聽音質豐富、未經壓縮的的多聲道環繞  
音效

DVD 5.1

USB DIRECT 與 MP3 LINK

USB USB  
MP3/WMA/JPEG/DivX  
MP3

LINK

將音訊輸出與視訊播放同步  
DVD

區碼

DVD  
DVD

國家	DVD 區碼
	 
	 

中文(繁体)

# 產品概覽

## 遙控器

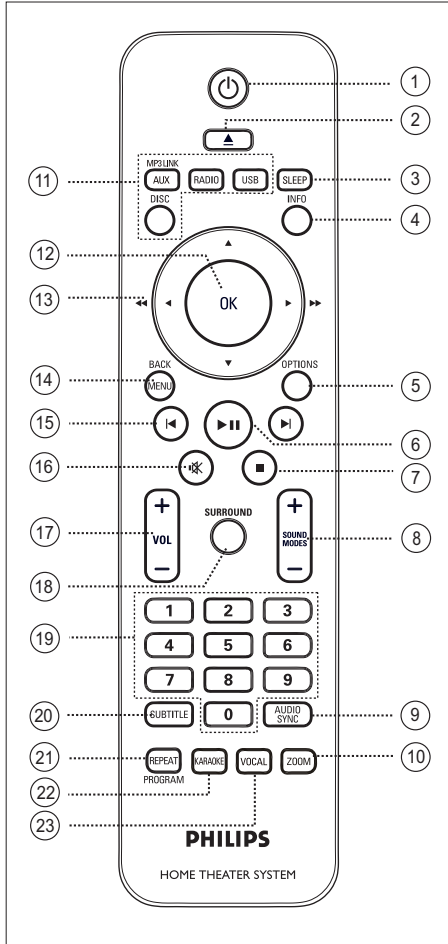

- ① 电源
- 
- ② ▲ ( / )
- 
- ③ SLEEP
- 
- ④ INFO
- 
- 12
- ⑤ OPTIONS
- OPTIONS ( )
- ⑥ ▶|| ( / )
- 
- RADIO: ( )
- ⑦ ■ ( )
- 
- RADIO:
- ⑧ SOUND MODES + -
- 
- ⑨ AUDIO SYNC
- /
- VOL + -
- ⑩ ZOOM
-

⑪ 音訊來源按鈕

- DISC: DISC
- USB: USB
- RADIO: FM
- AUX / MP3 LINK:
  - AUX1 AUX2 DI
  - (DIGITAL IN) MP3 LINK

⑫ OK

•

⑬ 游標按鈕 (▲▼◀▶)

•

•

• RADIO:

• RADIO:

⑭ MENU / BACK

•

• DVD

• VCD 2.0 PBC  
SVCD

⑮ ◀ / ▶ ( / )

•

/ /

• RADIO:

⑯ 咪 ( )

•

⑰ VOL + -

•

⑱ SURROUND

•

⑲

•

⑳ SUBTITLE

• DVD DivX

㉑ REPEAT / PROGRAM

•

• RADIO:

• RADIO:

㉒ KARAOKE

•

㉓ VOCAL

•

OK

# 主裝置

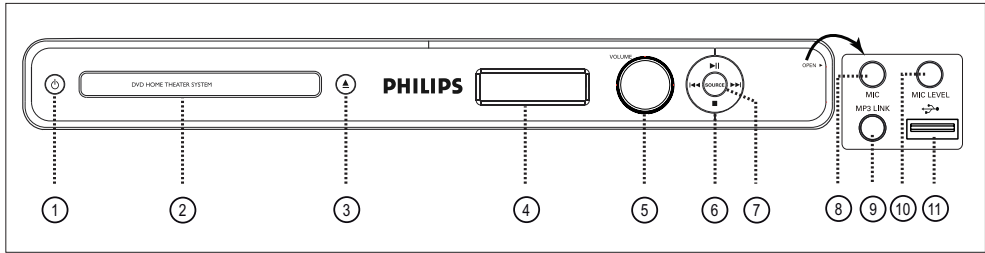

① 电源

②

③ ▲ ( / )

④ 顯示面版

⑤ VOLUME

⑥ ▶|| ( / )

• RADIO: ( )

■ ( )

• RADIO:

◀◀ / ▶▶

• / /

• /

• RADIO:

⑦ SOURCE

• DISC FM  
AUX1 AUX2 DI (DIGITAL IN)  
MP3 LINK

備註

• (OPEN ▶)

⑧ MIC

⑨ MP3 LINK

⑩ MIC LEVEL

⑪ USB

• USB USB

# 3 連接

DVD

## 基本線路連接:

- 
- 
- 
- HTS3569) (
- 
- 
- 

## 選擇性連接:

- 
- 
- / /
- 
- USB

### 備註

- 
- 

## 裝置的位置

- 
- AC AC
- AC

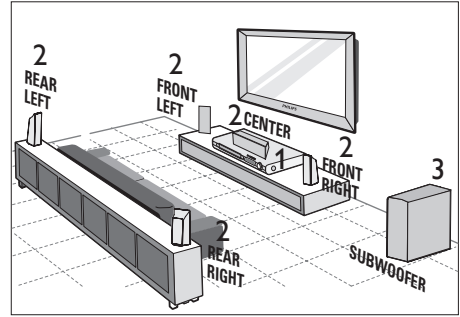

- HTS3569
- 1 DVD

- 2
- 

3

### 備註

- REAR LEFT REAR
- RIGHT
- FRONT LEFT
- FRONT RIGHT
- 

中文(繁体)

# 連接視訊線

DVD

- 選擇 1: HDMI ( )
- 選擇 2: DVI ( )
- 選擇 3: S-Video ( )
- 選擇 4: Video (CVBS) ( )

**備註**

- 

**備註**

- HDMI DVI-TV HDMI

**小秘訣**

- > [ 視訊設定 ] > [ HDMI 設定 ]
- HDMI CEC / HDMI EasyLink
- HDMI/DVI DVI
- DVD
- 

## 選擇 1：連接至 HDMI 插槽

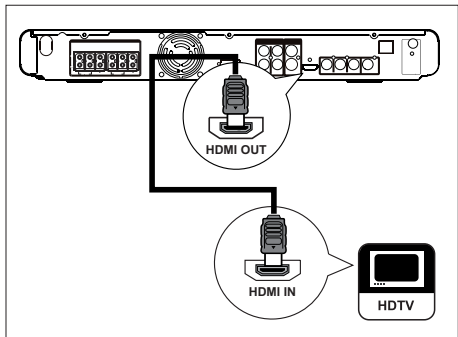

1 HDMI ( )  
HDMI OUT HDMI IN

## 選擇 2：連接至色差視訊插槽

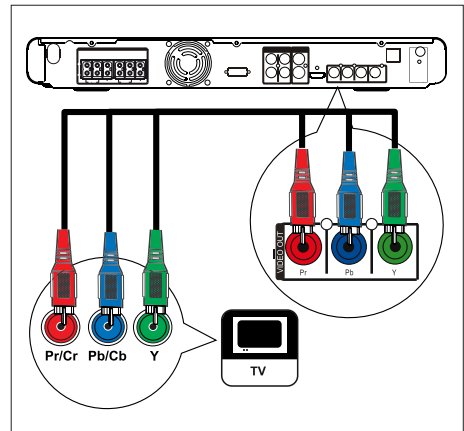



1 Y Pb Pr ( )

**\* 小秘訣**

- Pb/Cb Pr/Cr YUV Y
- 

選擇 3：連接至 S-Video 插槽

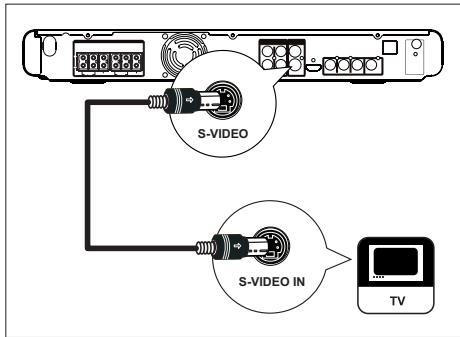

1 S-video ( )  
VIDEO OUT-S-VIDEO  
S-Video

**\* 小秘訣**

- Y/C S-VHS
- 

選擇 4：連接至 Video (CVBS) 插槽

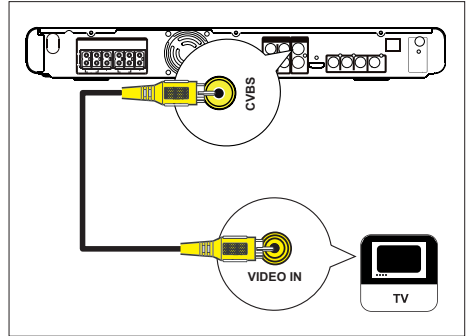

1 VIDEO OUT-CVBS ( )

**\* 小秘訣**

- A/V IN VIDEO IN COMPOSITE BASEBAND
- 

中文(繁体)

## 將揚聲器纜線連接至揚聲器

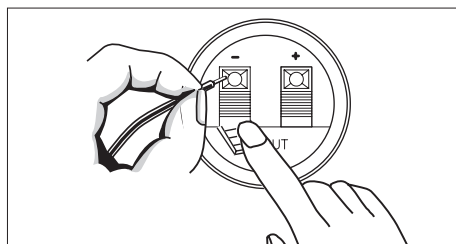

1

HTS3569



備註

•

## 連接揚聲器和重低音揚聲器

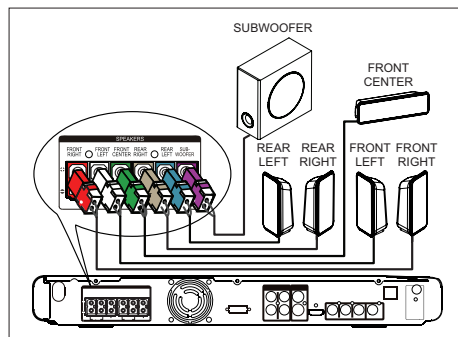

1

HTS3569



備註

•

## 連接收音機天線

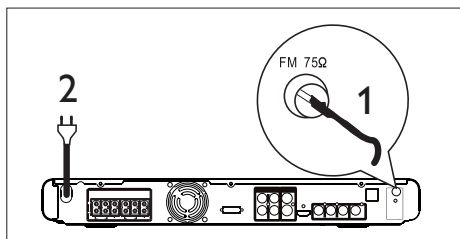

1 FM ( )  
FM75Ω ( )  
) FM

2 DVD

☰ 備註

• ) (

## 連接其他裝置

DVD

### 連接電視的音訊

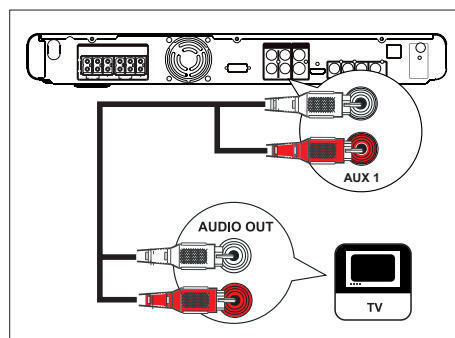

1 ( )  
AUDIO IN-AUX1  
AUDIO OUT

☰ 備註

• / MP3 LINK ' AUX 1' AUX

中文(繁体)

連接有線電視盒/錄影機/電玩主機的音訊

連接至類比插槽

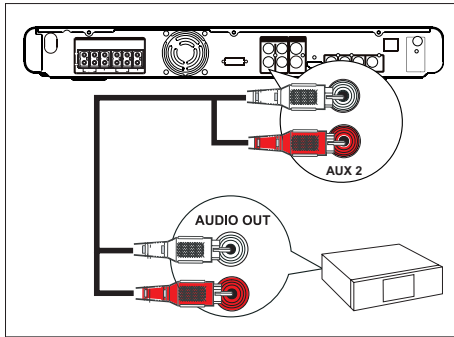

1 ( )  
AUDIO IN-AUX2  
AUDIO OUT

備註		AUX
• / MP3 LINK	· AUX2	

連接至數位插槽

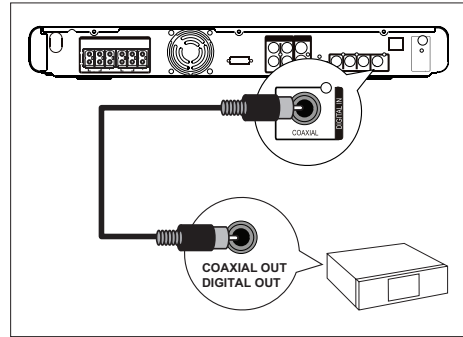

1 ( )  
DIGITAL IN-COAXIAL  
COAXIAL/DIGITAL OUT

備註		AUX
• / MP3 LINK	· DI	

連接可攜式媒體播放器

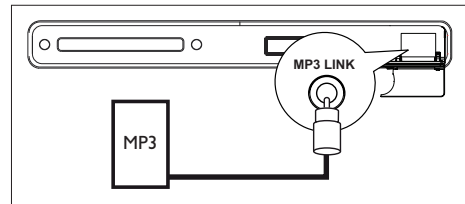

1 3.5mm ( )  
MP3 LINK  
( MP3 )

☰ 備註

- / MP3 LINK AUX ' MP3 LINK'

連接 USB 裝置

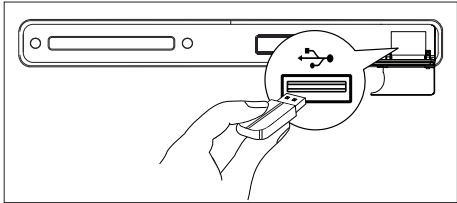

1 USB USB

☰ 備註

- DVD / MP3 WMA DivX (Ultra) JPEG
- USB

連接至電源插座

☰ 備註

- ) (

1 DVD

中文(繁体)

# 4 開始

## 準備遙控器

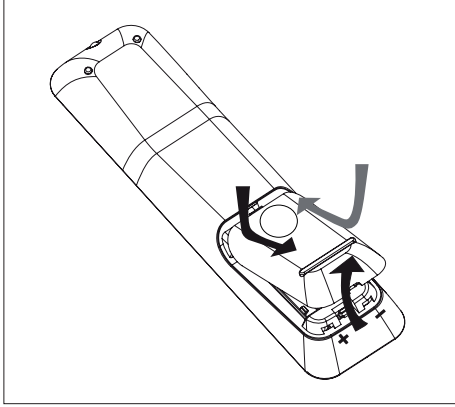

- 1
- 2 RO3 AAA (+ -)
- 3

備註

•

## 控制播放來源

- 1 DISC USB RADIO AUX / MP3 LINK
- 2

## 瀏覽選單

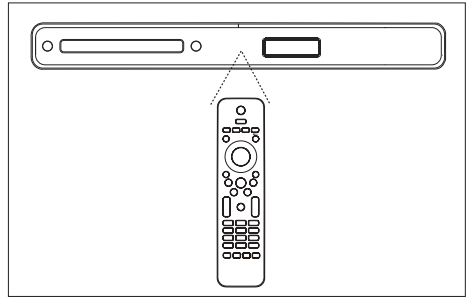
- 1 
- 2

按鈕	動作												
▲ ▼													
◀ ▶													
OK													
<table border="1" style="margin: 0 auto;"> <tr><td>1</td><td>2</td><td>3</td></tr> <tr><td>4</td><td>5</td><td>6</td></tr> <tr><td>7</td><td>8</td><td>9</td></tr> <tr><td colspan="3" style="text-align: center;">0</td></tr> </table>	1	2	3	4	5	6	7	8	9	0			
1	2	3											
4	5	6											
7	8	9											
0													

## 搜尋正確的觀賞頻道

- 1 DVD
  - 2 DISC
  - 3
- - Down Channel Video In
  - 
  - 
  - VIDEO FRONT A/V IN

小秘訣

- 

## 選擇選單的顯示語言

備註

- HDMI CEC

- 1 DISC
- 2 OPTIONS  
↳ [通用設定]
- 3 ▶
- 4 ▲▼ [畫面顯示語言] ▶

通用設定	
	碟片鎖定 自動
	顯示亮度 English
	畫面顯示語言 简体中文
	螢幕保護 繁體中文
	睡眠 Melayu
	DIVX(R) 隨選視訊 Русский
	ไทย

- 5 ▲▼  
OK

小秘訣





- DVD - [偏好設定]

中文(繁体)

# 開啟逐行掃描

1 ( )  
2 )

- 1
- 2 DISC
- 3 OPTIONS
- 4 ▼ [視訊設定]

視訊設定	
	電視類型 關
	電視顯示 開
	逐行掃描
	畫質設定
	HDMI 設定
	隱藏字幕

- 5 [逐行掃描] > [開]
- OK
- ↳
- 6 [確認]
- OK
- ↳

備註

• / 15

•

1) ▲

2) ▼

3) AUDIO SYNC

- 7 OPTIONS
- 8 ( )

備註

• DVD



# 變更揚聲器設定

- 1 DISC
- 2 OPTIONS
- 3 ▼ [音訊設定]

音訊設定	
	揚聲器音量
	揚聲器延遲
	HDMI音訊
	光碟升頻
	音訊同步
	

調整揚聲器的音量大小

- 4 [揚聲器音量]

揚聲器音量設定	
前置左	<input type="text"/> 0dB
前置右	<input type="text"/> 0dB
中置	<input type="text"/> 0dB
重低音	<input type="text"/> 0dB
後左側	<input type="text"/> 0dB
後右側	<input type="text"/> 0dB

- 5 OK

設定輸入延遲時間 (僅限中央及後置揚聲器)

- 6 [揚聲器延遲]

揚聲器距離設定	
中置	<input type="text"/> 0ms
後左側	<input type="text"/> 0ms
後右側	<input type="text"/> 0ms

- 7 OK

 小秘訣

•	
•	30cm
•	1ms

- 8 OPTIONS

中文(繁体)

## 啟動 EasyLink 控制

- 1 / HDMI CEC
  - CEC / HDMI
  - 2 EasyLink
- 
- 單鍵播放 [自動開機電視]  
PLAY  
( )
- 
- 單鍵關閉 [系統待機]  
HDMI CEC
- /
- ( )
- 〇
- 
- 單鍵音訊輸入切換 [系統音訊控制]
- 
- HDMI CEC TV/
- 

## 備註

- 
- 100% HDMI CEC

## 將音訊輸入對應到連接裝置

- 1 DISC
- 2 OPTIONS
- 3 ▼ [ 視訊設定 ]
- ▶
- 4 [ HDMI 設定 ] > [ EasyLink ]  
OK

EasyLink	
自動開機電視	
系統待機	
系統音訊控制	
HDMI 輸入對映	

- [ 自動開機電視 ]  
[ 系統待機 ]
  - 5 [ 系統音訊控制 ] > [ 開啟 ]  
OK
  - 6 [ HDMI 輸入對映 ]  
OK
  - 7 [ 確定 ] OK
- ↳

8 ( AUX1  
 AUX2) ▶  
 9 OK  
 . 8-9  
 10 OPTIONS

## 選取播放來源

在機體上

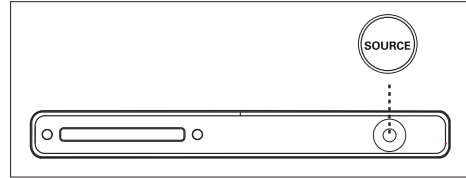

1 SOURCE : DISC >  
 FM > AUX1 > AUX2 > DI (DIGITAL  
 IN) > MP3 LINK > DISC ...

在遙控器上

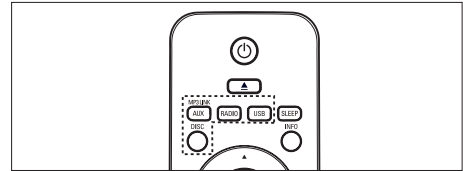

- DISC DISC ( )
- USB USB
- RADIO FM
- AUX / MP3 LINK

顯示	裝置連接至
AUX1	AUDIO IN-AUX1
AUX2	AUDIO IN-AUX2
DI	i DIGITAL IN-COAXIAL
MP3 LINK	MP3 LINK

中文(繁体)

# 5 播放

## 播放光碟

### 可播放光碟

	DVD • 3 ( ) • 4 ( )
	DVD± RW ( DVD)
	DVD± R ( DVD)
	DVD+R DL ( DVD+R)
	CD-RW ( CD) • MP3/WMA/JPEG/DivX
	CD-R ( CD) • MP3/WMA/JPEG/DivX
	(CD-DA )
	VCD • 1.0, 1.1, 2.0
	VCD

 備註

- DVD ( )

## 播放光碟

 警告!

- 
- 

1 ▲

2 .

3 ▲

• DVD

4 ■



 小秘訣

- 6
- 5
- DISC 15

## 播放視訊







 備註

•

Playback from the beginning, press  key (  )





## 控制標題

1  
2

按鈕	動作
	/
	
	/
	/ /
	/
	/
	•
	• VCD

## 變更視訊播放

1  
2

按鈕	動作
	•
	•
	/
	(RPT OFF)
	•
	• VCD
	PBC
	•
	•

## 存取 DVD 選單

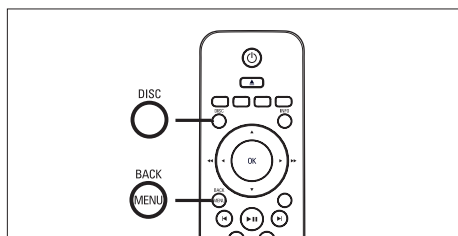

- 1 DISC
- 2 OK
- .
- .
- MENU

選擇摘要類型:

曲目摘要  
光碟間隔  
曲目間隔

[ 曲目摘要 ]

[ 光碟間隔 ]

[ 曲目間隔 ]

3 OK

## 存取 VCD 選單或預覽選單

VCD PBC ( )  
VCD

- 1
  - ▲▼
  - OK
  - PBC
  - 
  - (BACK) MENU ( PBC
  - )
- 2
  - DISC
  - DISC

 小秘訣

- PBC - [ 偏好設定 ] > [ PBC ]

## 將音訊輸出與視訊播放同步

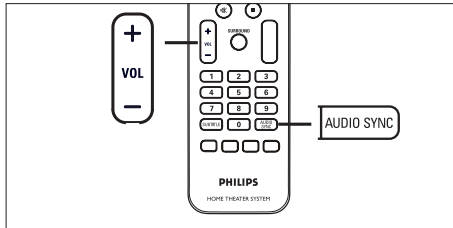

- 1           AUDIO SYNC  
    ' AUDIO SYNC XXX'  
    • XXX'
- 2           VOL + -



備註

- 5

## 快速跳過播放至特定時間

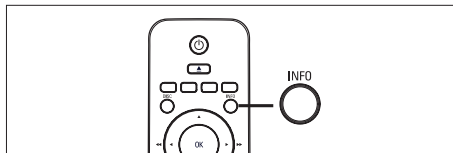

- 1           INFO  
    ↳
- 2           OK  
    • [ TT Time ] (        )  
    • [ CH Time ] (        )  
    • [ Disc Time ] (        )  
    • [ Track Time ] (        )

- 3           數字鍵  
            OK

## 重複播放特定片段

- 1           INFO  
    ↳
- 2           [ 重複 ]       ▶
- 3           [ ↻ A-B ]
- 4           OK
- 5           OK           [ 重播關  
            閉 ]       OK



備註

- /

## 從不同的攝影機角度觀賞 DVD 播放

- 1           INFO  
    ↳
- 2           OK           [ 角度 ]
- 3           OK           數字鍵



備註

-

## 播放 DivX® 视频

DivX

- DivX DivX®
- 1 DivX USB
- 2 DISC USB
- ↳
- 3 ▶||
- 4

按鈕	動作
	/
	• DivX Ultra
	DivX Ultra

備註

- DivX DivX ( 隨選視訊 ] > [ 通用設定 ] > [ DIVX(R) )
- (
- [ 偏好設定 ] > [ DivX 字幕 ] )
- 45
- 4GB DivX

## 播放音樂

備註

•

◀

### 控制曲目

- 1
- 2

按鈕	動作
	/
	/
	/



## 播放 MP3/WMA 音樂

MP3/WMA ( .mp3 .wma )

- 1 MP3/WMA
  - 2 USB
  - 3 DISC USB
  - 4 OK
- [ ]
- OK

### 備註

- CD
- MP3PRO (ID3)
- WMA 數位內容管理 (DRM)
- /

### 小秘訣

- - [ 偏好設定 ] > [ MP3/JPEG 瀏覽 ]

## 播放相片

### 播放相片幻燈片

JPEG ( .jpeg .jpg )

- 1 JPEG USB
- 2 DISC USB Kodak
- 3 JPEG
- 4 INFO / /



- 
- 
- 
- OK
- 4 MENU

中文(繁体)

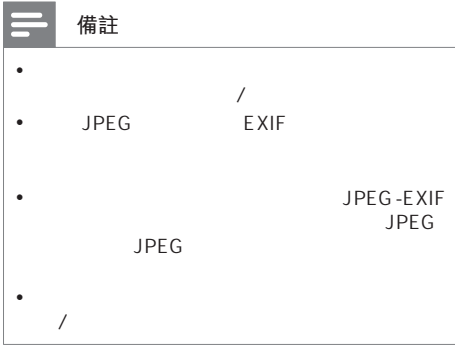

### 控制相片播放

1  
2

按鈕	動作
	.

### 播放音樂幻燈片

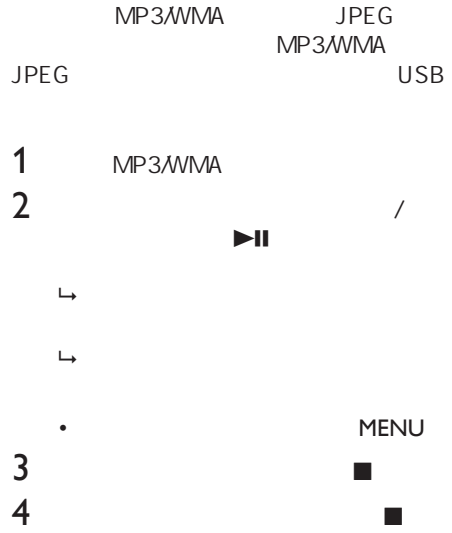

## 從 USB 裝置播放

MP3 / WMA / DivX (Ultra) / JPEG

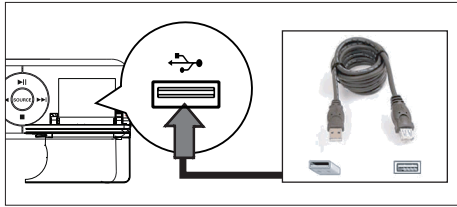

- 1 PTP / USB / USB
- 2 USB
- 3
- 4 USB



### 小秘訣

- USB / USB
- USB / USB
- USB HDD / USB HDD
- PTP / PC

## 從可攜式媒體播放器播放

( MP3 )

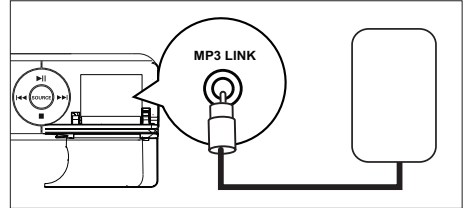

- 1 3.5mm MP3 LINK ( )
- 2 AUX / MP3 LINK / MP3 LINK'
- 3 .
- 4 STOP



### 備註

- 
- /

## 播放收音機

FM  
FM 75Ω

DVD  
FM

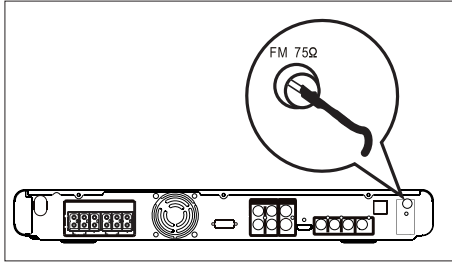

### 小秘訣

- FM ( ) FM
- VCR

## 首次調整

' RADIO' ( )

1 RADIO  
↳ ' AUTO INSTALL ... PRESS  
PLAY] ( ... 播放)

2 

↳

↳

•



### 備註

- 40
  - 5
- INSTALL ( ) AUTO

## 收聽 FM 收音機

1 RADIO

2

按鈕	動作
	
	/
	.



.

## 重新設置所有電台。

- 1 RADIO
- 2 PROGRAM START  
( )  
↳

☰ 備註

• CHECK ANTENNA ( )  
5

## 搜尋並分別儲存電台

- 1 RADIO
- 2 ◀▶▶▶  
↳ SEARCH ( )
- 3 2
- ▲▼  
4 PROGRAM 20
- 5 ◀▶ ( )
- 6 PROGRAM

## 變更調柵

/ FM  
50kHz 100 kHz

☰ 備註

•  
•

- 1 RADIO FM
- 2 ■
- 3 ▶▶ GRID 9 ( )  
9) GRID 10 ( 10)  
• GRID 9 ( 9) 50 kHz  
GRID 10 ( 10)  
100 kHz

中文(繁体)

# 6 調節聲音

## 調整聲音

- 1 VOL + -

## 選取環繞音效

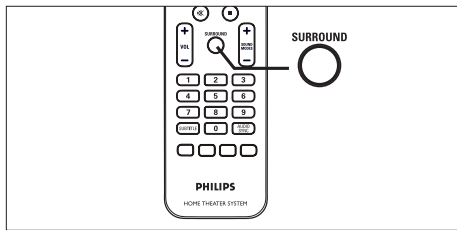

- 1 SURROUND

選項	說明
	DTS ( )
	, II

## 選擇預先定義的音效模式

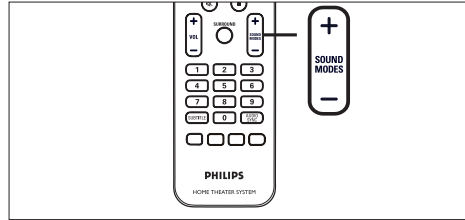

- 1 SOUND MODES + -

視訊/音樂	說明
/	
	DVD
/Lounge	
/	
	/
/	

## 調整麥克風音量

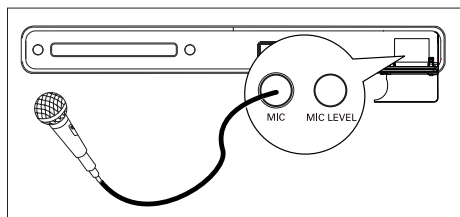

- 1 MIC ( )
- 2
- 3 MIC LEVEL  
↳ LEVEL XX
- 4 ( VOL + - )
- .



備註

- 10

## 關閉人聲 (取消聲音)

- 1 VOCAL VOICE  
CANCEL ( )



備註

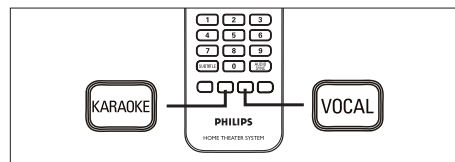

- MP3 JPEG SACD

## 麥克風設定



- 1
- 2 KARAOKE  
↳ [麥克風設定]
- 3 OK  
[麥克風]  
• [開]-  
• [關]-  
[麥克風音量]  
▲▼  
[迴音級數]  
▲▼  
[音調]  
▲▼  
[得分]  
OK  
• [關]-  
• [基礎]-  
• [中級]-  
• [進階]-
- 4 KARAOKE

# 7 調整設定

符號	選項
	[ 通用設定 ]
	[ 音訊設定 ]
	[ 視訊設定 ]
	[ 偏好設定 ]

## 通用設定

1      OPTIONS  
     ↳      [通用設定]

2      ►

3      OK

通用設定	
	碟片鎖定
	顯示亮度
	畫面顯示語言
	螢幕保護
	睡眠
	DIVX(R) 隨選視訊

4      OK

•      BACK

•      OPTIONS

[ 碟片鎖定 ]

(      40

)

• [ 鎖定 ]-

• [ 不鎖定 ]-

 小秘訣

• [      ]	[      ] >
------------	------------

[ 顯示亮度 ]

• [ 100% ]-

• [ 70% ]-

• [ 40% ]-

LED

[ 畫面顯示語言 ]

[ 螢幕保護 ]

• [ 開 ]-

(      5

)

• [ 關 ]-



[ 睡眠 ]

- [ 關 ] -
- [ 15, 30, 45, 60 分鐘 ] -

 小秘訣

	SLEEP
--	-------

[ DivX(R) 隨選視訊 ]  
DivX®

 小秘訣

	<a href="http://www.divx.com/od">www.divx.com/od</a>	
VOD (            )	DivX	DivX®
	DivX	DivX

## 音訊設定

- 1                  OPTIONS  
                    ↳                  [ 通用設定 ]
  - 2                  ▼                   [ 音訊設定 ]  
                    ▶
  - 3    OK
- | 音訊設定  |        |  |
|---|--------|--|
|  | 揚聲器音量  |  |
|   | 揚聲器延遲  |  |
|  | HDMI音訊 |  |
|   | 光碟升頻   |  |
|  | 音訊同步   |  |
|  |        |  |
- 4    OK
  - 
  - BACK
  - OPTIONS

中文(繁體)

[揚聲器音量]

1. OK
2. ◀▶
3. OK



小秘訣

- 

[揚聲器延遲]

1. OK
2. ◀▶
3. OK



小秘訣

- 1ms 30cm

[HDMI 音訊]

HDMI

- [全部]-

( PCM)

- [關閉]-

[光碟升頻]

- [關]-
- [88.2 kHz (X2)]-



備註

- SURROUND

[音訊同步]

1. OK
2. ◀▶
3. OK

# 視訊設定

- 1      OPTIONS  
    ↳      [ 通用設定 ]
- 2      ▼      [ 視訊設定 ]
- 3                                      OK

視訊設定	
	電視類型
	電視顯示
	逐行掃描
	畫質設定
	HDMI 設定
	隱藏字幕
	
	

- 4                                      OK
- BACK
- OPTIONS

## [ 電視類型 ]

- [ PAL ]-                      PAL
- [ NTSC ]-                      NTSC
- [ 多制式 ]-                      PAL    NTSC

## [ 電視顯示 ]



中文(繁體)

- [ 4:3 Pan Scan ] -
- [ 4:3 信箱 ] -
- [ 16:9 寬螢幕 ] -  
    (                      16:9)

## [ 逐行掃描 ]

- [ 開 ] -
- [ 關 ] -

小秘訣

- -

[ 畫質設定 ]

- [ 標準 ] -
- [ 亮度 ] -
- [ 柔和 ] -
- [ 個人 ] -

OK

[ HDMI 設定 ]

HDMI

HDMI

- [ 寬螢幕格式 ] -

選項	說明
[ 超廣角 ]	
	720p 1080i/ p
[ 4:3 PILLAR BOX ]	
[ 關 ]	

備註

- [ 電視顯示 ] [ 16:9 ]  
寬螢幕

- [ HDMI 視訊 ] -

選項	說明
[ 自動 ]	
[ 480p, 576p, 720p, 1080i, 1080p ]	

備註

- 15 :  
1) ▲ 2) ◀ 3) ZOOM

- [ EasyLink ] -  
HDMI CEC /

選項	說明
[ 自動開機電視 ]	PLAY (
	)
	• [ 關 ]
[ 系統待機 ]	HDMI CEC /
	• [ 拒絕 ]

[ 系統音訊控制 ]

- [ ]  
[ HDMI 輸入對映 ]

[ HDMI 輸入  
對映 ]

1. OK

2. ( AUX1  
AUX2) ▶

3.

OK

備註

•	CEC	HDMI
•	EasyLink	HDMI CEC
•	100%	HDMI CEC

[ 隱藏字幕 ]

• [ 開 ] -

• [ 關 ] -

## 偏好設定

1. OPTIONS  
↳ [ 通用設定 ]

2. ▼ [ 偏好設定 ]

3. OK

偏好設定	
聲音	
字幕	
光碟選單	
節目分級控制	
PBC	
MP3/JPEG瀏覽	
密碼	
DIVX 字幕	▼

中文(繁体)

4. OK

• BACK

• OPTIONS

[ 聲音 ]

DVD

[ 字幕 ]

DVD

[ 光碟選單 ]

DVD

 備註

- 
- DVD /
- [ 其他 ]

4

[ 節目分級控制 ]

DVD DVD

- 
1. OK
  2. OK
  3. 數字鍵 6
- 

 備註

- [ 節目分級控制 ]
- DVD
- ' 8
- DVD DVD

 小秘訣

- [ 密碼 ] [ 偏好設定 ] >

[ PBC ]

PBC VCD/SVCD ( )

- [ 開 ] -
- [ 關 ] -

[ MP3/JPEG 瀏覽 ]

MP3/WMA  
MP3/WMA

- [ 無選單 ] -
- [ 有選單 ] - MP3/WMA

[ 密碼 ]

DVD

變更密碼	
舊密碼	<input type="text"/>
新密碼	<input type="text"/>
確認密碼	<input type="text"/>
<input type="button" value="確認"/>	

---

1. 數字鍵 136900  
[ 舊密碼 ] 6

2. [ 新密碼 ]  
3. [ 確認密碼 ]

---

4. OK

 備註

- 6 136900

[ DivX 字幕 ]

DivX

[ 標準 ]

(Bokmål  
Nynorsk)

[ 中歐 ]

[ 斯拉夫 ]

[ 希臘語 ]

[ 希伯來文 ] 文

[ 中文(簡體) ]

[ 韓文 ]

[ 原廠設定值 ]

[ 碟片鎖定 ] [ 密碼 ] [ 節目分級控制 ]

[ 版本資訊 ]



小秘訣

•

Philips

中文(繁体)



備註

•

Movie.avi  
Movie.sub      Movie.srt

# 8 其他資訊

## 軟體升級

### 1 OPTIONS



2 [偏好設定] > [版本資訊]

OK

3 OPTIONS

4 [www.philips.com/support](http://www.philips.com/support)

5 CD-R  
USB

6 CD-R USB

7 DISC USB

備註

- CD-R USB

8

備註

- 

## 注意

### 清潔光碟

警告!

- 

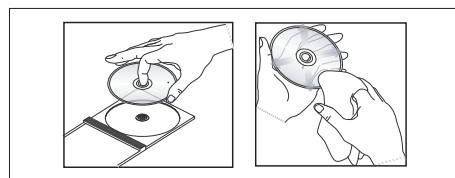



# 規格

## 備註

•
---

### 隨附配件

- 
- 
- 
- 
- 1 2 2 (HTS3569)
- /
- FM

### 擴大機

- ( ) 1000W
- 180 Hz ~ 18 kHz / ± 3dB
- > 60 dB(A-weighted)
- 
- AUX: 400 mV
- MP3 LINK: 400 mV

### 光碟

- 
- 12 /8
- MPEG1/MPEG2 /DivX /DivX Ultra
- DAC 12
- PAL /NTSC
- S/N 56 dB
- DAC 24 /96 kHz
- : 4 Hz - 20 kHz (44.1 kHz)
- 4 Hz - 22 kHz (48 kHz)
- 4 Hz - 44 kHz (96 kHz)
- PCM: IEC 60958
- , DTS: IEC 60958, IEC 61937

### 收音機

- FM 87.5 - 108 MHz (50/100 kHz)
- 26 dB : FM 22 dBf
- : FM 60 dB
- : FM 50 dB
- : FM 3%
- : FM 180 Hz ~ 10 kHz / ± 6dB
- : FM 26 dB (1 kHz)
- : FM 29 dB

### USB

- USB (2.0)
- UMS (USB ) MTP (

### 主裝置

- 110-127 V / 220-240 V, -50-60 Hz
- 180 W
- ( x x ) 435 x 58 x 360 mm
- 4.04

### 揚聲器

- 
- : 3 ohm ( / ), 6 ohm ( )
- :
- 2x 2.5" + 1 x 2"
- / 3"
- 150 Hz - 20 kHz
- HTS3565
  - ( x x )
  - 440 x 105 x 75 ( )
  - / 103 x 203 x 71 ( )
  - 
  - 1.39
  - / 0.56
- HTS3569
  - ( x x )
  - 440 x 105 x 75 ( )
  - / 262 x 1199 x 264 ( )
  - 
  - 1.43
  - / 3.29

### 重低音喇叭

- 3 ohm
- 203 (8" )
- 40 Hz - 150 Hz
- HTS3565
  - ( x x ) 163 x 363 x 369 ( )
  - 5.08
- HTS3569
  - ( x x ) 240 x 352 x 360 ( )
  - 5.08

## 9 疑難排解

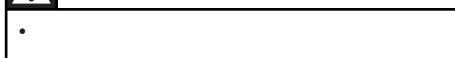

[www.philips.com/welcome](http://www.philips.com/welcome)

---

### 主裝置

此裝置上的按鈕無法使用。

- 

---

### 圖片

沒有畫面。

- 

- 

DISC

DVD

1. ▲
2. ◀
3. AUDIO SYNC ( ) SUBTITLE ( )

---

HDMI 連線沒有畫面。

- 

- 

HDMI

HDMI

HDMI

:

1. ▲
2. ◀
3. ZOOM

## 音效

沒有聲音。

- ( AUX /MP3 LINK USB)

HDMI 連線上沒有音效。

- HDMI HDCP DVI

電視節目沒有音效。

- AUDIO AUDIO AUX /MP3 LINK

## 播放

無法播放 DivX 視訊檔案。

- DivX DivX
- DivX

螢幕長寬比與電視顯示設定不一致。

- DVD

DivX 字幕未正確顯示。

- 
- 
- 1. OPTIONS
- 2. ► [ DivX 字幕 ]
- 3.

無法讀取 USB 快閃磁碟機的內容。

- USB
- ( NTFS)

# 10 詞彙表

長寬比

4 3

16 9 Letter box

4 3

DivX

DivX DivX

MPEG-4

DivX

Networks Inc.

杜比數位

Dolby Laboratories

( )

HDMI

High-Definition Multimedia Interface

(HDMI )

HDMI DVI

HDMI

) HDMI

HDCP (

DVI

HDCP

(High-bandwidth

Digital Content Protection)

JPEG

Joint

Photographic Expert Group

JPG

JPEG

MP3

MP3

3 (Motion

Picture Experts Group 1 (

MPEG-1)

Audio Layer3)

MP3

CD-R CD-RW

CD

10

.MP3

MPEG

PBC

VCD/ VCD

PCM

逐行掃描

WMA

Windows Media™ Audio

Microsoft

Corporation

Windows Media Player

9

Windows Media Player for Windows XP

WMA

WMA