

Always there to help you

Register your product and get support at
www.philips.com/welcome



M888



Extended user documentation

PHILIPS

Contents

1 Important safety instructions 3

2 Your phone 5

- What is in the box 5
- Overview of the phone 5
- Overview of the base station 7

3 Get started 8

- Connect the base station 8
- Install the handset 8
- Configure your phone (country dependent) 9
- Change the remote access PIN/passcode 9
- Charge the handset 10
- Check the battery level 10
- What is standby mode? 10
- Check the signal strength 10

4 Main menu icons 12

5 Display icons 13

6 Calls 14

- Make a call 14
- Answer a call 14
- End a call 15
- Adjust the earpiece/speaker volume 15
- Mute the microphone 15
- Turn the speaker on or off 15
- Make a second call 15
- Answer a second call 15
- Switch between two calls 15
- Make a conference call with the external callers 16

7 Intercom and conference calls 17

- Make a call to another handset 17
- Transfer a call 17
- Make a conference call 17

8 Text and numbers 19

- Enter text and numbers 19
- Switch between uppercase and lowercase 19

9 Phonebook 20

- View the phonebook 20
- Search a record 20
- Call from the phonebook 20
- Access the phonebook during a call 20
- Add a record 20
- Edit a record 21
- Set the personalized melody 21
- Set the speed dial keys 21
- Delete a record 22
- Delete all records 22
- Add a contact to the exception list 22

10 Call log 23

- Call list type 23
- View the call records 23
- Save a call record to the phonebook 23
- Return a call 23
- Delete a call record 24
- Delete all call records 24

11 Redial list 25

- View the redial records 25
- Save a redial record to the phonebook 25
- Redial a call 25
- Delete a redial record 25
- Delete all redial records 25

12 Phone settings 26

- Set the date and time 26
- Auto answer 26
- ECO mode 26
- ECO+ mode 26
- Name the handset 27
- Set the display language 27

13 Alarm clock 28

- Set the alarm 28

Turn off the alarm	28	Use GAP standard compliance	44
		Compliance with EMF	44
14 Display settings	29	Disposal of your old product and batteries	44
15 Sound settings	30	21 Frequently asked questions	46
Set the handset's ringtone volume	30	22 Appendix	48
Set the handset's ringtone	30	Text and number input tables	48
Silent mode	30		
Set the key tone	31		
Set the battery tone	31		
Set the docking tone	31		
Set the sound profile	31		
16 Baby monitor	32		
Activate/Deactivate the baby unit	32		
Send an alert	32		
Set the baby cry level	33		
17 Telephone answering machine	34		
Turn the answering machine on or off	34		
Set the answering machine language	34		
Set the answer mode	34		
Announcements	34		
Incoming messages	35		
18 Services	39		
Auto conference	39		
Call barring	39		
Call list type	40		
Auto prefix	40		
Network type	40		
Select the recall duration	40		
Dial mode	41		
First ring	41		
Auto clock	41		
Register additional handsets	42		
Unregister handsets	42		
Restore default settings	42		
19 Technical data	43		
20 Notice	44		
Declaration of conformity	44		

1 Important safety instructions

Power requirements

- This product requires an electrical supply of 100-240 volts AC. In case of power failure, the communication can be lost.
- The voltage on the network is classified as TNV-3 (Telecommunication Network Voltages), as defined in the standard EN 60950.



Warning

- The Electrical network is classified as hazardous. The only way to power down the charger is to unplug the power supply from the electrical outlet. Ensure that the electrical outlet is always easily accessible.

To avoid damage or malfunction



Caution

- Use only the power supply listed in the user instructions.
- Use only the batteries listed in the user instructions.
- Risk of explosion if battery is replaced by an incorrect type.
- Dispose of used batteries according to the instructions.
- Do not dispose of batteries in fire.
- Always use the cables provided with the product.
- Do not allow the charging contacts or the battery to come into contact with metal objects.
- Do not let small metal objects come into contact with the product. This can deteriorate audio quality and damage the product.
- Metallic objects may be retained if placed near or on the handset receiver.
- Do not use the product in places where there are explosive hazards.
- Do not open the handset, base station or charger as you could be exposed to high voltages.
- For pluggable equipment, the socket-outlet shall be installed near the equipment and shall be easily accessible.

- Handsfree activation could suddenly increase the volume in the earpiece to a very high level: make sure the handset is not too close to your ear.
- This equipment is not designed to make emergency calls when the power fails. An alternative has to be made available to allow emergency calls.
- Do not allow the product to come into contact with liquids.
- Do not use any cleaning agents containing alcohol, ammonia, benzene, or abrasives as these may harm the set.
- Do not expose the phone to excessive heat caused by heating equipment or direct sunlight.
- Do not drop your phone or allow objects to fall on your phone.
- Active mobile phones in the vicinity may cause interference.

When using the phone as a baby monitor



Caution

- Children should be supervised to ensure that they do not play with the appliance.
- Make sure the baby unit and the cord are always out of reach of the baby (at least 1 metre/3 feet away).
- Keep the parent unit at least 1.5 metres/5 feet away from the baby unit to prevent acoustic feedback.
- Never place the baby unit inside the baby's bed or playpen.
- Never cover the parent unit and the baby unit with anything (e.g. a towel or blanket). Always make sure the cooling vents of the baby unit are free.
- Take every precaution to make sure that your baby can sleep safely.
- This appliance is not intended for use by persons (including children) with reduced physical, sensory or mental capabilities, or lack of experience and knowledge, unless they have been given supervision or instruction concerning use of the appliance by a person responsible for their safety.
- If you place the parent unit next to a transmitter or other DECT appliance (e.g. a DECT telephone or wireless router for the internet), the connection with the baby unit may be lost. Move the baby monitor further away from the other wireless appliances until the connection is restored.
- This baby monitor is intended as an aid. It is not a substitute for responsible and proper adult supervision and should not be used as such.

About operating and storage temperatures

- Operate in a place where temperature is always between 0°C to +40°C (up to 90% relative humidity).

- Store in a place where temperature is always between -20°C and $+45^{\circ}\text{C}$ (up to 95% relative humidity).
- Battery life may be shorter in low temperature conditions.

2 Your phone

Congratulations on your purchase and welcome to Philips!

To fully benefit from the support that Philips offers, register your product at www.philips.com/welcome.

What is in the box



Handset**

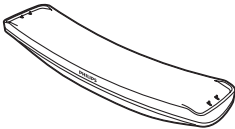

Base station



Power adapter**



Line cord*



Guarantee



Short user manual

Note

- * In some countries, you have to connect the line adapter to the line cord, then plug the line cord to the telephone socket.
- ** In multi-handset packs, there are additional handsets, chargers and power adapters.

Overview of the phone

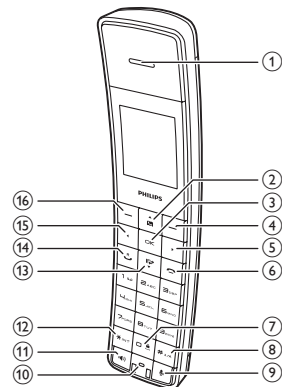

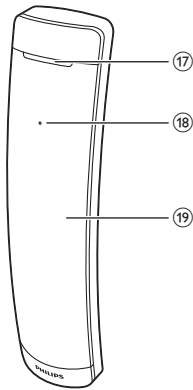

1 Earpiece



- Scroll up on the menu.
- Increase the earpiece/speaker volume.
- Access the contacts in standby mode.



- Access the main menu in standby mode.
- Confirm selection.
- Enter the options menu.



- Press to delete individual text or digit. Press and hold to remove all text.
- Cancel operation.
- Enter the redial list in standby mode.
- Change the sound profile during a call.
- Select the function displayed on the handset screen directly above the key.



Move the cursor to the right in editing mode.



- End the call.
- Exit the menu/operation.



- Press to enter a space during text editing.
- Press and hold to lock/unlock the keypad in standby mode.



- Press and hold to enter a pause when editing the contact's name and number.
- Switch to upper/lower case during editing.



Mute or unmute the microphone.



- Turn the speaker phone on/off.
- Make and receive calls through the speaker.



- Press and hold to make an intercom call (for multi-handset versions only).
- Set the dial mode (pulse mode or temporary tone mode).



- Scroll down on the menu.
- Decrease the earpiece/speaker volume.
- Access the call log in standby mode.



- Make and receive calls.
- Recall key



Move the cursor to the left in editing mode.



- Access the main menu in standby mode.
- Confirm selection.
- Enter the options menu.
- Select the function displayed on the handset screen directly above the key.

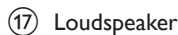

- Off: no new event
- Flashing: new missed calls/new messages on answering machine/new voice mails.
- Flashing once: when putting the handset on the base station.

- Flashing quickly: incoming calls
- Flashing slowly: charging empty batteries.

19 Battery door

Overview of the base station

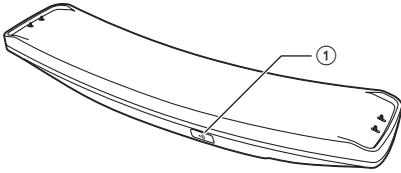

- 1 •))
- Find handsets.
 - Enter the registration mode.

3 Get started

! Caution

- Make sure that you have read the safety instructions in the 'Important safety instructions' section before you connect and install your handset.

Connect the base station

! Warning

- Risk of product damage! Ensure that the power supply voltage corresponds to the voltage printed on the back or the underside of the phone.
- Use only the supplied power adapter to charge the batteries.

☰ Note

- If you subscribe to the digital subscriber line (DSL) high speed internet service through your telephone line, ensure you install a DSL filter between the telephone line cord and the power socket. The filter prevents noise and caller ID problems caused by the DSL interference. For more information on the DSL filters, contact your DSL service provider.
- The type plate is located on the bottom of the base station.

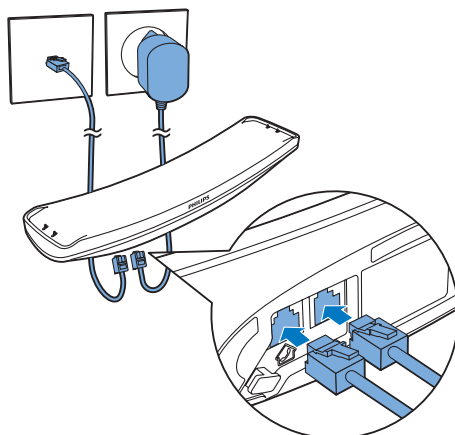

Install the handset

The batteries are pre-installed in the handset. Pull the battery tape off from the battery door before charging.

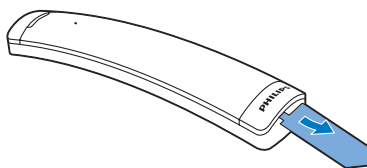

! Caution

- Risk of explosion! Keep batteries away from heat, sunshine or fire. Never discard batteries in fire.
- Use only the supplied batteries.
- Risk of decreased battery life! Never mix different brands or types of batteries.

☰ Note

- Charge the batteries for 8 hours before first use.
- If the handset becomes warm when the batteries are being charged, it is normal.

- 1 Connect each end of the power adapter to:
 - the DC input jack at the bottom of the base station;
 - the power socket on the wall.
- 2 Connect each end of the line cord to:
 - the telephone socket at the bottom of the base station;
 - the telephone socket on the wall.

Warning

- Check the battery polarity when inserting in the battery compartment. Incorrect polarity may damage the product.

Configure your phone (country dependent)

- 1 When using your phone for the first time, you see a welcome message.
- 2 Press [OK].

Set the country/language



Select your country/language, then press [OK] to confirm.

↳ The country/language setting is saved.



Note

- The country/language setting option is country dependent. If no welcome message is displayed, it means the country/language setting is preset for your country. Then you can set the date and time.

To re-set the language, see the following steps.

- 1 Select [Menu].
- 2 Press  /  to select >  > [Language], then press [OK] to confirm.
- 3 Select a language, then press [OK] to confirm.
↳ The setting is saved.

Set the date and time

- 1 Select [Menu].
- 2 Press  /  to select , then press [OK] to confirm.
- 3 Select [Date & time], then press [OK] to confirm.





- 4 Select [Set date]/[Set time], then press [OK] to confirm.
- 5 Press the numeric buttons to enter the date and time.

Note

- If the time is in 12-hour format, press  to select [am] or [pm] (Country dependent).

- 6 Press [OK] to confirm.

Set the date and time format

- 1 Select [Menu].
- 2 Press  /  to select , then press [OK] to confirm.
- 3 Select [Date & time], then press [OK] to confirm.
- 4 Select [Date format] or [Time format].
- 5 Press  /  to select [DD/MM/YYYY] or [MM-DD-YYYY] as the date display, and [12 Hours] or [24 Hours] as the time display. Then press [OK] to confirm.
↳ The setting is saved.



Note

- The date and time format setting is country dependent.

Change the remote access PIN/passcode

Note

- The default answering machine remote access PIN/passcode is 0000 and it is important to change it to ensure the security.

- 1 Select [Menu].
- 2 Press  /  to select , then press [OK] to confirm.

- 3 Select **[Remote access]** > **[Change PIN]**, then press **[OK]** to confirm.
- 4 Enter the old PIN/passcode, then press **[OK]** to confirm.
- 5 Enter the new PIN/passcode, then press **[OK]** to confirm.
- 6 Enter the new PIN/passcode again, then press **[Save]** to confirm.
 - ↳ The setting is saved.

Charge the handset

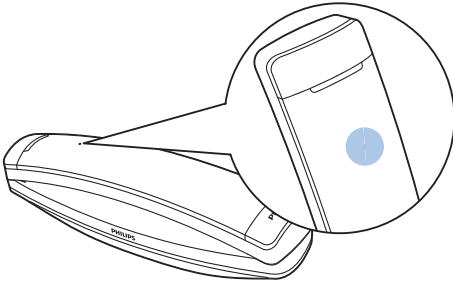

Charge your handset by docking it in either direction. When the handset is placed correctly on the base station, you hear a docking tone (see 'Set the docking tone' on page 31). The LED at the back of the handset flashes once.

↳ The handset starts charging.





Note

- Charge the batteries for 8 hours before first use.
- If the handset becomes warm when the batteries are being charged, it is normal.
- Over time, capacity of batteries decreases. This is a normal battery behavior.

Your phone is now ready to use.

Check the battery level

The battery icon displays the current battery level.





-  When the handset is off the base station/charger, the bars indicate the battery level (from full to low).
-  When the handset is on the base station/charger, the bars flash until charging is complete.
-  When the handset is on the base station/charger, the bars flash until charging is complete.
-  When the handset is on the base station/charger, the bars flash until charging is complete.
-  The empty battery icon flashes. The battery is low and needs recharging.

If you are on the phone, you hear warning tones when the batteries are almost empty. The handset turns off when the batteries are completely empty.

What is standby mode?

Your phone is in standby mode when it is idle. When the handset is off the charging cradle, the standby screen displays the date and time. When the handset is on the charging cradle, the standby screen displays the time as a screen saver.

Check the signal strength

-  The number of bars indicates the connection status between the handset and base station. The more bars are shown, the better the connection is.
- 
- 
- 

- Make sure the handset is linked to the base station before you make or receive calls and carry out the functions and features.
- If you hear warning tones when you are on the phone, the handset is almost out of battery or the handset is out of range.

Charge the battery or move the handset closer to the base station.











Note

- When **ECO+** is on, the signal strength is not displayed.











4 Main menu icons



The following is an overview of the menu options that are available in your M888. For detailed explanation of the menu options, see the corresponding sections in this user manual.

Icon	Descriptions
	[Phonebook] - Add, edit, manage phonebook entries etc.
	[Sounds] - Set the ring volume, ring tone, key tone etc.
	[Display] - Set the brightness, clock, backlight of the screen.
	[Phone setup] - Set the date and time, ECO mode, handset name and display language.
	[Alarm] - Set date and time, alarm, alarm tone etc.
	[Services] - Set the auto conference, auto prefix, network type, recall time, auto clock, call services etc. The services are network and country dependent.
	[Baby monitor] - Set the alert to an external line, a contact from the phonebook or other handsets and the baby cry level.
	[Answer machine] - Setup, listen to, delete phone messages, etc.

5 Display icons

In standby mode, the icons shown on the main screen tell you what features are available on your handset.

Icon	Descriptions
	When the handset is off the base station/charger, the bars indicate the battery level (from full to low).
	When the handset is on the base station/charger, the bars keep scrolling until charging is complete.
	The empty battery icon flashes and you hear an alert tone. The battery is low and needs recharging.
	The number of bars indicates the connection status between the handset and base station. The more bars are shown, the better the signal strength is.
	It remains steadily on beside the unread missed call record when browsing the call log.
	It flashes when there is a new missed call. It remains steadily on when browsing missed calls in call log.
	The alarm is activated.
	The silent mode is set, but is outside of active period.
	<ul style="list-style-type: none">• The ringer is off.• The silent mode is set and within active period (the phone does not ring).
	Answering machine: it flashes when there is a new message. It is displayed when the telephone answering machine is turned on.
	It flashes when there is a new voice message. It remains steadily on when the voice messages are already viewed in the call log. The icon is not shown when there is no voice message.

	The baby monitor is activated.
	The ECO mode is activated.
	The ECO+ mode is activated.

6 Calls

Note

- When the power fails, the phone cannot access emergency services.

Tip

- Check the signal strength before you make a call or when you are in a call (see 'Check the signal strength' on page 10).



Make a call

You can make a call in these ways:



- Normal call
- Predial call
- Call through the speed dial key

You can also make a call from the redial list (see 'Redial a call' on page 25), phonebook list (see 'Call from the phonebook' on page 20) and call log (see 'Return a call' on page 23).

Normal call

- 1 Press  or .
- 2 Dial the phone number:
 - ↳ The number is dialed out.
 - ↳ The duration of your current call is displayed.

Predial call

- 1 Dial the phone number
 - To erase a digit, press **[Clear]**.
 - To enter a pause, press and hold **# n/A**.
- 2 Press  or  to dial out the call.

Call through the speed dial key

If you have already pre-saved a contact in the speed dial key, press and hold the key to make a call.

Tip



- For information of how to set the speed dial keys, see the chapter 'Phonebook', section 'Set the speed dial keys'.

Note

- The talk time of your current call is displayed on the call timer.
- If you hear warning tones, the phone is almost out of battery or out of range. Charge the battery or move the phone close to the base station.

Answer a call

When the phone rings, you can select from the following options:

- press  or  to answer the call.
- pick up the phone to answer the call when you activate the auto answer feature (see 'Auto answer' on page 26).
- select **[Divert]** to send incoming call to the answering machine.
- select **[Silent]** to turn off the ringer of the current incoming call.

Warning

- When the handset rings or when the handsfree is activated, keep the handset away from your ear to avoid ear damage.

Note

- The caller ID service is available if you have registered to the caller ID service with your service provider.



Tip

- When there is a missed call, a notification message appears.

End a call

You can end a call in these ways:

- Press ; or
- Place the handset to the base station or charging cradle.

Adjust the earpiece/speaker volume

Press / on the handset to adjust the volume during a call.

- ↳ The earpiece/speaker volume is adjusted and the phone is back to the call screen.

Mute the microphone

- 1 Press during a call.
 - ↳ The handset displays **[Mute on]**.
 - ↳ The caller cannot hear you, but you can still hear his voice.
- 2 Press again to unmute the microphone.
 - ↳ You can now communicate with the caller.

Turn the speaker on or off

Press .

Make a second call

Note

- This service is network dependent.

- 1 Press during a call.
 - ↳ The first call is put on hold.
- 2 Dial the second number.
 - ↳ The number displayed on the screen is dialed out.

Answer a second call

Note

- This service is network dependent.

When there is a periodical beep to notify you of an incoming call, you can answer the call in these ways:

- 1 Press and to answer the call.
 - ↳ The first call is put on hold, and you are now connected to the second call.
- 2 Press and to end the current call and answer the first call.

Switch between two calls

Note

- This service is network dependent.

You can switch your calls in these ways:

- Press and ; or
- Press **[Option]** and select **[Switch calls]**, then press **[OK]** again to confirm.
 - ↳ The current call is put on hold, and you are now connected to the other call.

Make a conference call with the external callers



Note

- This service is network dependent. Check with the service provider for additional charges.

When you are connected to two calls, you can make a conference call in these ways:

- Press **☺**, then **☰**; or
- Press **[Option]**, select **[Conference]** and then press **[OK]** again to confirm.
 - ↳ The two calls are combined and a conference call is established.

7 Intercom and conference calls

Note

- This feature is available for multi- handset versions only.

An intercom call is a call to another handset that shares the same base station. A conference call involves a conversation between you, another handset user and the outside callers.

Make a call to another handset

Note

- If the base station only has 2 registered handsets, press and hold ***INT** to make a call to another handset.

- 1 Press and hold ***INT**.
↳ The handsets available for intercom are displayed.
- 2 Select a handset, then press **[OK]** to confirm.
↳ The selected handset rings.
- 3 Press **☎** on the selected handset.
↳ The intercom is established.
- 4 Press **[Cancel]** or **☎** to cancel or end the intercom call.

Note

- If the selected handset is busy, **[Busy]** is displayed on the handset screen.

While you are on the phone

You can go from one handset to another during a call:

- 1 Press and hold ***INT**.
↳ The current caller is put on hold.
- 2 Select a handset, then press **[OK]** to confirm.
↳ Wait for the other side to answer your call.

Switch between calls

Press **[Extern]** to switch between the outside call and the intercom call.

Transfer a call

Note

- If the base station only has 2 registered handsets, press and hold ***INT** to transfer a call to another handset.

- 1 Press and hold ***INT** during a call.
↳ The handsets available for intercom are displayed.
- 2 Select a handset, then press **[OK]** to confirm.
- 3 Press **☎** when the other side answers your call.
↳ The call is now transferred to the selected handset.

Make a conference call

A 3-way conference call is between you, another handset user and the outside callers. It requires two handsets to share the same base station.

During an external call

- 1 Press and hold ***INT** to initiate an internal call.
 - ↳ The external caller is put on hold.
 - ↳ For multi-handset versions, The handsets available for intercom are displayed. Then go to step 2.
 - ↳ For two-handset versions, the other handset rings. Then go to step 3.
- 2 Select a handset, then press **[OK]** to confirm.
 - ↳ The selected handset rings.
- 3 Press **☺** on the selected handset.
 - ↳ The intercom is established.
- 4 Press **[Conf]**.
 - ↳ You are now in a 3-way conference call with an external call and a selected handset.
- 5 Press **☺** to end the conference call.

Note

- Press **☺** to join an ongoing conference with another handset if **[☺] > [Conference]** is set to **[Auto]**.

During the conference call

- Press **[Int.]** to put the external call on hold and go back to the internal call.
 - ↳ The external call is put on hold.
- Press **[Conf]** to establish the conference call again.

Note

- If a handset hangs up during the conference call, the other handset remains connected to the external call.

8 Text and numbers

You can enter text and numbers for handset name, phonebook records, and other menu items.

Enter text and numbers

- 1 Press once or several times on the alphanumeric key to enter the selected character.
- 2 Press **[Clear]** to delete the character: Press ◀/▶ to move the cursor left and right.
- 3 Press **□** to add a space.

Note

- For information on key mapping of characters and numbers, see the chapter 'Appendix'.

Switch between uppercase and lowercase

By default, the first letter of each word in a sentence is uppercase and the rest is lowercase. Press **#** to switch between the uppercase and lowercase letters.

9 Phonebook





This phone has a phonebook that stores up to 250 records. You can access the phonebook from the handset. Each record can have a name up to 16 characters long and a number up to 24 digits long.

There are 9 direct access memories (keys 1 to 9). Depending on your country, keys 1 and 2 are preset to the voice mail number and information service number of your service provider respectively. When you press and hold on the key in standby mode, the saved phone number is dialed automatically.

View the phonebook

Note

- You can view the contact list on one handset only each time.

- 1 There are two ways to access the phonebook list:
 - press ;
 - select **[Menu]**. Press  /  to select , then press **[OK]** to confirm.
- 2 Select **[Option]** > **[View]**, then press **[OK]** to view the available information.



Search a record



You can search the phonebook records in these ways:

- Scroll the contact list.
- Enter the first character of the contact.





Scroll the contact list

- 1 There are two ways to access the phonebook list:
 - press ;







- select **[Menu]**. Press  /  to select , then press **[OK]** to confirm.

- 2 Press  /  to scroll through the contact entries.

Enter the first character of a contact

- 1 There are two ways to access the phonebook list:
 - press ;
 - select **[Menu]**. Press  /  to select , then press **[OK]** to confirm
- 2 Press the alphanumerical key that matches the character:
 - ↳ The first record that starts with this character is displayed.

Call from the phonebook

- 1 There are two ways to access the phonebook list:
 - press ;
 - select **[Menu]**. Press  /  to select , then press **[OK]** to confirm.
- 2 Select a contact in the phonebook list.
- 3 Press  or  to make the call.

Access the phonebook during a call

- 1 Press **[Option]** and select **[Phonebook]**.
- 2 Press **[OK]** to confirm.
- 3 Select a contact, press **[Option]**, then press **[View]** to view the number.

Add a record

- 1 There are two ways to access the phonebook list:
 - press ;

- select **[Menu]**. Press / to select , then press **[OK]** to confirm.
- 2 Select **[Option]** > **[Add new]**, then press **[OK]** to confirm.
 - 3 Enter the name, then press **[OK]** to confirm.
 - 4 Enter the number, then press **[Save]** to confirm
↳ Your new record is saved.

Tip

- If your phonebook memory is full, the handset displays a notification message. Delete some records to add new ones.
- Press and hold **#3377** to insert a pause.
- Press **#3377** to switch between the uppercase and lowercase letters.

Note

- The phonebook overwrites the old number with the new number.
- Press **[Clear]** to delete the character.
- Press / to move the cursor left and right.

Edit a record

- 1 There are two ways to access the phonebook list:
 - press ;
 - select **[Menu]**. Press / to select , then press **[OK]** to confirm.
- 2 Select **[Option]** > **[Edit]**, then press **[OK]** to confirm.
- 3 Edit the name, then press **[OK]** to confirm.
- 4 Edit the number, then press **[Save]** to confirm.
↳ The record is saved.

Set the personalized melody

You can personalize the melody played when someone in the phonebook calls you.

Note

- Make sure you have subscribed to caller identification before you use this feature.





- 1 There are two ways to access the phonebook list:
 - press ;
 - select **[Menu]**. Press / to select , then press **[OK]** to confirm.
- 2 Select a contact, then press **[Option]** > **[Select melody]**.
- 3 Press **[OK]** to set or change the melody for the contact.
- 4 Select a melody for the contact, then press **[OK]** to confirm.
↳ The melody is set.



Set the speed dial keys

You can assign and save the number of your contact to a key. Then you can press and hold on the key in standby mode to dial the saved phone number automatically.

- 1 There are two ways to access the phonebook list:
 - press ;
 - select **[Menu]**. Press / to select , then press **[OK]** to confirm.
- 2 Select a contact, then press **[Option]** > **[Speed dial]**, then press **[OK]** to confirm.
- 3 Press / to select and assign the contact to an available location, then press **[OK]** to confirm.
↳ The speed dial key is set.

Delete a record

- 1 There are two ways to access the phonebook list:
 - Press  ;
 - select **[Menu]**. Press  /  to select , then press **[OK]** to confirm.
- 2 Select a contact, then select **[Option]** > **[Delete]**. Press **[OK]** to confirm.
 - ↳ A confirmation request is displayed on the handset.
- 3 Select **[OK]** to confirm.
 - ↳ The record is deleted.





- select **[Menu]**. Press  /  to select , then press **[OK]** to confirm.

- 2 Select a contact, then select **[Option]** > **[Set exception]**.
- 3 Press **[OK]** to confirm.
 - ↳ The setting is saved.

Tip

- For further information on how to set the silent mode and exclude the contacts from silent mode, see the chapter 'Sound settings', section 'Silent mode'.

Delete all records

- 1 There are two ways to access the phonebook list:
 - Press  ;
 - select **[Menu]**. Press  /  to select , then press **[OK]** to confirm.
- 2 Select **[Option]** > **[Delete all]**.
- 3 Press **[OK]** to confirm.
 - ↳ A confirmation request is displayed on the handset.
- 4 Press **[OK]** to confirm.
 - ↳ All records are deleted.

Add a contact to the exception list

You can select a contact to the exception list. When the contact who is added into the exception list calls you, the phone rings immediately even though you activate the silent mode.

- 1 There are two ways to access the phonebook list:
 - press  ;

10 Call log



The call log stores the call history of all missed or received calls. The incoming call history includes the name and number of the caller, call time, and date. This feature is available if you have registered to the caller ID service with your service provider.

Your phone can store up to 50 call records. The call log icon on the handset and base station flashes to remind you of any unanswered calls. If the caller allows the display of his identity, you can view his name or number. The call records are displayed in chronological order with the most recent received call at the top of the list.

Note

- Make sure that the number in the call list is valid before you can call back directly from the call list.



The following icon shown on the screen informs you if you have missed calls.

Icons	Description
	It remains steadily on beside the unread missed call record when browsing the call log.
	It flashes when there is a new missed call or when browsing new missed calls. It remains steadily on when the missed call in the call log is read.

Call list type

You can set if you can see all calls or missed calls from the call log.

Select the call list type

- 1 Select **[Menu]**.
- 2 Press  /  to select , then press **[OK]** to confirm.

- 3 Select **[Call list type]**, then press **[OK]** to confirm.
- 4 Select an option, then press **[OK]** to confirm.



View the call records

- 1 Press  in standby mode.
- 2 Select **[Incoming calls]**.
↳ The incoming call log is displayed.
- 3 Select a record, then select **[Option]** > **[View]** > **[OK]** to view the available information.

Save a call record to the phonebook

- 1 Press  in standby mode.
- 2 Select **[Incoming calls]**.
↳ The incoming call log is displayed.
- 3 Select a record, then select **[Option]**.
- 4 Select **[Save number]**, then press **[OK]** to confirm.
- 5 Enter and edit the name, then press **[OK]** to confirm.
- 6 Enter and edit the number, then press **[Save]** to confirm.
↳ The record is saved.

Return a call

- 1 Press  in standby mode.
- 2 Select **[Incoming calls]**.
↳ The incoming call log is displayed.
- 3 Select a record on the list.
- 4 Press  to make the call.

Delete a call record

- 1 Press **☰** in standby mode.
- 2 Select **[Incoming calls]**.
↳ The incoming call log is displayed.
- 3 Select a record, then select **[Option]**.
- 4 Select **[Delete]**, then press **[OK]** to confirm.
↳ A confirmation request is displayed on the handset.
- 5 Press **[OK]** to confirm.
↳ The record is deleted.

Delete all call records

- 1 Press **☰** in standby mode.
- 2 Select **[Incoming calls]**.
↳ The incoming call log is displayed.
- 3 Select **[Option] > [Delete all]**, then press **[OK]** to confirm.
↳ A confirmation request is displayed on the handset.
- 4 Press **[OK]** to confirm.
↳ All records are deleted.

11 Redial list

The redial list stores the call history of dialed calls. It includes the names and/or numbers you have called. This phone can store up to 20 redial records.

View the redial records

Press **[Redial]**.

↳ The dialed calls list is displayed.

Save a redial record to the phonebook

- 1 Press **[Redial]** to enter the list of dialed calls.
- 2 Select a record, then press **[Option]** to confirm.
- 3 Select **[Save number]**, then press **[OK]** to confirm.
- 4 Enter and edit the name, then press **[OK]** to confirm.
- 5 Enter and edit the number; then press **[Save]** to confirm.
↳ The record is saved.

Redial a call

- 1 Press **[Redial]**.
- 2 Select the record you want to call. Press **[Redial]**.
↳ The number is dialed out.

Delete a redial record

- 1 Press **[Redial]** to enter the list of dialed calls.
- 2 Select a record, then press **[Option]** to confirm.
- 3 Select **[Delete]**, then press **[OK]** to confirm.
↳ A confirmation request is displayed on the handset.
- 4 Press **[OK]** to confirm.
↳ The record is deleted.

Delete all redial records

- 1 Press **[Redial]** to enter the list of dialed calls.
- 2 Select **[Option]** > **[Delete all]**, then press **[OK]** to confirm.
↳ A confirmation request is displayed on the handset.
- 3 Press **[OK]** to confirm.
↳ All records are deleted.



12 Phone settings



You can customize the settings to make it your own phone.

Set the date and time

For further information, see chapter 'Get started', sections 'Set the date and time' and 'Set the date and time format'.



Auto answer

When you activate the auto answer feature, you can connect to the incoming call automatically once you pick up the handset. When you deactivate this feature, you have to press  or  to answer the incoming call.

- 1 Select **[Menu]**.
- 2 Press  /  to select , then press **[OK]** to confirm.
- 3 Select **[Auto answer]**, then press **[OK]** to confirm.
- 4 Select **[On]/[Off]**, and press **[OK]** to confirm.
↳ The setting is saved.

ECO mode

The **ECO** mode reduces the transmission power of the handset and base station when you are on a call or when the phone is in standby mode.

- 1 Select **[Menu]**.
- 2 Press  /  to select , then press **[OK]** to confirm.
- 3 Select **[Eco mode]**, then press **[OK]** to confirm.



- 4 Select **[On]/[Off]**, and press **[OK]** to confirm.
↳ The setting is saved.
↳ **eco** is displayed in standby mode.

Note

- When **ECO** mode is set to **[On]**, the connection range between the handset and the base station can be reduced.

ECO+ mode

When the **ECO+** mode is activated, it eliminates the transmission power of the handset and base station in standby mode.

- 1 Select **[Menu]**.
- 2 Press  /  to select , then press **[OK]** to confirm.
- 3 Select **[ECO+ mode]**, then press **[OK]** to confirm.
- 4 Select **[On]/[Off]**, and press **[OK]** to confirm.
↳ The setting is saved.

Note

- Make sure that all the handsets registered to the base station are M888 in order to have the **ECO+** feature functioning properly.
- When **ECO+** is activated, the standby time is reduced. This is because in **ECO+** mode the base station is not transmitting any signal in standby mode; therefore the handset needs to "listen" more frequently for signals from the base station to detect incoming calls or other requests from the base station. The time it takes for the handset to access features like call setup, call log, paging, and phonebook browsing is also delayed. The handset will not alert you to link loss in case of power loss or moving out of range.

The following table shows you the current status of the handset screen with different **ECO** mode and **ECO+** mode settings.

ECO mode	ECO+ mode	Handset icon display
[Off]	[Off]	eco and eco+ are off.
[Off]	[On]	eco+ is displayed only after the ECO+ mode is activated during standby mode .
[On]	[Off]	eco is displayed.
[On]	[On]	eco is displayed and changed to eco+ when the ECO+ mode is activated in standby mode.

- Press / to select , then press [OK] to confirm.
- Select [Language], then press [OK] to confirm.
- Select a language, then press [OK] to confirm.
↳ The setting is saved.

Name the handset

The name of the handset can be up to 16 characters.

- Select [Menu].
- Press / to select , then press [OK] to confirm.
- Select [Phone name], then press [OK] to confirm.
- Enter or edit the name. To erase a character, select [Clear].
- Press [Save] to confirm.
↳ The setting is saved.



Note

- You can see the handset name in standby mode only after you have set it through this menu.

Set the display language



Note





- This feature only applies to models with multiple-language support.
- Languages available vary from country to country.

- Select [Menu].

13 Alarm clock

Your phone has a built-in alarm clock. Check the information below to set your alarm clock.



Set the alarm

- 1 Select **[Menu]**.
- 2 Press  /  to select , then press **[OK]** to confirm.
- 3 Select **[On/off]** > **[On]/[Off]**, then press **[OK]** to confirm.
- 4 Select **[Alarm time]**, then press **[OK]** to confirm.
- 5 Enter an alarm time, then press **[OK]** to confirm.
- 6 Select **[Repetition]**, then press **[OK]** to confirm.
- 7 Select an alarm occurrence, then press **[OK]** to confirm.
- 8 Select **[Alarm tone]**, then press **[OK]**.
- 9 Select a tone from options, then press **[OK]** to confirm.
↳ The alarm is set and  is displayed on the screen.



Tip

- Press ***INT** to switch between **[am]/[pm]** (Country dependent).

- 2 Press  /  to select , then press to confirm.
- 3 Select **[On/off]** > **[Off]**, then press **[OK]** to confirm.
↳ The setting is saved.

When the alarm rings

- Press **[Off]** to turn off the alarm.
- Press **[Snooze]** (or any key except **[Off]**) to snooze.
↳ The alarm rings again after 5 minutes. After you snooze it for 3 times, the snooze function is off.

Turn off the alarm

Before the alarm rings



- 1 Select **[Menu]**.

14 Display settings

You can change the display of the phone during standby mode.



Set the brightness

You can set the brightness of the handset screen to different levels.

- 1 Select **[Menu]**.
- 2 Press  /  to select , then press **[OK]** to confirm.
- 3 Select **[Brightness]**, then press **[OK]** to confirm.
- 4 Select an option, then press **[OK]** to confirm.

Set the backlight of the LCD screen

You can set the backlight of the LCD screen and keypad flashing on or off when the phone rings.

- 1 Select **[Menu]**.
- 2 Press  /  to select , then press **[OK]** to confirm.
- 3 Select **[Display]** > **[Visual alert]**, then press **[OK]** to confirm.
- 4 Select **[Flashing on]/[Flashing off]**, then press **[OK]** to confirm.
↳ The setting is saved.

15 Sound settings

Set the handset's ringtone volume

You can select among 5 ringtone volume levels or progressive (that is, the ringtone starts soft and gets louder over time if the call is not answered).

- 1 Select **[Menu]**.
- 2 Press / to select , then press **[OK]** to confirm.
- 3 Select **[Ring volume]**, then press **[OK]** to confirm.
- 4 Select a volume level, then press **[OK]** to confirm.
↳ The setting is saved.



Tip

- When you turn the ringtone off, displays on the screen.

Set the handset's ringtone

You can select from 10 ringtones.

- 1 Select **[Menu]**.
- 2 Press / to select , then press **[OK]** to confirm.
- 3 Select **[Ring Tone]**, then press **[OK]** to confirm.
- 4 Select a ringtone, then press **[OK]** to confirm.
↳ The setting is saved.

Silent mode

You can set your phone to silent mode and enable it for a specific duration when you do not want to be disturbed. When the silent mode is turned on, your phone does not ring or send any alerts or sound.

Note

- When you press to find your handset, or when you activate the alarm, your phone still sends alert even when the silent mode is activated.

- 1 Select **[Menu]**.
- 2 Press / to select , then press **[OK]** to confirm.
- 3 Select **[Silent mode]**, then press **[OK]** to confirm.
- 4 Select **[On/off]** > **[On]/[Off]**, then press **[OK]** to confirm.
↳ The setting is saved.
- 5 Select **[Start & end]**, then press **[OK]** to confirm.
- 6 Set the time, then press **[OK]** to confirm.
↳ The setting is saved.

Note

- When the silent mode is set to **[On]**, is displayed. is displayed during the preset time for the silent mode.

Exclude the contacts from silent mode

You can select the length of ring delay and set the contacts to be excluded from the phonebook. Ring delay is the number of rings that will be muted before the rings become audible on the phone.

- 1 Select **[Menu]**.

- 2 Press / to select , then press [OK] to confirm.
- 3 Select [Silent mode], then press [OK] to confirm.
- 4 Select [Exception], then you can select from these two options:
 - Select [On] to activate, or [Off] to deactivate the silent mode, then press [OK] to confirm.
 - Select [Ring delay], then select an option.
- 5 Press [OK] to confirm.
↳ The setting is saved.

Note

- If [Exception] is set to [On] and [Ring delay] option is selected, the handset rings only after length of ring delay selected is reached.
- Make sure that the contact under the [Set exception] option of the phonebook menu is set to [On] before you can exclude this contact from the silent mode.

Set the key tone

Key tone is the sound made when you press a key on the handset.

- 1 Select [Menu].
- 2 Press / to select , then press [OK] to confirm.
- 3 Select [Key tone], then press [OK] to confirm.
- 4 Select [On]/[Off], then press [OK] to confirm.
↳ The setting is saved.

Set the battery tone

Battery tone is the sound made when the battery is low and needs recharging.

- 1 Select [Menu].

- 2 Press / to select , then press [OK] to confirm.
- 3 Select [Battery tone], then press [OK] to confirm.
- 4 Select [On]/[Off], then press [OK] to confirm.
↳ The setting is saved.

Set the docking tone

Docking tone is the sound made when you place the handset on the base station or charger.

- 1 Select [Menu].
- 2 Press / to select , then press [OK] to confirm.
- 3 Select [Docking tone], then press [OK] to confirm.
- 4 Select [On]/[Off], then press [OK] to confirm.
↳ The setting is saved.

Set the sound profile

You can set the sound in the earpiece or handsfree mode among 3 different profiles.

- 1 Select [Menu].
- 2 Press / to select , then press [OK] to confirm.
- 3 Select [MySound], then press [OK] to confirm.
- 4 Select a profile, then press [OK] to confirm.
↳ The setting is saved.

Access the sound profile during a call

Press [Sound] for once or several times to change the sound profile during a call.

16 Baby monitor

Your phone supports the baby monitor function which sends an alert if the sound level exceeds the set limit.

! Caution

- Make sure that you do not leave the handset that has the active monitor in the baby room.
- Make sure the baby unit and the cord are always out of reach of the baby.
- Place the baby unit at least 1 meter/3 feet but not more than 2 meters/6 feet away from the baby.

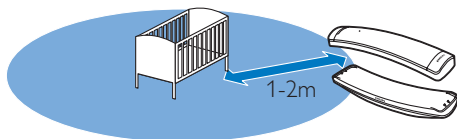

Activate/Deactivate the baby unit

- 1 Select **[Menu]**.
- 2 Press **▲** / **▼** to select **[☑]**, then press **[OK]** to confirm.
- 3 Select **[Activate]**, then press **[OK]** to confirm.
↳ The baby unit is activated. **[☑]** is displayed.

☰ Note

- Make sure that the headset is not plugged into the activated baby unit.
- When the baby monitor mode is activated, the baby unit does not ring on incoming calls.

✳ Tip

- If you have not set the parent unit, a notification message is displayed. Then you are asked to select to where you send the alert: external lines or another handset. For information, see the next section.
- To exit from the baby monitor menu, press **[Off]**.

Send an alert

You can send an alert to other handsets within the home or an external line. External line can be a cell phone or another fixed line outside the house.

☰ Note

- Make sure that any prefix digits and/or country code are included when you send an alert.

Send to other handsets

- 1 Select **[Menu]**.
- 2 Press **▲** / **▼** to select **[☑]**, then press **[OK]** to confirm.
- 3 Select **[Send alert to]** > **[Connected line]**, then press **[OK]** to confirm.
- 4 Select a handset, then press **[OK]** to confirm.

☰ Note

- Make sure that the distance between the baby unit and the parent unit is at least 1.5 meter away from each other to prevent the howling effect.

Send to an external line



- 1 Select **[Menu]**.
- 2 Press **▲** / **▼** to select **[☑]**, then press **[OK]** to confirm.

- 3 Select **[Send alert to]** > **[External line]**, then press **[OK]** to confirm.
- 4 Enter a telephone number, then press **[Save]** to confirm.



Note

- You can still send an alert to the external line even though it is in the barred list (see 'Add new number to the barred list' on page 39).

Send to a contact from the phonebook

- 1 Select **[Menu]**.
- 2 Press  /  to select , then press **[OK]** to confirm.
- 3 Select **[Send alert to]** > **[Select number]**, then press **[OK]** to confirm.
- 4 Select a contact from the phonebook, then press **[OK]** to confirm.

Set the baby cry level

- 1 Select **[Menu]**.
- 2 Press  /  to select , then press **[OK]** to confirm.
- 3 Select **[Baby cry level]**, then press **[OK]** to confirm.
- 4 Select a new setting, then press **[OK]** to confirm.
↳ The setting is saved.

17 Telephone answering machine

Note

- Available only for D605.

Your phone includes a telephone answering machine that records unanswered calls when it is on. By default, the answering machine is set to the **[Answer & rec.]** mode. You can also access the answering machine remotely and change the settings through the answering machine menu on the handset.

The LED indicator on the base station lights up when the answer machine is on.

Turn the answering machine on or off

- 1 Select **[Menu]**.
- 2 Press / to select , then press **[OK]** to confirm.
- 3 Select **[Answer mode]**, then press **[OK]** to confirm.
- 4 Select **[Answer only]/[Answer & rec.]/[Off]**, then press **[OK]** to confirm.
↳ The setting is saved.

Set the answering machine language

Note

- This feature only applies to models with multiple-language support.

The answering machine language is the language for the announcements.

- 1 Select **[Menu]**.
- 2 Press / to select , then press **[OK]** to confirm.
- 3 Select **[Voice language]**, then press **[OK]** to confirm.
- 4 Select a language, then press **[OK]** to confirm.
↳ The setting is saved.

Set the answer mode

You can set the answering machine and select if the callers can leave messages. Select **[Answer & rec.]** if you allow the callers to leave messages. Select **[Answer only]** if you forbid the callers to leave messages.

- 1 Select **[Menu]**.
- 2 Press / to select , then press **[OK]** to confirm.
- 3 Select **[Answer mode]**, then press **[OK]** to confirm.
- 4 Select an answer mode, then press **[OK]** to confirm.
↳ The setting is saved.

Note



- If the memory is full, the answering machine switches to **[Answer only]** mode automatically.

Announcements

The announcement is the message your caller hears when the answering machine picks up the call. The answering machine has 2 default announcements: the **[Answer & rec.]** mode and **[Answer only]** mode.

Record an announcement



The maximum length of the announcement you can record is 3 minutes. The newly recorded announcement automatically replaces the old one.

- 1 Select **[Menu]**.
- 2 Press  /  to select , then press **[OK]** to confirm.
- 3 Select **[Announcement]**, then press **[OK]** to confirm.
- 4 Select **[Answer & rec.]** or **[Answer only]**, then press **[OK]** to confirm.
- 5 Select **[Record new]**, then press **[OK]** to confirm.
- 6 Recording starts after the beep.
- 7 Press **[OK]** to stop recording or the recording stops after 3 minutes.
↳ You can listen to the newly recorded announcement on the handset.

Note

- Make sure that you speak close to the microphone when you record an announcement.



Listen to the announcement

- 1 Select **[Menu]**.
- 2 Press  /  to select , then press **[OK]** to confirm.
- 3 Select **[Announcement]**, then press **[OK]** to confirm.
- 4 Select **[Answer & rec.]** or **[Answer only]**, then press **[OK]** to confirm.
- 5 Select **[Play]**, then press **[OK]** to confirm.
↳ You can listen to the current announcement.

Note

- You can no longer listen to the announcement when you pick up an incoming call.

Restore the default announcement

- 1 Select **[Menu]**.
- 2 Press  /  to select , then press **[OK]** to confirm.
- 3 Select **[Announcement]**, then press **[OK]** to confirm.
- 4 Select **[Answer & rec.]** or **[Answer only]**, then press **[OK]** to confirm.
- 5 Select **[Use default]**, then press **[OK]** to confirm.
↳ The handset displays a confirmation request.
- 6 Press **[OK]** to confirm.
↳ The default announcement is restored.

Incoming messages

Each message can be up to 3 minutes long. When you receive new messages, the LED at the back of the handset flashes.

Note

- If you pick up the phone when the caller leaves a message, the recording stops and you can talk to the caller directly.

Note

- If the memory is full, the answering machine switches to **[Answer only]** automatically. Delete old messages to receive new ones.

Listen to the incoming messages

You can listen to the incoming messages in the sequence they are recorded.

- 1 Select **[Menu]**.
 - 2 Press / to select , then press **[OK]** to confirm.
 - 3 Select **[Play]**, then press **[OK]** to confirm.
 - ↳ New messages start playing. Old messages start playing if there is no new message.
- Press **[Back]** to stop listening.
 - Press **[Option]** to enter the options menu.
 - Press / to increase/decrease the volume.

Delete an incoming message

- 1 When you listen to the message, press **[Option]** to enter the options menu.
- 2 Select **[Delete]**, then press **[OK]** to confirm.
 - ↳ The current message is deleted.

Delete all old incoming messages

- 1 Select **[Menu]**.
- 2 Press / to select , then press **[OK]** to confirm.
- 3 Select **[Delete all]**, then press **[OK]** to confirm.
 - ↳ A confirmation request is displayed on the handset.
- 4 Press **[OK]** to confirm.
 - ↳ All old messages are permanently deleted.

Note

- You can only delete the read messages. No deleted messages can be recovered.

Set the sound quality of the message

You can adjust the sound quality of the messages received from the answering machine.

- 1 Select **[Menu]**.
- 2 Press / to select , then press **[OK]** to confirm.
- 3 Select **[Msg quality]**, then press **[OK]** to confirm.
- 4 Select the new setting, then press **[OK]** to confirm.
 - ↳ The setting is saved.

Note

- The sound quality can only be adjusted before recording starts.

Set the ring delay

You can set the number of times the phone rings before the call goes to the answering machine..

- 1 Select **[Menu]**.
- 2 Press / to select , then press **[OK]** to confirm.
- 3 Select **[Ring delay]**, then press **[OK]** to confirm.
- 4 Select a new setting, then press **[OK]** to confirm.
 - ↳ The setting is saved.

Note

- Make sure that the answering machine is switched on before this feature can be applied.



Tip

- When you access the answering machine remotely, you are recommended to set the ring delay to **[Toll saver]** mode. This is a cost effective way to manage your messages. When there are new messages, the answering machine picks up the call after 3 rings; When there is no messages, it picks up the call after 5 rings.

Remote access

You can operate your answering machine when you are away from home. Simply make a call to your phone with a touch tone phone and enter your 4-digit PIN/passcode.



Note

- The remote access PIN/passcode is the same as your system PIN/passcode. The preset PIN/passcode is 0000.

Change the PIN/passcode

- 1 Select **[Menu]**.
- 2 Press / to select , then press **[OK]** to confirm.
- 3 Select **[Remote access]** > **[Change PIN]**, then press **[OK]** to confirm.
- 4 Enter the old PIN/passcode, then press **[OK]** to confirm.
- 5 Enter the new PIN/passcode, then press **[OK]** to confirm.
- 6 Enter the new PIN/passcode again, then press **[Save]** to confirm.
↳ The setting is saved.

Activate/deactivate the remote access

You can allow or block remote access to the answering machine.

- 1 Select **[Menu]**.
- 2 Press / to select , then press **[OK]** to confirm.
- 3 Select **[Remote access]**, then press **[OK]** to confirm.
- 4 Select **[Activate]** / **[Deactivate]**, then press **[OK]** to confirm.

↳ The setting is saved.

Access the answering machine remotely

- 1 Make a call to your home number with a touch tone phone.
- 2 Enter **#** when you hear the announcement.
- 3 Enter your PIN/passcode.
↳ You now have access to your answering machine, and you can listen to the new messages.



Note

- You have 2 chances to enter the correct PIN/passcode before your phone hangs up.

- 4 Press a key to carry out a function. See the Remote access commands table below for a list of available functions.



Note

- When there is no message, the phone hangs up automatically if no key is pressed for 8 seconds.

Remote access commands

Key	Function
1	Repeat the current or listen to the previous message.
2	Listen to messages.
3	Skip to the next message.
6	Delete the current message.
7	Switch the answering machine on. (not available when you listen to the messages).
8	Stop listening to the message.
9	Switch the answering machine off. (not available when you listen to the messages).

18 Services

The phone supports a number of features that help you handle and manage the calls.



Auto conference

To join an external call with another handset, press .

Note

- This feature is available only for multi-handset versions.



Activate/Deactivate auto conference

- 1 Select **[Menu]**.
- 2 Press  /  to select , then press **[OK]** to confirm.
- 3 Select **[Conference]**, then press **[OK]** to confirm.
- 4 Select **[Auto]/[Off]**, then press **[OK]** to confirm.
↳ The setting is saved.

Call barring



You can block outgoing calls to numbers, such as overseas calls or undesirable hotlines by barring calls that start with certain digits. You can create 4 sets of numbers with 4 digits at maximum for each set of numbers. When you make a call that starts with one of these 4 sets of numbers, the outgoing call is then barred.

Select the barring mode

- 1 Select **[Menu]**.
- 2 Press  /  to select , then press **[OK]** to confirm.

- 3 Select **[Call barring]** > **[Barring mode]** then press **[OK]** to confirm.
- 4 Enter the PIN/passcode. The default PIN/passcode is 0000.
- 5 Select **[On]/[Off]**, then press **[OK]** to confirm.
↳ The setting is saved.



Add new number to the barred list

- 1 Select **[Menu]**.
- 2 Press  /  to select , then press **[OK]** to confirm.
- 3 Select **[Call barring]** > **[Barring number]**, then press **[OK]** to confirm.
- 4 Enter the PIN/passcode. The default PIN is 0000.
- 5 Select a number from the list, then press **[OK]** to confirm.
- 6 Edit the number; then press **[OK]** to confirm.
↳ The setting is saved.

Note

- The number in the barred list can still be sent as an external line for a baby call (see 'Send to an external line' on page 32).

Change the PIN/passcode

- 1 Select **[Menu]**.
- 2 Press  /  to select , then press **[OK]** to confirm.
- 3 Select **[Call barring]** > **[Change PIN]**, then press **[OK]** to confirm.
- 4 Enter the old PIN/passcode, then press **[OK]** to confirm.
- 5 Enter the new PIN/passcode, then press **[OK]** to confirm.
- 6 Enter the new PIN/passcode again, then press **[Save]** to confirm.

↳ The setting is saved.

Note

- If you forget the PIN/passcode, you have to reset your phone (see 'Restore default settings' on page 42).

Call list type

You can set if you can see all calls or missed calls from the call log.

Select the call list type

- 1 Select **[Menu]**.
- 2 Press / to select , then press **[OK]** to confirm.
- 3 Select **[Call list type]**, then press **[OK]** to confirm.
- 4 Select an option, then press **[OK]** to confirm.

Auto prefix

This feature checks and formats your outgoing call number before it is dialed out. The prefix number can replace the detect number you set in the menu. For example, you set 604 as the detect number and 1250 as the prefix. When you have dialed out a number such as 6043338888, your phone changes the number to 12503338888 when it dials out.

Note

- The maximum length of a detect number is 5 digits. The maximum length of an auto prefix number is 10 digits.

Set auto prefix

- 1 Select **[Menu]**.

- 2 Press / to select , then press **[OK]** to confirm.
- 3 Select **[Auto prefix]**, then press **[OK]** to confirm.
- 4 Enter the detect number, then press **[OK]** to confirm.
- 5 Enter the prefix number, then press **[OK]** to confirm.
↳ The setting is saved.

Note

- This is a country dependent feature.
- To enter a pause, press and hold **#327A**.
- If the prefix number is set and the detect number is left empty, the prefix number is added to all outgoing calls.
- The feature is unavailable if the dialed number starts with * and #.

Network type

Note

- This is a country dependent feature. It only applies to models with network type support.

- 1 Select **[Menu]**.
- 2 Press / to select , then press **[OK]** to confirm.
- 3 Select **[Network type]**, then press **[OK]**.
- 4 Select a network type, then press **[OK]**.
↳ The setting is saved.

Select the recall duration

Make sure that the recall time is set correctly before you can answer a second call. In normal case, the phone is already preset for the recall duration. You can select among 3 options: **[Short]**, **[Medium]** and **[Long]**. The number of available options varies with different countries. For details, consult your service provider.

- 1 Select **[Menu]**.
- 2 Press / to select , then press **[OK]** to confirm.
- 3 Select **[Recall time]**, then press **[OK]** to confirm.
- 4 Select an option, then press **[OK]** to confirm.
↳ The setting is saved.

Dial mode

Note

- This feature is country dependent and only applies to models that support both tone and pulse dial.

Dial mode is the telephone signal used in your country. The phone supports tone (DTMF) and pulse (rotary) dial. Consult the service provider for detailed information.

- 1 Select **[Menu]**.
- 2 Press / to select , then press **[OK]** to confirm.
- 3 Select **[Dial mode]**, then press **[OK]** to confirm.
- 4 Select an option, then press **[OK]** to confirm.
↳ The setting is saved.

First ring

If you have subscribed to the caller ID service with your service provider, your phone can cancel the first ring before the caller ID is displayed on the screen. After the phone is reset, it can detect automatically if there is a caller subscription and start to cancel the first ring. You can change this setting to suit your preference. This feature only applies to models with first ring support.

Turn the first ring on/off

- 1 Select **[Menu]**.
- 2 Press / to select , then press **[OK]** to confirm.
- 3 Select **[First ring]**, then press **[OK]** to confirm.
- 4 Select **[On]/[Off]**, press **[OK]** to confirm.
↳ The setting is saved.

Note

- To reset the first ring status, go to the reset menu.

Auto clock

Note

- This service is network dependent.
- Make sure you have subscribed to the caller ID service before you use this feature.

It synchronizes the date and time on your phone with the public switched telephone network (PSTN) automatically. For the date to be synchronized, make sure the current year is set.

- 1 Select **[Menu]**.
- 2 Press / to select , then press **[OK]** to confirm.
- 3 Select **[Auto clock]**, then press **[OK]** to confirm.
- 4 Select **[On]/[Off]**, then press **[OK]** to confirm.
↳ The setting is saved.

Register additional handsets

You can register additional handsets to the base station. The base station can register up to 4 handsets.

Auto registration

Extra handsets of the same model can be auto-registered. Place the unregistered handset on the base station.

- ↳ The handset detects the base station and registers automatically.
- ↳ Registration is complete in less than two minutes. The base station automatically assigns a handset number to the handset.

Manual registration/Pairing

If auto registration fails or if you register a handset of a different model, register your handset manually to the base station.

- 1 Select **[Menu]**.
- 2 Press / to select , then press **[OK]** to confirm.
- 3 Select **[Register]**, then press **[OK]** to confirm.
- 4 Press and hold **(•)** on the base station for 5 seconds.
- 5 Enter the system PIN/passcode. Press **[Clear]** to make corrections.
- 6 Press **[OK]** to confirm the PIN/passcode.
 - ↳ Registration is complete in less than 2 minutes.



Note

- If the PIN/passcode is incorrect or no base is found within a certain period, your handset displays a notification message. Repeat the above procedure if registration fails.
- The preset PIN/passcode is 0000. No change can be made on it.

Unregister handsets

- 1 If two handsets share the same base station, you can unregister a handset with another handset.
- 2 Select **[Menu]**.
- 3 Press / to select , then press **[OK]** to confirm.
- 4 Select **[Unregister]**, then press **[OK]** to confirm.
- 5 Select the handset to be unregistered.
- 6 Press **[OK]** to confirm.
 - ↳ The handset is unregistered.

Restore default settings

You can reset your phone settings to the original factory settings.

- 1 Select **[Menu]**.
- 2 Press / to select , then press **[OK]** to confirm.
- 3 Select **[Reset]**, then press **[OK]** to confirm.
 - ↳ A confirmation request is displayed on the handset.
- 4 Press **[OK]** to confirm.
 - ↳ All settings are reset.

19 Technical data

General specification and features

- Talk time: 18 hours
- Standby time: 250 hours
- Range indoor: 50 meters
- Range outdoor: 300 meters
- Phonebook list with 250 entries
- Redial list with 20 entries
- Call log with 50 entries
- Answering machine with up to 60 minutes recording time
- Caller identification standard support: FSK, DTMF

Battery

- Philips: 2 × AAA Ni-MH 1.2V 550 mAh rechargeable batteries

Power adapter

Base and charger

- MEIC, MN-A075-U056, input: 100-240V~, 50-60Hz 200mA, output: (i) 6.5V 300 mA, (ii) 7.5V 200 mA

Power consumption

- Power consumption in idle mode: around 0.7 W

Weight and dimensions

- Handset: 168.6 grams
- 33.25 × 210 × 46.45 mm (H × W × D)
- Base: 136.6 grams
- 30.3 × 210 × 46.45 mm (H × W × D)

20 Notice

Declaration of conformity

Hereby Philips Consumer Lifestyle, declares that the M888 is in compliance with the essential requirements and other relevant provisions of Directive 1999/5/EC. You can find the Declaration of Conformity on www.p4c.philips.com.

This product has been designed, tested and manufactured according the European R&TTE directive 1999/5/EC.

Use GAP standard compliance

The GAP standard guarantees that all DECT™ GAP handsets and base stations comply with a minimum operating standard irrespective of their make. The handset and base station are GAP compliant, which means they guarantee the minimum functions: register a handset, take the line, make a call and receive a call. The advanced features may not be available if you use them with other makes. To register and use this handset with a GAP compliant base station of different make, first follow the procedure described in the manufacturer's instructions, then follow the procedure described in this manual for registering a handset. To register a handset from different make to the base station, put the base station in registration mode, then follow the procedure described in the handset manufacturer's instructions.

Compliance with EMF

Koninklijke Philips Electronics N.V. manufactures and sells many products targeted at consumers, which, like any electronic apparatus, in

general have the ability to emit and receive electromagnetic signals.

One of Philips' leading Business Principles is to take all necessary health and safety measures for our products, to comply with all applicable legal requirements and to stay well within the EMF standards applicable at the time of producing the products.

Philips is committed to develop, produce and market products that cause no adverse health effects. Philips confirms that if its products are handled properly for their intended use, they are safe to use according to scientific evidence available today.

Philips plays an active role in the development of international EMF and safety standards, enabling Philips to anticipate further developments in standardization for early integration in its products.

Disposal of your old product and batteries



Your product is designed and manufactured with high quality materials and components, which can be recycled and reused.



When this crossed-out wheeled bin symbol is attached to a product it means that the product is covered by the European Directive 2002/96/EC. Please inform yourself about the local separate collection system for electrical and electronic products.

Please act according to your local rules and do not dispose of your old products with your normal household waste.

Correct disposal of your old product helps to prevent potential negative consequences for the environment and human health.



Your product contains batteries covered by the European Directive 2006/66/EC, which cannot be disposed with normal household waste. Please inform yourself about the local rules on separate collection of batteries because correct disposal helps to prevent negative consequences for the environmental and human health.



When this logo is attached to a product, it means a financial contribution has been paid to the associated national recovery and recycling system.

Environmental information

All unnecessary packaging has been omitted. We have tried to make the packaging easy to separate into three materials: cardboard (box), polystyrene foam (buffer) and polyethylene (bags, protective foam sheet.)

Your system consists of materials which can be recycled and reused if disassembled by a specialized company. Please observe the local regulations regarding the disposal of packaging materials, exhausted batteries and old equipment.

21 Frequently asked questions

No signal bar is displayed on the screen.

- The handset is out of range. Move it closer to the base station.
- If the handset displays **[Register your Handset]**, put the handset on the base until the signal bar appears.

Tip

- For further information, see 'Register additional handsets' on the Services section.





My handset is in searching status, what do I do?

- Make sure that the base station has power supply.
- Register the handset to the base station.
- Move the handset closer to the base station.

If I fail to pair (register) additional handsets to the base station, what do I do?

Your base memory is full. Unregister the unused handsets and try again.

I have chosen a wrong language which I cannot read, what do I do?

- 1 Press  to go back to the standby screen.
- 2 Press  to access the main menu screen.
- 3 Press  /  to select , then you see one of the following texts appear on the screen:

語言

Language

- 4 Select it to access the language options.
- 5 Select your own language.

No dialing tone

- Check your phone connections.
- The handset is out of range. Move it closer to the base station.

No docking tone

- The handset is not placed properly on the base station/charger.
- The charging contacts are dirty. Disconnect the power supply first and clean the contacts with a damp cloth.

I cannot change the settings of my voice mail, what do I do?

The voice mail service is managed by your service provider but not the phone itself. Contact your service provider to change the settings.

The handset on the charger does not charge.

- Make sure the batteries are inserted correctly.
- Make sure the handset is placed properly on the charger. The LED at the back of the handset flashes once when charging.
- Make sure the docking tone setting is turned on. When the handset is placed correctly on the charger, you can hear a docking tone.
- The charging contacts are dirty. Disconnect the power supply first and clean the contacts with a damp cloth.
- Batteries are defective. Purchase new ones with the same specifications. To remove the battery door, refer to the instruction in the following picture.

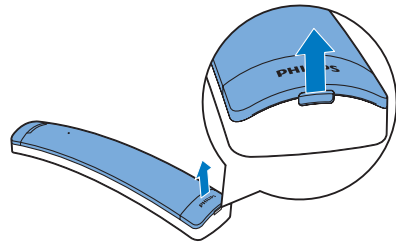

No display

- Make sure the batteries are charged.
- Make sure there is power and the phone is connected.

Bad audio (crackles, echo, etc.)

- The handset is nearly out of range. Move it closer to the base station.

- The phone receives interference from the nearby electrical appliances. Move the base station away from them.
- The phone is at a location with thick walls. Move the base away from them.

The handset does not ring.

Make sure the handset ringtone is turned on.

The caller ID does not display.

- The service is not activated. Check with your service provider.
- The caller's information is withheld or unavailable.



Note

- If the above solutions do not help, disconnect the power supply from both the handset and base station. Try again after 1 minute.

22 Appendix

Text and number input tables

Key	Upper case characters (for English/ French/ German/ Italian/Turkish/ Portuguese/Spanish/Dutch/Danish/ Finnish/Norwegian/ Swedish/Romanian/ Polish/Czech/Hungarian/Slovakian/ Slovenian/Croatian/Lithuanian/Estonian/ Latvian/Bulgarian)
0	Space . 0 , / ; " ' ! ; ? ; * + - % \ ^ ~
1	1 @ _ # = < > () & € £ \$ ¥ [] { } □ § ...
2	A B C 2 À Á Â Ã Ä Å Æ Ç Ć
3	D E F 3 È É Ê Ë Ì Í Î Ï Δ Φ
4	G H I 4 Ğ Ĩ Ĵ Ķ Ļ Γ
5	J K L 5 Λ
6	M N O 6 Ñ Ó Ô Õ Ö
7	P Q R S 7 Š Ś Π Θ Σ
8	T U V 8 Ù Ú Û Ü Ů
9	W X Y Z 9 Ø Ω Ξ Ψ Ž

Key	Lower case characters (for English/ French/ German/ Italian/Turkish/ Portuguese/Spanish/Dutch/Danish/ Finnish/Norwegian/Swedish)
0	Space . 0 , / ; " ' ! ; ? ; * + - % \ ^ ~
1	1 @ _ # = < > () & € £ \$ ¥ [] { } □ § ...
2	a b c 2 à á â ã ä å æ ç ĉ
3	d e f 3 è é ê ë è ē ē Δ Φ
4	g h i 4 ğ ħ ĵ ĳ Ķ Ļ Γ
5	j k l 5 λ
6	m n o 6 ñ ó ô õ ö ò
7	p q r s 7 š ś π θ σ
8	t u v 8 ù ú û ü ů
9	w x y z 9 ø ω ξ ψ ž



CE 0168

Specifications are subject to change without notice
© 2013 Koninklijke Philips Electronics N.V.
All rights reserved.

UM_M888_90_EN_V1.0
WK1329

