

Register your product and get support at
www.philips.com/welcome

HTS6520



EN	User manual	3
MS-MY	Manual pengguna	3
ZH-TW	使用手冊	3
ZH-CN	用户手册	3

PHILIPS

Contents

1 Important	4
Safety and important notice	4
Trademark notice	5
2 Your Home Theater System	6
Feature highlights	6
Product overview	7
3 Connect	10
Place the Home Theater System	10
Connect video cables	11
Connect speakers and subwoofer	13
Connect radio antenna	13
Connect audio cables/other devices	14
Connect power cord	17
Attach table stand	17
Mount the Home Theater System	18
Mount the speakers	19
4 Get started	20
Insert the remote control batteries	20
Find the correct viewing channel	21
Select menu display language	21
Start Ambisound setup	22
Turn on Progressive Scan	23
Use Philips EasyLink	23
Select a play source	25
5 Play	26
Play a disc	26
Play video	26
Play music	29
Play photo	30
Play from USB device	31
Play from portable media player	32
Play from iPod	32
Play from radio	33
6 Adjust sound	35
Control the volume	35
Adjust Bass/Treble	35
Select Ambisound	35
Select a preset sound	35
7 Adjust settings	36
General setup	36
Audio setup	38
Video setup	39
Preferences	40
8 Additional Information	43
Update software	43
Care	43
9 Specifications	44
10 Troubleshooting	46
11 Glossary	48

1 Important

Safety and important notice



Warning

- Risk of overheating! Never install the product in a confined space. Always leave a space of at least 4 inches around the product for ventilation. Ensure curtains or other objects never cover the ventilation slots on the product.
- Never place the product, remote control or batteries near naked flames or other heat sources, including direct sunlight.
- Only use this product indoors. Keep this product away from water, moisture and liquid-filled objects.
- Never place this product on other electrical equipment.
- Keep away from this product during lightning storms.
- Where the mains plug or an appliance coupler is used as the disconnect device, the disconnect device shall remain readily operable.
- Visible and invisible laser radiation when open. Avoid exposure to beam.

Recycle notice



This electronic equipment contains a large number of materials that can be recycled or reused if disassembled by a specialized company. If you are disposing of an old machine, please take it to a recycling center. Please observe the local regulations regarding disposal of packaging materials, exhausted batteries and old equipment.

Copyright notice



Be responsible
Respect copyrights

This product incorporates copyright protection technology that is protected by method claims of certain U.S. patents and other intellectual property rights owned by Macrovision Corporation and other rights owners. Use of this copyright protection technology must be authorised by Macrovision Corporation, and is intended for home and other limited viewing uses only unless otherwise authorised by Macrovision Corporation. Reverse engineering or disassembly is prohibited.

About Progressive Scan

Consumers should note that not all high definition television sets are fully compatible with this product and may cause artifacts to be displayed in the picture. In case of 525 or 625 progressive scan picture problems, it is recommended that the user switch the connection to the 'standard definition' output. If there are questions regarding our TV set compatibility with this model 525p and 625p DVD player, please contact our customer service center.

Trademark notice



Manufactured under license from Dolby Laboratories. Dolby, Pro Logic and the double-D symbol are trademarks of Dolby Laboratories.



DivX, DivX Ultra Certified, and associated logos are trademarks of DivX, Inc. and are used under license.

Official DivX® Ultra Certified product. Plays all versions of DivX® video (including DivX® 6) with enhanced playback of DivX® media files and the DivX® Media Format. Plays DivX® video with menus, subtitles and audio tracks.



Manufactured under license under U.S. Patent #'s: 5,451,942; 5,956,674; 5,974,380; 5,978,762; 6,487,535 & other U.S. and worldwide patents issued & pending. DTS and DTS Digital Surround are registered trademarks and the DTS logos and Symbol are trademarks of DTS, Inc. © 1996-2008 DTS, Inc. All Rights Reserved.



Windows Media and the Windows logo are trademarks, or registered trademarks of Microsoft Corporation in the United States and/or other countries.



HDMI, and HDMI logo and High-Definition Multimedia Interface are trademarks or registered trademarks of HDMI licensing LLC.



The USB-IF Logos are trademarks of Universal Serial Bus Implementers Forum, inc.



iPod is a trademark of Apple Computer, Inc., registered in the U.S. and other countries.



ENERGY STAR and the ENERGY STAR mark are registered U.S. marks.



2 Your Home Theater System

Congratulations on your purchase, and welcome to Philips! To fully benefit from the support that Philips offers, register your product at www.philips.com/welcome.

Feature highlights

Philips EasyLink

Your Home Theater System supports Philips EasyLink, which uses the HDMI CEC (Consumer Electronics Control) protocol. EasyLink-compliant devices that are connected through HDMI connectors can be controlled by a single remote control.

 **Note**

- Philips does not guarantee 100% interoperability with all HDMI CEC devices.

Philips Ambisound

Philips Ambisound technology reproduces multi-channel surround sound with fewer speakers to give an embracing surround experience without the hassle of setting up a full range of speaker systems.

Video upscaling to 1080p

Enjoy watching discs in the highest picture quality available for your HDTV. This Home Theater System offers full high-definition video playback up to 1080p resolution that provides a highly detailed picture and increased sharpness that delivers a more true-to-life picture for an amazing viewing experience.

Hi speed USB 2.0 Link and MP3 link



Simply plug your USB device into the USB jack to play your MP3/WMA/JPEG/DivX files; or plug your portable media player to the MP3 LINK jack to enjoy the music play in superb sound quality.

Sync the audio output with the video play

Synchronize audio and video by delaying the audio output if the video signal sent to the TV is slower than the audio streams.

Region codes

You can play discs with the following region codes.

DVD region code	Countries
	Asia Pacific, Taiwan, Korea
	Australia, New Zealand
	China

Product overview

Main unit

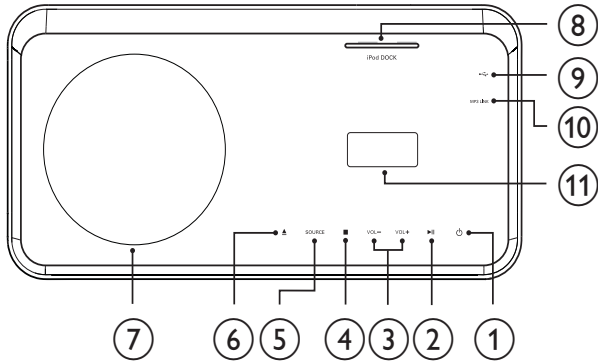

- ① **⏻ (Standby-On)**
 - Turns on the Home Theater System or switches to standby mode.
- ② **▶⏸ (Play/Pause)**
 - Starts, pauses or resumes disc play.
 - In radio mode, automatically tunes radio stations during first-time setup.
- ③ **VOL +/-**
 - Increases or decreases volume.
- ④ **■ (Stop)**
 - Stops disc play.
 - In radio mode, erases the current preset radio station.
- ⑤ **SOURCE**
 - Selects a media to play or listen to audio from the connected device.
- ⑥ **▲ (Open/Close)**
 - Opens or closes the disc compartment.
- ⑦ **Disc compartment**
- ⑧ **iPod DOCK**
 - Docks a iPod.
- ⑨ **USB**
 - Connects a USB supported device.









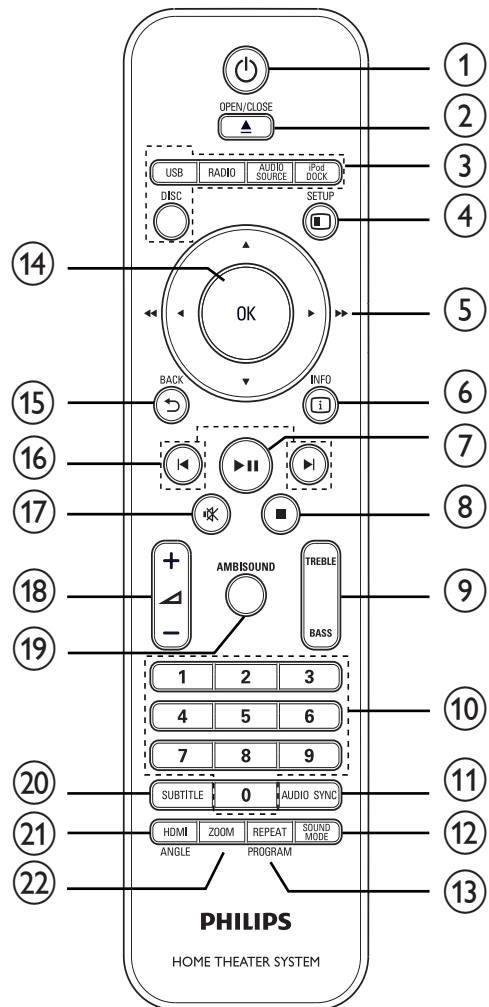





- ⑩ **MP3 LINK**
 - Connects a portable audio player
- ⑪ **Display panel**

Note

- Control buttons on this Home Theater System are operated through touch screen display. The control displays will be dimly lit after one second of inactivity.
- You can change the brightness of the touch screen display (see 'Adjust settings' > 'General Setup' > [Display Dim]).

Remote control



- ①  **(Standby-On)**
 - Turns on the Home Theater System or switches to standby mode.
 - When EasyLink is enabled, switches the Home Theater System and all EasyLink devices to standby. Note that you must press and hold  **(Standby-On)** for at least 3 seconds for this to occur.
- ②  **OPEN/CLOSE**
 - Opens or closes the disc compartment.
- ③ **Source buttons**
 - **DISC:** Switches to the disc source.
 - **USB:** Switches to the USB source.
 - **RADIO:** Switches to FM band.
 - **AUDIO SOURCE:** Selects an audio input source.
 - **iPod DOCK:** Switches to the iPod in the dock.
- ④  **SETUP**
 - Accesses or exits the setup menu.
- ⑤  **(Navigation buttons)**
 - Navigates through the menus.
 - Press left and right for fast backward or forward search.
 - In radio mode, press up and down to tune the radio frequency.
 - In radio mode, press left or right to start auto search.
- ⑥  **INFO**
 - For discs, displays information about the current status or the disc.
 - For slideshows, displays a thumbnail view of photo files.
- ⑦  **(Play/Pause)**
 - Starts, pauses or resumes disc play.
 - In radio mode, automatically tunes radio stations during first-time setup.
- ⑧  **(Stop)**
 - Stops disc play.
 - In radio mode, erases the current preset radio station.
- ⑨ **TREBLE / BASS**
 - Selects Treble or Bass mode, then press  **+/-** to set the level for treble or bass output.
- ⑩ **Numeric buttons**
 - Selects an item to play.
- ⑪ **AUDIO SYNC**
 - Selects an audio language or channel on a disc.
 - Press and hold to access the setting for audio sync, then press  **+/-** to set the audio delay time.
 - In radio mode, toggles between FM stereo and FM mono.
- ⑫ **SOUND MODE**
 - Selects a predefined sound effect.
- ⑬ **REPEAT / PROGRAM**
 - Selects or turns off repeat or shuffle mode.
 - In radio mode, resets the list of preset stations: press to manually reset; press and hold to automatically reset.
- ⑭ **OK**
 - Confirms an entry or selection.
- ⑮  **BACK**
 - Returns to a previous screen.
 - For DVD, goes to the title menu.
 - For VCD version 2.0 or SVCD with PBC turned on, returns to the menu during playback.
- ⑯  **(Previous/Next)**
 - Skips to the previous or next title, chapter, or track.
- ⑰  **(Mute)**
 - Mutes or restores audio output.
- ⑱  **+/-**
 - Increases or decreases volume.
- ⑲ **AMBISOUND**
 - Selects stereo sound output or multi-channel surround output.

⑳ SUBTITLE

- Selects the subtitle language on a disc.

㉑ HDMI / ANGLE

- Selects the video resolution of HDMI output.
- Press and hold to display video from different camera angles.

㉒ ZOOM

- Zooms in or out of the picture.

3 Connect

Make the following connections to use your Home Theater System.

Basic connections:

- Video
- Speakers and subwoofer
- Power

Optional connections:

- Radio antenna
- Audio
 - Audio from TV
 - Audio from cable box/recorder/ game console
- Other devices
 - Portable media player
 - USB device
 - iPod
- Attach table stand
- Mount the Home Theater System
- Mount the speakers



Note

- Refer to the type plate at the back or bottom of the product for identification and supply ratings.
- Before you make or change any connections, ensure that all the devices are disconnected from the power outlet.



Tip

- Different types of connectors may be used to connect this product to your TV, depending on availability and your needs. A comprehensive interactive guide to help you connect your product is available at www.connectivityguide.philips.com.

Place the Home Theater System

- Place the Home Theater System where it cannot be pushed, pulled over or knocked down. Do not place it in an enclosed cabinet.
- Be sure that you have full access to the power cord for easy disconnection of the Home Theater System from the power supply.

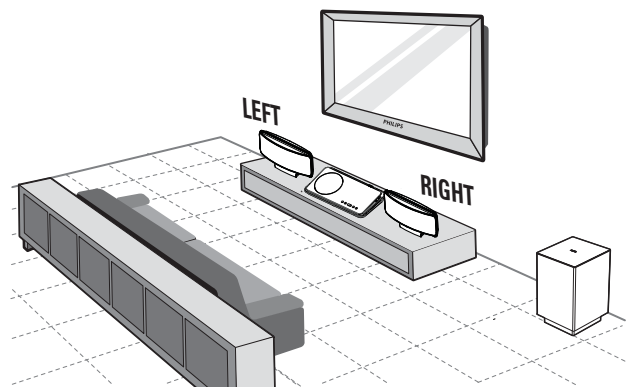

- 1 Place this Home Theater System near the TV.
- 2 Place the speakers system at normal listening ear-level and directly parallel to the listening area.
- 3 Place the subwoofer at the corner of the room or at least 3 feet away from the TV.



Tip

- To avoid magnetic interference or unwanted noise, never place this Home Theater System too close to any radiation devices.



Note

- Attach the table stand to this Home Theater System before place it on a table top. (see 'Attach table stand' on page 17)
- You can mount this Home Theater System (see 'Mount the Home Theater System' on page 18).

Connect video cables

Connect this Home Theater System to TV to view disc play. Select the best video connection that the TV can support.

- Option 1: Connect to the HDMI jack (for a HDMI, DVI or HDCP-compliant TV).
- Option 2: Connect to the component video jacks (for a standard TV or Progressive Scan TV).
- Option 3: Connect to the video (CVBS) jack (for a standard TV).

Note

- You must connect this Home Theater System directly to a TV.

Before you connect

- 1 Push up the catch and remove the rear cover.

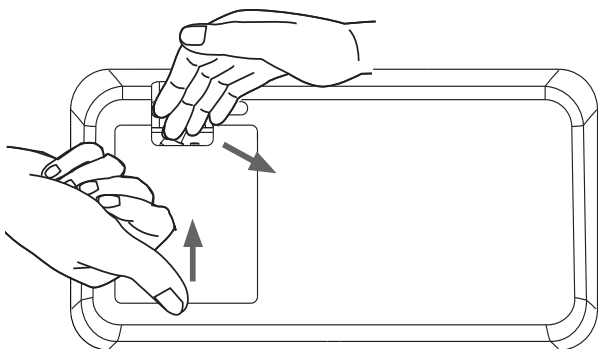

- 2 Connect the cables to the corresponding jacks and direct the cables to the open hole on top.
 - See the connection options in the following pages.
- 3 Once complete, close the rear cover.

Note

- All the cables must be placed inside the rear panel in order to close the rear cover properly.

Option 1: Connect to the HDMI jack

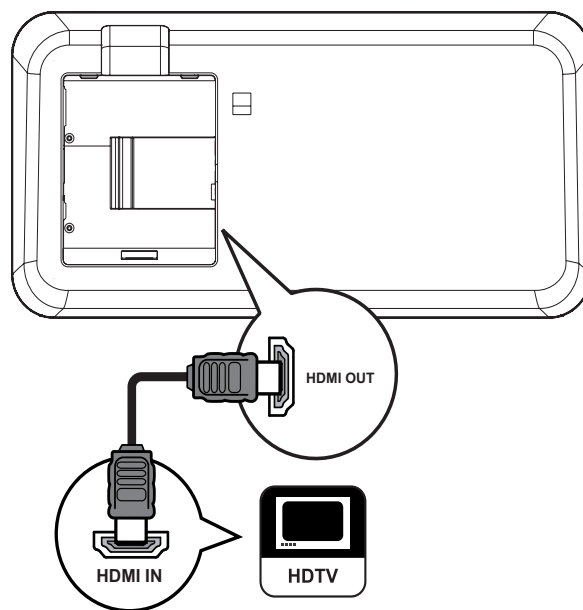

- 1 Connect an HDMI cable (not supplied) to the **HDMI OUT** jack on this Home Theater System and the HDMI input jack on the TV.

Note

- If your device supports HDMI CEC, you can control compliant devices with a single remote control. (see 'Get started' > 'Use Philips EasyLink').

Tip

- If the TV has a DVI connection only, connect via a HDMI/DVI adaptor. Connect an audio cable for sound output.
- You can optimize the video output. (see 'Adjust settings' > 'Video setup' > **[HDMI Setup]**).
- This type of connection provides the best picture quality.

Option 2: Connect to the component video jack

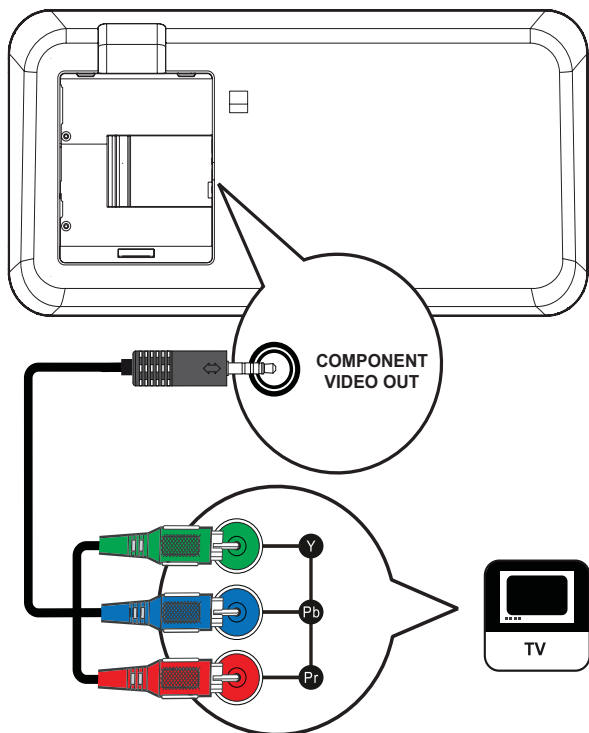

- 1 Connect the component video cable to the **COMPONENT VIDEO OUT** jack on this Home Theater System and the **COMPONENT VIDEO** input jack on the TV.
 - If a progressive scan TV is used, you may turn on the progressive scan mode.

Note

- The component video input jack on the TV might be labeled as Y Pb/Cb Pr/Cr or YUV.
- This type of connection provides good picture quality.

Option 3: Connect to the Video (CVBS) jack

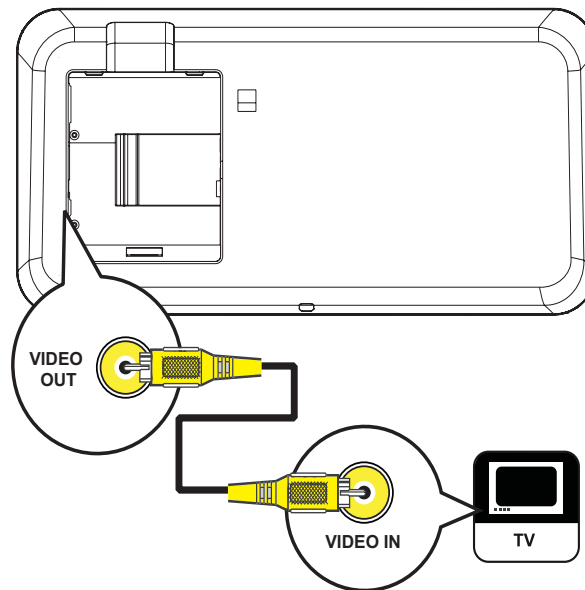

- 1 Connect a composite video cable to the **VIDEO OUT** jack on this Home Theater System and the **VIDEO** input jack on the TV.

Note

- The video input jack on the TV might be labeled as A/V IN, VIDEO IN, COMPOSITE or BASEBAND.
- This type of connection provides standard picture quality.

Connect speakers and subwoofer

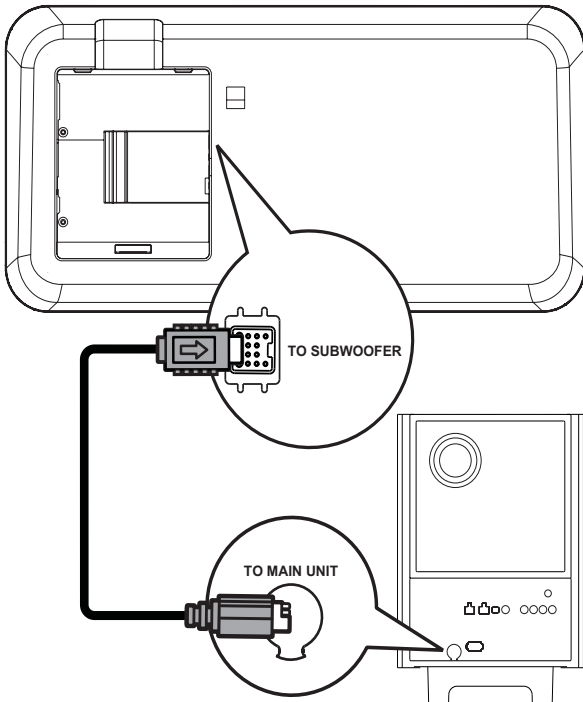
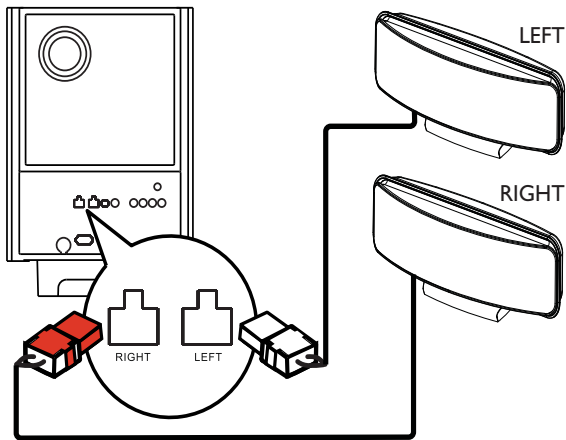

- 1 Connect the left and right speakers to the matching jacks on the subwoofer.
- 2 Unwind the subwoofer's interconnect cable at **TO MAIN UNIT** and connect it to the **TO SUBWOOFER** jack on this Home Theater System.

Note

- Ensure that the front portion of the plug is fully inserted into the jack.

Connect radio antenna

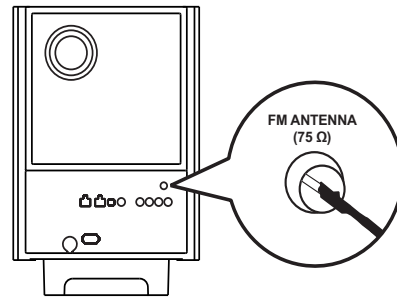

- 1 Connect the FM antenna to the **FM75 Ω** jack on the subwoofer (for some models, this cable is already connected).
- 2 Extend the FM antenna and fix its ends to the wall.

Tip

- For better FM stereo reception, connect to an external FM antenna.

Connect audio cables/other devices

Route the audio from other devices to this Home Theater System to enjoy audio play with multi-channel surround capabilities.

Connect audio from TV

(also used for EasyLink control)

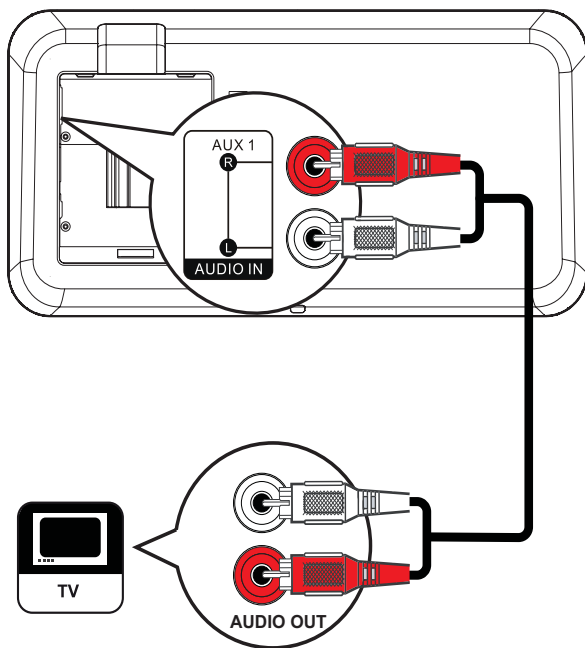

- 1 Connect the audio cables (not supplied) to the **AUDIO IN-AUX1** jacks on the Home Theater System and the AUDIO output jacks on the TV.

Note

- To listen to the audio output from this connection, press **AUDIO SOURCE** repeatedly until 'AUX1 INPUT' is displayed on the display panel.

Connect audio from cable box/ recorder/game console

You can choose to connect to analog or digital jack depending on the device capabilities.

Connect to analog jacks

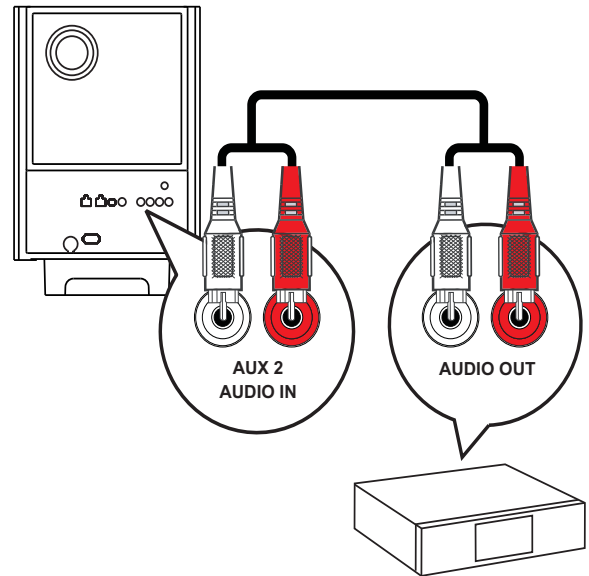

- 1 Connect the audio cables (not supplied) to the **AUDIO IN-AUX2** or **AUX3** jacks on the subwoofer and the AUDIO output jacks on the device.

Note

- To listen to the audio output from this connection, press **AUDIO SOURCE** repeatedly until 'AUX2 INPUT' or 'AUX3 INPUT' is displayed on the display panel.

Connect to coaxial jack

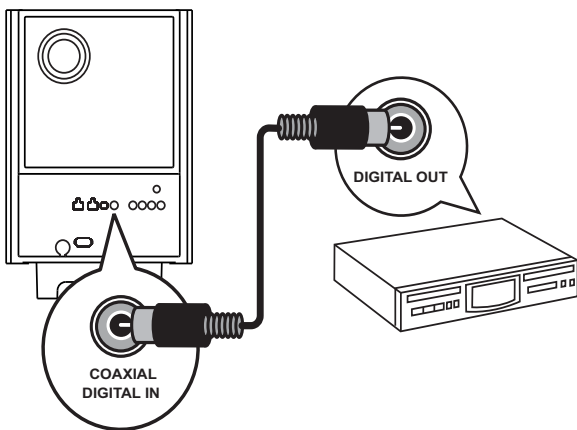

- 1 Connect a coaxial cable (not supplied) to the **COAXIAL DIGITAL-IN** jack on the subwoofer and the COAXIAL/DIGITAL output jack on the device.

Note

- To listen to the audio output from this connection, press **AUDIO SOURCE** repeatedly until 'COAXIAL INPUT' is displayed on the display panel.

Connect to optical jack

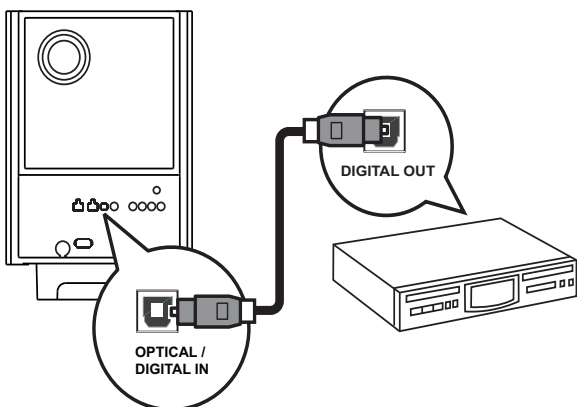

- 1 Connect an optical cable (not supplied) to the **OPTICAL DIGITAL-IN** jack on the subwoofer and the OPTICAL/SPDIF output jack on the device.

Note

- To listen to the audio output from this connection, press **AUDIO SOURCE** repeatedly until 'OPTICAL INPUT' is displayed on the display panel.

Connect portable media player

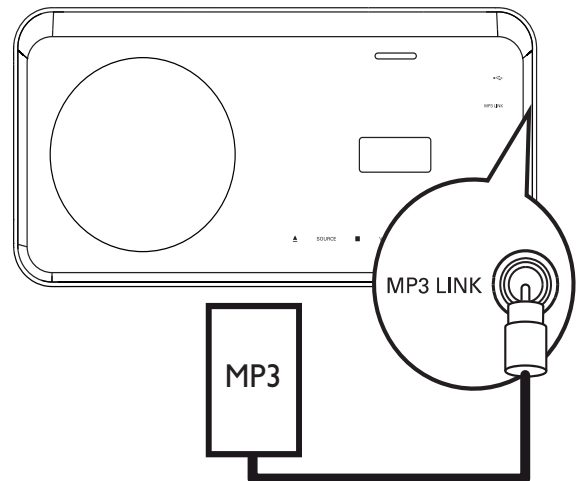

- 1 Connect a 3.5mm stereo audio cable (not supplied) to the **MP3 LINK** jack on this Home Theater System and the phone jack on the portable media player (such as MP3 player).

Note

- To listen to the audio output from this connection, press **AUDIO SOURCE** repeatedly until 'MP3 LINK' is displayed on the display panel.

Connect USB device

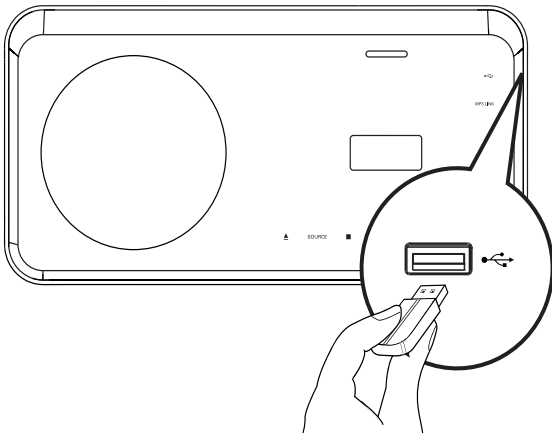

- 1 Connect the USB device to **USB** jack on this Home Theater System.

Note

- This Home Theater System can only play/view MP3, WMA, DivX (Ultra) or JPEG files that are stored on such devices.
- Press **USB** to access the content and play the files.

Connect iPod

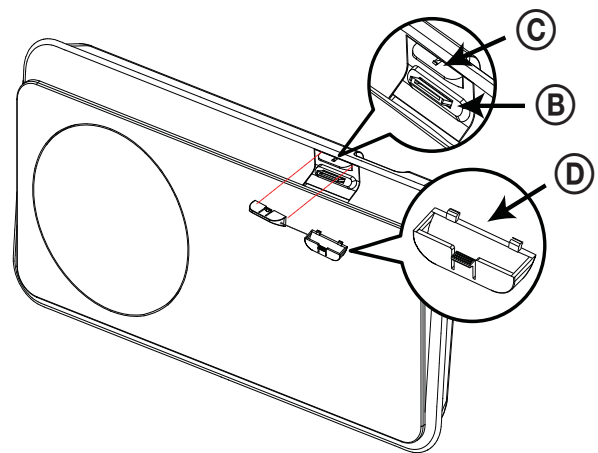
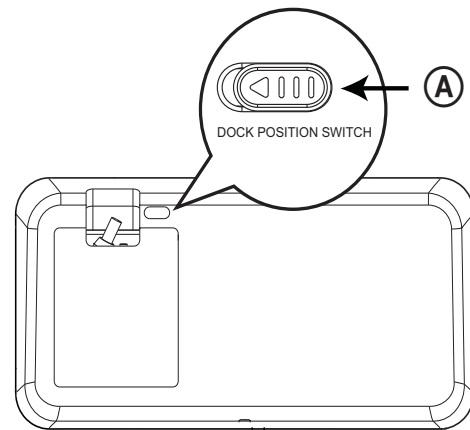

- 1 Push the 'slide' button (A) to one side and move the 'holder' (C) until you get the best position to fit your iPod.
- 2 Release the 'slide' button (A).
- 3 Select a matching dock adaptor (D) and attach it to the 'holder' (C).
- 4 Dock your iPod to **iPod DOCK** slot on this Home Theater System.

Note

- To listen to the audio output from this connection, press **iPod DOCK**.

Connect power cord

Warning

- Risk of product damage! Ensure that the power supply voltage corresponds to the voltage printed on the back or underside of the subwoofer. Set the voltage selector (if any) correctly before you connect the subwoofer to the power outlet.

- 1 Connect the power cord to the power outlet when all the required connections are done.
 - ↳ The Home Theater System is ready to be set up for use.

Attach table stand

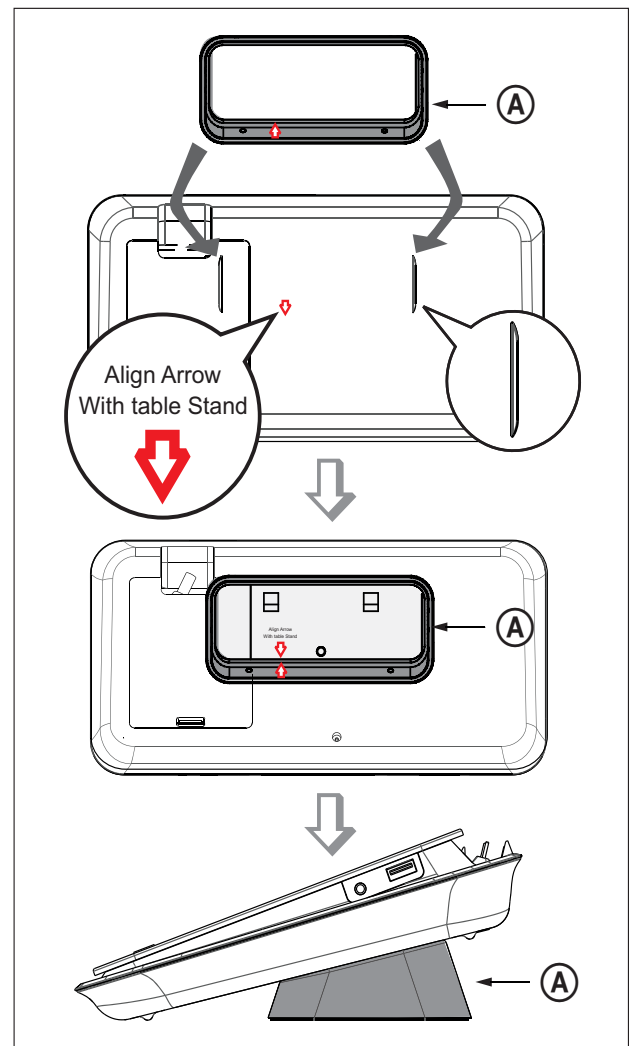

Ⓐ = table stand bracket.

- 1 Ensure all the required cables are connected to this Home Theater System and close the rear cover.
- 2 Attach the table stand bracket to the rear of this Home Theater System.
 - Align the arrow indicators for correct positioning and placement.
 - Use the protrude panels to hold the table stand bracket.

Mount the Home Theater System

! Caution

- Risk of personal injury and damage to the product. Allow only qualified persons to mount the product.

- 1 Ensure all the required cables are connected to this Home Theater System and close the rear cover.
- 2 Attach the big wall mount bracket to the table stand bracket with screws.

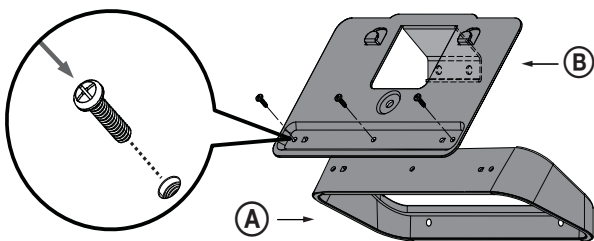

- 3 Position the brackets on the wall, drill four screw holes and secure the brackets onto the wall with screws (not supplied).

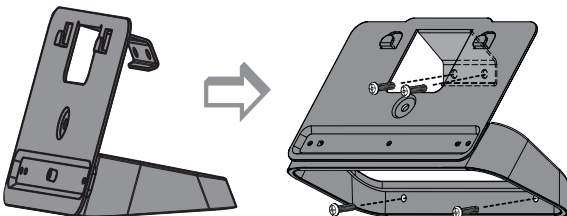

- 4 Hook the Home Theater System firmly onto the mounted bracket.

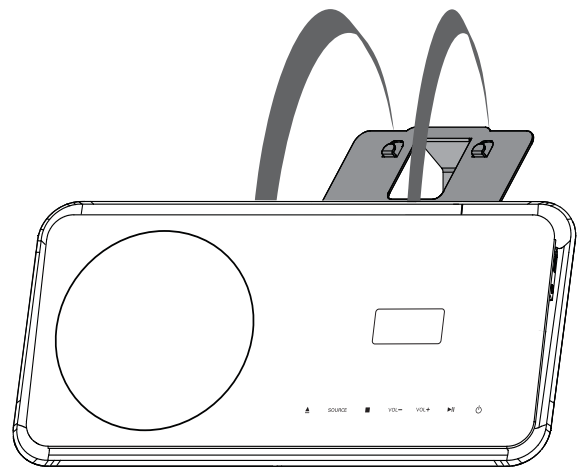

- 5 Screw the supplied knob to the hole at the center rear to secure the bracket.

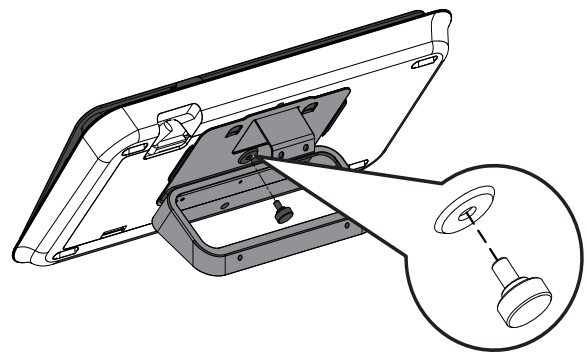

Mount the speakers

! Caution

- Risk of personal injury and damage to the product. Allow only qualified persons to mount the product.

- 1 Loosen the screws at the bottom of the speaker to remove the speaker stand.

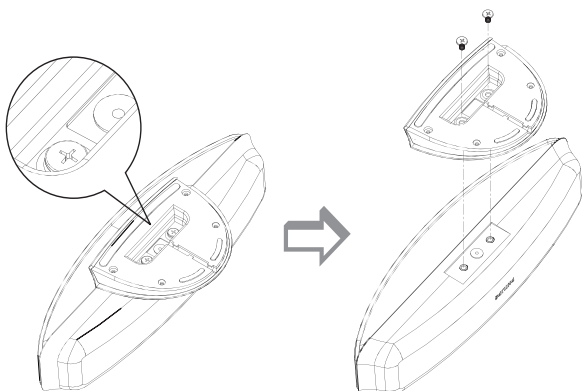

- 2 Attach the small wall mount bracket to the speaker with screws.

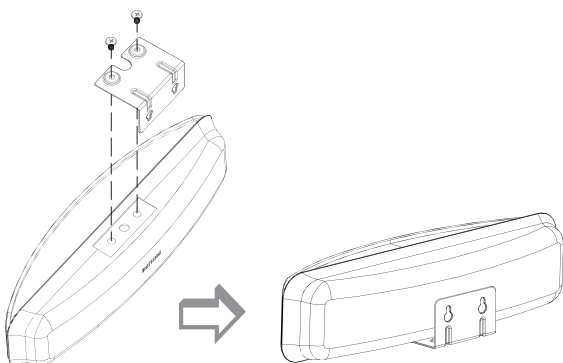

- 3 Fix two screws (not supplied) to the wall, then hook the bracket onto the screws and lock the speaker into position.

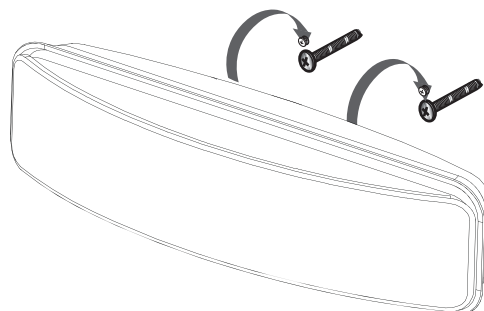

4 Get started

Insert the remote control batteries

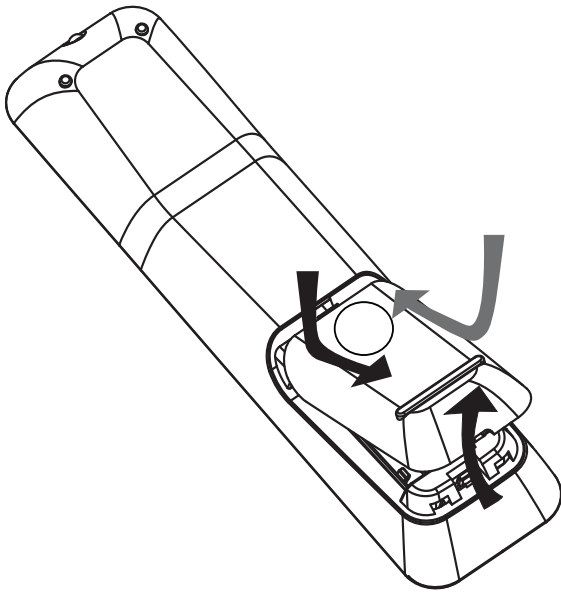

- 1 Slide the battery cover off the back of the remote control.
- 2 Insert the 2 supplied batteries (AAA). Be sure the + and - ends of the batteries line up with the markings inside the case.
- 3 Slide the cover back into position.

Note

- Do not mix batteries (old and new or carbon and alkaline, etc.).
- Remove batteries if they are exhausted or if the remote control is not to be used for a long time.
- Batteries contain chemical substances, they should be disposed of properly.

Control a play source

- 1 Press **RADIO**, **USB** or **DISC** button to select the source you wish to control.
- 2 Select the desired function (for example **◀**, **▶**).

Navigate through the menu

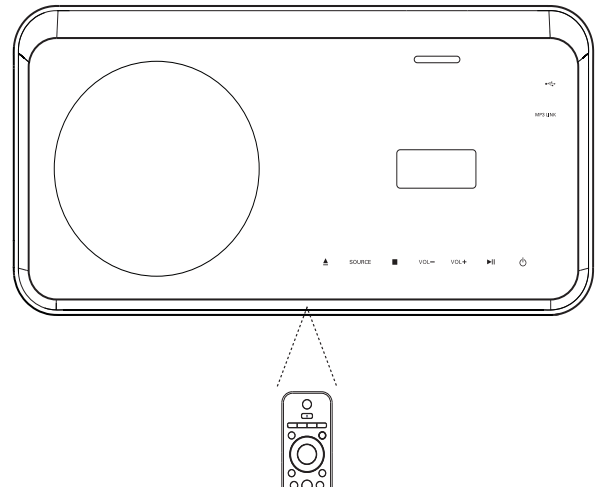

- 1 Point the remote control directly at the remote sensor on the product and select the desired function.
- 2 Press the following buttons on the remote control to navigate through the on-screen menus.

Button	Action
▲▼	Move up or down
◀▶	Move left or right
OK	Confirm a selection
1 2 3	Enter numbers
4 5 6	
7 8 9	
0	

Find the correct viewing channel

- 1 Press **⏻** to turn on the Home Theater System.
- 2 Press **DISC** to switch to disc mode.
- 3 Turn on the TV and switch to the correct video-in channel in one of the following ways:
 - Go to the lowest channel on your TV, then press the Channel Down button until you see the Philips screen.
 - Press **SOURCE** button repeatedly on the remote control of your TV.



Tip

- The video-in channel is between the lowest and highest channels and may be called FRONT, A/V IN, VIDEO, HDMI etc. See the TV user manual on how to select the correct input on the TV.

Select menu display language



Note

- Skip this setting if this Home Theater System is connected to a HDMI CEC compliant TV. It switches automatically to the same OSD menu language as per your TV setting.

General Setup	
EasyLink Setup	<input checked="" type="radio"/> Auto
Disc Lock	<input type="radio"/> English
Display Dim	<input type="radio"/> 中文 (简体)
OSD Language	<input type="radio"/> 中文 (繁體)
Screen Saver	<input type="radio"/> Melayu
Sleep Timer	<input type="radio"/> Русский
Low Power Standby	<input type="radio"/> ไทย
DivX(R) VOD code	

- 1 Press **DISC**.
- 2 Press **SETUP**.
↳ **[General Setup]** menu is displayed.
- 3 Press **▶**.
- 4 Press **▲▼** to select **[OSD Language]** in the menu, then press **▶**.
 - The language options are different depending on your country or region. It may not correspond to the illustration shown here.
- 5 Press **▲▼** to select a language, then press **OK**.



Tip

- You can set the default language for DVD disc menu (see 'Adjust settings' > 'Preferences' > **[Disc Menu]**).

Start Ambisound setup

Change the Ambisound setup according to your room environment and setup in order to obtain the best possible surround sound effect.

Note

- Before you start, ensure that you have made all the required connections.
- Complete the Ambisound setup before you insert a disc to play.

Audio Setup	
Ambisound Setup	
HDMI Audio	
Night Mode	

- 1 Press **DISC**.
- 2 Press **⏏** **SETUP**.
- 3 Press **▼** to select **[Audio Setup]** in the menu, then press **▶**.
- 4 Select **[Ambisound Setup]** in the menu, then press **▶**.
 - If the setup option is not accessible, press **■** twice before you try the above steps again.
- 5 Press **▲▼** to select a setting in the menu, then press **OK**.
 - To exit the menu, press **⏏** **SETUP**.

Ambisound Setup	
Room Acoustics	<input checked="" type="radio"/> Hard
Room Placement	<input checked="" type="radio"/> Soft
Speaker Distance	
Listening Position	

To select the condition of the room

- Select **[Room Acoustics]** and press **▶**.

To select this Home Theater System placement in the room

- Select **[Room Placement]** and press **▶**.

To select the distance between two speakers

- Select **[Speaker Distance]** and press **▶**.

To select the distance between the listening position and the speakers

- Select **[Listening Position]** and press **▶**.

Turn on Progressive Scan

If the TV supports progressive scan output, you can connect this Home Theater System and the TV using component video connection. (see 'Connect video cables' > 'Connect to the component video jack').

Video Setup	
TV System	<input type="radio"/> On
TV Display	<input checked="" type="radio"/> Off
Picture Setting	
HDMI Setup	
Closed Caption	
Progressive	

- 1 Turn on the TV and ensure that the TV progressive scan mode is deactivated (see the TV user manual).
 - 2 Switch the TV to the correct viewing channel for this Home Theater System.
 - 3 Press **DISC**.
 - 4 Press **SETUP**.
 - 5 Press **▼** to select **[Video Setup]** in the menu, then press **▶**.
 - 6 Select **[Progressive]** > **[On]**, then press **OK**.
↳ A warning message is displayed.
 - 7 To proceed, select **[Ok]** and press **OK**.
↳ The progressive setup is complete.
- 8 Press **SETUP** to exit the menu.
 - 9 You can now turn on the progressive scan mode on the TV.

Note

- If a blank/distorted screen is displayed, wait for 15 seconds for the auto recover.
- If no picture displayed, turn off the progressive scan mode as follows: 1) Press **▲** to open the disc compartment. 2) Press **◀**. 3) Press **AUDIO SYNC**.

Note

- During play, when progressive scan mode is on for both this Home Theater System and the TV, distorted picture may display. Turn off the progressive scan feature on both this Home Theater System and the TV.

Use Philips EasyLink

Your Home Theater System supports Philips EasyLink, which uses the HDMI CEC (Consumer Electronics Control) protocol. EasyLink-compliant devices that are connected through HDMI connectors can be controlled by a single remote control.

Note

- Philips does not guarantee 100% interoperability with all HDMI CEC devices.

- 1 Turn on the HDMI CEC operations on the TV and other connected devices. See TVs/devices manual for details.
- 2 You can now enjoy the following Philips EasyLink controls.

EasyLink

You can turn off or turn on all EasyLink features.

One-touch play

When you connect your Home Theater System to devices that support one-touch play, you can control your Home Theater System and the devices with one remote control. For example, when you press Play on your DVD remote control, your TV automatically switches to the correct channel to show the DVD content.

To enable One-touch play, a video disc must be placed in the disc compartment before operation.

One-touch standby

When you connect your Home Theater System to devices that support standby, you can use your Home Theater System remote control to put your Home Theater System and all connected HDMI devices in standby mode. You can perform one-touch standby using the remote control from any of the connected HDMI devices.

System Audio Control

When you connect your Home Theater System to HDMI CEC compliant devices, your Home Theater System can switch automatically to play audio from the connected device.

To use one-touch audio, you must map the audio input from the connected device to your Home Theater System.

Audio Input Mapping

When you map the audio input correctly, this Home Theater System switches to the audio from the played device automatically.

Map the audio inputs to the connected devices



Note

- Before you start, ensure that the audio output of the HDMI TV and other HDMI devices have been connected to the audio input jacks on this Home Theater System.

General Setup	
EasyLink Setup	<input type="radio"/> EasyLink
Disc Lock	<input type="radio"/> One Touch Play
Display Dim	<input type="radio"/> One Touch Standby
OSD Language	<input type="radio"/> System Audio Control
Screen Saver	<input checked="" type="radio"/> Audio Input Mapping
Sleep Timer	
Low Power Standby	
DivX(R) VOD Code	

- 1 Press **DISC**.
- 2 Press **SETUP**.
↳ **[General Setup]** menu is displayed.
- 3 Press **▶**.
- 4 Select **[EasyLink Setup]**, then press **▶**
 - **[One Touch Play]** and **[One Touch Standby]** functions are turned on by default in the factory.
- 5 Select **[System Audio Control] > [On]**, then press **OK** to start scanning devices.
↳ Once complete, audio input mapping menu is displayed.

Audio Input Mapping	
Aux1 Input	<input type="radio"/> [TV]
Aux2 Input	<input type="radio"/> [DVD 3400]
Aux3 Input	<input type="radio"/> other(non-HDMI)
Coaxial Input	
Optical Input	

- 6 Select the audio input of this Home Theater System that is used to connect to other HDMI device, then press **▶**.
 - For example, if the TV audio is connected to the **AUX1** jack on this Home Theater System, select **[Aux1 Input]** and map with the TV (brand name) at the right panel.
- 7 Select the correct connected device, then press **OK**.
↳ Repeat steps 5~7 to map other connected devices.
- 8 Press **SETUP** to exit the menu.

Select a play source

On the main unit

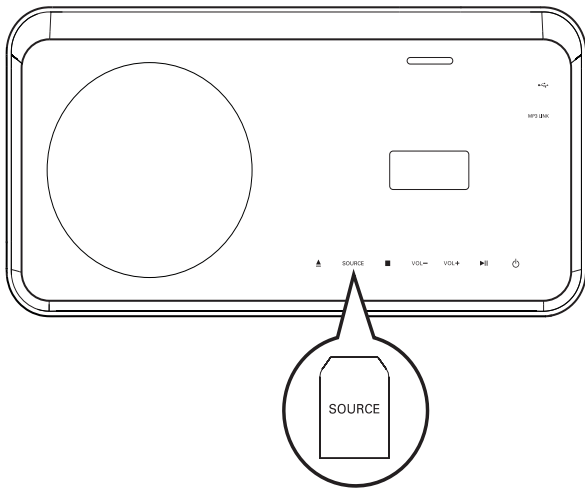

- Press **SOURCE** repeatedly to select:
DISC > IPOD > RADIO FM > COAXIAL INPUT > OPTICAL INPUT > AUX1 INPUT > AUX2 INPUT > AUX3 INPUT > MP3 LINK > USB > DISC ...

On the remote control

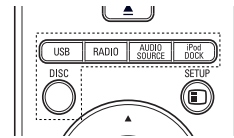

- Press **iPod DOCK** to switch to dock mode.
- Press **AUDIO SOURCE** repeatedly to switch to the connected audio source:

Display	Device connected to
AUX1 INPUT	AUDIO IN-AUX1 jacks
AUX2 INPUT	AUDIO IN-AUX2 jacks
AUX3 INPUT	AUDIO IN-AUX3 jacks
COAXIAL INPUT	DIGITAL IN-COAXIAL jack
OPTICAL INPUT	DIGITAL IN-OPTICAL jack
MP3 LINK	MP3 LINK jack

- Press **RADIO** to switch to FM band.
- Press **USB** to switch to USB mode.
- Press **DISC** to switch to disc mode.

5 Play

Play a disc



Caution

- Never place any objects other than discs into the disc compartment.
- Never touch the disc optical lens inside the disc compartment.

- 1 Press ▲ to open the disc compartment.
- 2 Insert a disc with its label facing up.
 - For double-sided disc, load the side to play faces up.
- 3 Press ▲ to close the disc compartment and start disc play.
 - To view disc play, turn on the TV to the correct viewing channel for this Home Theater System.
 - To stop disc play, press ■.



Note

- Check the types of discs supported (see 'Specifications' > 'Playback media').
- If the password entry menu is displayed, enter the password before you can play the locked or restricted disc.
- If you pause or stop a disc for about 15 minutes, the screen saver activates. To deactivate the screen saver, press **DISC**.
- After you pause or stop a disc and no buttons are pressed within 30 minutes, this Home Theater System automatically switches to standby mode.

Play video



Note

- For video disc, playback always resumes from the point where it was last stopped. To start play from the beginning, press ◀ while the message is displayed.

Control video play

- 1 Play a title.
- 2 Use the remote control to control the title.

Button	Action
▶	Starts, pauses or resumes disc play.
■	Stops disc play.
▶	Skips to the next title or chapter.
◀	Skips to the beginning of the current title or chapter. Press twice to jump to the previous title or chapter.
◀◀ / ▶▶	Searches fast-forward (right) or fast-backward (left). Press repeatedly to change the search speed. In pause mode, slow motion backward or forward play.
▲ / ▼	Searches slow-forward (down) or slow-backward (up). Press repeatedly to change the search speed. For VCD, only slow-forward play is possible.

Change video play

- 1 Play a title.
- 2 Use the remote control to change the video play.

Button	Action
AUDIO SYNC	Selects an audio language or channel on a disc.
SUBTITLE	Selects the subtitle language on a disc.
REPEAT	Selects or turns off repeat or shuffle mode. Repeat options vary depending on the disc type. For VCDs, repeat play is only possible if the PBC mode is turned off.
ZOOM	Zooms in or out of the picture. To pan through the zoomed image, press the Navigation buttons .
i INFO	Displays the current status or disc information. You can change the video play options here without interrupting disc play.

Note

- Some operations may not work with some discs. See the information accompanying the disc for details.

Access DVD menu

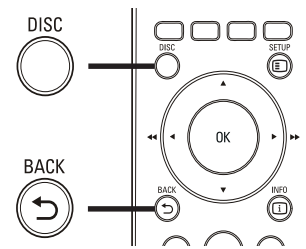

- 1 Press **DISC** to access disc main menu.
- 2 Select a play option, then press **OK**.
 - In some menus, press the **Numeric buttons** to input your selection.
 - To return to the title menu during play, press **↶ BACK**.

Access VCD menu

The PBC (Playback Control) for VCD is activated by default in the factory. When you load in a VCD, the contents menu is displayed.

- 1 Press **▲▼** to select a play option, then press **OK** to start play.
 - If PBC is off, it skips the menu and starts play from the first title.
 - To return to the menu during play, press **↶ BACK** (only possible if the PBC mode is on).

Tip

- You can change the PBC setting (see 'Adjust settings' > 'Preferences' > **[PBC]**).

Sync audio output with video play

If the video play is slower than the audio output (sound does not match with the pictures), you can delay the audio output to match the video.

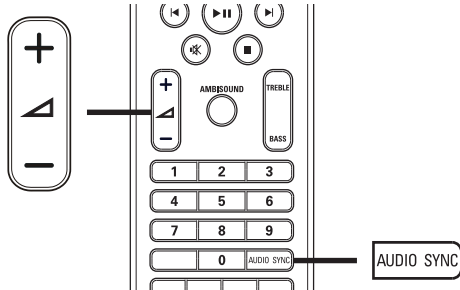

- 1 Press and hold **AUDIO SYNC** until 'AUDIO SYNC' is displayed.
- 2 Within five seconds, press **▲/▼** to set the delay time for audio output.

Note

- If the volume control is not used within five seconds, it resumes normal volume control function.

View video play from different camera angles

- 1 During play, press and hold **ANGLE** to display the angle options.
- 2 Press the **Numeric buttons** to select an angle.
↳ Play changes to the selected angle.

Note

- Applicable only to discs contain multi-angle scenes.

Quick skip play to a specific time

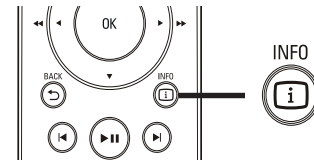

- 1 During play, press **INFO**.
↳ The disc status menu is displayed.
- 2 Press **▲/▼** to view information, then press **OK**.
 - **[TT Time]** (title time)
 - **[Ch Time]** (chapter time)
 - **[Disc Time]** (disc time)
 - **[Track Time]** (track time)
- 3 Press the **Numeric buttons** to enter the time where you want to skip to, then press **OK**.

Note

- The options are different depending on the disc type.

Play DivX® video

DivX video is a digital media format that retains high quality despite a high rate of compression. You can enjoy DivX video on this DivX® Certified Home Theater System.

- 1 Insert a disc or USB that contains the DivX videos.
- 2 Press **DISC** or **USB**.
↳ A contents menu is displayed.
- 3 Select a title to play, then press **▶||**.
- 4 Use the remote control to control the title.

Button	Action
AUDIO SYNC	Selects an audio language or channel.
SUBTITLE	Select DVD or DivX subtitle languages.
■	Stops play. For DivX Ultra video, press this button again to display the contents menu.
i INFO	Displays DivX Ultra video information.

Note

- You can only play DivX videos that were rented or purchased with the DivX registration code of this Home Theater System (see 'Adjust settings' > 'General setup' > **[DivX(R) VOD Code]**).
- You can play DivX video files of up to 4GB.
- If the subtitle does not appear correctly, change the character set (see 'Adjust settings' > 'Preferences' > **[DivX Subtitle]**).
- This Home Theater System can display up to 45 characters in the subtitle.

Play music

Control audio track play

- 1 Play a track.
- 2 Use the remote control to control the track.

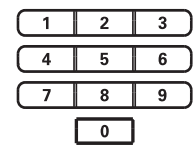
Button	Action
▶ 	Starts, pauses or resumes disc play.
■	Stops disc play.
▶	Skips to the next track.
◀	Skips to the beginning of the current track. Press twice to jump to the previous track.
	Selects an item to play.
◀◀ / ▶▶	Searches fast-forward (right) or fast-backward (left). Press repeatedly to change the search speed.
REPEAT	Selects or turns off repeat or shuffle mode.

Play MP3/WMA music

MP3/WMA is a type of highly compressed audio file (files with .mp3 or .wma extensions).

- 1 Insert a disc or USB that contains the MP3/WMA music.
- 2 Press **DISC** or **USB**.
↳ A contents menu is displayed.
- 3 Select a folder, then press **OK**.
- 4 Select a track to play, then press **▶||**.
 - To return to the main menu, press **↩ BACK** or press **▲** until 'Previous' folder is selected, then press **OK**.

Note

- For disc recorded in multiple sessions, only the first session is played.
- This Home Theater System does not support MP3PRO audio format.
- If any special characters are present in the MP3 track name (ID3) or album name, it might not be displayed correctly on the screen because these characters are not supported.
- Some WMA files are protected by Digital Rights Management and cannot be played on this Home Theater System.
- Folders/files that exceed the supported limit of this Home Theater System will not be displayed or played.

Tip

- You can select the display of data contents, view folders or files (see 'Adjust settings' > 'Preferences' > **[MP3/JPEG Display]**).

Play photo

Play photo as slideshow

This Home Theater System can play JPEG photos (files with .jpeg or .jpg extensions).

- 1 Insert a disc or USB that contains the JPEG photos.
- 2 Press **DISC** or **USB**.
↳ Slideshow begins (for Kodak disc) or a contents menu (for JPEG disc) is displayed.
- 3 Select the folder/album you want to play.
 - To preview the photos in the folder/album, press **i INFO**.

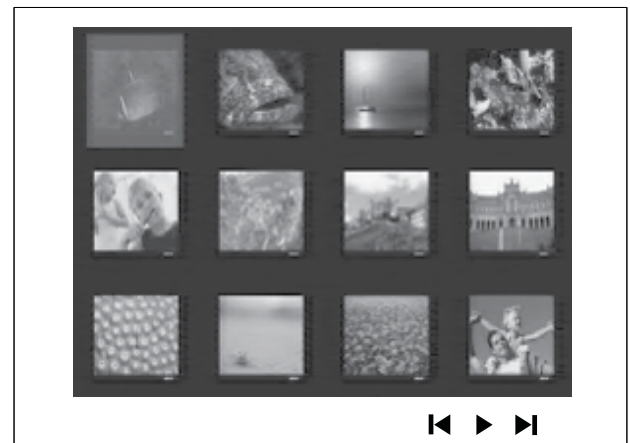

- To go to previous or next screen display, press **◀ / ▶**.
 - To select a photo, press the **Navigation buttons**.
 - To display the selected photo only, press **OK**.
- 4 Press **▶||** to start slideshow play.
 - To return to the menu, press **↩ BACK**.

Note

- You may require longer time to display the disc content on the TV due to the large number of songs/photos compiled onto one disc.
- If the JPEG photo is not recorded with an 'exif' type file, the actual thumbnail picture is not shown on the display. It is replaced by a 'blue mountain' thumbnail picture.
- This Home Theater System can only display digital camera pictures according to the JPEG-EXIF format, typically used by almost all digital cameras. It cannot display Motion JPEG and pictures in formats other than JPEG, or sound clips associated with pictures.
- Folders/files that exceed the supported limit of this Home Theater System are not displayed or played.

Control photo play

- 1 Play photo slideshow.
- 2 Use the remote control to control the photo.

Button	Action
◀	Skips to the previous photo.
▶	Skips to the next photo.
▲	Rotates the photo clockwise.
▼	Rotates the photo anti-clockwise.
ZOOM	Zooms in or out of the picture. Play pause in zoom mode.
■	Stops play.

Play musical slideshow

Play MP3/WMA music files and JPEG photo files simultaneously to create musical slideshow. The MP3/WMA and JPEG files must be stored on the same disc or USB device.

- 1 Play MP3/WMA music.

- 2 Navigate to the photo folder/album and press **OK** to start slideshow play.
 - ↳ Slideshow begins and continues till the end of the photo folder or album.
 - ↳ Audio continues to play till the end of the disc.
 - To stop slideshow play, press **■**.
 - To stop music play, press **■** again.

Play from USB device

This Home Theater System plays/views MP3, WMA, DivX (Ultra) or JPEG files on the following USB devices:

- digital camera that complies with the PTP standard
- flash drive
- memory card reader
- HDD (external power source needed)

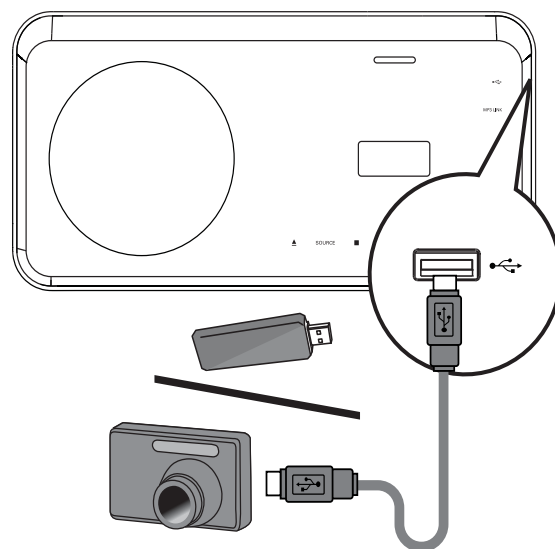

- 1 Connect a USB device to the **USB** jack.
- 2 Press **USB**.
 - ↳ A contents menu is displayed.
- 3 Select a file to play, then press **▶||**.
 - ↳ Play starts.
 - To stop play, press **■** or remove the USB device.

Note

- If the device does not fit into the USB jack, connect it through a USB extension cable.
- If you connect a multiple USB card/device reader, only one card/device can be accessed.

Play from portable media player

Simply connect your portable media player (e.g. MP3 player) to this Home Theater System to enjoy superb sound quality from your music collections.

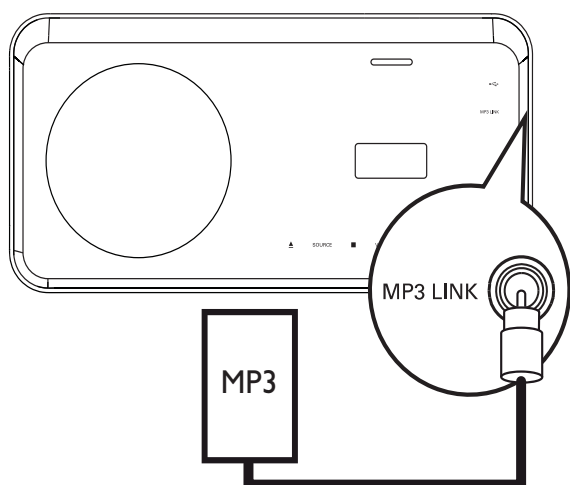

- 1 Connect a 3.5mm stereo audio cable (not supplied) from the **MP3 LINK** jack on this Home Theater System to the 'headphone' jack on the portable media player.
- 2 Press **AUDIO SOURCE** repeatedly until 'MP3 LINK' is displayed.
- 3 Start play on your portable media player.
 - To stop play, press **STOP** on the portable media player.

Note

- Control playback is only possible on the portable media player.
- Stop play on the portable media player before you switch to other play media/source.

Play from iPod

Simply dock your iPod to the **iPod DOCK** slot to enjoy your iPod play through this Home Theater System.

List of supported iPod range:

iPod mini	iPod mini 2nd gen
iPod touch	iPod touch 2nd gen
iPod classic (80/120/160 GB)	iPod nano 1st/2nd/3rd/4th gen
iPod with color display	iPod 5th gen



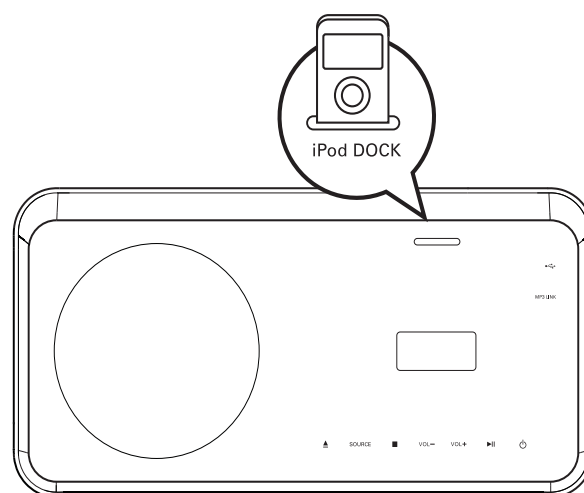

Note

- Refer to the Philips website for latest updates on the supported iPod range.

Control iPod music



- 1 Dock your iPod to the **iPod DOCK** slot and turn it on.
- 2 Press **iPod DOCK**.
 - It may require longer time to authenticate the compatibility of certain iPod range.
- 3 Start play on your iPod.
- 4 Use the remote control to control the music play.

Button	Action
VOL +/-, 	Increases or decreases volume.
SOUND MODE	Selects a predefined sound effect.
AMBISOUND	Selects stereo sound output or multi-channel surround output.
	Skips to the previous or next track.
	Searches fast-forward (right) or fast-backward (left). Press repeatedly to change the search speed.
	Starts, pauses or resumes playback on your EasyLink device.
 INFO	Switches to 'Extended Control mode' to enable control of your iPod play through the contents displayed on TV. Control buttons on iPod have no function in this mode. Press this button again to return to simple play mode.

Note

- While in iPod mode, the battery of your iPod will be charged.
- In 'Extended Control mode', control of iPod play is only possible through the screen display on your TV using the **Navigation buttons** on the remote control.

Play from radio

Check if the FM antenna has been connected to this Home Theater System. If not, connect the supplied FM antenna to the **FM75 Ω** jack and fix its ends to the wall.

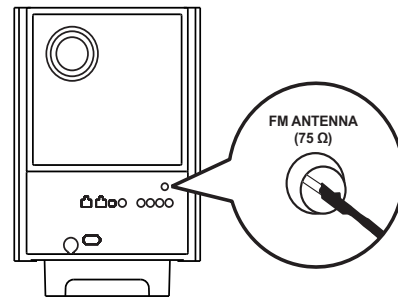



Tip

- For better FM stereo reception, connect an external FM antenna (not supplied).
- Position the antenna as far away as possible from your TV, VCR or other radiation source to prevent interference.

First time tuning

When you access to radio mode for the first time, follow the instructions to install the radio stations.



- 1 Press **RADIO**.
↳ 'AUTO INSTALL ... PRESS PLAY' is displayed.
- 2 Press .
 - ↳ All detected radio stations are stored.
 - ↳ Once complete, it tunes to the first preset radio station.
 - To stop auto tuning, press .

Note

- This Home Theater System can store up to a maximum of 40 radio stations.
- If auto installation is not activated or less than 5 radio stations are stored, you will be prompted to install the radio stations again.

Listen to radio

- 1 Press **RADIO**.
- 2 Use the remote control to control the radio.

Button	Action
	Selects a preset radio station.
	Tunes the radio frequency up or down.
	Press and hold this button to erase the current radio station from the preset list. The preset number for other radio stations remain unchanged.

Tip

- Press **AUDIO SYNC** to toggle between FM stereo and FM mono mode.

Reinstall all the radio stations

- 1 Press **RADIO**.
- 2 Press and hold **PROGRAM** for more than 5 seconds.
 - ↳ All previously stored radio stations are replaced.

Note

- Check the radio antenna connection if no stereo signal is detected or less than 5 stations are detected during radio installation.

Search and store radio stations individually

- 1 Press **RADIO**.
- 2 Press **◀◀ / ▶▶**.
 - ↳ It starts searching until a radio station is detected.
- 3 Repeat step 2 until you tune to the radio station you wish to store.
 - To finetune the radio frequency, press **▲ / ▼**.
- 4 Press **PROGRAM**.
 - ↳ The preset station number blinks.
 - ↳ If no action is carried out within 20 seconds after the above step, it exits the preset mode.
- 5 Press **◀ / ▶** (or the **Numeric buttons**) to select a preset number to store.
- 6 Press **PROGRAM** to confirm.

Change tuning grid

In some countries, the frequency step between adjacent channels in FM band is 50 kHz or 100 kHz.

Note

- This feature only applicable for certain region.
- Change tuning grid erases all preset radio stations.

- 1 Press **RADIO**.
- 2 Press **■**.
- 3 Press and hold **▶▶** until 'GRID 9' or 'GRID 10' is displayed.
 - ↳ 'GRID 9' for 50 kHz and 'GRID 10' for 100 kHz.

6 Adjust sound

Control the volume

- 1 Press \triangleleft +/- (VOL +/-) to increase or decrease the volume.
 - To mute, press \times .
 - To restore the volume, press \times again or press VOL +.

Adjust Bass/Treble

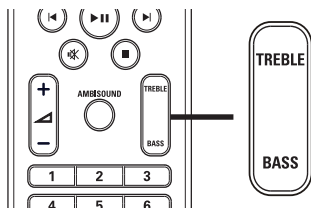

- 1 Press TREBLE or BASS.
- 2 Within 5 seconds, press \triangleleft +/- (VOL +/-) to set the high (TREBLE) or low (BASS) tone level.

Select Ambisound

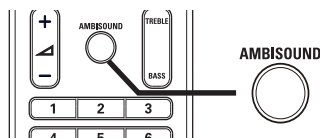

- 1 Press AMBISOUND repeatedly to select the best Ambisound output that most suitable for the video or music you play.

Option	Description
AUTO	Surround output based on the audio stream.
MULTI-CHANNEL	5.1 multi-channel output for a standard movie experience.
STEREO	Stereo sound from two front speakers.

Select a preset sound

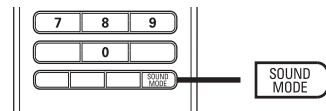





- 1 Press SOUND MODE repeatedly to select the sound effect that most suitable for the video or music you play.

Video/Music	Description
ACTION / ROCK	Enhanced low and high range for great sounding movie effects and atmosphere. Great for action movies and rock/pop music.
CONCERT/ CLASSIC	Flat and pure sound mode. Ideal for listening to classical music and watching live concert disc.
DRAMA / JAZZ	Clear mid and high range. Recreates the atmosphere of a live club with the artist just in front of you. Good for jazz music and watching dramas.
NEWS	Enhanced mid range for clear vocals/speech.
GAMING / PARTY	Slightly enhanced low range and strong mid range ideal for party music and video gaming.
SPORTS	Moderate mid range and surround effects for clear vocals and the atmosphere of a live sports venue.

7 Adjust settings

You can customize various kinds of settings as you prefer. Refer to the following instructions to navigate through the setup menus.

Symbol	Options
	[General Setup]
	[Audio Setup]
	[Video Setup]
	[Preferences]

 **Note**

- If the setup option is grayed out, it means the setting cannot be changed at the current state.

General setup

General Setup	
EasyLink Setup	
Disc Lock	
Display Dim	
OSD Language	
Screen Saver	
Sleep Timer	
Low Power Standby	
DivX(R) VOD Code	

- 1 Press **SETUP**.
↳ [General Setup] menu is displayed.
- 2 Press **▶**.

- 3 Select an option, then press **OK**.
- 4 Select a setting, then press **OK**.
 - To return to the previous menu, press **BACK**.
 - To exit the menu, press **SETUP**.

 **Note**

- See the explanations of the above options in the following pages.

[EasyLink Setup]

If this Home Theater System is connected to HDMI CEC compliant TV/devices, all connected devices can respond to the following commands simultaneously:

Option	Description
[EasyLink]	Turns off or on all EasyLink features. To disable this feature, select [Off].
[One Touch Play]	When you press PLAY , the TV and Home Theater System are turned on. Disc play starts if there is a disc in the Home Theater System. To disable this feature, select [Off].
[One Touch Standby]	When you press and hold STANDBY for at least 3 seconds, the Home Theater System and all the HDMI CEC devices switch to standby simultaneously. To disable this feature, select [Off].
[System Audio Control]	When you play audio that is routed from the connected devices, this Home Theater System switches to the corresponding audio source automatically. To enable this feature, select [On]. Then proceed to [Audio Input Mapping] to scan and map all the connected devices.

Option	Description
[Audio Input Mapping]	When you map the audio input correctly, this Home Theater System switches to the audio from the played device automatically.

Note

- You must turn on the HDMI CEC operations on the TV/devices before you can enjoy the EasyLink controls. See the TV/devices manual for details.
- Philips does not guarantee 100% interoperability with all HDMI CEC compliant devices.

[Disc Lock]

Sets play restriction for a specific discs. Before you start, place the disc in the disc compartment (maximum 40 discs can be locked).

- **[Lock]** – Restricts access to the current disc. Once activated, a password is needed to unlock and play the disc.
- **[Unlock]** – Plays all discs.

Tip

- You can set or change the password (see 'Adjust settings' > 'Preferences' > **[Password]**).

[Display Dim]

Changes the brightness level of the display panel on this Home Theater System.

- **[100%]** – Normal brightness.
- **[70%]** – Medium brightness.
- **[40%]** – Dimmest display.

[OSD Language]

Selects the default on-screen menu language.

[Screen Saver]

Turns off or on the screen saver mode. Helps to protect the TV screen from being damaged due to over exposure to a static image for too long.

- **[On]** – Sets the screen saver to appear after 15 minutes of inactivity (for example, in pause or stop mode).
- **[Off]** – Disables screen saver mode.

[Sleep Timer]

Switches to standby automatically after the preset time.

- **[15 mins], [30 mins], [45 mins], [60 mins]** – Selects the count down time before the Home Theater System switches to standby.
- **[Off]** – Disables sleep timer mode.

[Low Power Standby]

Turns off or on the low power standby mode. Reduces power consumption in standby mode.

- **[On]** – Sets the standby mode to low power.
- **[Off]** – Sets the standby mode to normal power.

[DivX(R) VOD Code]

Displays the DivX® registration code.

Tip

- Enter this Home Theater System DivX registration code when you rent or purchase video from www.divx.com/vod. The DivX videos rented or purchased through the DivX® VOD (Video On Demand) service can be played only on the device to which it is registered.

Audio setup

Audio Setup	
Ambisound Setup	
HDMI Audio	
Night Mode	

- 1 Press **⏏** **SETUP**.
↳ **[General Setup]** menu is displayed.
- 2 Press **▼** to select **[Audio Setup]**, then press **▶**.
- 3 Select an option, then press **OK**.
- 4 Select a setting, then press **OK**.
 - To return to the previous menu, press **⏪** **BACK**.
 - To exit the menu, press **⏏** **SETUP**.

Note

- See the explanations of the above options in the following pages.

[Ambisound Setup]

Optimizes the Ambisound based on this Home Theater System setup in the room (see 'Getting Started' > 'Start Ambisound setup').

Option	Description
[Room Acoustics]	Selects the type of walls that surround the room.
[Room Placement]	Selects the placement in the room.
[Speaker Distance]	Selects the distance between speakers.
[Listening Position]	Selects the distance between the listening position and this Home Theater System.

[HDMI Audio]

Selects the HDMI audio setting when you connect this Home Theater System and the TV with a HDMI cable.

- **[On]** – Allows audio output through the TV and the speaker system. If the audio format on the disc is not supported, it will be downmixed to two-channel sound (linear-PCM).
- **[Off]** – Disables audio output from the TV. The sound is only output through the speaker system.

[Night Mode]

Makes loud sound level softer and soft sound level louder so that you can watch the DVD movies at a low volume, without disturbing others.

- **[On]** – Enjoys quiet viewing at night.
- **[Off]** – Enjoys surround sound with a full dynamic range.

Note

- Applicable only to Dolby Digital encoded discs.

Video setup

Video Setup	
TV System	
TV Display	
Picture Setting	
HDMI Setup	
Closed Caption	
Progressive	

- 1 Press **⏏** **SETUP**.
↳ **[General Setup]** menu is displayed.
- 2 Press **▼** to select **[Video Setup]**, then press **▶**.
- 3 Select an option, then press **OK**.
- 4 Select a setting, then press **OK**.
 - To return to the previous menu, press **⏪** **BACK**.
 - To exit the menu, press **⏏** **SETUP**.

Note

- See the explanations of the above options in the following pages.

[TV System]

Change this setting if the video does not appear correctly. By default, this setting matches the most common setting for TVs in your country.

- **[PAL]** – For PAL-system TV.
- **[NTSC]** – For NTSC-system TV.
- **[Multi]** – For TV that is compatible with both PAL and NTSC.

[TV Display]

Selects one of the following display formats:



4:3 Pan Scan (PS)



4:3 Letter Box (LB)



16:9 (Wide Screen)

- **[4:3 Pan Scan]** – For 4:3 screen TV: full-height display with the trimmed sides.
- **[4:3 Letter Box]** – For 4:3 screen TV: wide-screen display with black bars on the top and bottom of the screen.
- **[16:9 Wide Screen]** – For wide-screen TV: display ratio 16:9.

[Picture Setting]

Selects a predefined set of picture color settings or customize the personal setting.

- **[Standard]** – Original color setting.
- **[Bright]** – Vibrant color setting.
- **[Soft]** – Warm color setting.
- **[Personal]** – Customizes the color setting. Set the level of brightness, contrast, sharpness/tint and color saturation, then press **OK**.

[HDMI Setup]

Selects the HDMI video setting when you connect this Home Theater System and the TV with a HDMI cable.

- **[Wide Screen Format]** – Defines wide screen format for disc play.

Option	Description
[Superwide]	Center position of the screen is stretched less than the side. Applicable only to 720p and above video resolution setting.
[4:3 Pillar Box]	No stretching of picture. Black bars are displayed on both sides of the screen.
[Off]	Picture is displayed according to the disc format.

Note

- This setting is only available if you have set the **[TV Display]** setting to **[16:9 Wide Screen]**.

- **[HDMI Video]** – Selects the HDMI video output resolution that is compatible with your TV display capability.

Option	Description
[Auto]	Detects and selects the best supported video resolution automatically.
[480i], [480p], [576i], [576p], [720p], [1080i], [1080p]	Selects a video resolution that is best supported by the TV. See the TV manual for details.

Note

- If the setting is not compatible with your TV, a blank screen appears. Wait for 15 seconds for auto recover or press **HDMI** repeatedly until the picture appears.

[Closed Caption]

Turns off or on display captions.

- **[On]** – Shows the sound effects in subtitles. Applicable only to discs with Closed Caption information included and the TV supports this feature.
- **[Off]** – Disables closed caption.

[Progressive]

If the TV supports progressive scan output, you can turn on the progressive scan mode to enhance the picture quality. Video connection through Component Video is required.

- **[On]** – Turns on progressive scan mode.
- **[Off]** – Disables progressive scan mode.

Tip

- There is more detailed description available (see 'Get started' > 'Turn on Progressive Scan').

Preferences

Note

- Stop disc play before you can access to **[Preferences]**.

Preferences	
Audio	
Subtitle	
Disc Menu	
Parental	
PBC	
MP3/JPEG Display	
Password	
DivX Subtitle	▼

- 1 Press **⏏** **SETUP**.
↳ **[General Setup]** menu is displayed.
- 2 Press **▼** to select **[Preferences]**, then press **▶**.
- 3 Select an option, then press **OK**.
- 4 Select a setting, then press **OK**.
 - To return to the previous menu, press **↶** **BACK**.
 - To exit the menu, press **⏏** **SETUP**.

Note

- See the explanations of the above options in the following pages.

[Audio]

Selects the default audio language for disc play.

[Subtitle]

Selects the default subtitle language for disc play.

[Disc Menu]

Selects the language for disc menu.

**Note**

- If the language you have set is not available on the disc, the disc uses its own default language.
- For some discs, the subtitle/audio language can only be changed from the disc menu.
- To select the languages that are not listed in the menu, select **[Others]**. Then check the Language Code list at the back of this user manual and enter the respective 4-digit language code.

[Parental]

Restricts access to discs that are unsuitable for children. These types of discs must be recorded with ratings.

- 1) Press **OK**.
- 2) Select a rating level, then press **OK**.
- 3) Press the **Numeric buttons** to enter the password.

**Note**

- Rated discs above the level you set in **[Parental]** require a password to be played.
- The ratings are country-dependent. To allow all discs to play, select **'8'**.
- Some discs have ratings printed on them but are not recorded with ratings. This function has no effect on such discs.

**Tip**

- You can set or change the password (see 'Preferences' > **[Password]**).

[PBC]

Turns off or on the content menu of VCDs/SVCDs with PBC (playback control) feature.

- **[On]** - Displays index menu when you load a disc for play.
- **[Off]** - Skips the menu and start play from the first title.

[MP3/JPEG Display]

Selects to display the folders or display all the files.

- **[View Folders]** – Displays the folders of MP3/WMA files.
- **[View Files]** – Displays all the files.

[Password]

Sets or changes the password for locked discs and play restricted DVDs.

Change Password	
Old Password	<input type="text"/>
New Password	<input type="text"/>
Confirm Password	<input type="text"/>
OK	

- 1) Press the **Numeric buttons** to enter '136900' or the last set password at **[Old Password]** field.
- 2) Enter the new password at **[New Password]** field.
- 3) Enter the new password again at **[Confirm Password]** field.
- 4) Press **OK** to exit the menu.

**Note**

- If you forget the password, enter '136900' before you set a new password.

[DivX Subtitle]

Selects a character set that supports the DivX subtitle.

[Standard]	English, Irish, Danish, Estonian, Finnish, French, German, Italian, Portuguese, Luxembourgish, Norwegian (Bokmål and Nynorsk), Spanish, Swedish, Turkish
[Chinese(Simp)]	Simplified Chinese
[Korean]	Korean



Note

- Ensure that the subtitle file has the exact same file name as the movie file. If for example the file name of the movie is 'Movie.avi', then you will need to name the text file 'Movie.sub' or 'Movie.srt'.

[Version Info.]

Displays the software version of this Home Theater System.



Tip

- This information is required when you want to find out if a newest software version is available at the Philips website that you may download and install on this Home Theater System.

[Default]

Resets all the settings of this Home Theater System to factory default, except for **[Disc Lock]**, **[Password]** and **[Parental]** settings.

8 Additional Information

Update software

To check for new updates, compare the current software version of your Home Theater System with the latest software version (if available) at the Philips website.

Preferences	
Disc Menu ▲	
Parental	
PBC	
MP3/JPEG Display	
Password	
DivX Subtitle	
Version Info.	
Default	

- 1 Press **SETUP**.
- 2 Select **[Preferences] > [Version Info.]**, then press **OK**.
- 3 Write down the version number, then press **SETUP** to exit the menu.
- 4 Go to www.philips.com/support to check the latest software version available for this Home Theater System.
- 5 If the latest software version is higher than the software version of this Home Theater System, download it and store onto a CD-R or USB flash drive.
- 6 Insert the CD-R or USB flash drive to this Home Theater System.
- 7 Press **DISC** or **USB**, then follow the instruction on the TV to confirm update operation.
 - ↳ Once software update is complete, this Home Theater System turns off to standby automatically.

Note

- Do not remove the CD-R or USB when software updating is in progress.

- 8 Disconnect the power cord for a few seconds and connect again to reboot the system.

Care

Caution

- Never use solvents such as benzene, thinner, cleaners available commercially, or anti-static sprays intended for discs.

Clean discs

Wipe the disc with a micro fibre cleaning cloth from the centre to the edge in a straight line movement.

Clean main unit screen

Wipe the screen surface with a micro fibre cleaning cloth.

9 Specifications

Note

- Specification and design are subject to change without notice

Playback media

- DVD-Video, DVD+R/+RW, DVD-R/-RW, DVD+R DL, CD-R/CD-RW, Audio CD, Video CD/SVCD, Picture CD, MP3-CD, WMA-CD, DivX-CD, USB flash drive

Amplifier

- Total output power: 600 W RMS
- Frequency response: 30 Hz ~ 20 kHz / ± 3 dB
- Signal-to-noise ratio: > 65 dB (CCIR)
- Input sensitivity:
 - AUX1/2/3 : 250 mV
 - MP3 LINK: 100 mV

Disc

- Laser Type: Semiconductor
- Disc diameter: 12cm / 8cm
- Video decoding: MPEG1/ MPEG2 / DivX / DivX Ultra
- Video DAC: 12 bits, 108 MHz
- Signal system: PAL / NTSC
- Video S/N: 56 dB
- Audio DAC: 24 bits / 96 kHz
- Frequency response:
 - 4 Hz - 20 kHz (44.1 kHz)
 - 4 Hz - 22 kHz (48 kHz)
 - 4 Hz - 44 kHz (96 kHz)
- PCM: IEC 60958
- Dolby Digital: IEC 60958, IEC 61937
- DTS: IEC 60958, IEC 61937

Radio

- Tuning range: FM 87.5-108 MHz (50/100 kHz)
- 26 dB quieting sensitivity: FM 22 dB
- IF rejection ratio: FM 60 dB
- Signal-to-noise ratio: FM 60 dB
- Harmonic distortion: FM 3%
- Frequency response: FM 180 Hz~10 kHz / ± 6 dB
- Stereo separation: FM 26 dB (1 kHz)
- Stereo Threshold: FM 29 dB

USB

- Compatibility: Hi-Speed USB (2.0)
- Class support: UMS (USB Mass Storage Class)
- File system: FAT12, FAT16, FAT32

Main Unit

- Dimensions (WxHxD): 419 x 48 x 214 (mm)
- Weight: 1.7 kg

Ambisound speakers

- System: full range satellite
- Speaker impedance: 8 ohm/channel
- Speaker drivers: 2.5" full range/channel
- Frequency response: 120 Hz - 20 kHz
 - Dimensions (WxHxD): 335.5 x 113 x 128.5 (mm)
 - Weight: 1.72kg/each

Power (Subwoofer)

- Power supply: 110-127V/220-240V;~50-60Hz switchable
- Power consumption: 150 W
- Standby power consumption:
 - Normal: <3 W
 - Low Power: < 0.3 W
- System: Bass Reflex System
- Impedance: 4 ohm
 - Speaker drivers: 165 mm (6.5") woofer
- Frequency response: 30 Hz ~ 120 Hz
 - Dimensions (WxHxD): 295 x 440 x 295 (mm)
 - Weight: 10 kg

Laser specification

- Type: Semiconductor laser GaAlAs (CD)
- Wave length: 645 - 660 nm (DVD), 770 - 800 nm (CD)
- Output power: 6 mW (DVD), 7 mW (VCD/CD)
- Beam divergence: 60 degrees.

10 Troubleshooting



Warning

- Risk of electric shock. Never remove the casing of the product.

To keep the warranty valid, never try to repair the product yourself.

If you encounter problems when using the product, check the following points before requesting service. If the problem remains unsolved, register your product and get support at www.philips.com/welcome.

If you contact Philips, you will be asked for the model and serial number of your Home Theater System. The model number and serial number are on the back or bottom of your Home Theater System. Write the numbers here:

Model No. _____

Serial No. _____

Main unit

The buttons on this Home Theater System do not work.

- Disconnect this Home Theater System from the power outlet for a few minutes, then connect again.

Picture

No picture.

- See TV's manual for correct video input channel selection. Change the TV channel until you see the DVD screen.
- Press **DISC**.
- If you have changed the **[TV Display]** setting, switch back to default mode: 1) Press **▲** to open the disc compartment. 2) Press **◀**. 3) Press **SUBTITLE**.

No picture on HDMI connection.

- Check if the HDMI cable is faulty. Replace a new HDMI cable.
- If this happens when you change the HDMI video resolution, press **HDMI** repeatedly until the picture appears.

Sound

No sound.

- Ensure that the audio cables are connected and press the correct input source (for example, **AUDIO SOURCE**, **USB**) to select the device you want to play.

No sound on HDMI connection.

- Sound cannot transmit through HDMI connection if the connected device is non-HDCP compliant or only DVI-compatible. Make an analog or digital audio connection.
- Ensure that the **[HDMI Audio]** setting is turned on.

No sound from TV program.

- Connect an audio cable from the AUDIO input on this Home Theater System to the AUDIO output on your TV. Then press **AUDIO SOURCE** repeatedly to select the corresponding audio input source.

Play

DivX video files cannot be played.

- Ensure that the DivX file is encoded according to the 'Home Theater Profile' with the DivX encoder.
- Ensure that the DivX video file is complete.

The aspect ratio of the screen is not aligned with the TV display setting.

- The aspect ratio is fixed on the disc.

DivX subtitle does not display correctly.

- Ensure that the subtitle file name is the same as the movie file name.
- Select the correct character set: 1) Press **⏏** **SETUP**. 2) Select **[Preferences]**, then press **▶**. 3) Select **[DivX Subtitle]**, then press **OK**. 4) Select the character set that supports the subtitle.

The contents of the USB flash drive cannot be read.

- The USB flash drive format is not compatible with this Home Theater System.
- Drive is formatted with different file system which is not supported by this unit (e.g. NTFS).
- Maximum size of memory supported is 160GB.

The video (movies, photos, video clips, etc.) contents of the iPod does not display in Extended Control mode.

- Video browsing is not supported in Extended Control mode, you can only browse the video contents on the iPod itself.

11 Glossary

A

Aspect ratio

Aspect ratio refers to the length to height ratio of TV screens. The ratio of a standard TV is 4:3, while the ratio of a high-definition or wide TV is 16:9. The letter box allows you to enjoy a picture with a wider perspective on a standard 4:3 screen.

D

DivX Video

DivX® is a digital video format created by DivX, Inc. This is an official DivX Certified device that plays DivX video. Visit www.divx.com for more information and software tools to convert your files into DivX video.

DivX Video-On-Demand

This DivX Certified ® device must be registered in order to play DivX Video-on-Demand (VOD) content. To generate the registration code, locate the DivX VOD section in your device setup menu. Go to vod.divx.com with this code to complete the registration process and learn more about DivX video.

Dolby Digital

A surround sound system developed by Dolby Laboratories that contains up to six channels of digital audio (front left and right, surround left and right, center and subwoofer.)

DTS

Digital Theatre Systems. A surround sound system for providing 5.1 channels of discrete digital audio in consumer electronics products and software content. It is not developed by Dolby Digital.

H

HDCP

High-bandwidth Digital Content Protection. This is a specification that provides a secure transmission of digital contents between different devices (to prevent unauthorized copyright.)

HDMI

High-Definition Multimedia Interface (HDMI) is a high-speed digital interface that can transmit uncompressed high definition video and digital multichannel audio. It delivers high quality picture and sound quality, completely free from noise. HDMI is fully backward-compatible with DVI.

As required by the HDMI standard, connecting to HDMI or DVI products without HDCP (High-bandwidth Digital Content Protection) will result in no Video or Audio output.

J

JPEG

A very common digital still picture format. A still-picture data compression system proposed by the Joint Photographic Expert Group, which features small decrease in image quality in spite of its high compression ratio. Files are recognized by their file extension '.jpg' or '.jpeg.'

M

MP3

A file format with a sound data compression system. MP3 is the abbreviation of Motion Picture Experts Group 1 (or MPEG-1) Audio Layer 3. With the MP3 format, one CD-R or CD-RW can contain about 10 times more data than a regular CD.

MPEG

Motion Picture Experts Group. A collection of compression systems for digital audio and video.

P

PBC

Playback Control. A system where you navigate through a Video CD/Super VCD with on-screen menus that are recorded onto the disc. You can enjoy interactive playback and search.

PCM

Pulse Code Modulation. A digital audio encoding system.

Progressive scan

The progressive scan displays twice the number of frames per second than in an ordinary TV system. It offers higher picture resolution and quality.

W

WMA

Windows Media™ Audio. Refers to an audio compression technology developed by Microsoft Corporation. WMA data can be encoded with Windows Media player version 9 or Windows Media player for Windows XP. Files are recognized by their file extension '.wma.'

Register your product and get support at
www.philips.com/welcome

DUMMY TITLE

000000000000

PHILIPS