

PHILIPS

Home Access

Smart deadbolt

4000 series

User Manual

Register your product and get
support at www.philips.com/support



Contents

1 Warnings & Safety **02**

Safety
Caution
Returns & Disposal

2 How to Install **03**

Parts List
Assembly View
Install the Lock
Install the Door Position Sensor

3 How to Setup **13**

Download the Philips Home Access App
Create a User Account
Add the Device
Calibrate the Door Position Sensor

4 How to Use **14**

Feature Definitions
Factory Reset & Default Settings
Format of Entry Methods
Program the Lock
Lock & Unlock

5 Troubleshooting **22**

6 Warranty **24**

7 FCC Statement **25**

8 ISED Statement **25**

1 Warnings & Safety

Safety

- ◆ Before using this product, please read and understand all instructions. Damage caused by failure to follow the instructions is not covered by the warranty.
- ◆ Only use components the manufacturer provided and suggested accessories.
- ◆ Only use AA alkaline batteries.
- ◆ Do not forcibly disassemble the product to trigger an alarm or damage the product.
- ◆ Do not remove the batteries during lock setup and operation.
- ◆ Change the default master PIN code immediately via the Philips Home Access app after completing the installation.

Caution

- ◆ Do not place the batteries near fire sources.
- ◆ Do not connect the 2 poles of the batteries to metals to avoid a short circuit and potential explosion.
- ◆ Any replacement component should be performed by Philips, a Philips-authorized service center, or a professional technician.
- ◆ Do not use parts or accessories manufactured by others, except batteries.
- ◆ Do not expose products to places that have water leakage or splashing.

Returns & Disposal

- ◆ Locks can be returned at an authorized Philips service center. Appropriate compensation will be provided if the returned product meets Philips's conditions.
- ◆ Please follow local regulations and do not throw the used products or batteries into normal household waste.

2 How to Install

Parts List



① Exterior Assembly

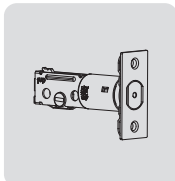

② Latch Bolt

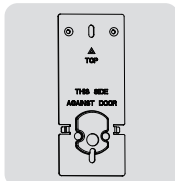

③ Mounting Plate

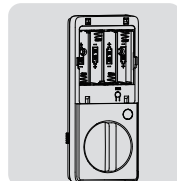

④ Interior Assembly

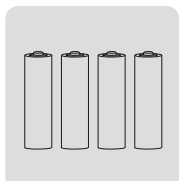

⑤ AA Batteries (4)

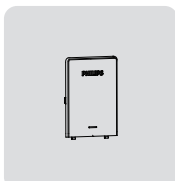

⑥ Battery Cover

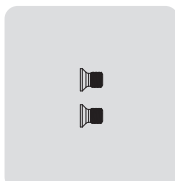

⑦ Interior Assembly Screws (2)

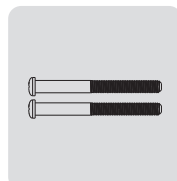

⑧ Mounting Plate Screws (2)

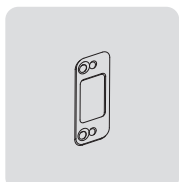

⑨ Reinforcement Plate (Optional)

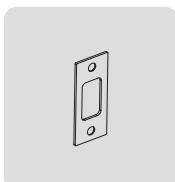

⑩ Strike Plate

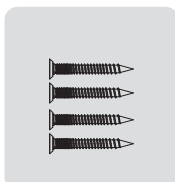

⑪ Strike Plate Screws (2)
Reinforcement Plate Screws (2)

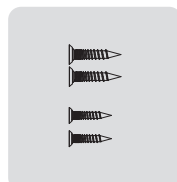

⑫ Latch Bolt Screws (2)
Door Sensor Screws (2)

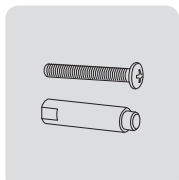

⑬ Upper Screw & Screw Post (Optional)

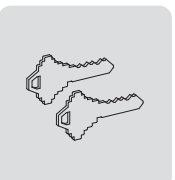

⑭ Backup Keys

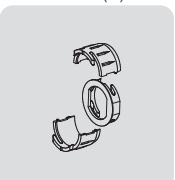

⑮ Drive-In Collar (Optional)

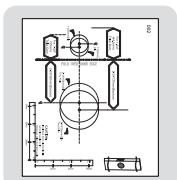

⑯ Drilling Template

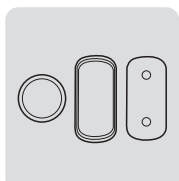

⑰ Door Position Sensor
Door Position Sensor Cap



⑱ User Manual



⑲ Door Position Sensor
Mounting Template



⑳ Quick Start Guide

Assembly View

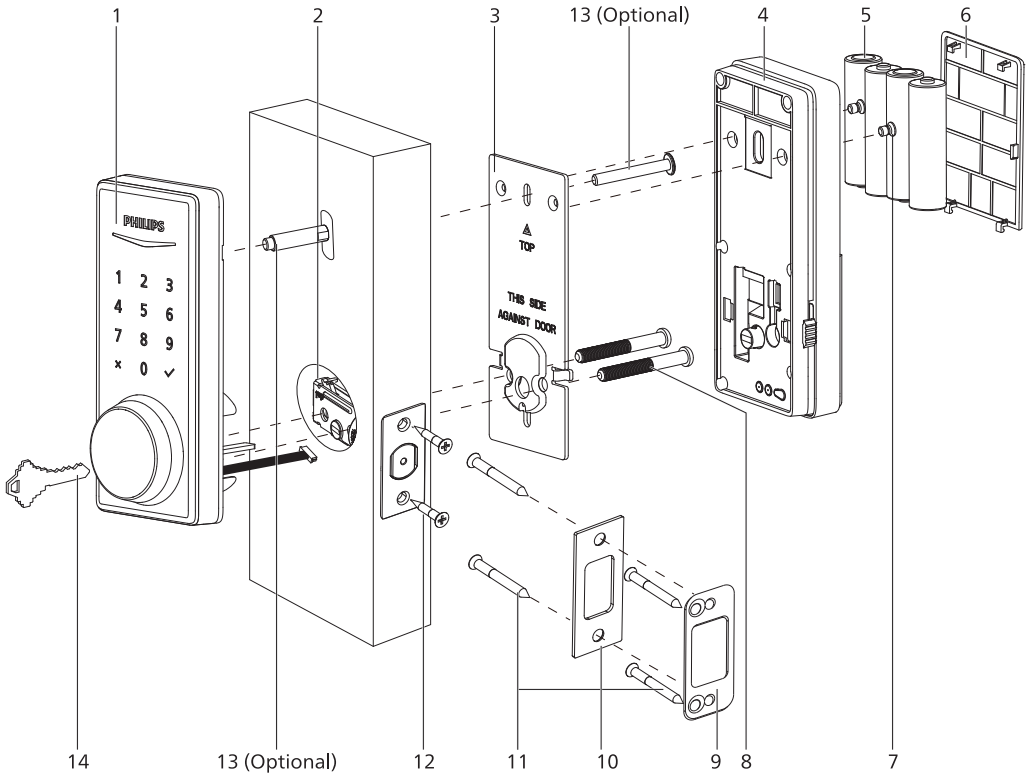

- | | |
|--------------------------------------------------------------------------------------------------------------------------------------------------------------------------------------------------------------------------------------------------------|-----------------------------------------------------------------------------------------------------------------------------------------------------------------------------------------------------------------------------------------------------------------------------------------------------------------------------------------------------------|
| <ol style="list-style-type: none"> 1. Exterior Assembly 2. Latch Bolt 3. Mounting Plate 4. Interior Assembly 5. AA Batteries (4) 6. Battery Cover 7. Interior Assembly Screws (2) | <ol style="list-style-type: none"> 8. Mounting Plate Screws (2) 9. Reinforcement Plate (Optional) 10. Strike Plate 11. Strike Plate Screws (2)
Reinforcement Plate Screws (Optional) (2) 12. Latch Bolt Screws (2) 13. Upper Screw and Screw Post (Optional) 14. Backup Keys (2) |
|--------------------------------------------------------------------------------------------------------------------------------------------------------------------------------------------------------------------------------------------------------|-----------------------------------------------------------------------------------------------------------------------------------------------------------------------------------------------------------------------------------------------------------------------------------------------------------------------------------------------------------|

Exterior Assembly

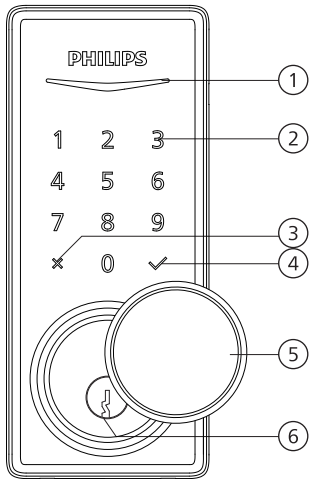

1	Status Indicator
2	Touchscreen Keypad
3	Cancel Key
4	Confirm Key
5	Keyhole Cover
6	Keyhole

Interior Assembly

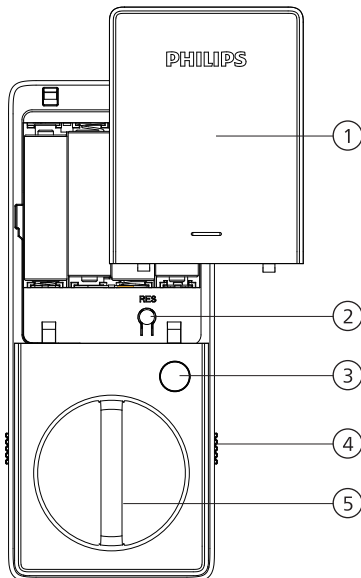

1	Battery Cover
2	Reset Button
3	Privacy Button
4	Installation Buckle
5	Thumb Turn

Install the Lock

Required Tools



#2 Phillips Screwdriver

Prepare the Door and Check the Dimensions

- ① Measure to confirm that the hole in the door is 1-1/2" or 2-1/8" (38mm or 54mm).
Measure to confirm that the hole in the door edge is 1" (25mm).
- ② Measure to confirm that the backset is either 2-3/8" or 2-3/4" (60mm or 70mm).

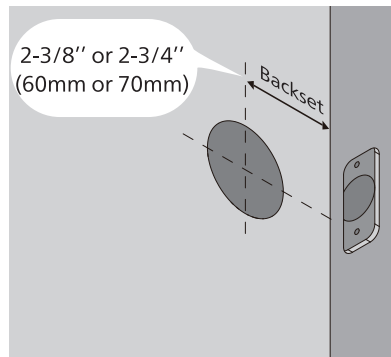
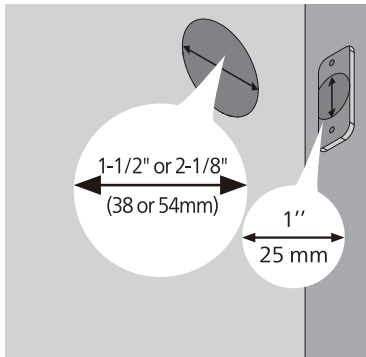

- ③ Measure to confirm that the door is 1-3/8" to 2" (35mm to 50mm) thick.
- ④ Make sure the hole in the door frame is drilled a minimum of 1" (25mm) deep to leave enough space for the deadbolt to extend into the door frame when the door is locked.

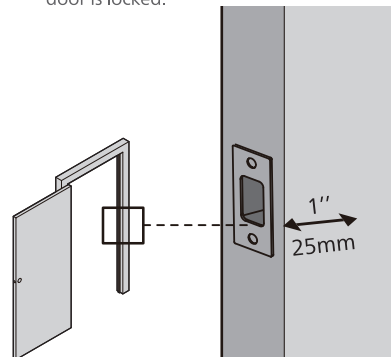
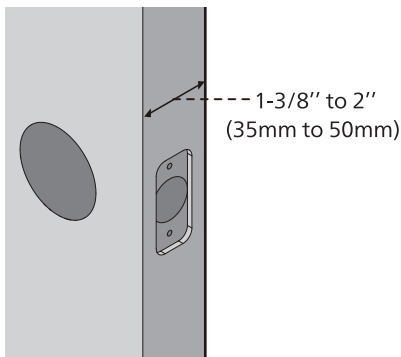

⚠ Attention

Make sure the door frame is aligned with the door and there are no obstructions in the door frame.

5 OPTIONAL: Drill a hole for Upper Screw.

⚠ Attention

Installing this screw onto the Exterior Assembly is OPTIONAL. It is used for additional security or when a door is weak or warped.

If you install this screw, you need to drill a hole (19/32") in the door before starting the installation.

Drilling Template

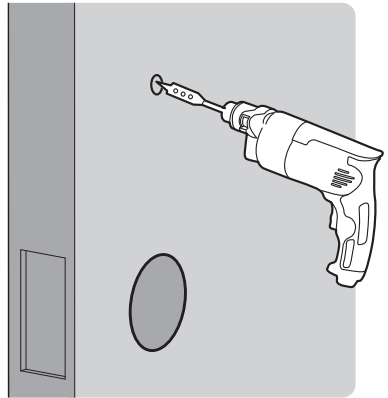
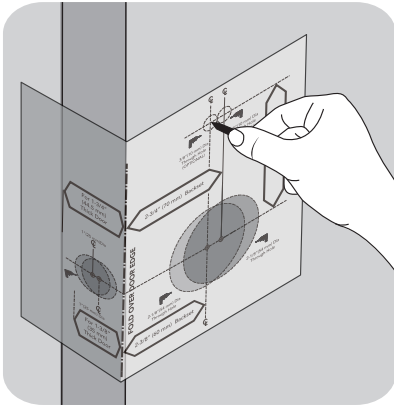

⑥ Determine the backset and adjust the Latch Bolt.

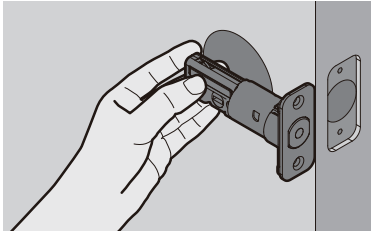

Hold the Latch Bolt in front of the door hole, with the Latch Bolt face flush against the door edge. Is the slotted hole centered in the door hole?

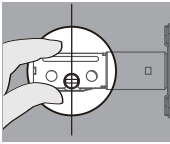

YES

No adjustment is required.
Proceed to the next step.

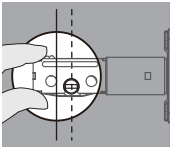

NO

The slotted hole is NOT centered.
Rotate and pull the Latch Bolt as shown to extend it.

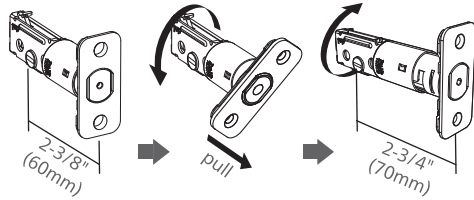

⑦ Install the Latch Bolt.

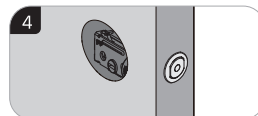
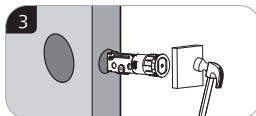
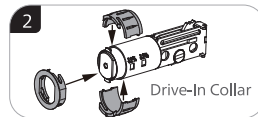
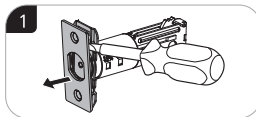
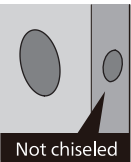
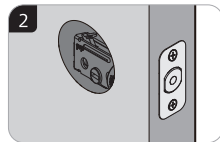
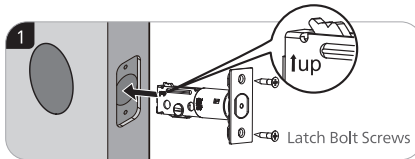

- 8 Use a screwdriver to confirm that the deadbolt locks and unlocks smoothly.

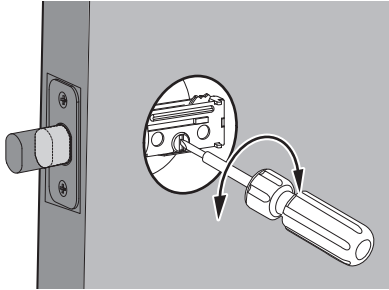

- 9 Install the Strike Plate on the door frame.

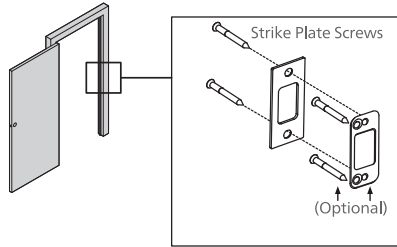

Attention

Make sure the hole in door frame is drilled a minimum of 1"(25mm) deep.

Install the Exterior Assembly

Attention

Before installing the Exterior and Interior Assembly, make sure the Latch Bolt is fully retracted (in the unlocked position).



Do not insert the key when you are installing.

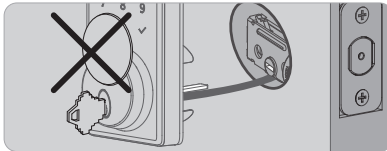

Measure the diameter of the hole in the door.

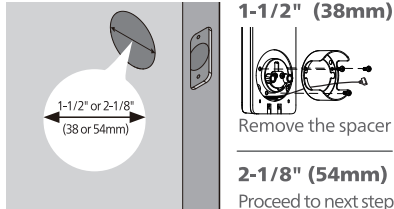

- 10 With the Latch Bolt fully retracted (in the unlocked position), route the cable below the Latch Bolt, and insert the tailpiece through the slot in the Latch Bolt.

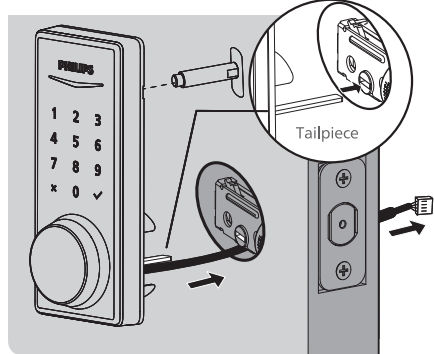

Attention

The Upper Screw & Screw Post on the top is OPTIONAL. It is used for additional security, or when a door is weak or warped.

- 11 Move the Installation Buckles on both sides of the Interior Assembly upwards to remove the Mounting Plate from the interior base.

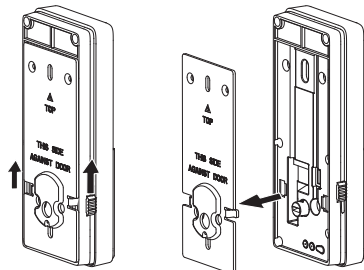

- 12 Secure the Mounting Plate with the Mounting Plate Screws. Do not overtighten screws.

⚠ Attention

Route the cable through the hole in the mounting plate.

The Upper Screw on the top is OPTIONAL.

Before installing the Upper Screw, fasten the Screw Post into the hole of the Exterior Assembly.

Keep parallel to door edge.

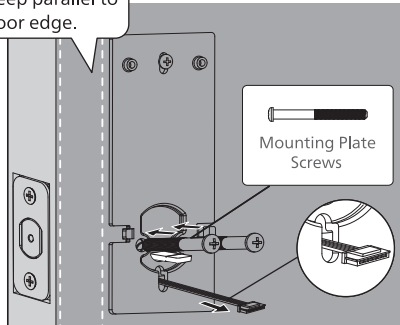

Install the Interior Assembly

- 13 Push the Battery Cover up in the direction as illustrated.

⚠ Attention

Do not load batteries before finishing the lock installation.

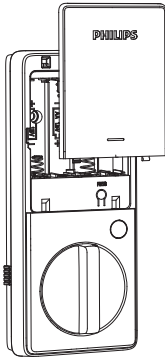

- 14 Insert the cable connector of the Exterior Assembly to the socket on the Interior Assembly. Push the connector in firmly until it is completely attached.

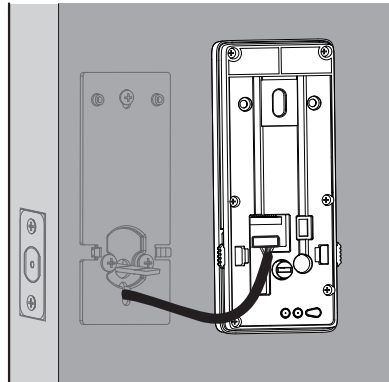

- 15 Keep the Thumb Turn in the vertical position, toggle the Installation Buckle upwards, and install the Interior Assembly.

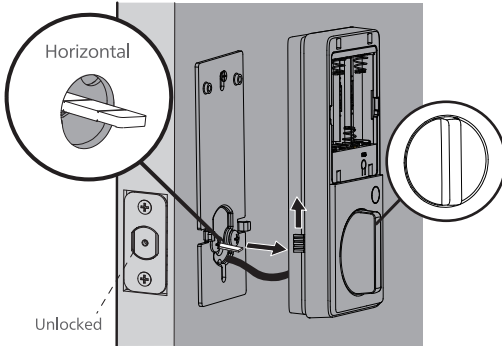

- 16 Attach the Interior Assembly to the Mounting Plate, toggle the Installation Buckle downwards, and fasten using the Interior Assembly Screws.

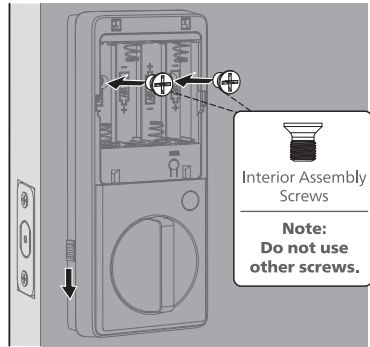

- 17 Install the AA alkaline batteries according to the direction guide inside the battery holder.

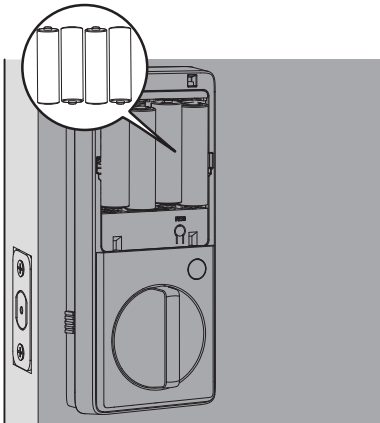

- 18 Press and hold the Reset Button for at least 5 seconds until you hear a beep. This activates the lock-handing process and must be completed before setting up the lock.

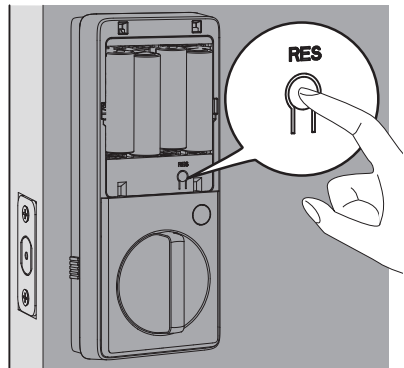

⚠ Attention

Ensure the cable is not pinched or the lock will not function properly.

Need help?



U.S.A. & Canada: +1(833)599-9111

Install the Door Position Sensor

Assembly View

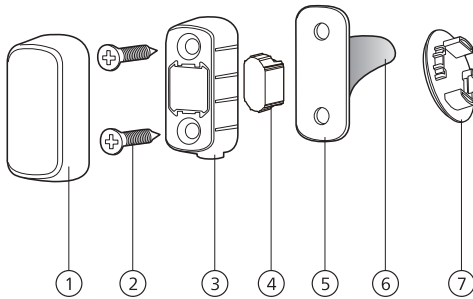

1	Cover
2	Door Position Sensor Mounting Screws (Optional) (2)
3	Mounting Housing
4	Magnet
5	Door Position Sensor Mounting Template
6	Mounting Tape
7	Door Position Sensor Cap (Optional)

How to Install

There are two ways to install the Door Position Sensor: **Surface Mount** and **Flush Mount**. Refer to the Door Position Sensor Mounting Template in the box for specific operations.

Surface Mount is recommended to install the Door Position Sensor.

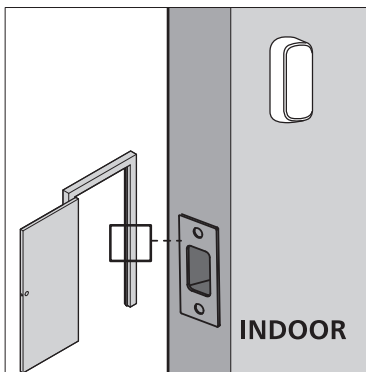

Surface Mount



Flush Mount

⚠ Attention

If you want to use the Door Position Sensor but prefer not to drill into the door frame, install the surface mounted Door Position Sensor using the Mounting Tape **ONLY**.

3 How to Setup

Download the Philips Home Access App



Scan the QR Code to download the Philips Home Access app.

Create a User Account

Register and log in to the Philips Home Access app.

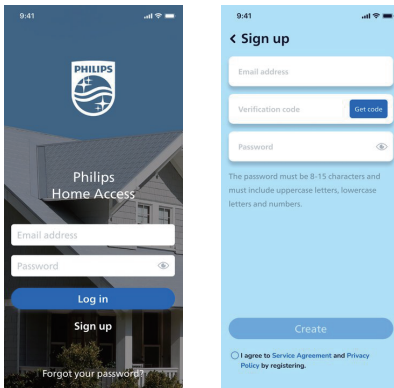

Add the Device

Enable Bluetooth on your phone and click the "Add device" button on the app.

Scan the QR Code or manually enter the ESN located on the back of the Battery Cover and complete the pairing steps following the in-app instruction.

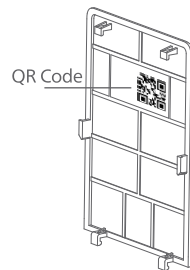

Calibrate the Door Position Sensor

Follow the instructions in the app until you have successfully calibrated your smart lock and the Door Position Sensor together.

Attention

The process of calibrating the Door Position Sensor should be carried out near the smart lock.

If the Philips Home Access app fails to calibrate the lock, check whether the Door Position Sensor has been installed correctly and try again.

4 How to Use

Feature Definitions

Master PIN Code

Required for programming and adjusting settings. The Master PIN Code can be used to unlock the deadbolt in Away Mode and Privacy Mode. The default Master PIN Code (12345678) must be changed immediately by programming on the lock (Programming instructions refer to page 17.) or changing it via the Phillips Home Access app after completing the installation. The owner/manager should keep this information confidential.

3 Ways to Unlock

Unlock with your PIN codes, keys, or a gentle touch on the Phillips Home Access app. The PIN codes can be added by programming on the lock (Programming instructions refer to page 17.) or setting it on the Phillips Home Access app.

Simple Sharing

Tap “add guest” on the Phillips Home Access app to share access with your family or friends. The access can only be shared and accepted via the Phillips Home Access app.

Lock Activities Insight

Offers a detailed record of all lock interactions and activities like lock/unlock events and user access. The records update whenever your smartphone is connected with the lock with Bluetooth, or update in real-time when equipped with the Phillips Wi-Fi Bridge (sold separately).

Temporary PIN Codes

Generate PIN codes remotely for guests or a service technician through the Phillips Home Access app. It can be a one-time PIN code that will be deleted upon use or a duration PIN code that will work repeatedly during a specific period of time.

One-Touch Locking

Lock the door by simply pressing and holding any key on the touchscreen for 2s.

Auto-Lock

The unit will automatically lock after it has been unlocked. This feature is disabled by default. It can be set on the lock for a time delay between 30 and 180 seconds (Programming instructions refer to page 19) or set between 10 and 180 seconds via the Phillips Home Access app.

Silent Mode

The sounds can be muted when pressing the keypad. However, you will still hear low battery warnings and system alerts. Enable it by programming on the lock (Programming instructions refer to page 19.) or setting it on the Phillips Home Access app.

Away Mode

This is a safety feature when you leave your house for a vacation or long trip. Away Mode restricts all user PIN codes until the Master PIN Code is entered on the keypad. When the lock is unlocked by the Thumb Turn, an alarm will sound for 1 minute. It will send a notification via the Philips Home Access app when equipped with the Philips Wi-Fi Bridge (sold separately).

Enable it by programming on the lock (Programming instructions refer to page 19.) or setting it on the Philips Home Access app.

By entering the Master PIN Code on the keypad or setting it on the Philips Home Access app, you can disable the alarm and the Away Mode.

Privacy Mode

Press and hold the Privacy Button on the interior assembly for 3 seconds to activate the Privacy Mode. This will restrict all User PIN Code access. Privacy Mode will be disabled automatically after unlocking the door with the Thumb Turn or the Master PIN Code.

Factory Reset & Default Settings

This procedure erases all user and network settings and unpairs the lock from users' accounts.

All paired accessories will also be removed. Restoring the lock will also activate the lock-handing process.

Press the Reset Button for at least 5 seconds until you hear the tone prompting you to restore the default settings.

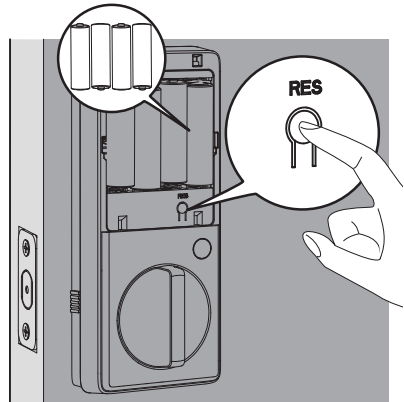

Function	Default Setting
Master PIN Code	12345678
Auto-Lock	Disabled
Silent Mode	Disabled
Shut Down Time	3 minutes
Away Mode	Disabled

Format of Entry Methods

1. Master PIN Code (4 to 10 digits): The default Master PIN Code is 12345678. Change the default Master PIN Code before programming other codes.
2. User PIN Code (4 to 10 digits): A total of 100 User PIN Codes can be programmed and stored in the lock.
3. Both Master and User PIN Codes do not support the following combination of numbers:

A. Forward number

A.

1	2	3	4	5	6	7	8
---	---	---	---	---	---	---	---

 ✕

B. Backward number

B.

8	7	6	5	4	3	2	1
---	---	---	---	---	---	---	---

 ✕

C. Repeated number

C.

2	2	2	2	2	2	2	2
---	---	---	---	---	---	---	---

 ✕

D. Contain existing code

D. If

5	6	8	3
---	---	---	---

 ✓

then

5	6	8	3	9	1
---	---	---	---	---	---

 ✕

and

9	1	5	6	8	3
---	---	---	---	---	---

 ✕

Program the Lock

⚠ Attention

The default Master PIN Code is 12345678. Change the default Master PIN Code before programming the lock. The indicator light will flash red when the code entered is not saved successfully.

If no button is pressed for more than 10 seconds, the lock will exit programming mode.

All programming can also be done through the Philips Home Access app.

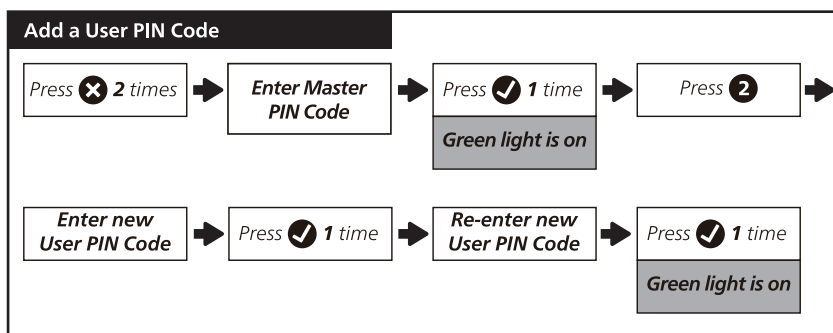
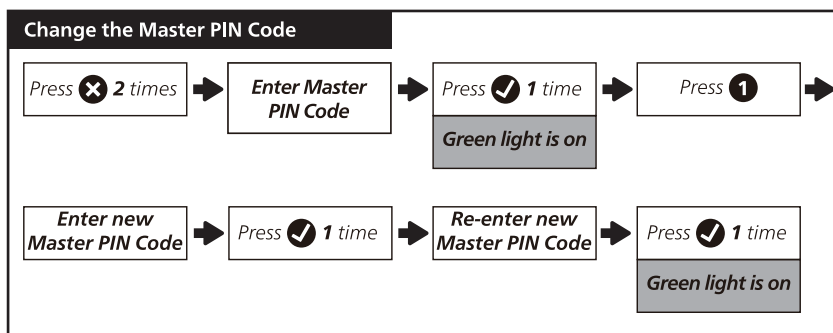
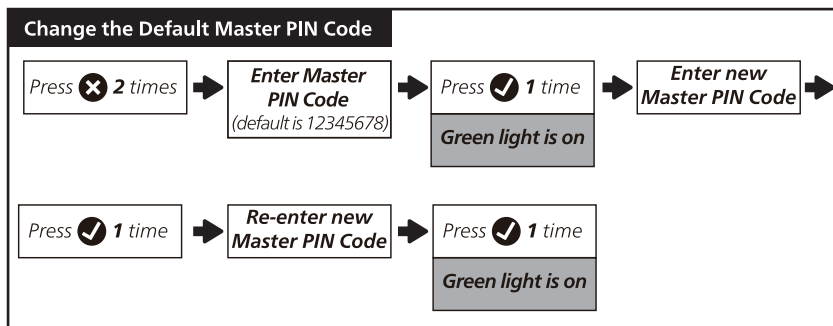

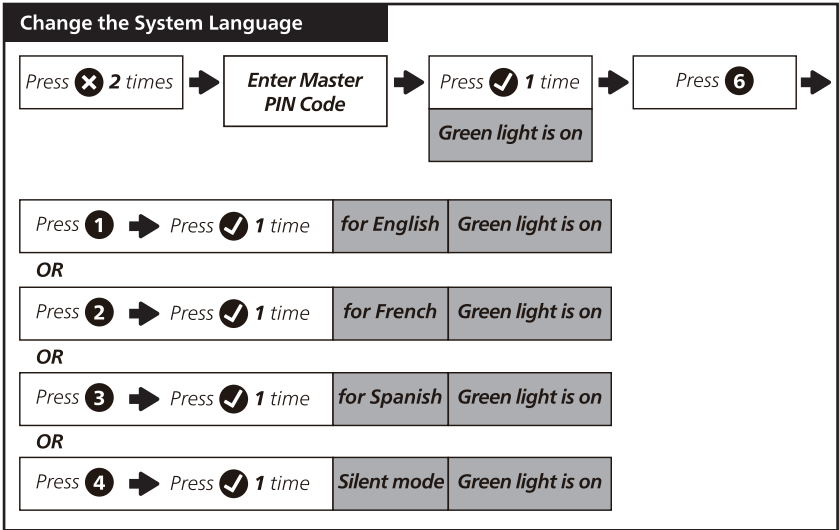
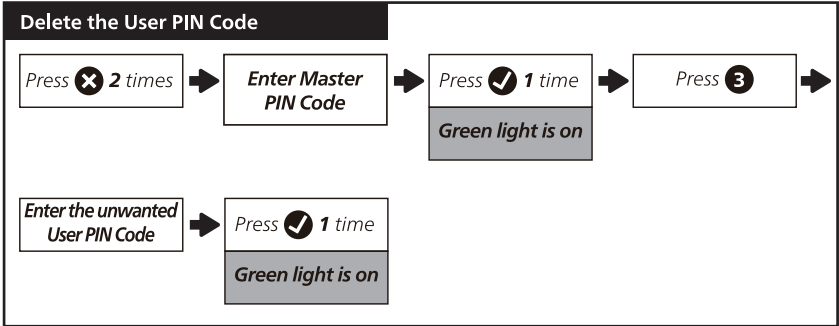

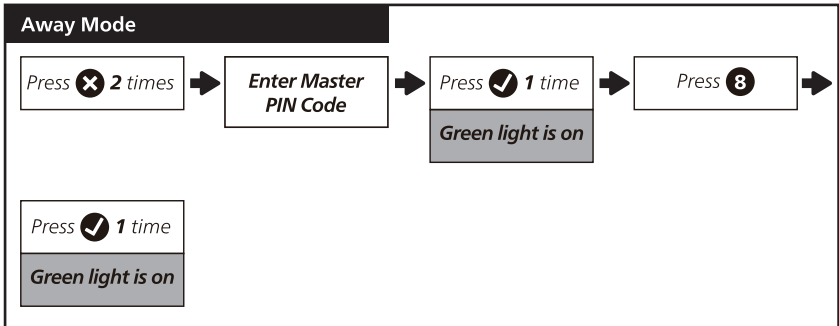
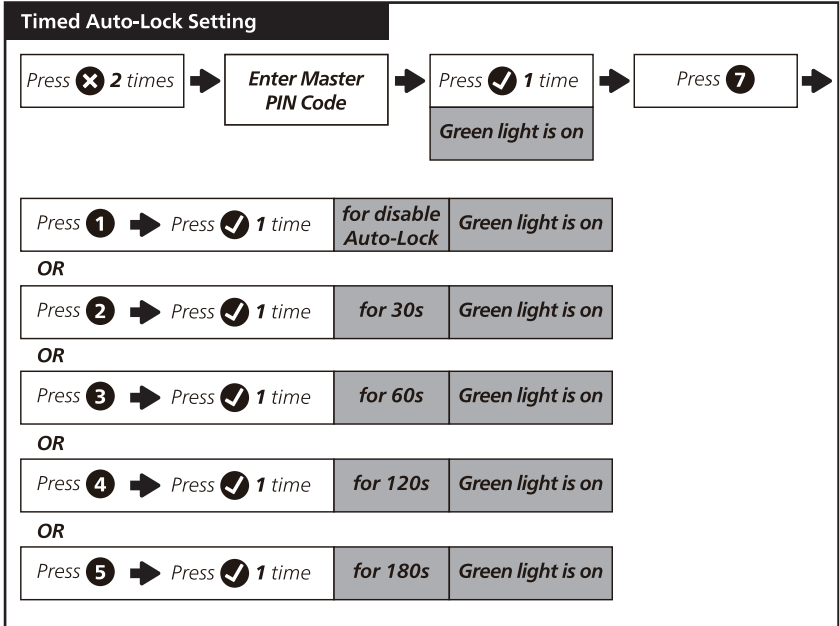

Lock & Unlock

Unlocking the Door from Outside

1. Unlock by PIN codes.
2. Unlock by Mechanical Key.
3. Unlock by the Philips Home Access app.

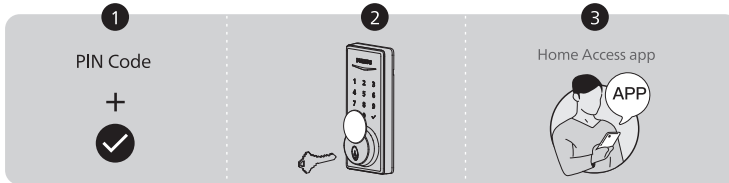

Unlocking the Door from Inside

1. Rotate the Thumb Turn to the unlock position.
2. Unlock by the Philips Home Access app.
3. Unlock by the Voice Assistant when equipped with the Philips Wi-Fi Bridge (sold separately).

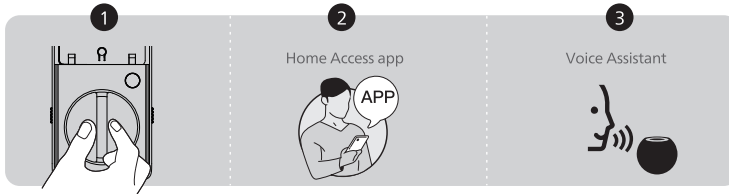

Locking the Door from Outside

1. Press and hold any button on the keypad for at least 2 seconds to lock the door in Manual Mode.
2. In Auto-Lock mode, the Latch Bolt will automatically extend after it is unlocked and the door is shut.
3. Lock by the Philips Home Access app.
4. Lock by the Mechanical Key.

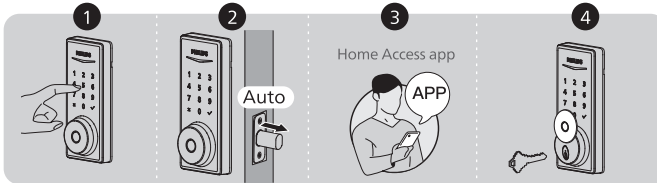

Locking the Door from Inside

1. Rotate the Thumb Turn to the locked position to lock the device in Manual Mode.
2. Press the Privacy Button to lock the device in Manual Mode.
3. In Auto-Lock Mode, the device is locked automatically.
4. Lock by the Philips Home Access app.
5. Lock by the Voice Assistant when equipped with the Philips Wi-Fi Bridge (sold separately).

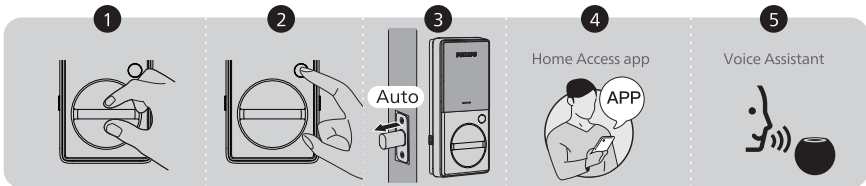

5 Troubleshooting

Issue	Solution
The Latch Bolt does not operate correctly after installation.	<ul style="list-style-type: none"> ◆ Make sure the backset on the Latch Bolt is set to the proper length. Refer to page 8. ◆ Make sure before installation the Latch Bolt is retracted. Refer to page 9. ◆ Please restore to the factory default setting and enter the default Master PIN Code to set up the lock. Refer to page 15.
After installation, the Latch Bolt makes sounds but does not work.	<p>Ensure you have followed the installation instructions. Re-install and reset the lock by paying attention to the following tips:</p> <ul style="list-style-type: none"> ◆ Before installing the Exterior and Interior Assembly, make sure the Latch Bolt is fully retracted (in the unlocked position). ◆ Do not insert the key when you are installing. ◆ Ensure you have inserted the cable connector of the Exterior Assembly to the socket on the Interior Assembly correctly. ◆ Keep the Exterior and Interior Assembly aligned and parallel to the door edge, and the Latch Bolt parallel to the door edge. ◆ Press and hold the Reset Button for at least 5 seconds until you hear a beep. ◆ Use new 4 AA dry batteries, do not use rechargeable batteries, or new batteries mixed with old batteries.
The door handing is not activated after the batteries are installed.	<ul style="list-style-type: none"> ◆ Press the Reset Button for at least 5 seconds until you hear the tone prompting you to restore the default settings.
The lock turns in the wrong direction.	<ul style="list-style-type: none"> ◆ Press and hold the Reset Button for at least 5 seconds until you hear a beep to activate the lock-handing process. ◆ If resetting fails to solve it, the lock is probably not installed correctly. Please re-install the lock and reset it again.
Cannot pull out the key from the Keyhole.	<ul style="list-style-type: none"> ◆ Disassemble the lock, then rotate to pull out the key and re-install the lock. ◆ Do not insert the key when you are installing.
The lock rotates only if the Key is inserted.	<ul style="list-style-type: none"> ◆ Make sure the Latch Bolt is installed correctly. Refer to page 8-9.
The lock does not smoothly lock or unlock while using the Thumb Turn.	<ul style="list-style-type: none"> ◆ Confirm the Mounting Screws are properly installed.

Issue	Solution
<p>The lock only locks but does not unlock, or the Latch Bolt goes in and out uncontrollably.</p>	<ul style="list-style-type: none"> ◆ If the door locks and unlocks smoothly in the open position, then there is a problem with the door frame. Make sure the hole in the door frame is drilled a minimum of 1"(25mm) deep to leave enough space for the deadbolt to extend into the door frame when the door is locked. ◆ If the issue still happens in the open position, then there is a problem with the lock handing or installation. Press and hold the Reset Button for at least 5 seconds until you hear a beep to reset the lock. If resetting fails to solve it, the lock is probably not installed correctly. Please re-install the lock and reset it again. ◆ If the solutions still cannot solve the problem, please feel free to contact us.
<p>Failed to lock.</p>	<ul style="list-style-type: none"> ◆ Keep the Exterior and Interior Assembly aligned and parallel to the door edge. ◆ Keep the Latch Bolt parallel to the door edge.
<p>The Master PIN Code cannot be changed.</p>	<ul style="list-style-type: none"> ◆ Restore factory settings and reprogram all user PIN codes. Refer to page 15-17.
<p>Failed to scan the QR Code on the device.</p>	<ul style="list-style-type: none"> ◆ Scan the QR Code in a well-lit environment, use the built-in flashlight on your phone, or try to scan in an environment with sufficient lighting. ◆ Ensure enough distance between your smartphone and the QR Code, and ensure the QR Code is at the center of your phone screen. ◆ Direct lighting or sunlight can cause reflections that will interfere with the scanning process.
<p>Failed to add the device via Bluetooth.</p>	<ul style="list-style-type: none"> ◆ Make sure your smart lock has enough power, and your phone is close to it. ◆ Check your phone's Bluetooth settings and ensure it's turned on. ◆ If you have an Android device, enable the Location Service.
<p>Failed to set up the lock.</p>	<ul style="list-style-type: none"> ◆ Make sure the lock is installed correctly. ◆ Insert fresh batteries and make sure that the cable is not pinched. ◆ After installation, reset the lock to factory settings to complete the lock setting process.
<p>I forgot my Master PIN Code.</p>	<ul style="list-style-type: none"> ◆ Perform a factory reset to clear all PIN codes. Once the reset is completed, all PIN codes will be deleted and the Master PIN Code will be reset to the default Master PIN Code of 12345678.

Issue	Solution
Receiving low battery alerts.	<ul style="list-style-type: none"> ◆ Remove the batteries and insert 4 new AA alkaline batteries.
The keypad is not responding.	<ul style="list-style-type: none"> ◆ Make sure batteries are inserted correctly. ◆ If the battery indicator flashes continuously, the batteries are low. Please replace them with 4 new AA alkaline batteries. ◆ Make sure that the cable is properly connected and has not been damaged during installation.
Auto-Lock is not working.	<ul style="list-style-type: none"> ◆ If the battery indicator flashes continuously, the batteries are low. Please replace them with 4 new AA alkaline batteries. ◆ Activate the Auto-Lock function. Refer to page 19 to set it on the lock or turn it on via the Philips Home Access app.
The Philips Home Access app displays that the door is open when the door is closed.	<ul style="list-style-type: none"> ◆ Re-calibrate your lock with the door position sensor in the Philips Home Access app. ◆ If re-calibration does not solve this problem, check to see if another magnet has been brought into the range of the lock. If so, remove it.

Still have questions or need help? Please feel free to contact us:



U.S.A. & Canada: +1(833)599-9111

6 Warranty

2 Years Warranty

For more information on the warranty applicable for this product, please visit www.philips.com or contact the dealer where you purchased the product.

7 FCC Statement

This equipment has been tested and found to comply with the limits for a Class B digital device, pursuant to part 15 of the FCC Rules. These limits are designed to provide reasonable protection against harmful interference in a residential installation. This equipment generates, uses and can radiate radio frequency energy and, if not installed and used in accordance with the instructions, may cause harmful interference to radio communications. However, there is no guarantee that interference will not occur in a particular installation. If this equipment does cause harmful interference to radio or television reception, which can be determined by turning the equipment off and on, the user is encouraged to try to correct the interference by one or more of the following measures:

- Reorient or relocate the receiving antenna.
- Increase the separation between the equipment and receiver.
- Connect the equipment into an outlet on a circuit different from that to which the receiver is connected.
- Consult the dealer or an experienced radio/TV technician for help.

Caution: Any changes or modifications to this device not explicitly approved by manufacturer could void your authority to operate this equipment.

This device complies with part 15 of the FCC Rules. Operation is subject to the following two conditions: (1) This device may not cause harmful interference, and (2) this device must accept any interference received, including interference that may cause undesired operation.

RF Exposure Information

This equipment complies with FCC radiation exposure limits set forth for an uncontrolled environment. This equipment should be installed and operated with minimum distance 20cm between the radiator and your body.

8 ISED Statement

English: This device contains licence-exempt transmitter(s)/receiver(s) that comply with Innovation, Science and Economic Development Canada's licence-exempt RSS(s). Operation is subject to the following two conditions:

- (1) This device may not cause interference.
- (2) This device must accept any interference, including interference that may cause undesired operation of the device.

The digital apparatus complies with Canadian CAN ICES-3 (B)/NMB-3(B).

French: Cet appareil contient des émetteurs/récepteurs exempts de licence qui sont conformes aux RSS exemptés de licence d'Innovation, Sciences et Développement économique Canada.

L'exploitation est soumise aux deux conditions suivantes:

- (1) Cet appareil ne doit pas provoquer d'interférences.
- (2) Cet appareil doit accepter toute interférence, y compris les interférences susceptibles de provoquer un fonctionnement indésirable de l'appareil.

L'appareil numérique du ciem conforme canadien peut-3 (b) / nmb-3 (b).

This device meets the exemption from the routine evaluation limits in section 2.5 of RSS 102 and compliance with RSS 102 RF exposure, users can obtain Canadian information on RF exposure and compliance.

cet appareil est conforme à l'exemption des limites d'évaluation courante dans la section 2.5 du cnr - 102 et conformité avec rss 102 de l'exposition aux rf, les utilisateurs peuvent obtenir des données canadiennes sur l'exposition aux champs rf et la conformité.

This equipment complies with Canada radiation exposure limits set forth for an uncontrolled environment.

Cet équipement est conforme aux limites d'exposition aux rayonnements du Canada établies pour un environnement non contrôlé.

This equipment should be installed and operated with minimum distance 20cm between the radiator & your body.

Cet équipement doit être installé et utilisé à une distance minimale de 20 cm entre le radiateur et votre corps.



Philips and the Philips Shield Emblem are registered trademarks of Koninklijke Philips N.V. and are used under license. This product has been manufactured by and is sold under the responsibility of Shenzhen Conex Intelligent Technology Co., Ltd. and Shenzhen Conex Intelligent Technology Co., Ltd. is the warrantor concerning this product.