

Register your product and get support at
www.philips.com/welcome

PhotoFrame

SPF2307
SPF2327



EN User manual

PHILIPS

Contents

1 Important	4
Safety	4
Notice	4
Banned Substance Declaration	6
Class II statement	6

2 Your PhotoFrame	7
Introduction	7
What's in the box	7
Overview of your PhotoFrame	8

3 Get started	9
Install the stand	9
Connect power	9
Turn on the PhotoFrame	10
Transfer media	11
Know these keypad icons	12

4 Display photos	13
Manage slideshow and photos	13
Zoom and crop a photo	14

5 Browse	15
Browse and manage albums and media	15

6 Clock	18
Display the clock	18
Clock menu	18

7 Message	19
Create a message	19
Edit a message	20
View a message	22

8 Settings	23
Select an on-screen language	23
Adjust brightness	23
Set time/date	24
Set SmartPower timer	25
Hibernate the PhotoFrame	26
Set auto orientation	26
Turn button sound on/off	27
Slideshow setting	27
View information of the PhotoFrame	30
Reset all settings to factory default	30

9 Upgrade the PhotoFrame	31
---------------------------------	----

10 Product information	32
-------------------------------	----

11 Frequently asked questions	34
--------------------------------------	----

12 Glossary	35
--------------------	----

Need help?

Please visit www.philips.com/welcome where you can access a full set of supporting materials such as user manual, the latest software updates and answers to frequently asked questions.

1 Important

Safety

Safety precautions and maintenance

- Never touch, push, rub or strike the screen with hard objects as this may damage the screen permanently.
- When the product is not used for long periods, unplug it.
- Before you clean the screen, turn off and unplug the power cord. Only clean the screen with a soft, water-damp cloth. Never use substances such as alcohol, chemicals or household cleaners to clean the product.
- Never place the product near naked flames or other heat sources, including direct sunlight.
- Never expose the product to rain or water. Never place liquid containers, such as vases, near the product.
- Never drop the product. When you drop the product, it will be damaged.
- Ensure that you install and use services or software only from trustworthy sources free of virus or harmful software.
- This product is designed for indoor use only.
- Only use the supplied power adaptor for the product.
- The socket-outlet shall be installed near the equipment and shall be easily accessible.

Notice

Warranty

No components are user serviceable. Do not open or remove covers to the inside of the product. Repairs may only be done by Philips Service Centres and official repair shops.

Failure to do so shall void any warranty, stated or implied.

Any operation expressly prohibited in this manual, any adjustments, or assembly procedures not recommended or authorised in this manual shall void the warranty.



This product is in compliance with the essential requirements and other relevant provisions of Directives 2006/95/EC (Low Voltage), 2004/108/EC (EMC).

Respect copyrights



The making of unauthorized copies of copy-protected material, including computer programs, files, broadcasts and sound recordings, may be an infringement of copyrights and constitute a criminal offence. This equipment should not be used for such purposes.

End of life disposal

- Your new product contains materials that can be recycled and reused. Specialized companies can recycle your product to increase the amount of reusable materials and to minimize the amount to be disposed of.
- Please find out about the local regulations on how to dispose your old monitor from your local Philips dealer.
- (For customers in Canada and U.S.A.) Dispose the old product in accordance to local-state and federal regulations.

For additional information on recycling contact www.eia.org (Consumer Education Initiative).

Recycling Information for Customers

Philips establishes technically and economically viable objectives to optimize the environmental performance of the organization's product, service and activities. From the planning, design and production stages, Philips emphasizes the importance of making products that can easily be recycled. At Philips, end-of-life management primarily entails participation in national take-back initiatives and recycling programs whenever possible, preferably in cooperation with competitors.

There is currently a system of recycling up and running in the European countries, such as The Netherlands, Belgium, Norway, Sweden and Denmark.

In U.S.A., Philips Consumer Lifestyle North America has contributed funds for the Electronic Industries Alliance (EIA) Electronics Recycling Project and state recycling initiatives for end-of-life electronics products from household sources. In addition, the Northeast Recycling Council (NERC) - a multi-state non-profit organization focused on promoting recycling market development - plans to implement a recycling program.

In Asia Pacific, Taiwan, the products can be taken back by Environment Protection Administration (EPA) to follow the IT product recycling management process, detail can be found in web site www.epa.gov.tw.

Environmental information



Your product is designed and manufactured with high quality materials and components, which can be recycled and reused.

When you see the crossed-out wheel bin symbol attached to a product, it means the product is covered by the European Directive 2002/96/EC:



Never dispose of your product with other household waste. Please inform yourself about the local rules on the separate collection of electrical and electronic products. The correct disposal of your old product helps prevent potentially negative consequences on the environment and human health.

North Europe Information (Nordic Countries)

VARNING:

FÖRSÄKRA DIG OM ATT HUVUDBRYTARE OCH UTTAG ÄR LÄTÅTKOMLIGA, NÄR DU STÄLLER DIN UTRUSTNING PÅPLATS.
Placering/Ventilation

ADVARSEL:

SØRG VED PLACERINGSFOR, AT NETLEDNINGENS STIK OG STIKKONTAKT ER NEMT TILGÆNGELIGE.
Paikka/Ilmankierto

VAROITUS:

SIJOITA LAITE SITEN, ETTÄ VERKKOJOHTO VOIDAAN TARVITTAESSA HELPOSTI IRROTTAA PISTORASIESTA.
Plassering/Ventilasjon

ADVARSEL:

NÅR DETTE UTSTYRET PLASSERES, MÅ DU PASSE PÅ AT KONTAKTENE FOR STØMTILFØRSEL ER LETTE Å NÅ.

Banned Substance Declaration

This product complies with RoHs and Philips BSD (AR17-G04-5010-010) requirements.

Class II statement

Class II equipment symbol:



This symbol indicates that this product has a double insulation system.

Norge

Typeskilt finnes på apparatens underside.

Observer: Nettbryteren er sekundert innkoplet.

Den innebygde nettdelen er derfor ikke frakoplet nettet så lenge apparatet er tilsluttet nettkontakten.

For å redusere faren for brann eller elektrisk støt, skal apparatet ikke utsettes for regn eller fuktighet.

2 Your PhotoFrame

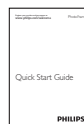

Congratulations on your purchase, and welcome to Philips! To fully benefit from the support that Philips offers, register your product at www.philips.com/welcome.

- Quick start guide

Introduction

With this Philips Digital PhotoFrame, you can use the PhotoFrame to:

- Display JPEG photos
- Create gift messages

What's in the box

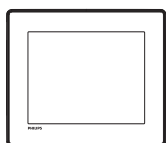

- Philips Digital PhotoFrame



- Stand









- AC-DC power adaptor

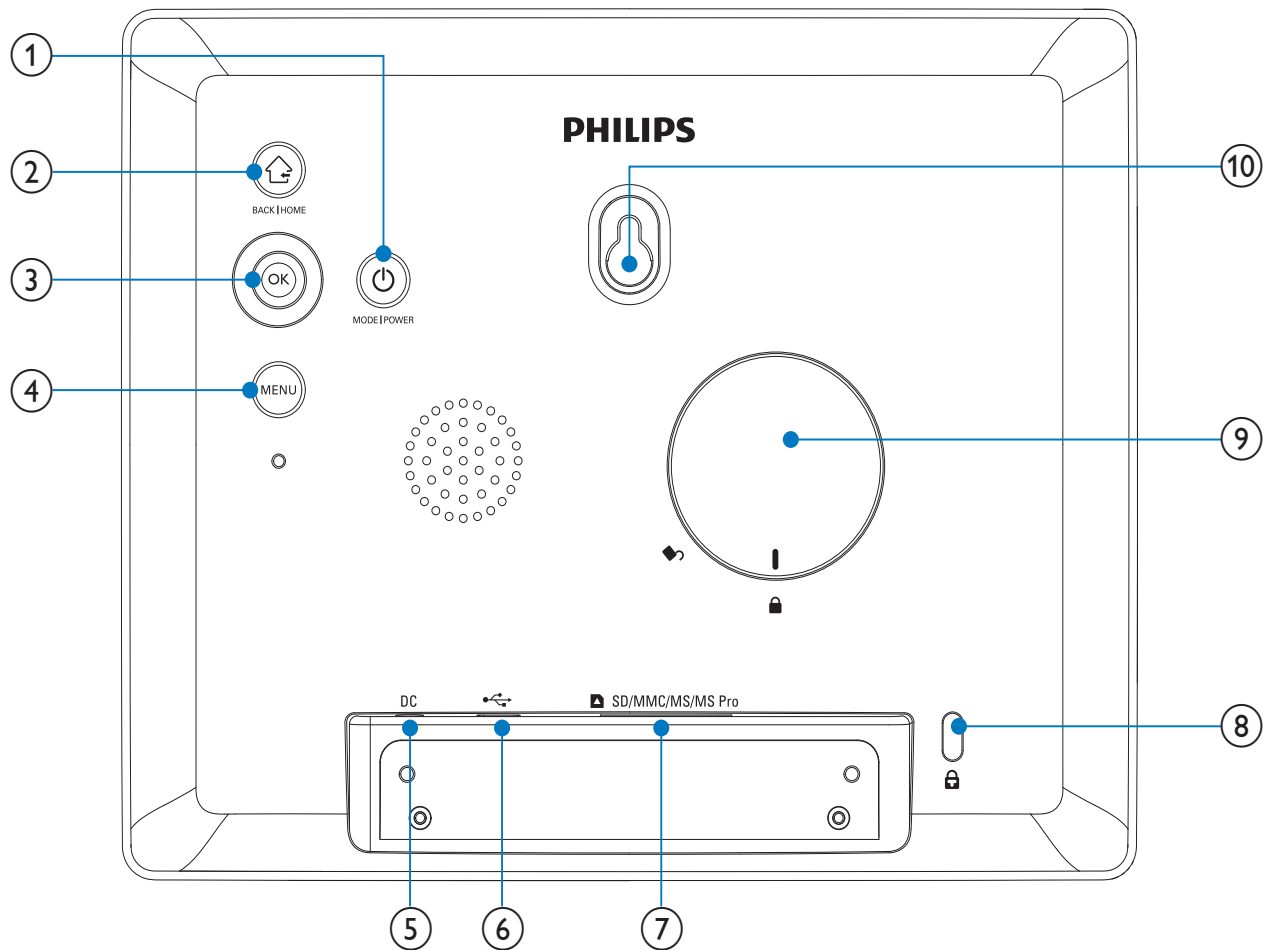

- CD-ROM with User manual

Overview of your PhotoFrame



- | | |
|---|--|
| <p>① </p> <ul style="list-style-type: none"> • Press to switch mode: slideshow/clock/calendar • Hold to turn on/off the PhotoFrame <p>② </p> <ul style="list-style-type: none"> • Press to go back • Hold to go to the home screen <p>③ OK (Joystick)</p> <ul style="list-style-type: none"> • Press to confirm a selection • Press to pause or resume play • Move up/down/left/right to select the upper/lower/right/left option <p>④ MENU</p> <ul style="list-style-type: none"> • Press to enter/exit the menu <p>⑤ DC</p> <ul style="list-style-type: none"> • Socket for the AC-DC power adaptor | <p>⑥ </p> <ul style="list-style-type: none"> • Slot for a USB cable to PC <p>⑦  SD/MMC/MS/MS Pro</p> <ul style="list-style-type: none"> • Slot for an SD/MMC/MS/MS Pro card <p>⑧  Kensington lock</p> <p>⑨ Stand hole</p> <p>⑩ Wall mounting hole</p> |
|---|--|

3 Get started

! Caution

- Use the controls only as stated in this user manual.

Always follow the instructions in this chapter in sequence.

If you contact Philips, you will be asked for the model and serial number of this apparatus. The model number and serial number are on the back of the apparatus. Write the numbers here:
Model No. _____
Serial No. _____

Install the stand

To place the PhotoFrame on a flat surface, attach the supplied stand to the back of the PhotoFrame.

- 1 Insert the stand into the PhotoFrame and position the indication on the stand to the  position.

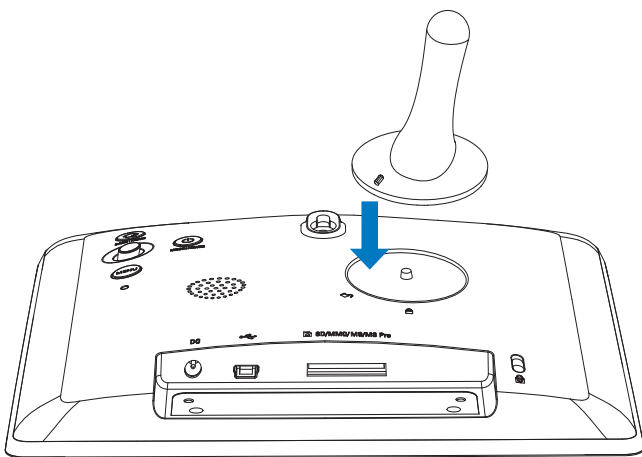

- 2 Turn the stand anti-clockwise 45 degrees to the  position and lock it to the PhotoFrame firmly.

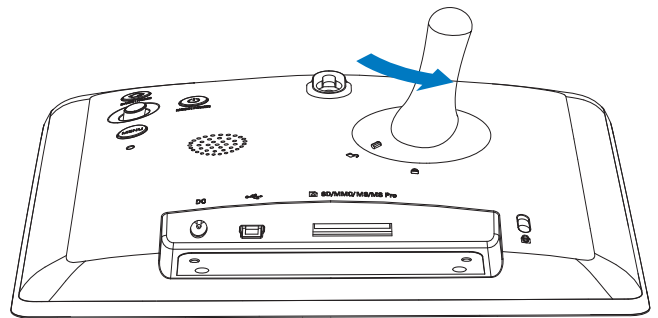

Connect power

≡ Note

- When you position the PhotoFrame, ensure that the power plug and outlet are easily accessible.

- 1 Connect the power cord to the **DC** socket of the PhotoFrame.

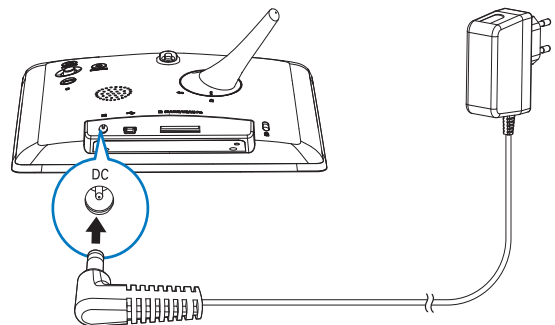

- 2 Connect the power cord to a power supply socket.

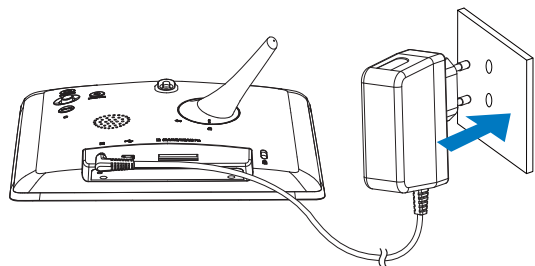

↳ A few seconds later, the PhotoFrame turns on automatically.

Turn on the PhotoFrame

Note

- When you connect the PhotoFrame to a power supply, the PhotoFrame turns on automatically.

- 1 When the PhotoFrame is turned off and connected to the power supply, hold Φ to turn on the PhotoFrame.

For the first time you turn on the PhotoFrame:

- The screen prompts you to select a language.



- Select a language, and then press **OK**.



- The screen prompts you to set time and date.



- Move the joystick to set time and date, and then press **OK**.

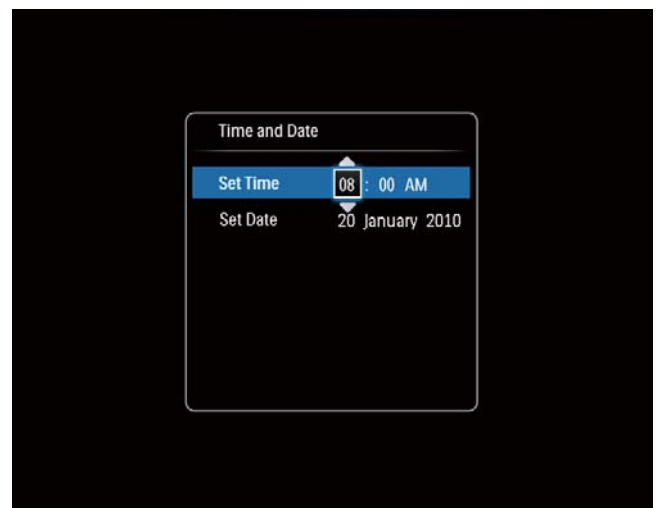

Tip

- If the PhotoFrame is disconnected from the power supply for a long time, you need set time and date again after you turn on the PhotoFrame.

Turn off the PhotoFrame

Note

- You can only turn off the PhotoFrame after all copy and save actions are complete.
- To turn off the PhotoFrame, press and hold Φ for about 2 seconds.

Transfer media

Transfer photos with a storage device

! Caution

- Do not disconnect the storage device from the PhotoFrame during media transfer.

The PhotoFrame supports most types of the following storage device:

- Secure Digital (SD)
- Secure Digital High Capacity (SDHC)
- Multimedia Card (MMC)
- Memory Stick (MS)
- Memory Stick Pro (MS Pro) (with adaptor)

- 1 Insert a storage device into the PhotoFrame.
↳ An option menu is displayed.



[Play Photos]: Select it to play media on the storage device

[Browse]: Select it to browse media on the storage device

[Copy to PhotoFrame]: Select it to start transfer operation

- 2 Select **[Copy to PhotoFrame]**, and then press **OK**.
↳ A confirmation message is displayed.

To copy photos to the PhotoFrame:

- 1 Select **[Yes]**, and then press **OK**.

- To remove a storage device, pull it out of the PhotoFrame.

Transfer photos with a computer

! Caution

- Do not disconnect the PhotoFrame from the computer during media transfer.

- 1 Connect a USB cable to the PhotoFrame and to the computer.

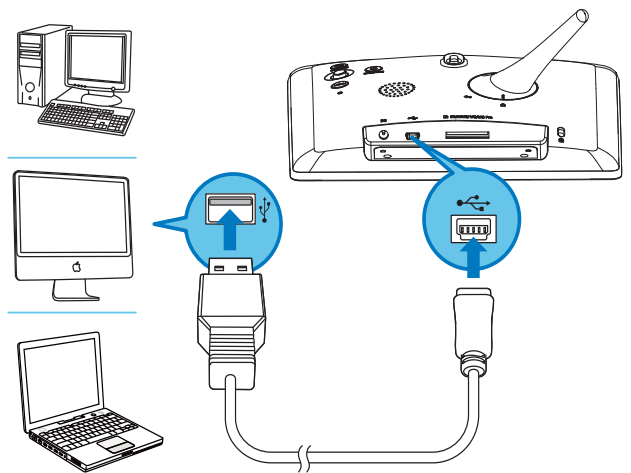









- ↳ You can drag and drop the media from the computer to an album on the PhotoFrame.

- 2 When the transfer is complete, disconnect the USB cable from the computer and the PhotoFrame.

* Tip

- You can transfer media from the PhotoFrame to a computer.
- The transfer speed depends the operating system and the software configuration of the computer.

Know these keypad icons

	Input in English
	Input in supported European languages
	Input in Simplified Chinese
	Input in Russian
	Switch to select symbols, punctuations, alphabet or numbers
	Switch between upper and lower case
	Enter a blank space
	Enter a line break

4 Display photos

Note

- You can display JPEG photos in slideshow mode on the PhotoFrame.

- 1 In the home screen, select **[Play]**, and then press **OK**.



- ↳ Photos are displayed in slideshow mode.

In slideshow mode:

- To pause the slideshow, press **OK**.
- To resume the slideshow, press **OK** again.
- To select the previous/next photo, move the joystick to the left/right.
- To view photos in filmstrip mode, move the joystick up.

In filmstrip mode:

- To select the previous/next photo, move the joystick to the left/right.
- To return to slideshow mode, press **OK**.

Tip

- During collage slideshow, photos are displayed randomly.

Manage slideshow and photos

You can take the following steps to manage the photo in slideshow mode or the slideshow settings:

- 1 Press **MENU**.
↳ An option menu is displayed.

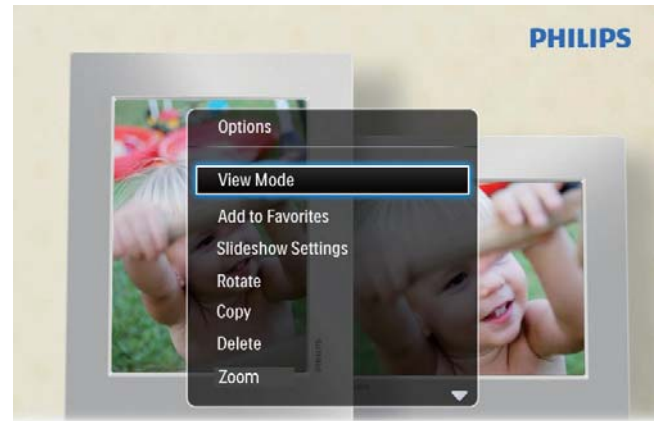

Automatic tilting. Goes whichever way you want it
Inclinaison automatique, dans le sens de votre choix

- 2 Select an option, and then press **OK**.
 - **[View Mode]**: Select the view mode
 - **[Add to Favorites]**: Add the photo to the **[Favorites]** album on the PhotoFrame
 - **[Slideshow Settings]**
 - **[Interval]**: Set the interval in slideshow
 - **[Shuffle]**: Play media randomly or not
 - **[Color Tone]**: Select the color for the photo
 - **[Transition Effect]**: Select the transition effect
 - **[Background Color]**: Select the background color
 - **[Rotate]**: Select an orientation to rotate the photo
 - **[Copy]**: Copy the photo to another album
 - **[Delete]**: Delete the photo
 - **[Zoom]**: Zoom and crop a photo
 - **[Brightness]**: Move the joystick up/down to adjust the brightness of display

Zoom and crop a photo

With the PhotoFrame, you can zoom in a photo, crop it, and save it as a new photo.

- 1 In slideshow mode, press **MENU**.
↳ An option menu is displayed.
- 2 Select [**Zoom**].



- 3 Press **OK** repeatedly to zoom in the photo (or exit the zoom mode).
- 4 Move the joystick to pan the photo.
- 5 Press **MENU**.
- 6 Select [**Crop and Save**], and then press **OK**.

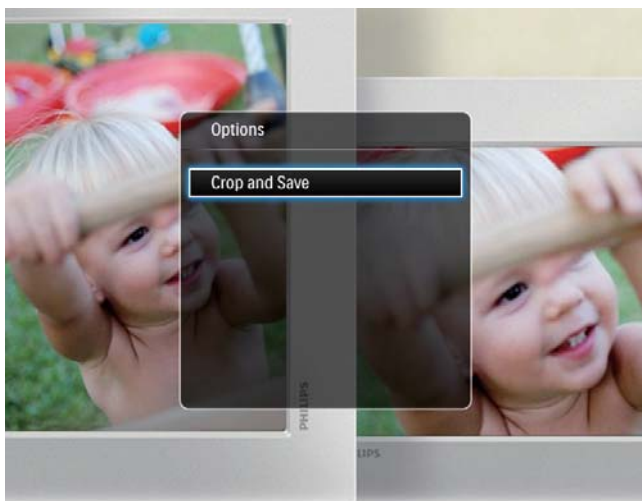

↳ A confirmation message is displayed.

- 7 Select [**Yes**], and then press **OK**.
 - To cancel the operation, select [**No**] and then press **OK**.

- 8 Select a location to save the new photo, and then press **OK**.

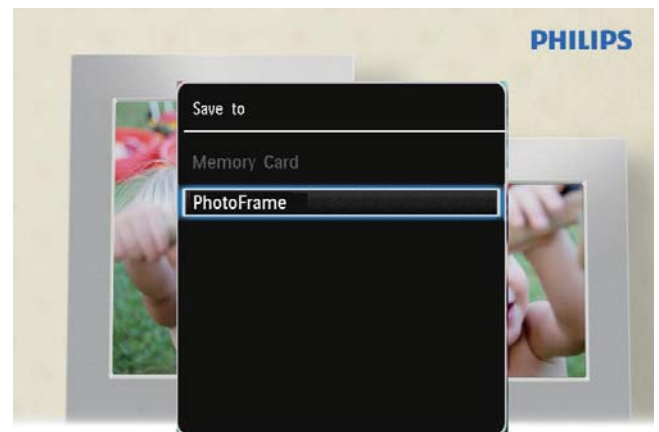

Automatic tilting. Goes whichever way you want it.
Inclinaison automatique, dans le sens de votre choix

- ↳ After the photo is saved, the PhotoFrame goes back to the slideshow mode.

5 Browse

Browse and manage albums and media

You can browse and manage albums and media in wave mode or album mode.

- **Wave mode:**

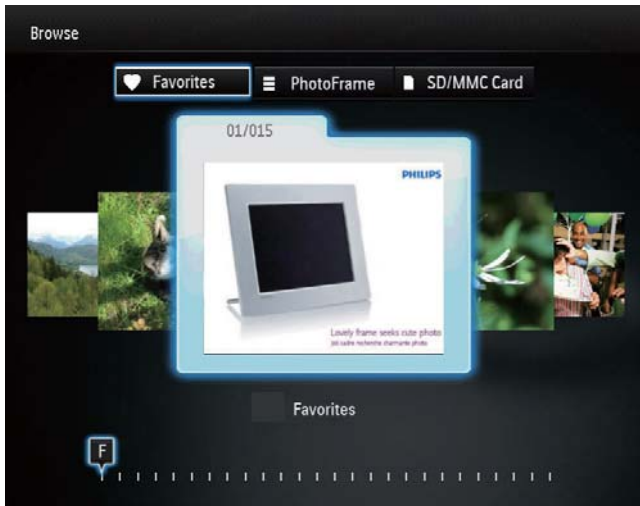

- **Album mode:**



Browse albums:

- 1 In the home screen, select **[Browse]** and then press **OK**.



↳ Albums are displayed in wave mode.

- **To access album mode**, press **⏏**.
 - **To return to wave mode**, press **⏏**.
- In wave/album mode,
 - Press **OK** once: A photo is displayed in pause mode.
 - Press **OK** twice: Slideshow is started.

Manage albums and media:

- 1 Select an album/device, press **MENU**.
 - ↳ An option menu is displayed.
- 2 Select an option, and then press **OK** to continue.

Album menu:



- **[Add to Favorites]**: Add media in the album to the **[Favorites]** album
- **[Create New Album]**: Create an album

- **[Copy]**: Copy media in the album to another album
- **[Move]**: Move media in the album to another album
- **[Delete]**: Delete media in the album
- **[Rename]**: Rename the album
- **[Multiple-select]**: Select multiple photos to manage

Thumbnail photo menu:



- **[Add to Favorites]**: Add media in the album to the **[Favorites]** album
- **[Copy]**: Copy media in the album to another album
- **[Move]**: Move media in the album to another album
- **[Delete]**: Delete media in the album
- **[Rotate]**: Rotate the photo in the album
- **[Color Tone]**: Select a color for the photo
- **[Multiple-select]**: Select multiple photos to manage

When you select the **[Favorites]** album, a different menu is displayed.

- **[Delete]**: Delete media in the album
- **[Copy]**: Copy media in the album to another album

Add media to the favorite album

To add media in the album to the **[Favorites]** album:

- 1 Select **[Add to Favorites]**, and then press **OK**.

Create an album

- 1 Select **[Create New Album]**, and then press **OK**.
- 2 To enter the name (about 24 characters), select an alphabet/number and then press **OK**.
 - To switch between uppercase and lowercase, select **aA** on the displayed keypad and then press **OK**.
- 3 When the name is complete, select **✓** and then press **OK**.
- 4 Press **OK** to start the saving process.

Copy media

- 1 Select **[Copy]**, and then press **OK**.
- 2 Select a destination album, and then press **OK** to start copy.

Move media

- 1 Select **[Move]**, and then press **OK**.
- 2 Select a destination album, and then press **OK** to start move.

Delete media

- 1 Select **[Delete]**, and then press **OK**.
 - ↳ A confirmation message is displayed.
- 2 Select **[Yes]**, and then press **OK** to start deletion.
 - To cancel the operation, hold **⇧**.

Rename an album

- 1 Select **[Rename]**, and then press **OK** to confirm.
↳ A keypad is displayed.
- 2 Move the joystick downwards twice to enter the keypad.
- 3 To enter the name (about 24 characters), select an alphabet/number and then press **OK**.
 - To switch between uppercase and lowercase, select **aA** on the displayed keypad and then press **OK**.
- 4 When the name is complete, select **✓** and then press **OK**.

Select multiple photos to manage

- 1 Select **[Multiple-select]**, and then press **OK**.
- 2 Select media.
 - To select all media in the album, press **OK**.
 - To select some of the media: Move the joystick and press **OK** to select a medium. Then repeat this step to select others.
 - To de-select a medium, select it and then press **OK** again.
- 3 After selection is complete, press **MENU** to continue.
↳ An option menu is displayed.



- 4 Select an option to continue.
 - **[Add to Favorites]**: Add the selected media to the **[Favorites]** album
 - **[Copy]**: Copy the selected media to another album
 - **[Move]**: Move the selected media to another album
 - **[Delete]**: Delete the selected media
 - **[Rotate]**: Rotate the selected media
 - **[Play Slideshow]**: Play the selected media in slideshow mode

Rotate photos

- 1 Select **[Rotate]**, and then tap **OK**.
- 2 Tap **◀/▶** to rotate the photo, and then tap **OK**.

6 Clock

Display the clock

- 1 In the home screen, select **[Clock]** and then press **OK**.



↳ A clock/calendar is displayed.

Clock menu

- 1 When a clock/calendar is displayed, press **MENU** to enter the clock menu.

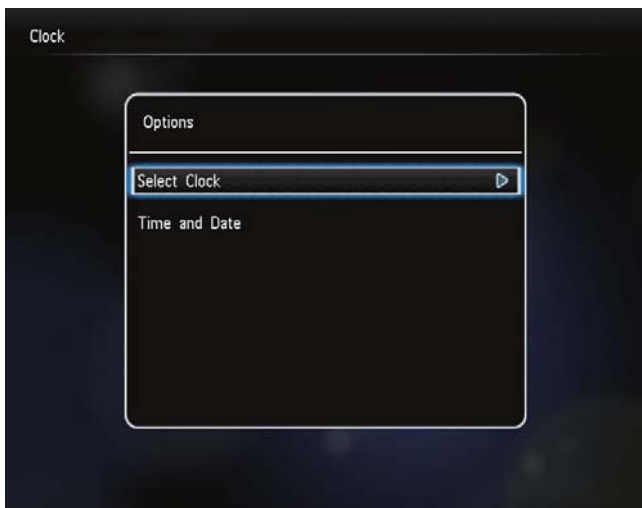



- **[Select Clock]**: Move the joystick left/right to select another clock or calendar to be displayed.

- **[Time and Date]**: Move the joystick up/down/left/right to set time/date or to select a time/date format. For details, see Section "Settings - Set time and date".

Select a clock/calendar style

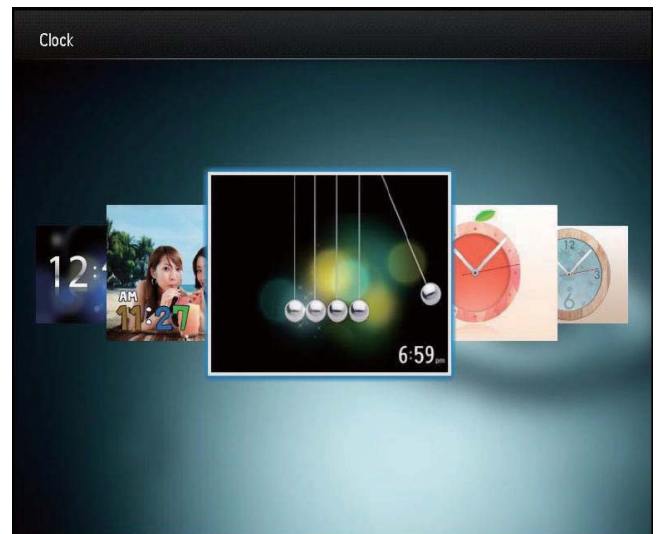
- 1 In the clock menu, select **[Select Clock]** and then press **OK**.
- 2 Move the joystick left/right to select a clock or calendar template, and then press **OK**.



- To go back to the home screen, hold .

7 Message

Create a message

- 1 In the home screen, select **[Message]** and then press **OK**.



- 2 Select **[Add a message to your photo]**, and then press **OK**.

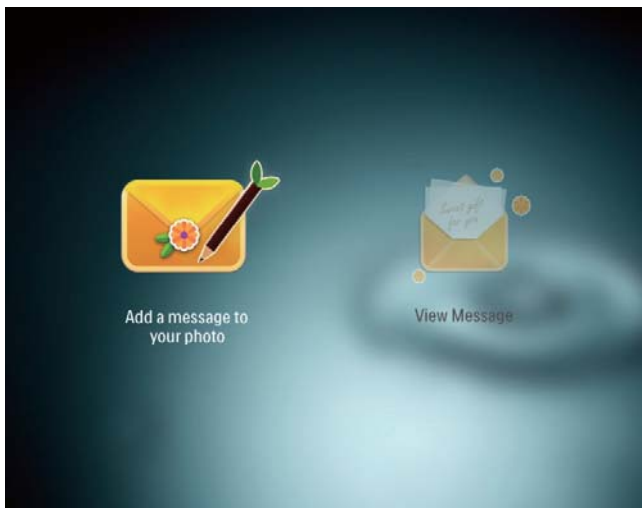

- 3 Move the joystick right or left to select a message template, and then press **OK**.

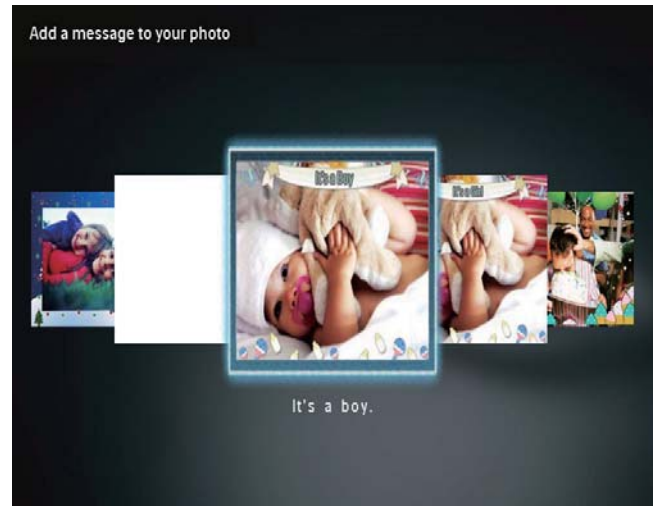

- Edit the text of the message or change image of the message.

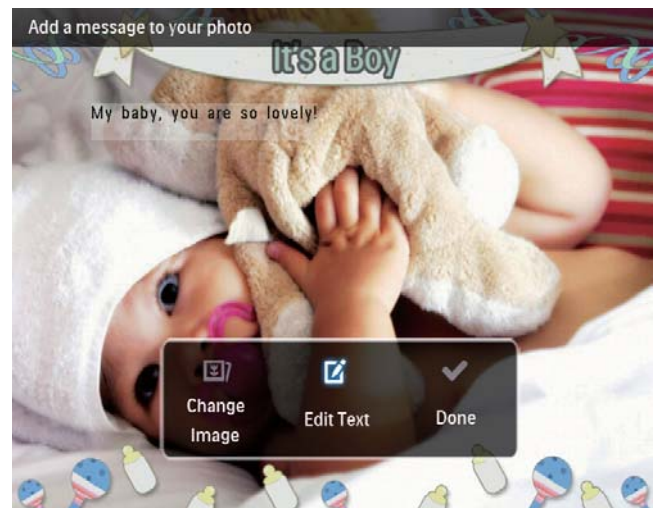

- Set the real time and date if applicable.

- 4 Select **[Done]**.
↳ The screen prompts you to schedule the message.
- 5 Schedule the message.

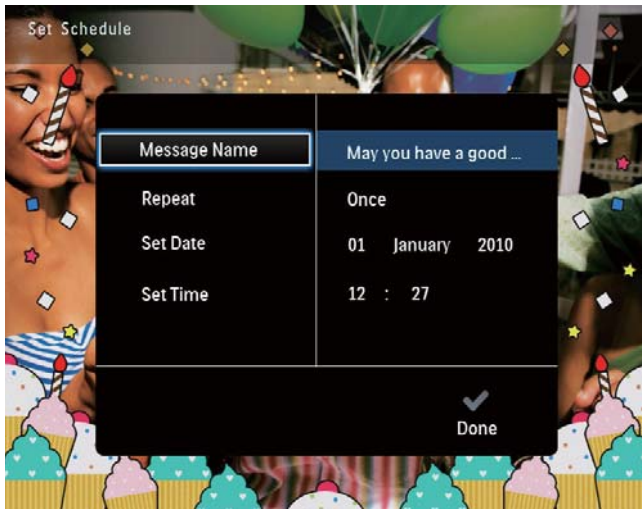

- **[Message Name]:** Enter the name. For details, see “Enter the name of a message”.
- **[Repeat]:** Select a repeat frequency
- **[Set Date]:** Set the date or day
- **[Set Time]:** Set the time

6 After you complete the message, select **[Done]** and press **OK**.

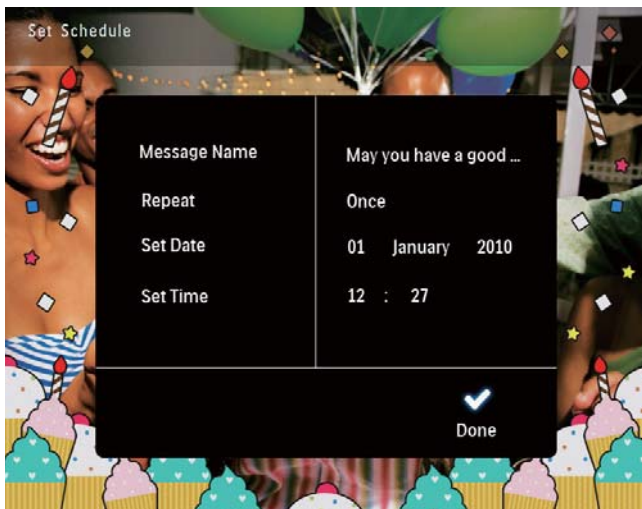

- To view the available messages, select **[View Message]**.

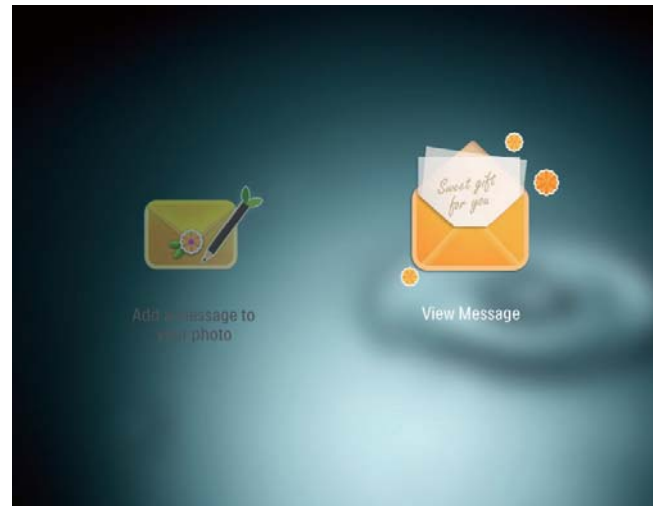

- To go back to the home screen, hold **⏪**.

Enter the name of a message

- 1 Select **[Message Name]**, and then press **OK**.
- 2 Move the joystick downward twice to enter the keypad.
- 3 To enter the name (about 24 characters), select an alphabet/number and then press **OK**.
 - To switch between uppercase and lowercase, select **aA** on the displayed keypad and then press **OK**.
- 4 When the name is complete, select **✓** and then press **OK**.

Edit a message

- 1 In the home screen, select **[Message]** and then press **OK**.



- **[Change Image]**: Change the photo of the message
- **[Edit Text]**: Edit the message text

To change the photo of a message:

- 1 Select **[Change Image]**, and then press **OK**.

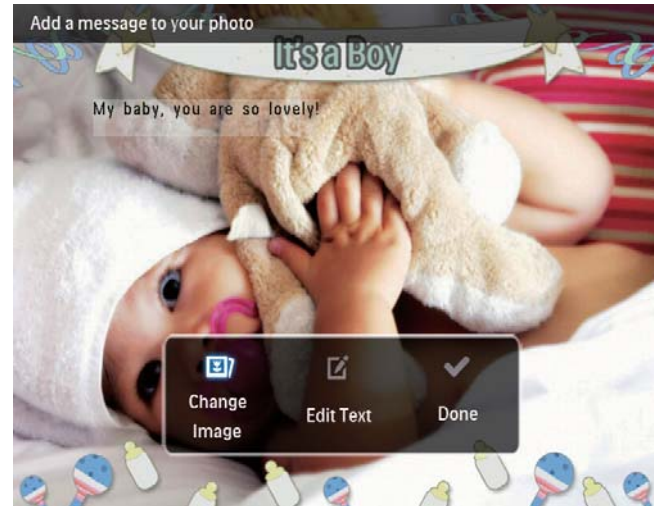

- 2 Select a photo available on the PhotoFrame, and then press **OK**.

To edit the text of a message:

- 1 Select **[Edit Text]**, and then press **OK**.

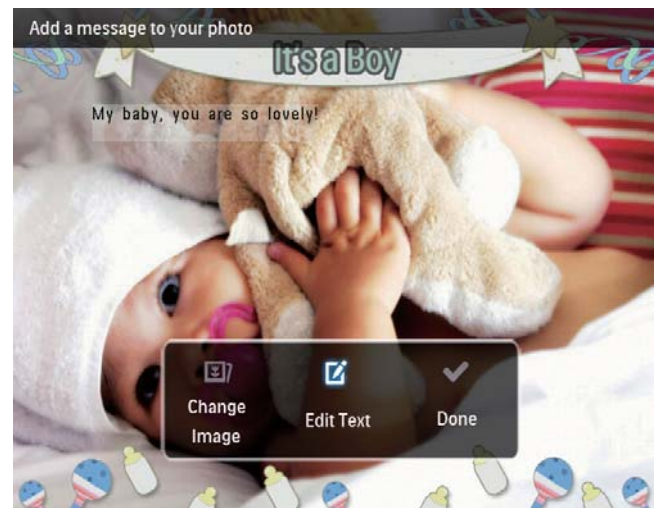

- 2 Select a preset template, and then press **OK**.
↳ The keypad is displayed.

- 2 Select **[Add a message to your photo]**, and then press **OK**.

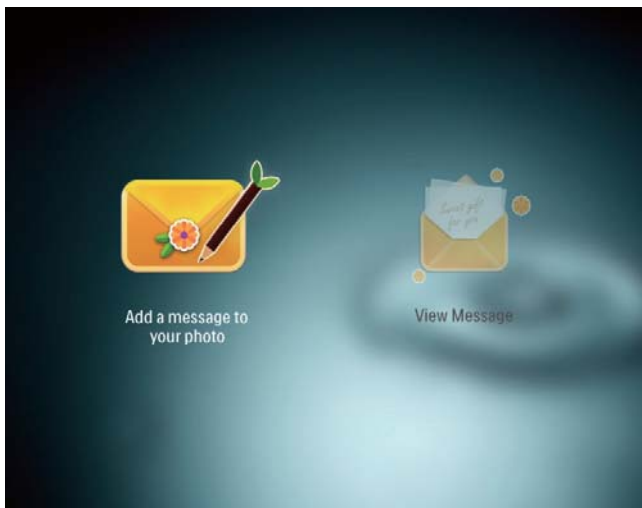

- 3 Move the joystick right or left to select a message template, and then press **OK**.

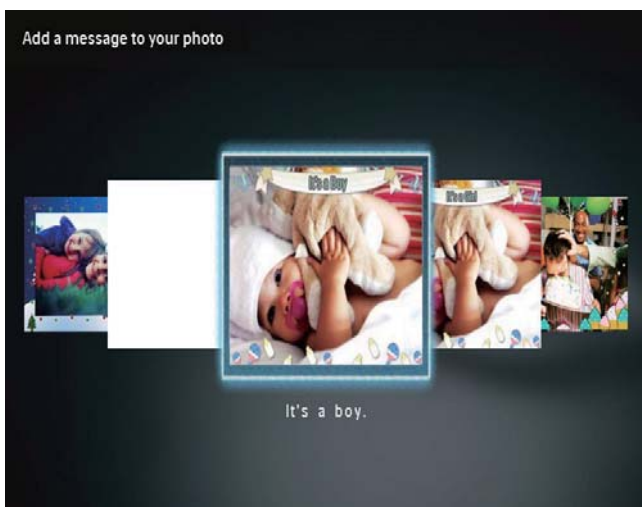

- 4 Move the joystick to select one of the following options to edit a message.

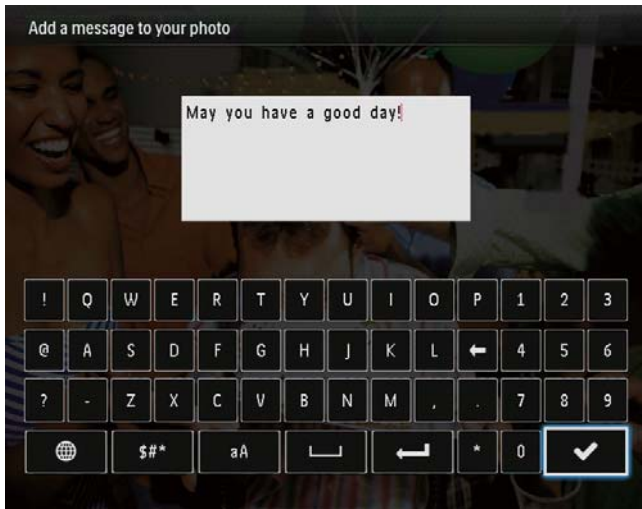

- 3 Move the joystick downwards twice to enter the keypad.
- 4 To enter the text, select an alphabet/number and then press **OK**.
 - Select an input method, see "Know these keypad icons".
 - To switch between uppercase and lowercase, select **aA** on the displayed keypad and then press **OK**.
- 5 After you enter the text, select **✓** and then press **OK**.
- 6 Move the joystick up/down/right/left to position the text, and then press **OK**.
- 7 Move the joystick up/down/right/left to select the color or font of the text, and then press **OK**.



- 8 Move to **✓**, and then press **OK**.
- 9 Select **[Done]**, and then press **OK**.

View a message

- 1 In the home screen, select **[Message]** and then press **OK**.
- 2 Select **[View Message]**, and then press **OK**.



- 3 Select a message template, and then press **OK**.
 - ↳ A message template is displayed.
- 4 Press **MENU**, and then select an option to continue.

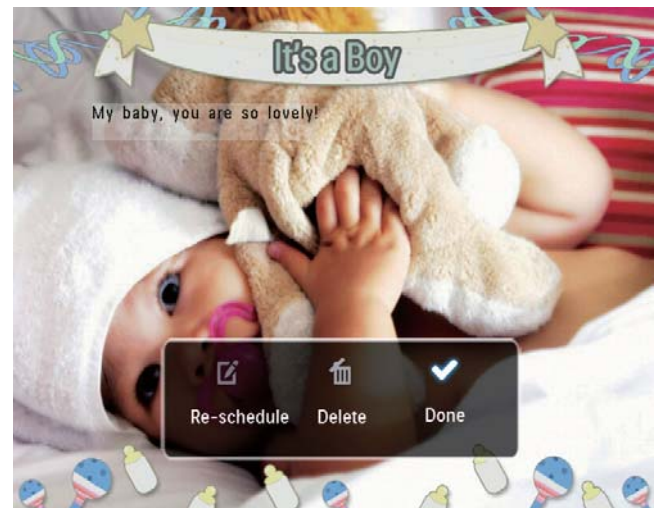

- 5 Follow the on screen instruction to reschedule the message or delete the message.
 - To go back to the message browser screen, select **[Done]** and then press **OK**.

8 Settings

Select an on-screen language

- 1 In the home screen, select **[Settings]** and then press **OK**.



- 2 Select **[Language]**, and then press **OK**.
- 3 Select a language, and then press **OK**.

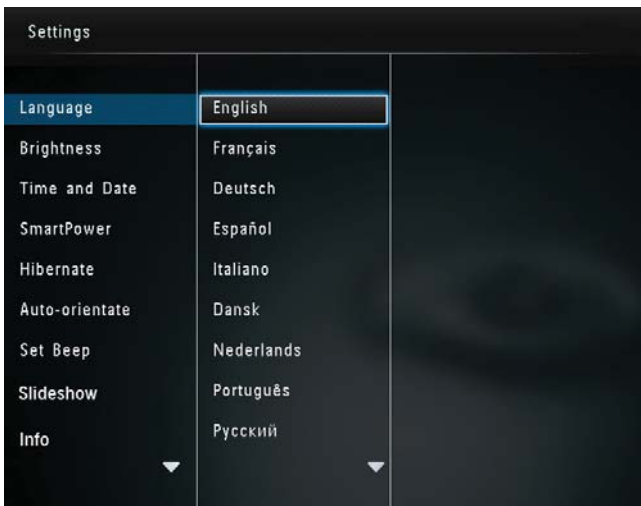

Adjust brightness

You can adjust the brightness of the PhotoFrame to achieve the best view.

- 1 In the home screen, select **[Settings]** and then press **OK**.



- 2 Select **[Brightness]**, and then press **OK**.



- 3 Move the joystick up/down to adjust brightness, and then press **OK**.

Set time/date

- 1 In the home screen, select **[Settings]** and then press **OK**.



- 2 Select **[Time and Date]**, and then press **OK**.

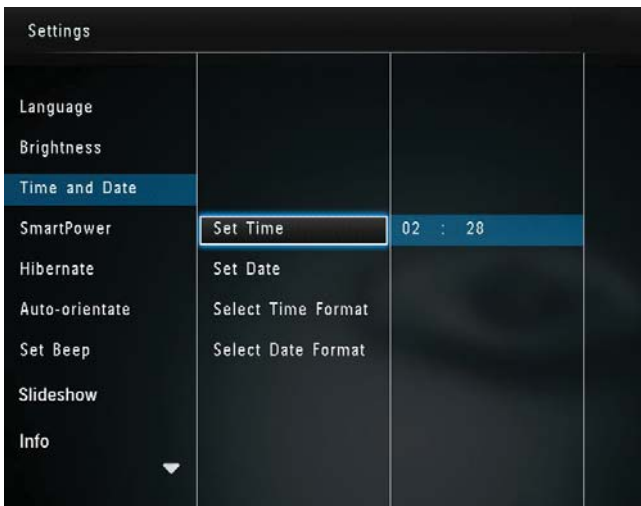

- 3 Select **[Set Time]** / **[Set Date]**, and then press **OK**.

- 4 Move the joystick up/down/right/left to adjust minute/hour/day/month/year, and then press **OK**.



Set time/date format

- 1 In the home screen, select **[Settings]** and then press **OK**.



- 2 Select **[Time and Date]**, and then press **OK**.
- 3 Select **[Select Time Format]** / **[Select Date Format]**, and then press **OK**.

4 Select a format, and then press **OK**.

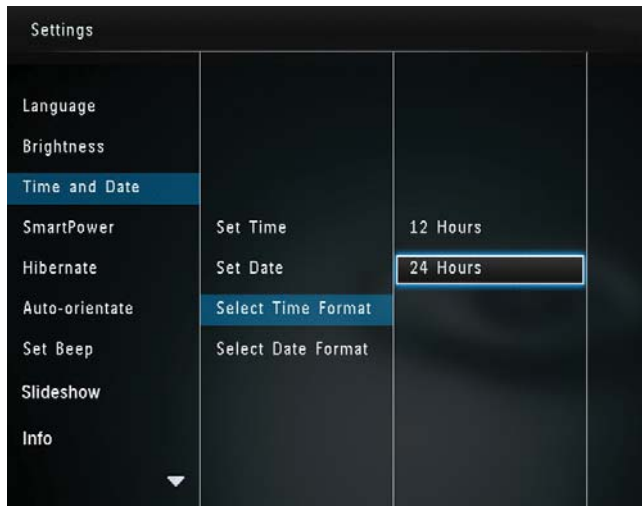

Set SmartPower timer

With the SmartPower timer, you can configure the time for the display of the PhotoFrame to turn on or turn off automatically. When the display automatically turns off, the PhotoFrame goes to standby (sleep) mode.

Note

- Ensure that the current time of the PhotoFrame is set correctly.

1 In the home screen, select [**Settings**] and then press **OK**.



2 Select [**SmartPower**], and then press **OK**.

3 Select [**Set On-Time**] / [**Set Off-Time**], and then press **OK**.

- To switch off the SmartPower function, select [**Off**] and then press **OK**.



4 Move the joystick up/down/right/left to set time, and then press **OK**.



Tip

- When the PhotoFrame is in standby (sleep) mode, you can press **⏻** to wake up the PhotoFrame.

Hibernate the PhotoFrame

- 1 In the home screen, select **[Settings]** and then press **OK**.



- 2 Select **[Hibernate]**, and then press **OK**.
- 3 Select an option, and then press **OK**.

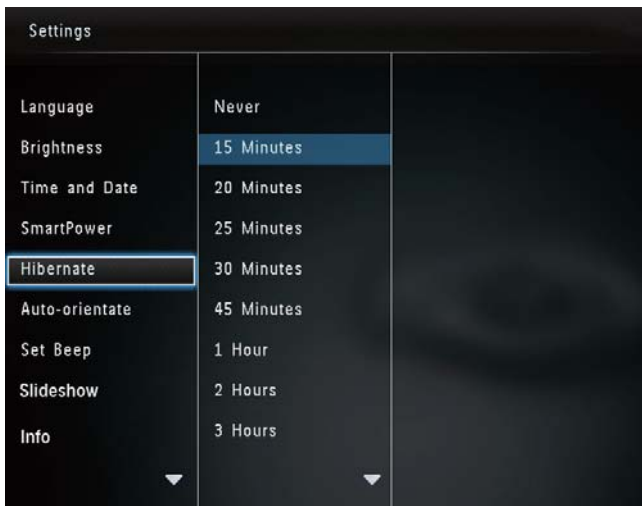

- ↳ After the selected period, the PhotoFrame hibernates.
- To disable the hibernation function, select **[Never]** and then press **OK**.

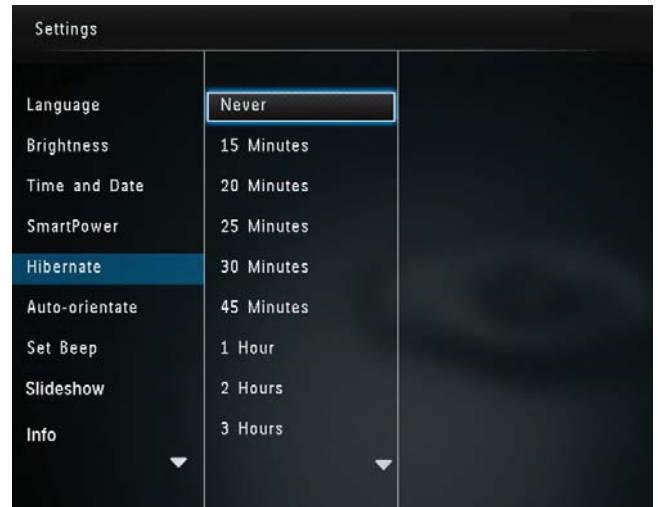

- To get the PhotoFrame out of hibernation, press **⏻**.

Set auto orientation

With the auto orientation function, you can play photos in the correct orientation depending on the horizontal/vertical orientation of the PhotoFrame.

- 1 In the home screen, select **[Settings]** and then press **OK**.



2 Select **[Auto-orientate]**, and then press **OK**.

3 Select **[On]**, and then press **OK**.

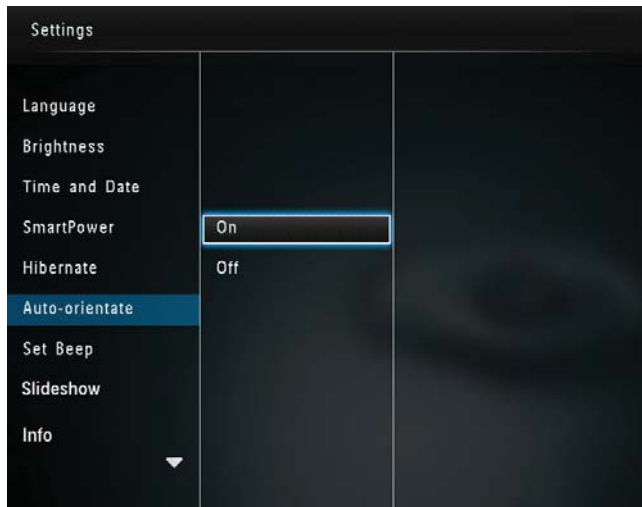

- To disable the auto orientation function, select **[Off]** and then press **OK**.

Turn button sound on/off

1 In the home screen, select **[Settings]** and then press **OK**.



2 Select **[Set Beep]**, and then press **OK**.

3 To turn on the button sound, select **[On]** and then press **OK**.

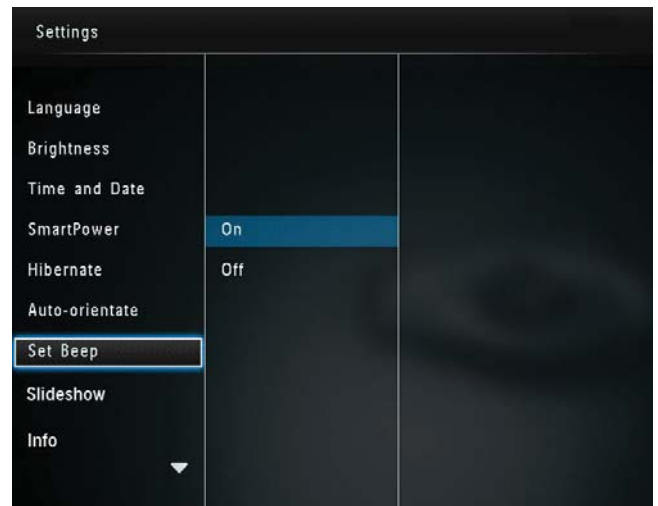

- To turn off the button sound, select **[Off]** and then press **OK**.

Slideshow setting

Select slideshow interval

1 In the home screen, select **[Settings]** and then press **OK**.



2 Select **[Slideshow]**, and then press **OK**.

- 3 Select **[Interval]**, and then press **OK**.

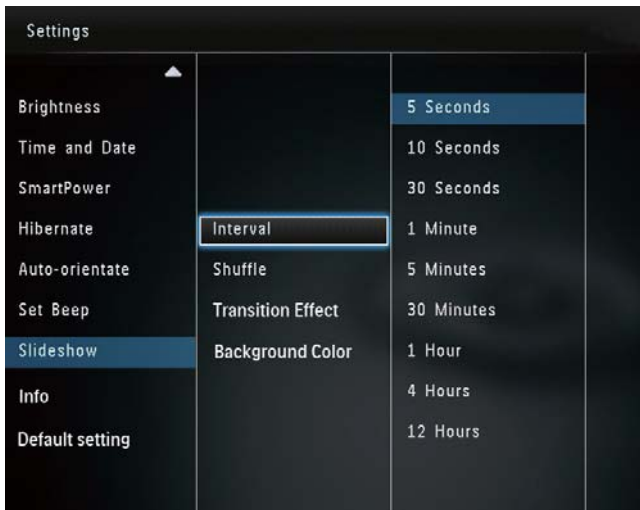

- 4 Select a slideshow interval, and then press **OK**.

Select slideshow sequence

- 1 In the home screen, select **[Settings]** and then press **OK**.



- 2 Select **[Slideshow]**, and then press **OK**.
- 3 Select **[Shuffle]**, and then press **OK**.
- 4 To display slideshow randomly, select **[On]** and then press **OK**.
 - To display slideshow in sequence, select **[Off]** and then press **OK**.

Select transition effect

- 1 In the home screen, select **[Settings]** and then press **OK**.



- 2 Select **[Slideshow]**, and then press **OK**.
- 3 Select **[Transition Effect]**, and then press **OK**.

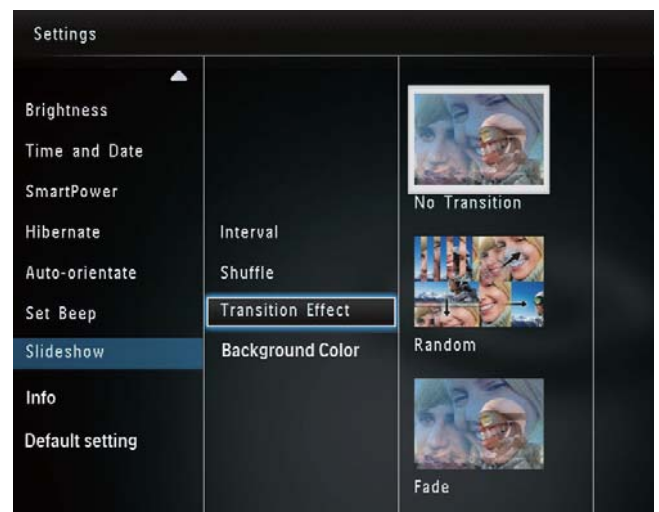

- 4 Select a transition effect, and then press **OK**.

Select background color

You can select a background border color for photos that are smaller than the PhotoFrame display.

- 1 In the home screen, select **[Settings]** and then press **OK**.



- 2 Select **[Slideshow]**, and then press **OK**.
- 3 Select **[Background Color]**, and then press **OK**.
- 4 Select **[RadiantColor]** / a background color/ **[Auto-fit]**, and then press **OK**.

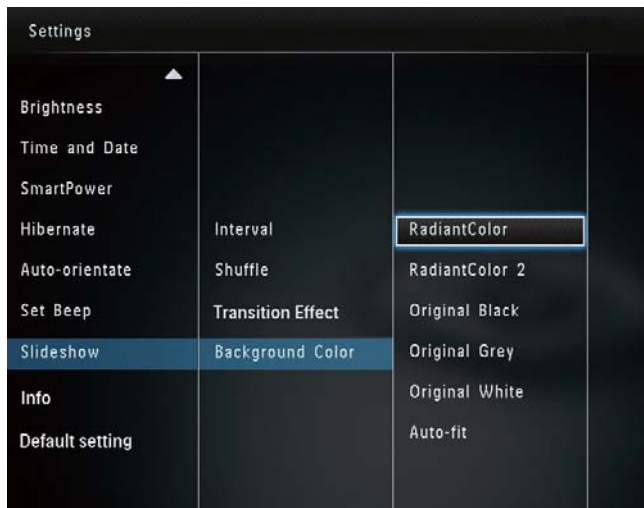

- ↳ If you select **[RadiantColor]**, the PhotoFrame extends the color on the edges of a photo that is smaller than the full screen to fill the screen without black bars or aspect ratio distortion.



- ↳ If you select a background color, the PhotoFrame displays a photo with a background color.



- ↳ If you select **[Auto-fit]**, the PhotoFrame extends a photo to fill the screen with picture distortion.



- 2 Select **[Info]**.
 - ↳ The information of the PhotoFrame is displayed on the screen.



View information of the PhotoFrame

You can find the model name, the firmware version of the PhotoFrame, and the memory status of the PhotoFrame and other storage device available on the PhotoFrame.

- 1 In the home screen, select **[Settings]** and then press **OK**.



Reset all settings to factory default

- 1 In the home screen, select **[Settings]** and then press **OK**.



- 2 Select **[Default Settings]**, and then press **OK**.
 - ↳ A confirmation message is displayed.
 - 3 Select **[Yes]**, and then press **OK**.
 - ↳ All settings on the PhotoFrame are set to factory default.
- To cancel the operation, select **[No]** in the prompt message and then press **OK**.

9 Upgrade the PhotoFrame

Caution

- Do not power off the PhotoFrame during software upgrade.

If there is a software update, you can download the latest software from www.philips.com/support to upgrade your PhotoFrame. The earlier software is unavailable on line.

- 1 Visit www.philips.com/support.
- 2 Search for your PhotoFrame and go to the software section.
- 3 Download the latest software onto the root directory of an SD card.
- 4 Insert the SD card into the PhotoFrame.
- 5 Turn on the PhotoFrame
 - ↳ A confirmation message is displayed.
- 6 Select **[Yes]**, and then press **OK** to confirm.
 - ↳ When the upgrade is complete, the PhotoFrame reboots.

10 Product information

Note

- Product information is subject to change without prior notice.

Picture/Display

- Viewing angle: @ C/R > 10, 130° (H)/110° (V)
- Lifetime, to 50% brightness: 20000 hr
- Aspect ratio: 4:3
- Panel resolution: 800 × 600
- Brightness (typical): 180 cd/m²
- Contrast ratio (typical): 300:1
- Photo format support: JPEG photo (maximum: 8000 × 6000 pixel resolution)

Storage media

- Internal memory capacity: 128 MB
- Memory Card Types:
 - Secure Digital (SD)
 - Secure Digital High Capacity (SDHC)
 - Multimedia Card (MMC)
 - Memory Stick (MS)
 - Memory Stick Pro (MS Pro)

Connectivity

- USB: USB 2.0 Slave

Dimensions & Weight

- Set dimensions without stand (W × H × D): 194.5 × 159 × 28 mm
- Set dimensions with stand (W × H × D): 194.5 × 159 × 93.5 mm
- Weight (with stand): 0.378 kg

Temperature range

- Operation: 0 °C - 40 °C/32 °F - 104 °F
- Storage: -10 °C - 60 °C/14 °F - 140 °F

Power

- Power mode supported: AC powered
- Efficiency level: V
- Average consumption (system on): 4 W
- Power adaptor:
 - Manufacturer: Philips Consumer Lifestyle International B.V.
 - Model number: DSA-3RNA-05 Fxx (xx=EU, UK, AU, CN)
 - Input: AC 100-240V ~ 50-60Hz 0.3A
 - Output : DC 5V = 650mA

Adaptor	Region
DSA-3RNA-05 FEU	Europe, Russia, and Singapore
DSA-3RNA-05 FUK	U.K. and Hong Kong
DSA-3RNA-05 FAU	Australia and New Zealand
DSA-3RNA-05 FCN	China

Accessories

- AC-DC adaptor
- CD-ROM with digital user manual
- Quick start guide

Convenience

- Card Reader: Built-in
- Photo format supported:
 - JPEG photo (maximum: 8000 × 8000 pixel resolution)
 - Progressive JPEG photo (Up to 1024 × 768 pixels)
- Placement supported: Photo auto orientation
- Buttons and controls: Joystick, home/back button, menu button, power/mode button
- Playback mode: Slideshow, thumbnail view, wave view, album view
- Album management: Create, copy, move, delete, add to the favorites album
- Photo management: Copy, move, delete, rotate, add to the favorites album, color tone

- Clock: Clock, calendar, set time and date
- Message: Create message, view message
- Slideshow setting: Transition effect, background color, view mode, interval, shuffle, color tone
- Color tone: Black and white, Sepia, other colors
- Screen background: Black, white, gray, auto fit, RadiantColor
- Settings: Language, brightness, time and date, SmartPower, hibernate, auto orientation, beep (button sound), slideshow settings, information of the PhotoFrame, reset the PhotoFrame to the factory default
- System status: Friendly name, software version, memory size
- Plug & Play Compatibility: Windows Vista/XP/7, Mac OS X 10.4/10.5/10.6
- Regulatory Approvals: BSMI, C-Tick, CCC, CE, GOST, PSB
- Other convenience: Kensington lock compatible
- On-Screen Display languages: English, French, German, Spanish, Italian, Danish, Dutch, Portuguese, Russian, Simplified Chinese, Traditional Chinese

11 Frequently asked questions

Is the LCD screen touch-enabled?

The LCD screen is not touch-enabled. Use the buttons on the back to control the PhotoFrame.

Can I use the PhotoFrame to delete photos on a memory card?

Yes, it supports operations to delete photos on an external device, such as a memory card. Ensure that you enable the deletion function on a memory card available on the PhotoFrame.

Why does my PhotoFrame not show some of my photos?

- The PhotoFrame plays only JPEG photos (maximum: 8000 × 8000 pixel resolution) and Progressive JPEG photo (Up to 1024 × 768 pixels).
- Ensure that these photos are not damaged.

Why does the PhotoFrame not go into auto-off status after I set it?

Ensure that you set the real time, auto-off time, and auto-on time correctly. The PhotoFrame automatically turns off its display exactly at the auto-off time. If the time has already passed for the day, it starts to go into auto-off status at the specified time from the next day.

Can I increase the memory size to store more pictures on the PhotoFrame?

No. The internal memory of the PhotoFrame is fixed and cannot be expanded. However, you could switch between different photos by using different storage devices on the PhotoFrame.

12 Glossary

A

Aspect ratio

Aspect ratio refers to the length to height ratio of TV screens. The ratio of a standard TV is 4:3, while the ratio of a high-definition or wide TV is 16:9. The letter box allows you to enjoy a picture with a wider perspective on a standard 4:3 screen.

J

JPEG

A very common digital still picture format. A still-picture data compression system proposed by the Joint Photographic Expert Group, which features small decrease in image quality in spite of its high compression ratio. Files are recognized by their file extension '.jpg' or '.jpeg.'

K

Kbps

Kilobits per second. A digital-data-rate measurement system which is often used with highly compressed formats such as AAC, DAB, MP3 etc. The higher the amount, the better the quality generally is.

Kensington lock

A Kensington Security Slot (also called a K-Slot or Kensington lock). Part of an anti-theft system. It is a small, metal-reinforced hole found on almost all small or portable computer and electronics equipment, particularly on expensive and/or relatively light ones, such as laptops, computer monitors, desktop computers, gaming consoles, and video projectors. It is used for attaching a lock-and-cable apparatus, in particular those from Kensington.

M

Memory Stick

Memory Stick. A flash memory card for digital storage on cameras, camcorders and other handheld devices.

MMC Card

MultiMedia Card. A flash memory card that provides storage for cellphones, PDAs and other handheld devices. The card uses flash memory for read/write applications or ROM chips (ROM-MMC) for static information, the latter widely used for adding applications to a Palm PDA.

S

SD Card

Secure Digital Memory Card. A flash memory card that provides storage for digital cameras, cellphones and PDAs. SD Cards use the same 32 x 24mm form factor as the MultiMediaCard (MMC), but are slightly thicker (2.1mm vs. 1.4mm), and SD Card readers accept both formats. Cards up to 4GB are available.

T

Thumbnail

A thumbnail is reduced-size versions of a picture that is used to make it easier to recognize an them. Thumbnails serve the same role for images as a normal text index does for words.

