

Register your product and get support at
www.philips.com/welcome

Immersive

3000 series



Quick start guide

PHILIPS

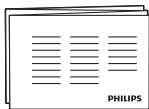

- EN** Before using your product, read all accompanying safety information
- DA** Læs alle medfølgende sikkerhedsoplysninger, inden du tager produktet i brug
- DE** Lesen Sie vor Verwendung dieses Produkts alle begleitenden Sicherheitsinformationen
- EL** Πριν χρησιμοποιήσετε το προϊόν, διαβάστε όλες τις παρεχόμενες πληροφορίες ασφάλειας
- ES** Antes de usar el producto, lea toda la información de seguridad adjunta
- FI** Lue kaikki turvallisuuksiedot ennen tuotteen käyttöä
- FR** Avant d'utiliser votre produit, lisez l'intégralité des consignes de sécurité jointes
- IT** Prima di utilizzare il prodotto, leggere tutte le relative informazioni sulla sicurezza
- NL** Lees voordat u het product gaat gebruiken eerst alle bijbehorende veiligheidsinformatie
- NO** Les all vedlagt sikkerhetsinformasjon før du bruker produktet
- PT** Antes de utilizar o produto, leia todas as informações de segurança que o acompanham
- SV** Innan du använder produkten ska du läsa all tillhörande säkerhetsinformation
- TR** Ürününüzü kullanmadan önce ilgili tüm güvenlilik bilgilerinizi okuyun
- CS** Před použitím produktu si přečtěte doprovodné bezpečnostní informace
- HU** A termék használatá elótt alaposan olvassa el a mellékelt biztonsági tudnivalókat
- PL** Przed rozpoczęciem korzystania z produktu należy zapoznać się z informacjami dotyczącymi bezpieczeństwa
- RO** Înainte de a utiliza acest produs, citiți toate informațiile de siguranță care îl însoțesc
- SK** Pred použitím produktu si prečítajte všetky sprievodné bezpečnostné informácie



- EN** What's in the box
- DA** Hvad følger med
- DE** Verpackungsinhalt
- EL** Περιεχόμενα συσκευασίας
- ES** Contenido de la caja
- FI** Pakkauksen sisältö
- FR** Contenu de l'emballage
- IT** Contenuto della confezione
- NL** De inhoud van de doos
- NO** Innholdet i esken
- PT** Conteúdo da embalagem
- SV** Vad finns i förpackningen?
- TR** Kutu içeriği
- CS** Obsah balení
- HU** A doboz tartalma
- PL** Zawartość opakowania
- RO** Ce se află în cutie
- SK** Obsah balenia

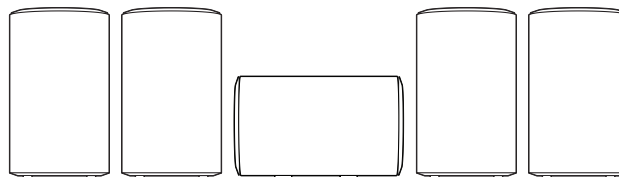
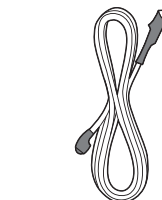
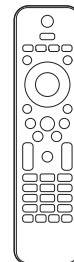
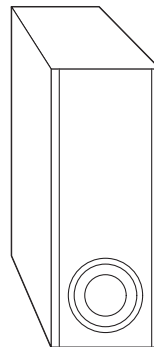
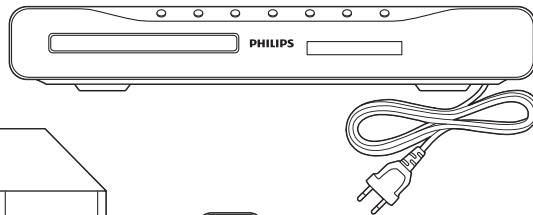
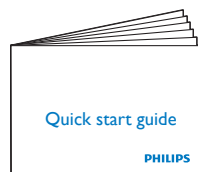
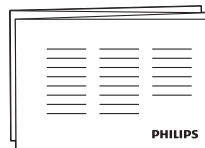
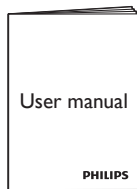

1

- EN** Position the speakers
- DA** Vælg en placering til højttalerne
- DE** Positionieren der Lautsprecher
- EL** Τοποθετήστε τα ηχεία
- ES** Coloca los altavoces
- FI** Kaiuttimien sijainti
- FR** Positionner les enceintes
- IT** Posizionamento degli altoparlanti
- NL** Plaats de luidsprekers
- NO** Plassere høyttalerne
- PT** Posicionar os altifalantes
- SV** Placera högtalarna
- TR** Hoparlörleri yerleştirin
- CS** Umístěte reproduktory
- HU** A hangszórzók elhelyezése
- PL** Rozmieszczenie głośników
- RO** Poziționati boxeale
- SK** Rozmiestnenie reproduktorov

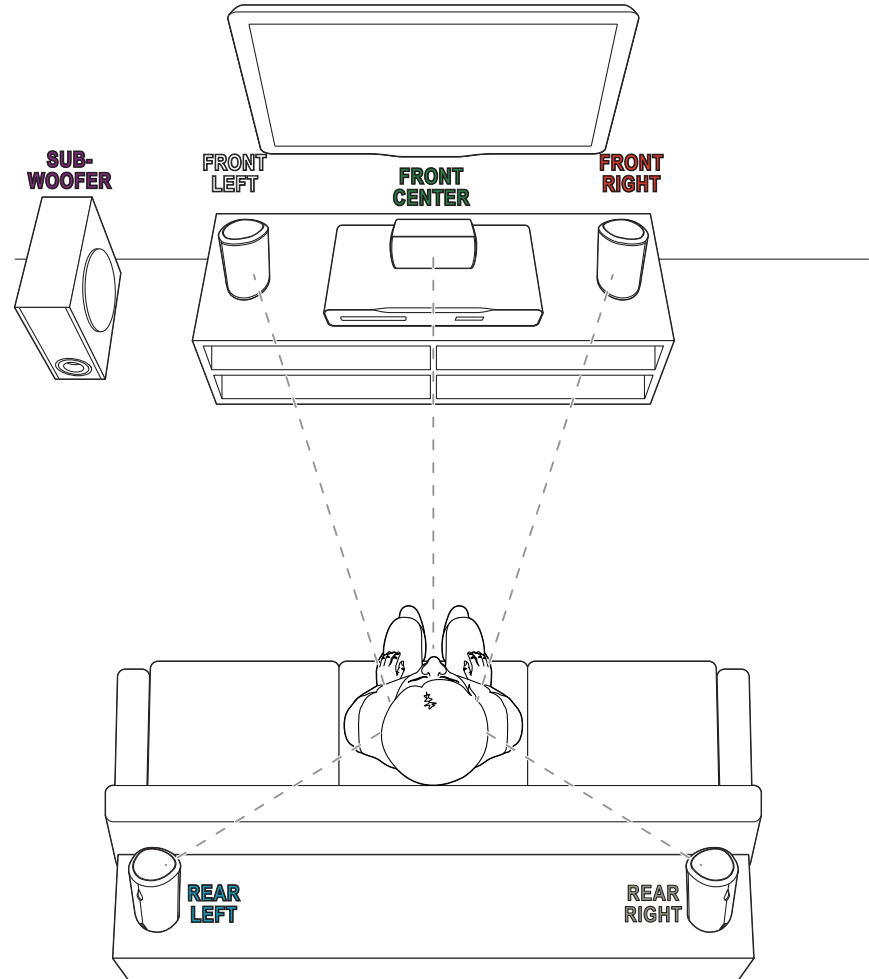

2

- EN** Connect the home theater
- DA** Tilslut hjemmebiografen
- DE** Anschließen des Home Entertainment-Systems
- EL** Συνδέστε το home cinema
- ES** Conecta el sistema de cine en casa
- FI** Kotiteatterin liitännät
- FR** Connecter les enceintes au Home Cinéma
- IT** Collegamento del sistema Home Theater
- NL** Sluit de home cinema aan
- NO** Koble til hjemmekinoanlegget
- PT** Efectuar as ligações ao sistema de cinema em casa
- SV** Anslut hemmabiosystemet
- TR** Ev sinemasını bağlayın
- CS** Připojte domácí kino
- HU** A házimozsi csatlakoztatása
- PL** Podłączenie zestawu kina domowego
- RO** Conectați sistemul home theater
- SK** Pripojenie k domácu kinu

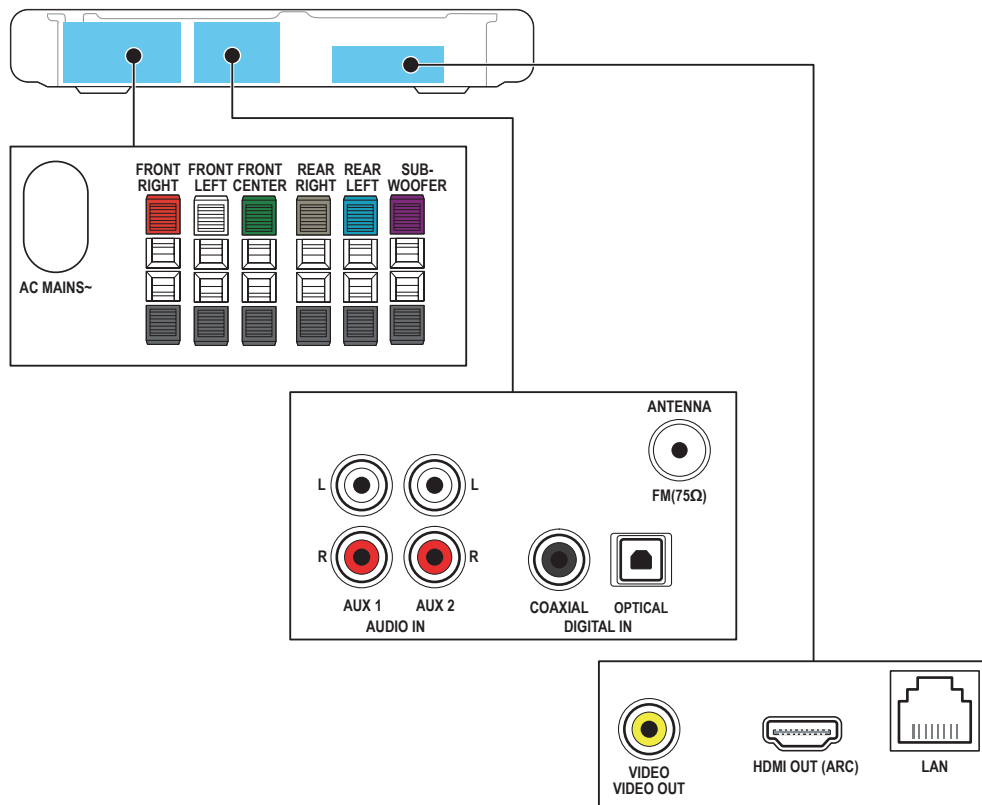

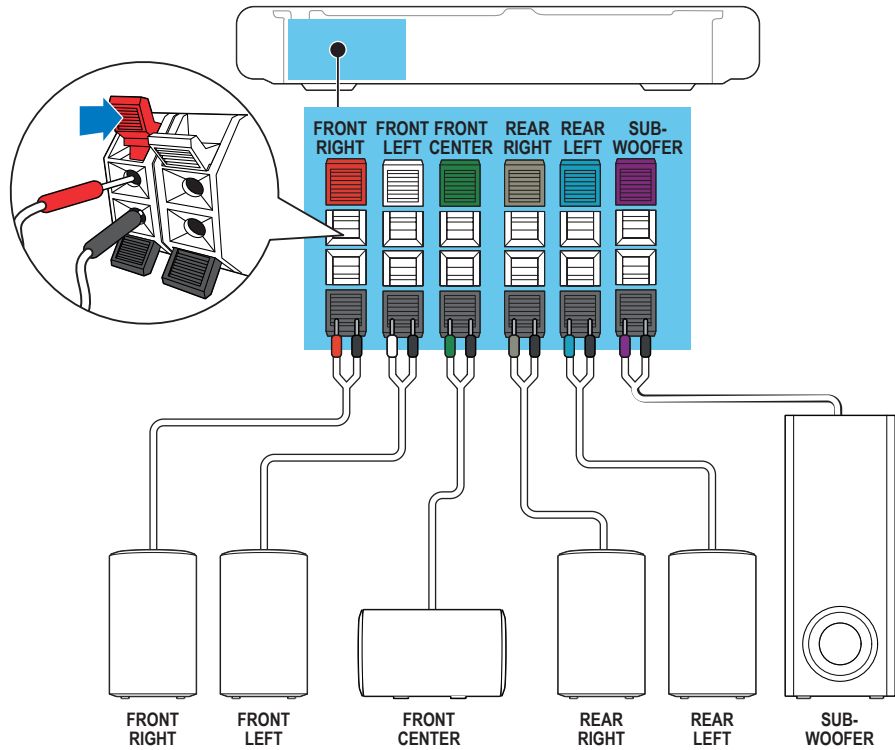

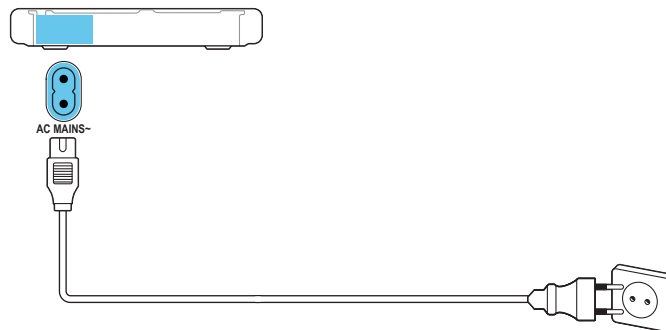
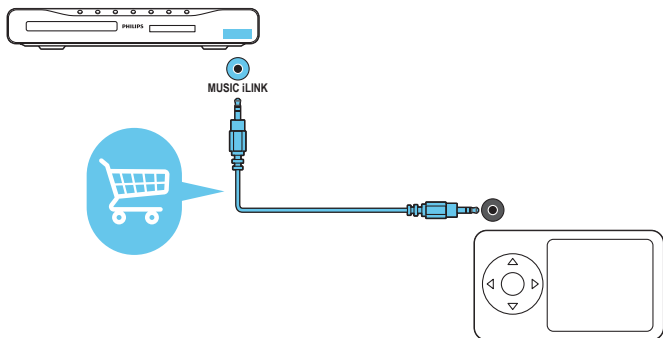
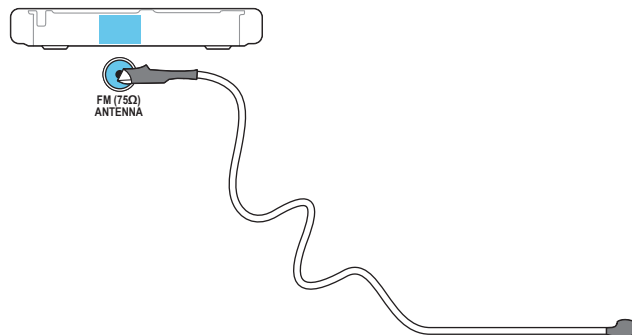
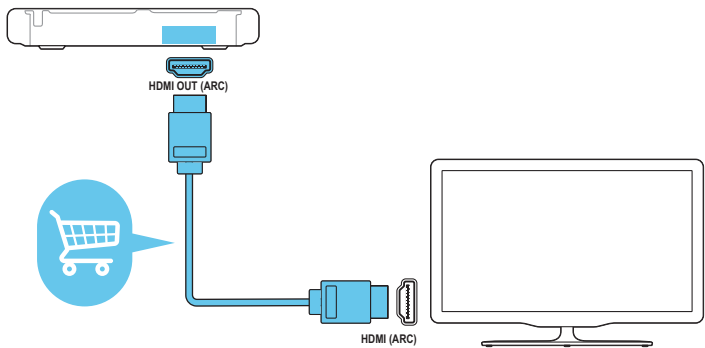

3

- EN** Switch on the home theater
- DA** Tænd for hjemmebiografen
- DE** Einschalten des Home Entertainment-Systems
- EL** Ενεργοποιήστε το home cinema
- ES** Enciende el sistema de cine en casa
- FI** Virran kytkeminen kotiteatteriin
- FR** Mettre sous tension le Home Cinéma
- IT** Accensione del sistema Home Theater
- NL** Schakel de home cinema in
- NO** Slå på hjemmekinoanlegget
- PT** Ligar o sistema de cinema em casa
- SV** Sätt på hemmabiosystemet
- TR** Ev sinemasını açın
- CS** Zapněte domácí kino
- HU** A házimozi bekapcsolása
- PL** Włączenie zestawu kina domowego
- RO** Porniți sistemul home theater
- SK** Zapnutie domáceho kina

1

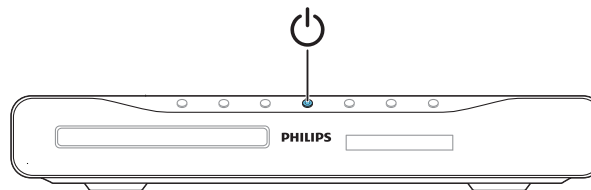

2

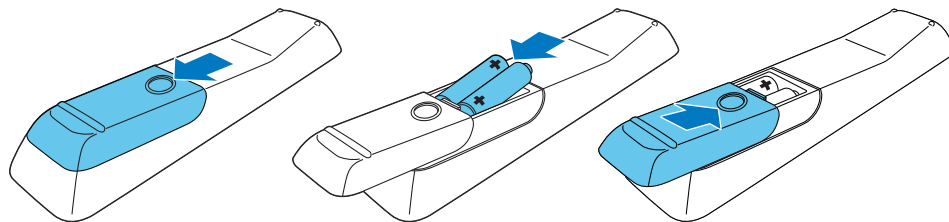

4



- EN** Complete the first time setup
- DA** Fuldfør den indledende opsætning
- DE** Abschließen der Ersteinrichtung
- EL** Ολοκληρώστε τη ρύθμιση για πρώτη φορά
- ES** Finaliza la configuración inicial
- FI** Ensiasennuksen suorittaminen loppuun
- FR** Effectuer la configuration initiale
- IT** Completamento della configurazione iniziale
- NL** Voltooi de eerste installatie
- NO** Fullføre den første konfigureringen
- PT** Executar a configuração inicial
- SV** Slutför förstagångsinställningen
- TR** İlk kullanim öncesi kurulumunu tamamlayın
- CS** Dokončíte jste nastavení při prvním zapnutí
- HU** Az első üzembe helyezés
- PL** Pierwsza konfiguracja
- RO** Realizați prima configurare
- SK** Dokončenie prvého nastavenia

1

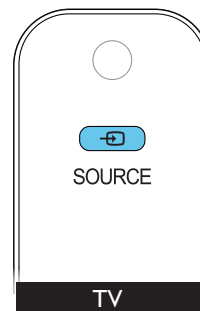
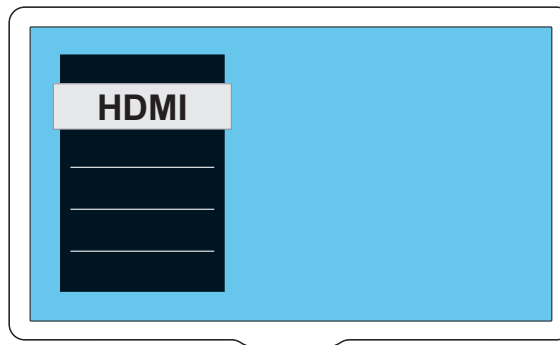

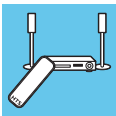

2

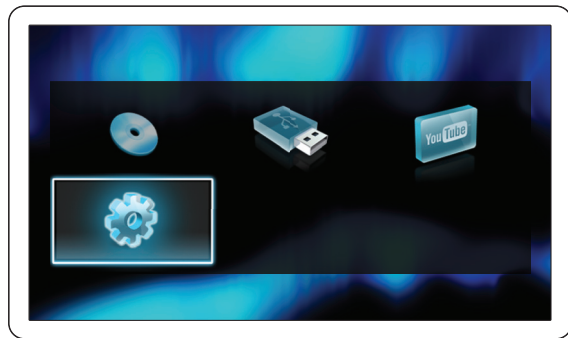

3

Video	Menu Language	Auto (ENG)
Audio	Audio	English
Network	Subtitle	Français
EasyLink	Disc Menu	Deutsch
Preference	Parental Control	Italiano
Advanced	Screen Saver	Español
	Change Password	Português
	Display Panel	Nederland

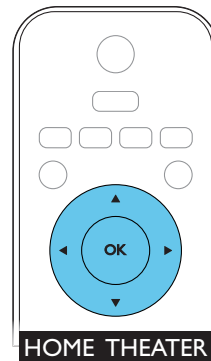
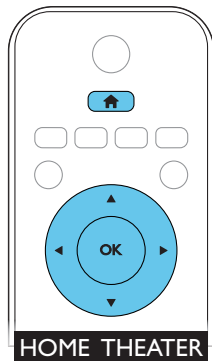

5

- EN** Use your home theater
DA Brug af din hjemmteater
DE Verwenden des Home Entertainment-Systems
EL Χρησιμοποιήστε το home cinema
ES Uso del sistema de cine en casa
FI Kotiteatterin käyttäminen
FR Utiliser votre Home Cinéma
IT Utilizzo del sistema Home Theater
NL Uw home cinema bedienen
NO Bruke hjemmekinoanlegget
PT Utilizar o sistema de cinema em casa
SV Använda hemmabiosystemet
TR Ev sinema sisteminin kullanılması
CS Použití domácího kina
HU A házimozó használat
PL Korzystanie z zestawu kina domowego
RO Utilizați sistemul home theater
SK Používanie domáceho kina

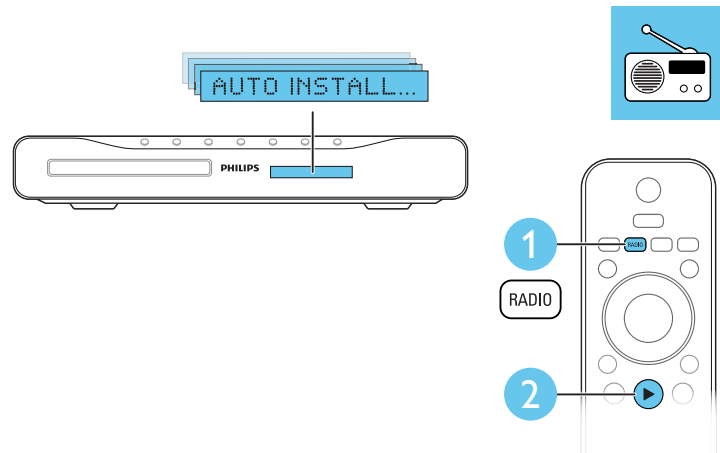
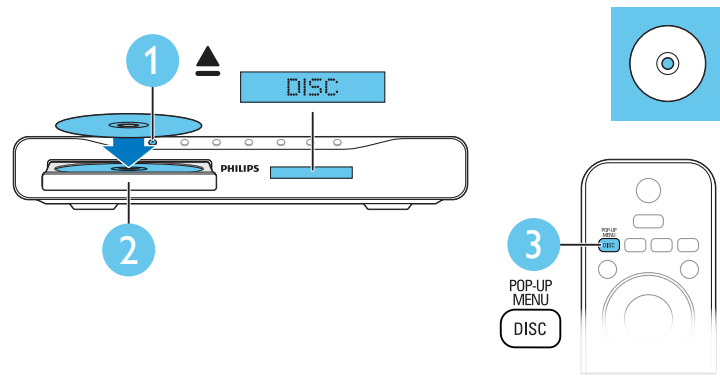

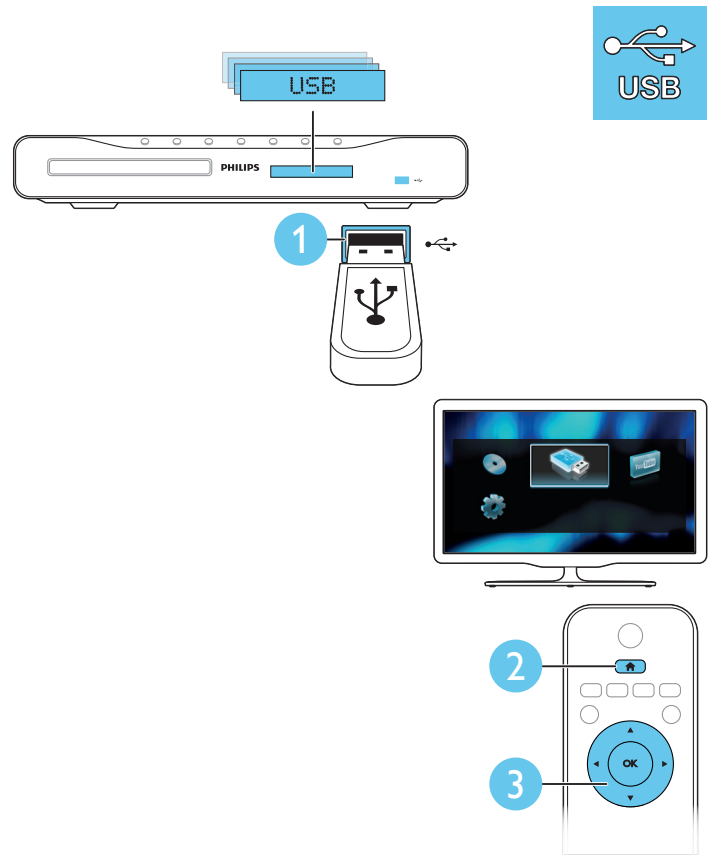
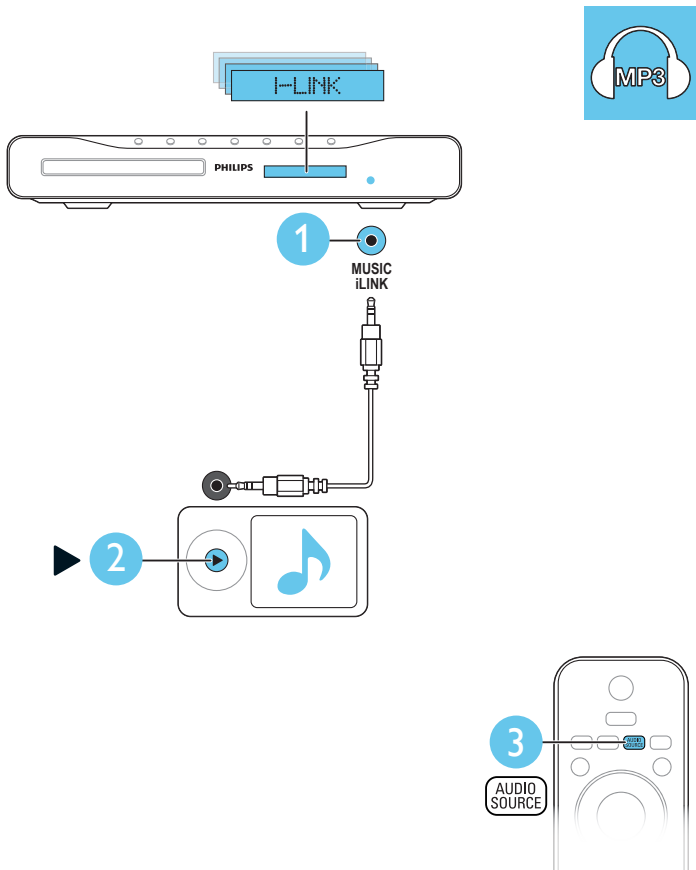



- EN** Download software updates and a printable user manual from www.philips.com/support.
- DA** Download softwareopdateringer og en printervenlig brugervejledning fra www.philips.com/support.
- DE** Laden Sie Software-Updates und eine druckbare Bedienungsanleitung unter www.philips.com/support herunter.
- EL** Λάβετε ενημερώσεις λογισμικού και ένα εγχειρίδιο χρήστη με δυνατότητα εκτύπωσης από τη διεύθυνση www.philips.com/support.
- ES** Descargue de www.philips.com/support las actualizaciones de software y un manual de usuario imprimible.
- FI** Lataa ohjelmistopäivitykset ja tulostettava käyttöopas osoitteesta www.philips.com/support.
- FR** Téléchargez les mises à jour logicielles et un mode d'emploi imprimable à la page www.philips.com/support.
- IT** Scaricare gli aggiornamenti e il manuale dell'utente stampabile dal sito www.philips.com/support.
- NL** Download software-updates en een printversie van de gebruikershandleiding via www.philips.com/support.
- NO** Last ned programvareoppdateringer og en brukerhåndbok for utskrift fra www.philips.com/support.
- PT** Transferir atualizações de software e um manual de utilizador imprimível a partir do site www.philips.com/support.
- SV** Hämta programuppdateringar och en utskrivbar användarhandbok från www.philips.com/support.
- TR** Yazılım güncellemelerini ve yazdırılabilir kullanım kılavuzunu www.philips.com/support adresinden indirin.
- CS** Stáhněte si aktualizace softwaru a uživatelskou příručku k tisku ze stránek www.philips.com/support.
- HU** Töltse le a szoftverek újabb verzióját és a nyomtatható használati útmutatót a www.philips.com/support weboldalról.
- PL** Pobierz aktualizacje oprogramowania i drukowaną wersję instrukcji obsługi ze strony www.philips.com/support.
- RO** Descărcați actualizări software și un manual de utilizare care poate fi tipărit de la www.philips.com/support.
- SK** Aktualizácie softvéru a používateľskú príručku určenú na tlač môžete prevziať z lokality www.philips.com/support.





Non-contractual images. / Images non contractuelles. / Außervertragliche Bilder.

All registered and unregistered trademarks are property of their respective owners.

Specifications are subject to change without notice

Trademarks are the property of Koninklijke Philips Electronics N.V. or their respective owners
2011 © Koninklijke Philips Electronics N.V. All rights reserved

www.philips.com
ythy_1119/12_v3



Be responsible
Respect copyrights

