

PHILIPS

Clock Radio

4000 Series

R4406



User manual

Register your product and get support at:
www.philips.com/support

Contents

1	Important	2
	Safety	2
	FCC information	2
<hr/>		
2	Your clock radio	3
	Introduction	3
	What's in the box	3
	Overview of the clock radio	3
<hr/>		
3	Get started	4
	Install batteries	4
	Connect power	4
	Set time	4
<hr/>		
4	Listen to FM radio	5
	Tune to FM radio stations	5
	Store FM radio stations automatically	5
	Store FM radio stations manually	5
	Select a preset radio station	5
	Adjust volume	5
<hr/>		
5	Other features	6
	Set alarm time	6
	Set sleep timer	6
	Adjust display brightness	6
	Charging device via USB port	6
<hr/>		
6	Product information	7
<hr/>		
7	Troubleshooting	7

1 Important

Safety

- Read these instructions.
- Heed all warnings.
- Follow all instructions.
- Do not block any ventilation openings. Install in accordance with the manufacturer's instructions.
- Do not install near any heat sources such as radiators, heat registers, stoves, or other apparatus (including amplifiers) that produce heat.
- Protect the power cord from being walked on or pinched, particularly at plugs, convenience receptacles, and the point where they exit from the clock radio.
- Only use attachments/accessories specified by the manufacturer.
- Unplug this apparatus during lightning storms or when unused for long periods of time.
- Refer all servicing to qualified service personnel. Servicing is required when the apparatus has been damaged in any way, such as power-supply cord or plug is damaged, liquid has been spilled or objects have fallen into the apparatus, the apparatus has been exposed to rain or moisture, does not operate normally, or has been dropped.
- Battery usage CAUTION - To prevent battery leakage which may result in bodily injury, property damage, or damage to the clock radio:
 - Install all batteries correctly, + and - as marked on the unit.
 - Remove batteries when the unit is not used for a long time.
 - The battery shall not be exposed to excessive heat such as sunshine, fire or the like.
- This clock radio shall not be exposed to dripping or splashing.
- Do not place any sources of danger on the clock radio (e.g. liquid filled objects, lighted candles).
- Where the plug of the Direct Plug-in Adapter is used as the disconnect device, the disconnect device shall remain readily operable.

FCC information

NOTE: This equipment has been tested and found to comply with the limits for a Class B digital device, pursuant to Part 15 of the FCC Rules. These limits are designed to provide reasonable protection against harmful interference in a residential installation. This equipment generates, uses and can radiate radio frequency energy and, if not installed and used in accordance with the instructions, may cause harmful interference to radio communications. However, there is no guarantee that interference will not occur in a particular installation. If this equipment does cause harmful interference to radio or television reception, which can be determined by turning the equipment off and on, the user is encouraged to try to correct the interference by one or more of the following measures:

- Reorient or relocate the receiving antenna.
- Increase the separation between the equipment and receiver.
- Connect the equipment into an outlet on a circuit different from that to which the receiver is connected.
- Consult the dealer or an experienced radio / TV technician for help.

This device complies with part 15 of the FCC Rules, Operation is subject to the following two conditions: (1) this device may not cause harmful interference, and (2) this device must accept any interference received, including interference that may cause undesired operation

IC-Canada : CAN ICES-3(B)/NMB-3(B)

This device contains licence-exempt transmitter(s)/receiver(s) that comply with Innovation, Science and Economic Development Canada's licence-exempt RSS(s). Operation is subject to the following two conditions:

1. This device may not cause interference.
2. This device must accept any interference, including interference that may cause undesired operation of the device.

2 Your clock radio

Congratulations on your purchase, and welcome to Philips! To fully benefit from the support that Philips offers, register your product at www.philips.com/support.

Introduction

With this clock radio, you can

- listen to FM radio;
- set two alarms to ring at different times;
- charge your mobile devices.

What's in the box

Check and identify the contents of your package:

- Main unit
- Power adaptor
- Quick start guide
- Warranty

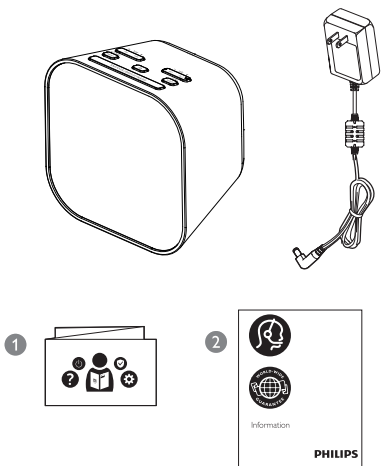

Overview of the clock radio

- ① 
 - Turn on or switch to standby.
- ② **PRESET / SET TIME**
 - Store radio stations in memory.
 - Select a preset radio station.
 - Set time.
- ③ **HR / MIN / ◀ TUN ▶**
 - Set hour and minute.
 - Tune to FM radio stations.
- ④ **SNOOZE / BRIGHTNESS**
 - Snooze alarm.
 - Adjust display brightness.
- ⑤ **Display panel**
 - Display current status.
- ⑥ **SLEEP / SCAN**
 - Set the sleep timer.
 - Scan and store radio stations automatically.
- ⑦ **AL1 / AL2 / – VOL +**
 - Set alarm.
 - Adjust volume.
- ⑧ **USB charging port**
 - Charge your mobile devices.

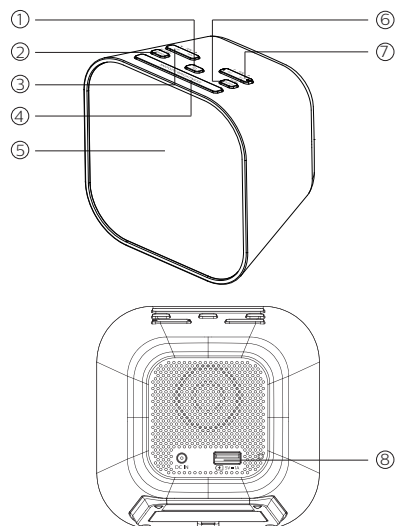

3 Get started

Always follow the instructions in this chapter in sequence.

Install batteries

The batteries can only back up clock and alarm settings.



Caution

- Risk of explosion! Keep the batteries away from heat, sunshine or fire. Never discard batteries in fire.
- Batteries contain chemical substances, so they should be disposed of properly.
- Do not mix battery types: e.g. alkaline with carbon zinc. Only use batteries of the same type for the set.

Insert 2 AAA batteries (not provided) with correct polarity (+/-) as illustrated.

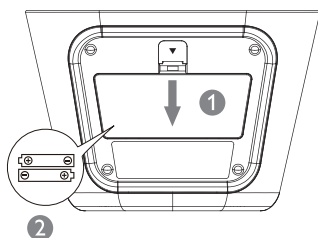

Note

- The type plate is located at the bottom of the clock radio.

Connect the power adaptor to the wall outlet.

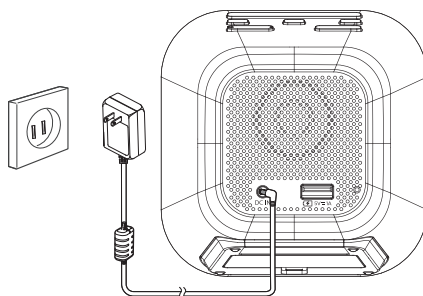

Set time



Note

- You can only set time in standby mode.

- 1 In standby mode, press and hold **SET TIME** for 2 seconds.
- 2 Press **◀ TUN ▶** to select **< 24Hr >** or **< 12Hr >** hour format, then press **SET TIME** to confirm.
- 3 Press **HR** to set hour and **MIN** to set minute, then press **SET TIME** to confirm.
↳ The time is set.

Connect power



Caution

- Risk of product damage! Make sure that the power voltage corresponds to the voltage printed on the back or underside of the clock radio.
- Risk of electrical shock! When you unplug the power cord, always pull the plug from the socket. Never pull the cord.

4 Listen to FM radio



Note

- Keep the clock radio away from other electronic devices to avoid radio interference.
- For better reception, fully extend and adjust the position of the FM antenna.

Tune to FM radio stations

- 1 Press to turn on the clock radio.
- 2 Press and hold **◀ TUN ▶** for 2 seconds. The clock radio tunes to a station with strong reception automatically.
- 3 Repeat Step 2 to tune to more radio stations.

To tune to a station manually:

Press **◀ TUN ▶** repeatedly to select a frequency.



Note

- The tuning grid of the clock radio is 50KHz, the radio frequency on the display panel will increase 0.1MHz by pressing **◀ TUN ▶** twice.

Store FM radio stations automatically

In FM tuner mode, press and hold **SCAN** for more than 2 seconds.

- ↳ The unit stores all the available FM radio stations automatically and broadcasts the first station.



Note

- You can store a maximum of 20 FM radio stations.

Store FM radio stations manually

- 1 In FM tuner mode, tune to an FM radio station.
- 2 Press and hold **PRESET** for 2 seconds to activate programming mode.
↳ The preset number begins to blink.
- 3 Press **◀ TUN ▶** repeatedly to select a number.
- 4 Press **PRESET** again to confirm.
- 5 Repeat steps 1 to 4 to store more FM radio stations.



Tip

- To remove a pre-stored station, store another station in its place.

Select a preset radio station

Option A:

In FM tuner mode, press **PRESET** repeatedly to select a preset number.

Option B:

- 1 In FM tuner mode, press **PRESET**.
- 2 Press **◀ TUN ▶** to select a preset radio station.

Adjust volume

While listening, press **– VOL +** to adjust volume.

5 Other features

Set alarm time

Set alarm

Note

- You can only set the alarm in standby mode.
- Make sure that you have set the clock correctly.

- 1 In standby mode, press and hold **AL1** or **AL2** for 2 seconds to set alarm time.
- 2 Press **HR** to set hour and **MIN** to set minute, then press **AL1** or **AL2** to confirm.
- 3 Press **◀ TUN ▶** to select alarm source: buzzer or your last listened FM station, then press **AL1** or **AL2** again to confirm.

Tip

- The unit exits alarm setting mode when being idle for 10 seconds.

Activate/deactivate alarm timer

Press **AL1** or **AL2** repeatedly to activate or deactivate the alarm timer.

- ↳ If the alarm timer is activated, the alarm indicator turns on.
- ↳ If the alarm timer is deactivated, the alarm indicator turns off.
- ↳ The alarm repeats ringing for the next day.
- ↳ To stop the alarm, press the corresponding **AL1** or **AL2**

Snooze the alarm

When the alarm sounds, press **SNOOZE**.

- ↳ The alarm snoozes and repeats ringing 9 minutes later.

Set sleep timer

This clock radio can switch to standby mode automatically after a preset period.

- Press **SLEEP** repeatedly to select a period (in minutes).
 - ↳ The clock radio switches to standby mode automatically after the preset period.

To deactivate the sleep timer:

- Press **SLEEP** repeatedly until **[OFF]** (off) appears.

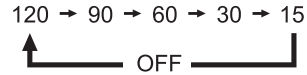

Adjust display brightness

Press **BRIGHTNESS** repeatedly to select different brightness levels:

- High
- Medium
- Low

Charging device via USB port

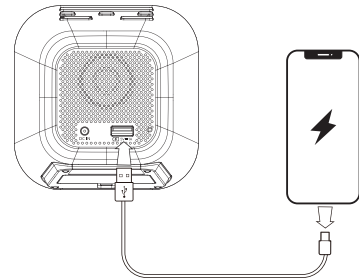

Connect the standard size end of a USB cable (not included) to the USB Port on back of the unit and connect the other end to the charging port on your device.

6 Product information

Note

- Product information is subject to change without prior notice.

Amplifier

Rated Output Power	700mW RMS
--------------------	-----------

Tuner (FM)

Tuning Range	87.5-108 MHz
Tuning Grid	100 KHz
Sensitivity - Mono, 26 dB S/N Ratio	<22 dBf
Total Harmonic Distortion	<3%
Signal to Noise Ratio	>50 dBA

USB charging port

USB charging	5V $\overline{=}$ 1A
--------------	----------------------

General information

AC Power (power adaptor)	Brand: Philips Model: AS150-050-AE150 Input: 100-240V~50/60 Hz; 0.7A Output: 5V $\overline{=}$ 1.5A
Operation Power Consumption	<7.5 W
Standby Power Consumption	<1 W
Dimensions (W x H x D)	110 x 110 x 75 mm
Weight (Main unit)	224.6 g

7 Troubleshooting

Warning

- Never remove the casing of the product.

To keep the warranty valid, never try to repair the device yourself. If you encounter problems when using this device, check the following points before requesting service. If the problem remains unsolved, go to the Philips webpage www.philips.com/support. When you contact Philips, make sure that the device is nearby and the model number and serial number are available.

No power

- Make sure that the AC power plug of the unit is connected properly.
- Make sure that there is power at the AC outlet.

No sound

- Adjust the volume.

No response from the unit

- Disconnect and reconnect the AC power plug, then turn on the unit again.

Poor radio reception

- Keep the clock radio away from other electronic devices to avoid radio interference.
- Fully extend and adjust the position of the antenna.

Alarm does not work

- Set the clock/alarm correctly.

Clock/alarm setting erased

- Power has been interrupted or the power plug has been disconnected.
- Reset the clock/alarm.
- Replace the backup batteries.



2021 © MMD Hong Kong Holding Limited. All rights reserved. Specifications are subject to change without notice.

Philips and the Philips Shield Emblem are registered trademarks of Koninklijke Philips N.V. and are used under license. This product has been manufactured by and is sold under the responsibility of MMD Hong Kong Holding Limited or one of its affiliates, and MMD Hong Kong Holding Limited is the warrantor in relation to this product.