

DVD Mini-HiFi System

FWDI32

Register your product and get support at
www.philips.com/welcome

User manual



PHILIPS

CAUTION

Use of controls or adjustments or performance of procedures other than herein may result in hazardous radiation exposure or other unsafe operation.

General Information/ Maintenance

Features	4
Discs for playback	4
Region codes	4
Supplied accessories	4
Environmental information	4
Care and safety information	5

Connections

Step 1: Placing speakers	6
Step 2: Connecting speakers	6
Step 3: Connecting TV set	7
Using Video In jack (CVBS)	7
Using LINE OUT jack (L/R)	7
Step 4: Connecting the power cord	7

Functional Overview

Controls on the system	8
Remote control	9

Preparations

Step 1: Inserting batteries into the remote control	10
Using the remote control to operate the system	10
Step 2: Setting the TV set	10
Selecting the color system that matches your TV set	10
Step 3: Setting language preference	11

Basic Functions

Switching on/off	12
Switching the system ON	12
Switching the system to STANDBY mode	12
Power saving automatic standby	12
Sound control	12
Selecting sound effect	12
Selecting DBB effect	12
Volume control	12
Changing the volume level	12
Switching off the volume temporarily	12

Disc Operations

Playing discs	13
Using the disc menu	13
Basic playback controls	13
Skipping to another title (track)/chapter	14
To go directly to any title (track)/chapter	14
Fast search	14
Continuing playback from the last stop point	14
Selecting various mode functions	14

Repeat play / Shuffle play mode	14
To cancel Shuffle mode:	14
Repeating a section within a chapter/track	15
Programming favorite Chapters/tracks	15
Special DVD/VCD features	15
Changing subtitle language	15
Changing the pictures scales	15
Changing sound track language	16
Searching for a particular passage	16
Playing in slow motion mode	16
Displaying the disc information during playback	16
Viewing from another angle	16
Moving to another title/chapter	17
Playing from a selected point	17
Playback control (PBC)	17
Checking the contents of DVD	17

MP3/ Picture Disc Operations

Playing MP3/Picture disc (Kodak, JPEG)	18
MP3/JPEG Picture disc	18
Kodak Picture disc	18

DVD Menu Operations

Using the setup menu (user preference settings)	19
Setting the TV Display	19
Setting the screen saver	20
Changing the password	20
Restricting playback by setting parental level	21
OSD Lang	21
Default	21

Tuner Operations

Tuning to radio stations	22
Tape playback	22

Tape Operation/Recording

General information on recording	23
Preparation for recording	23
Disc synchro recording	23

Specifications

Troubleshooting

Glossary

General Information/Maintenance

Congratulations on your purchase and welcome to Philips!

To fully benefit from the support that Philips offers, register your product at www.philips.com/welcome.

Features

Your DVD Mini Hi-Fi System with 2-channel full analog amplifier creates the same dynamic sound qualities that you find in full-fledged cinemas and incorporates some of the best features in home theater technology.

Other features include:

Built-In Dolby Digital decoder, supporting stereo.

Additional Component Connections

Lets you connect other audio and audio/visual components to the system so you can use the system's speakers.

Parental control (rating level)

Lets you set a rating level so that your children cannot watch a DVD that has a rating higher than you set.

Discs for playback

Your DVD Mini Hi-Fi System will play:

- Digital Video Discs (DVDs)
- Video CDs (VCDs)
- Super Video CDs (SVCDs)
- Digital Video Discs + Rewritable (DVD+RW)
- Compact Discs (CDs)
- CD Graphic (CDG)
- Picture (Kodak, JPEG) files on CDR(W)
- MP3/Windows Media™ Audio discs
- ISO 9660 / UDF format
- Max. title/album name –14 characters
- Max. title number plus album is 300
- Max. nested directory is 8 levels
- The max. album number is 32
- The max. MP3 track number is 650
- Supported sampling frequencies for MP3 disc: 32 kHz, 44.1 kHz, 48 kHz
- Supported Bit-rates: 32- 256 (kbps) variable bit rates (average 128 kbps)



- Following formats can't be supported.
- The files like *.VMA, *.AAC, *.DLF, *.M3U, *.PLS, *.WAV
- Non-English Album/Title name
- The discs recorded under Joliet format

Region codes

DVDs must be labeled for **ALL regions** or for **Region 5** in order to play on this system. You cannot play discs that are labeled for other regions.



Notes:

- For mixed mode discs, only one mode will be selected for playback according to the recording format.
- If you are having trouble playing a certain disc, remove the disc and try a different one. Improperly formatted discs will not play on this system.

Supplied accessories

- Composite video cable (yellow)
- Audio cables (white, red)
- Remote Control (with battery)
- This instruction booklet and a Quick Use Guide

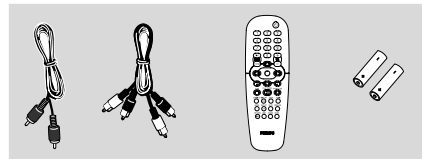

Environmental information

Any unnecessary packaging has been omitted. We have tried to make the packaging easy to separate into three materials: cardboard (box), polystyrene foam (buffer) and polyethylene (bags, protective foam sheet).

Your system consists of materials which can be recycled and reused if disassembled by a specialised company. Please observe the local regulations regarding the disposal of packaging materials, exhausted batteries and old equipment.

Care and safety information

Avoid high temperatures, moisture, water and dust

- Do not expose the system, batteries or discs to humidity, rain, sand or excessive heat (caused by heating equipment or direct sunlight). Always keep disc trays closed to avoid dust buildup on the lens.
- No objects filled with liquids, such as vases, shall be placed on the apparatus.
- No naked flame sources, such as lighted candles, should be placed on the apparatus.
- The apparatus shall not be exposed to dripping or splashing and no objects filled with liquids, such as vases, shall be placed on the apparatus.

Avoid condensation problem

- The lens may cloud over when the player is suddenly moved from cold to warm surroundings, making it impossible to play a disc. Leave the player in the warm environment until the moisture evaporates.

Do not block the vents

- Do not operate the system in an enclosed cabinet and allow about 10 cm (4 inches) of free space all around the player for adequate ventilation.

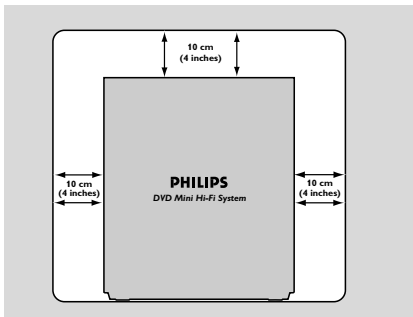

- The ventilation should not be impeded by covering the ventilation openings with items, such as newspapers table-cloths, curtains, etc.

Cleaning the cabinet

- Use soft cloth slightly moistened with a mild detergent solution. Do not use a solution containing alcohol, spirits, ammonia or abrasives.

Cleaning discs

- To clean a CD, wipe it in a straight line from the center towards the edge using soft and lint-free cloth. A cleaning agent may damage the disc.
- Write only on the printed side of a CDR(W) and only with a soft felt-tipped pen.
- Handle the disc by its edge. Do not touch the surface.



Cleaning the disc lens

- After prolonged use, dirt or dust may accumulate at the disc lens. To ensure good playback quality, clean the disc lens with Philips CD Lens Cleaner or any commercially available cleaner. Follow the instructions supplied with cleaner.

Finding a suitable location

- Place the player on a flat, hard, stable surface.
- Install this unit near the AC outlet and where the AC power plug can be reached easily.

Cleaning the head and the tape paths

- To ensure good recording and playback quality, clean the head (A), the capstan(s) (B), and pressure roller(s) (C) after every 50 hours of tape operation.
- Use a cotton swab slightly moistened with cleaning fluid or alcohol.
- You also can clean the head by playing a cleaning tape once.

Demagnetising the head

- Use a demagnetising tape available at your dealer.

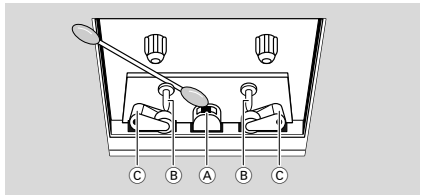

- When the system is switched to standby mode, it is still consuming some power. To disconnect the system from the power supply completely, remove the AC power plug from the wall sockets.
- Where the mains plug or an appliance coupler is used as the disconnect device, the disconnect device shall remain readily operable.

Connections

Step 1: Placing speakers

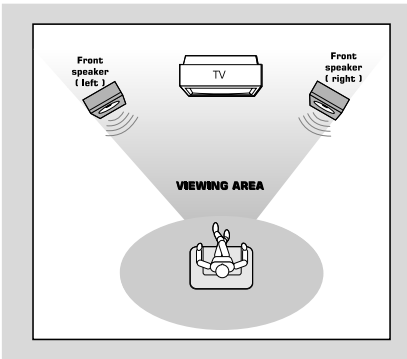

Place the front left and right speakers at equal distances from the TV set and at an angle of approximately 45 degrees from the listening position.

Notes:

- To avoid magnetic interference, do not position the front speakers too close to your TV set.
- Allow adequate ventilation around the DVD Mini Hi-Fi System.

Step 2: Connecting speakers

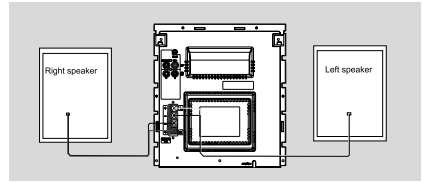

Connect the speaker wires to the SPEAKERS (FRONT) terminals, right speaker to "R" and left speaker to "L", coloured (marked) wire to "+" and black (unmarked) wire to "-". Fully insert the stripped portion of the speaker wire into the terminal as shown.

Speakers	⊖	⊕
Front Left (L)	Black	White
Front Right (R)	Black	Red

Notes:

- For optimal sound performance, use the supplied speakers.
- Do not connect more than one speaker to any one pair of +/- speaker terminals.
- Do not connect speakers with an impedance lower than the speakers supplied. Please refer to the SPECIFICATIONS section of this manual.

IMPORTANT!

The type plate is located on the rear of the system.

To avoid overheating of the system, a safety circuit has been built in. Therefore, your system may switch to Standby mode automatically under extreme conditions. If this happens, let the system cool down before reusing it.

Step 3: Connecting TV set

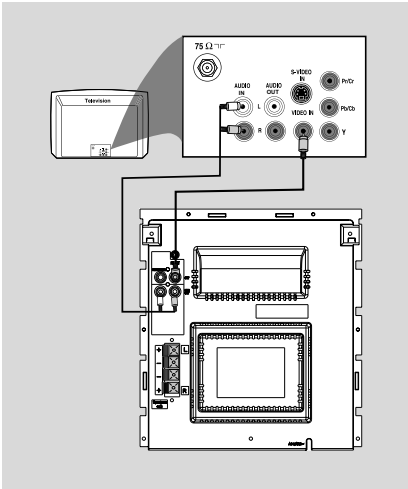

IMPORTANT!

– Connect the system directly to the TV set.

Using Video In jack (CVBS)

- Use the composite video cable (yellow) to connect the system's **VIDEO** jack to the video input jack (or labeled as A/V In, Video In, Composite or Baseband) on the TV set.

Using LINE OUT jack (L/R)

- To listen to this system channels through TV, use the audio cables (white/red) to connect **LINE OUT (L/R)** jacks to the corresponding AUDIO IN jacks on the TV set.

Step 4: Connecting the power cord

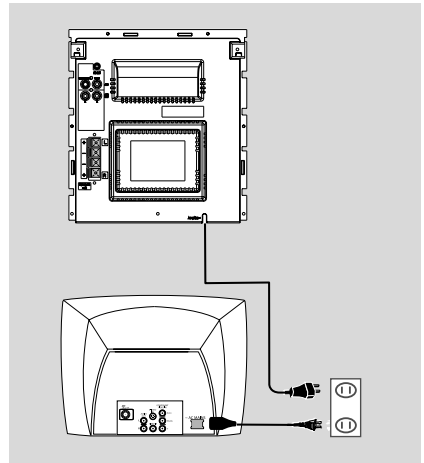

After everything is connected properly, plug in the AC power cord to the power outlet.

Never make or change any connection with the power switched on.

Functional Overview

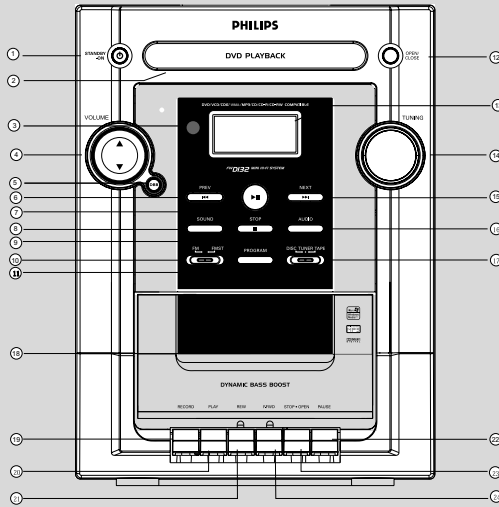

Controls on the system

- ① **STANDBY ON**
– to switch the system on or to standby mode.
- ② **DISCTRAY**
- ③ **iR**
– point the remote control towards this sensor.
- ④ **VOLUME (▼/▲)**
– to increase or decrease the volume.
- ⑤ **DBB**
– to enhance the bass response.
- ⑥/⑮ **PREV/NEXT (◀◀ / ▶▶)**
– to select previous/next title, chapter or track during playback.
– to skip to beginning of current title, chapter or track. (◀◀)
– to fast reverse/forward the disc.
- ⑦ **▶▶ (PLAY/PAUSE)**
– to start or interrupt playback.
- ⑧ **SOUND**
– to select various sound effects.
- ⑨ **STOP ■**
– to stop playback or to clear a programme.
- ⑩ **FM/FMST**
– For FM, to switch between Mono and Stereo.
- ⑪ **PROGRAM**
– to program favorite tracks.
- ⑫ **OPEN/CLOSE**
– to open or close the disc tray.
- ⑬ **DISPLAY SCREEN**
– to view the current status of the system.
- ⑭ **TUNING**
– to search for the desired station.
- ⑯ **AUDIO**
– to select an audio language
- ⑰ **DISC/TUNER/TAPE**
– To select the following:
DISC
– to select disc.
TUNER
– to select FM waveband.
TAPE
– to select tape deck.
- ⑱ **TAPE DECK**
- ⑲ **RECORD**
– to start recording on tape deck.
- ⑳ **PLAY**
– to start tape playback.
- ㉑ **REW**
– to rewind the tape.
- ㉒ **PAUSE**
– to interrupt tape playback.
- ㉓ **STOP/OPEN**
– to stop tape playback.
– to open the tape deck door (in stop mode).
- ㉔ **F.FWD**
– to fast forward the tape.

Remote control

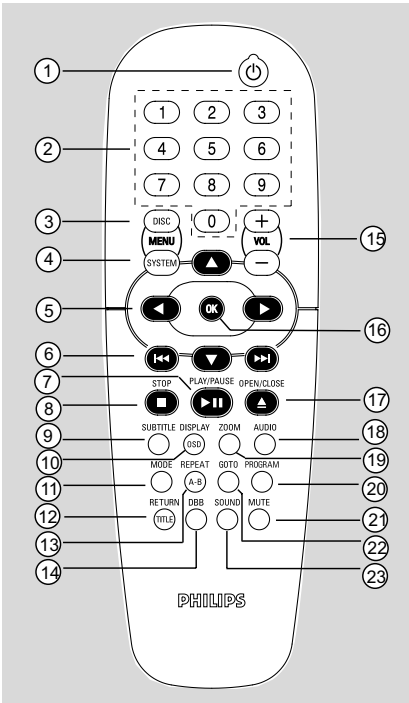

Notes:

- First, select the source you wish to control by pushing the source switch to one of the source on the panel (DISC or TUNER, for example).
- Then select the desired function (|◀◀ or ▶▶| for example).

- ①
 - to switch the system on or to standby mode.
- ② **Numeric Keypad (0-9)**
 - to enter a track/title number of the disc.
- ③ **DISC MENU (disc mode only)**
 - to enter or exit the disc contents menu.
- ④ **SYSTEM MENU (disc mode only)**
 - to enter or exit the system menu.
- ⑤
 - to select movement direction in disc contents menu/system menu.
 - to select the slow speed. (/)
- ⑥
 - to skip to the previous/next chapter/track.
 - to skip to beginning of current title, chapter or track. ()
 - to fast reverse/forward the disc.
- ⑦ **PLAY/PAUSE**
 - to start or interrupt disc playback.
 - to resume playback from last stop point.
- ⑧ **STOP**
 - to stop playing the disc.
- ⑨ **SUBTITLE**
 - to select desired subtitle.
- ⑩ **DISPLAY (OSD)**
 - to view the time, title or chapter information.
- ⑪ **MODE**
 - to select REPEAT or SHUFFLE function.
- ⑫ **RETURN/TITLE**
 - to return to previous title menu.(for DVD only)
 - to return to PBC menu or main menu.(for VCD with PBC on).
- ⑬ **REPEAT A-B**
 - to repeat a specific section on a disc.
- ⑭ **DBB**
 - to settings to enhance the bass response.
- ⑮ **VOL +/-**
 - adjust the volume level.
- ⑯ **OK**
 - to exit or confirm the selection.
- ⑰ **OPEN/CLOSE**
 - to open or close the disc tray.
- ⑱ **AUDIO**
 - to select the audio channel.
- ⑲ **ZOOM**
 - to access the Zoom function.
- ⑳ **PROGRAM**
 - to program favorite tracks.
- ㉑ **MUTE**
 - to interrupt or resume sound reproduction.
- ㉒ **GOTO**
 - to go directly to desired title, chapter or time.
- ㉓ **SOUND**
 - to select various sound effects.

Preparations

IMPORTANT!

– Make sure to complete the preparation procedures before operating the system.

Step 1: Inserting batteries into the remote control

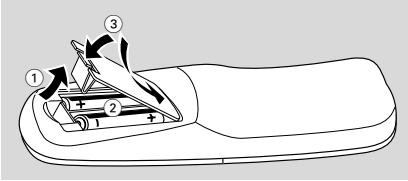

- 1 Open the battery compartment.
- 2 Place two batteries (Type R06 or AA) in the compartment with the correct polarity as indicated by "+" and "-" symbols.
- 3 Close the cover.

Using the remote control to operate the system

- 1 Point the remote control directly at the remote sensor (IR) on the front panel.
- 2 Select the source you wish to control by pushing the source switch on the front panel to one of the source (for example DISC, TAPE, TUNER).
- 3 Then select the desired function (for example **▶|||◀◀** or **▶▶|◀**).

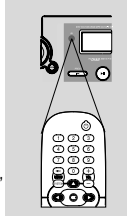

CAUTION!

– Remove batteries if they are exhausted or will not be used for a long time.
 – Do not use old and new or different types of batteries in combination.
 – Batteries contain chemical substances, so they should be disposed of properly.

Step 2: Setting the TV set

IMPORTANT!

– Make sure you have completed all the necessary connections.

- 1 Push the source switch on the front panel to **DISC**.
- 2 Turn on the TV set and set to the correct Video-In channel. You should see the blue Philips DVD background screen on the TV set.
 → You may go to channel 1 on your TV set, then press the channel down button repeatedly until you see the Video In channel.
 → Or, you can use the TV remote control to select different video modes.

Selecting the color system that matches your TV set

This DVD Mini Hi-Fi System is compatible with both NTSC and PAL. For the playback of a DVD disc on this DVD Mini Hi-Fi System, the color systems of the DVD, TV set and DVD Mini Hi-Fi System should match.

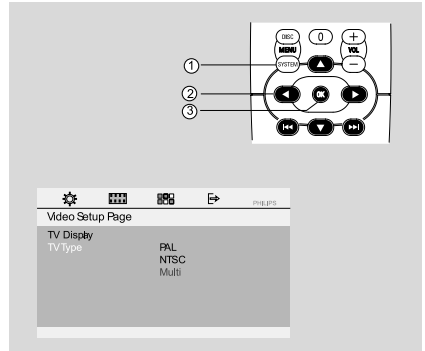

- 1 In disc mode, press **SYSTEM MENU**.
- 2 Press **◀ / ▶ / ▲ / ▼** keys on the remote control to select your preferred option.
 → Move to "Video Setup Page" and press **▼**.
 → Move to "TV Type" and press **▶**.

PAL

– Select this if the connected TV set is PAL system. It will change the video signal of an NTSC disc and output to PAL format.

NTSC

– Select this if the connected TV set is NTSC system. It will change the video signal of a PAL video disc and output to NTSC system.

Multi

– Select this if the connected TV set is compatible with both NTSC and PAL (multi system). The output format will be consistent with the video signal of the disc.

- 3 Select an item and press **OK**.

To remove the menu

Press **SYSTEM MENU**.

Step 3: Setting language preference

You can select your preferred language settings so that this DVD Mini Hi-Fi System will automatically switch to the language for you whenever you load a disc. If the language selected is not available on the disc, the language set by default will be used instead. But the menu language of the DVD Mini Hi-Fi System cannot be changed once selected.

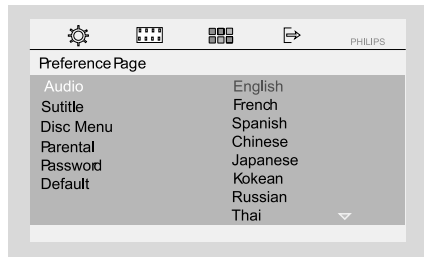

- 1 In disc mode, stop playback and press **SYSTEM MENU**.
- 2 Press **◀** / **▶** / **▲** / **▼** keys on the remote control to select your preferred option.
 - Move to "Preference Page" and press **▼**.
 - Move to one of the following and press **▶**.
 - Audio (disc's soundtrack)
 - Subtitle (disc's subtitles)
 - Disc Menu (on screen menu)
- 3 Press **▲** / **▼** to select a language and press **OK**.
- 4 Repeat **steps 2~3** for other settings.

To remove the menu

Press **SYSTEM MENU**.

Basic Functions

Switching on/off

Switching the system ON

In Standby

- Press **STANDBY ON**
→ The system will go back to its previous status.

Switching the system to STANDBY mode

In any other source mode

- Press **STANDBY ON** (or  on the remote control).

Power saving automatic standby

As a power-saving feature, the system will automatically switch to Standby mode if you don't press any button within 15 minutes in the stop mode.

Sound control

Selecting sound effect

The digital sound effect allows you to select from various preset modes that control the frequency bands of sound to optimize certain musical styles. It greatly enhances the excitement and enjoyment of your favorite music.

- Press **SOUND** repeatedly to select the available sound effect.

Playing a DVD/VCD/SVCD

- You can select Virtual Ambience Control as follows:
 - CONCERT, ACTION, DRAMA, SCI-FI.

Playing a CD/CDG/MP3/JPEG/TUNER/TAPE

- You can select Digital Sound Control:
 - TECHNO, ROCK, JAZZ, OPTIMAL.

Selecting DBB effect

To enhance the bass response, press DBB once or more to select your option: **DBB ON**, **DBB OFF**.

Volume control

Changing the volume level

- Press **VOLUME ▼/▲** (or **VOL +/-** on the remote control) to increase or decrease the master volume level.
→ The range is from 0 dB to 40 dB and the step is 1dB.

Switching off the volume temporarily

- Press **MUTE**.
→ "MUTE" is displayed on the TV.
Press **MUTE** again or adjust the volume level to cancel the MUTE mode.
→ "MUTE OFF" is displayed on the TV.

Disc Operations

IMPORTANT!

- This system is designed for regular discs. Therefore, do not use any accessories such as disc stabiliser rings or disc treatment sheets, etc., as offered on the market, because they may jam the disc mechanism.
- Do not move the system during playback. Doing so may damage the system.
- Do not push on the disc tray or put any object other than disc on the disc tray. Doing so may cause the system to malfunction.
- DVD discs and players are designed with regional restrictions. Before playing a disc, make sure the disc matches the regional code of your player.
- According to the format requirement of DVD or VCD, some operations may be different or restricted.

Playing discs

- 1 Press **STANDBY ON**  to switch on the system, and push the source switch to select disc mode.
- 2 Power on the TV system and set to the correct Video In channel.
 - You should see the blue Philips DVD background screen on the TV set.
- 3 Press **OPEN/CLOSE** to open the disc tray and load a disc.
 - Make sure the disc label is facing up. For double-sided discs, load the side you want to play facing up.

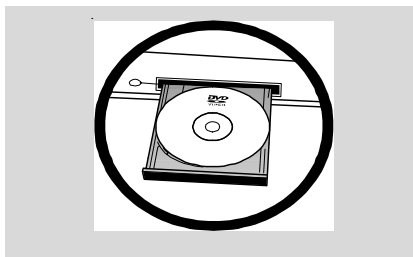

- 4 Press **OPEN/CLOSE** to close the disc tray.
 - "L.O.F.F." will be displayed.

- Some discs can play automatically. For discs with Table Of Contents, a menu may appear on the TV screen. When the menu is displayed, press **◀ / ▶ / ▲ / ▼** keys to highlight your selection and press **OK** to confirm. To select a play option, press **numeric keys (0-9)**.
 - If the disc is locked by parental control, you must enter your six-digit password .
- 5 Press **▶II** to start playback.

For MP3/WMA

- Load an MP3/WMA disc in the disc tray.
 - Press **DISC MENU** to select folder, filelist or playlist menu.

Notes:

- Load discs with the label side facing up.
- To ensure good system performance, wait until disc reading is completed before proceeding.

Using the disc menu

For disc with Table Of Contents, a menu may appear on the TV screen once you load the disc.

To select a playback feature or item

- Press **◀ / ▶ / ▲ / ▼** or **numeric keys (0-9)** on the remote control, then press **▶II** or **OK** to start playback.

To access or remove the menu

- Press **DISC MENU** on the remote control.

Basic playback controls

To start playback

- Press **▶II**.

To interrupt playback

- Press **▶II**.
- To resume playback, press **▶II** again.

To stop playback

- Press **■**.

Disc Operations

Skipping to another title (track)/chapter

For DVD/VCD

- During playback, press **I◀◀** to playback the beginning of the current title (track)/chapter; press **I◀◀** twice in 2 seconds to skip to previous title (track)/chapter; and press **▶▶I** to skip to next title (track)/chapter.

For MP3/WMA/JPEG

- Press **I◀◀** or **▶▶I** on the front panel or on the remote control repeatedly during playback to skip to previous or next track.

Note:

- Each press will take the disc to the beginning of the previous or next title (track)/chapter.
- If the player has been set to repeat chapter (track), pressing this button will replay the same chapter (track) from its beginning.

To go directly to any title (track) / chapter

For CD/VCD/MP3/WMA

- Use the **numeric keys (0-9)** to enter the number of the desired track.

For DVD

- Please see “Moving to another title/chapter”.

Fast search

- 1 Press and hold **I◀◀** or **▶▶I** on the front panel or remote control to fast reverse or forward the disc.
- 2 To resume normal play, press **▶▶II**.

Continuing playback from the last stop point

- During playback, press **■** once to stop the playback in resume mode, then press **▶▶II** to resume playback from where you have stopped.

To cancel the resume mode

- Press **■** again, or go into **STANDBY** or press **OPEN/CLOSE** key.

Notes:

- Resume information will be erased if you have changed the disc, opened the disc tray, changed source or disconnected the system from the power supply.
- This function is not available for MP3/WMA disc.

Selecting various mode functions

Repeat play / Shuffle play mode

You can select the Repeat play and Shuffle play mode during playback.

For DVD

- Press **MODE** repeatedly to select the following: REPEAT CHAPTER → REPEAT TITLE → REPEAT ALL → SHUFFLE → SHUFFLE REPEAT → REPEAT OFF

For SVCD/VCD(PBC OFF)/CD

- Press **MODE** repeatedly to select the following: REPEAT TRACK → REPEAT ALL → SHUFFLE → SHUFFLE REPEAT → REPEAT OFF

For MP3/WMA

In folder menu:

- Press **PLAYMODE** repeatedly to select the following: REPEAT ONE → REPEAT FOLDER → SHUFFLE → FOLDER(REPEAT OFF)
In filelist/playlist menu:
- Press **MODE** repeatedly to select the following: REPEAT ONE → REPEAT ALL → SHUFFLE → REPEAT OFF

In shuffle playback mode:

- Press **▶▶I** button to select another track in a shuffle order.
- Press **■** to stop shuffle playback.

To cancel Shuffle mode:

- Press **MODE** repeatedly to select “REPEAT OFF” to cancel Shuffle mode.

Notes:

- In Tuner or Tape mode, this button does not function.
- When the disc tray is opened, shuffle/repeat function will be cancelled automatically.

Repeating a section within a chapter/track

You can play a specific section in a chapter/track repeatedly.

- 1 Press **REPEAT A-B** at your chosen start point.
- 2 Press **REPEAT A-B** again at your chosen end point.
→ The passage will now repeat continuously.
- 3 To resume normal play, press **REPEAT A-B** again.

Note:

– The **REPEAT A-B** function can only be set within the same chapter or track.

Programming favorite Chapters/tracks

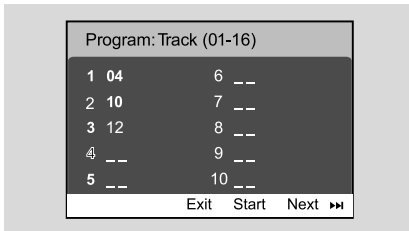

You can play the contents of the disc in the order you want.

For DVD/VCD/SVCD/CD/CDG

- 1 Press **PROGRAM** on the remote control.
→ The programming menu appears.
- 2 Use the **numeric keys (0-9)** to input the track /chapter number in the order you want. (must enter two-digit, such as 06).
→ If there are more than ten programmed tracks, select **{NEXT}** on the screen and press **OK** (or press **►►** on the remote control) to access the next programming page.
→ To remove the track/chapter from the programming menu, select the track/chapter and press **OK**.

- 3 Select **{Start}** to play the program.
- 4 To stop playback, press **■** once.
- 5 To exit the program mode, press **■** again.

For MP3/WMA/JPEG

- 1 Press **▲ / ▼** to select a track/picture on the disc menu, and then press **PROGRAM** to add the track/picture to playlist.
→ "Add To Playlist" will show on the disc menu.
- 2 Press **DISC MENU** repeatedly to select playlist menu.
- 3 Press **▲ / ▼** to select a track/picture and press **OK** to start playback.
→ You can select a track/picture and press **PROGRAM** to move it from the playlist.
- 4 Press **STOP** to stop program playback .

Notes:

– At most 20 tracks can be stored for DVD/VCD/SVCD/CD/CDG.

– At most 100 tracks can be stored for MP3/WMA/JPEG.

Special DVD/VCD features

Changing subtitle language

This operation only works on DVDs with multiple subtitle languages.

- Press **SUBTITLE** to select the desired language.

Changing picture scales

This operation only works on VCDs/DVDs/JPEGs with images.

For VCD/DVD:

- Press **ZOOM** to change the zooming scale:
ZOOM X2 → ZOOM X3 → ZOOM X4
→ ZOOM X1/2 → ZOOM X1/3 → ZOOM X1/4 → (ZOOM OFF)...

Disc Operations

For JPEG:

- Press **ZOOM** to change the picture zooming scale:
ZOOM X100% → ZOOM X125% → ZOOM X150% → ZOOM X200% → ZOOM X75% → ZOOM X50% → (ZOOM OFF)...
- To pan through the enlarged image, press ◀ / ▶ / ▲ / ▼ buttons to move the zoomed picture left, right, up or down.
- Press **ZOOM** repeatedly to exit ZOOM mode.

Changing sound track language

This operation only works on DVDs with multiple audio languages.

- Press **AUDIO** to select the desired language.

For VCD:

- Press **AUDIO** to select the desired audio channels for sound. This function is only available for discs recorded with different channels:
MONO LEFT → MONO RIGHT → MIX-MONO → STEREO

Note:

– If your desired language is not set in the disc, you cannot select the language via this function.

Searching for a particular passage

- 1 Press and hold |◀◀ or ▶▶| repeatedly to select fast reverse search or fast forward search respectively.
- 2 Press and hold |◀◀ or ▶▶| repeatedly to select the required search speed:
(forward): ▶▶ 2X → ▶▶ 4X → ▶▶ 8X → ▶▶ 16X → ▶▶ 32X → (PLAY)...
(reverse): ◀◀ 2X → ◀◀ 4X → ◀◀ 8X → ◀◀ 16X → ◀◀ 32X → (PLAY)...

Playing in slow motion mode

For DVD

- 1 Press ▲ repeatedly to select the required slow reverse speed:
◀1/2 → ◀1/4 → ◀1/8 → ◀1/16 → ▶ PLAY...
- 2 Press ▼ repeatedly to select the required slow forward speed:
▶1/2 → ▶1/4 → ▶1/8 → ▶1/16 → ▶

PLAY...

For VCD

- 2 Press ▼ to select the required slow forward speed:
▶1/2 → ▶1/4 → ▶1/8 → ▶1/16 → ▶ (PLAY)...
- 3 Press ▶|| to cancel the slow function.

Note:

– This function is not available for CD or MP3/WMA disc.

Displaying the disc information during playback

- In disc mode, press **DISPLAY/OSD** repeatedly to select the following display information:

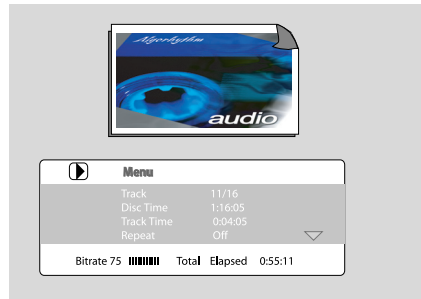

Viewing from another angle

If the playing DVD disc is recorded with multiple camera angles, you can view the picture from different angles. Angle selection is determined by the disc format.

- 1 Press **DISPLAY/OSD** to display the disc message.
- 2 Use ▲/▼ to highlight "Angle" and press **OK**.
- 3 Use **numeric keys (0-9)** to select a desired angle.
→ Playback changes to the selected angle.

Moving to another title/chapter

Some discs may contain more than one title or chapter. If the disc has a title or chapter menu recorded on it, you can start playback from the selected item.

- 1 Press **DISPLAY/OSD** on the remote control to display the message of title and chapter:
- 2 Use **▲ / ▼** to highlight a title/chapter item and press **OK**.
- 3 Use **numeric keys (0-9)** to select a desired title/chapter number.
- 4 Press **DISPLAY/OSD** to exit the disc information menu.

Note:

– *Selecting a title or chapter might not be possible on certain discs.*

Playing from a selected point

This function allows you to start playback at any chosen time on the disc.

For DVD

- 1 Press **GOTO** to activate time menu, the TV screen will display:
Title:XX/XX Chapter:_/XX
Title:XX/XX Time _: _: _
Chapter:XX/XX Time _: _: _
→ You can press **◀ / ▶** to highlight the title item and use the numeric keys to select desired title.
- 2 Enter hours, minutes and seconds from left to right in the time edit box using the **numeric keys (0-9)**.

For SVCD, VCD or CD

- 3 Press **GOTO** to activate time menu, the TV screen will display:
Disc Go to: _: _: _
Track Go to: _: _: _
Select Track : _/XX
- 4 Enter minutes and seconds from left to right in the time edit box using the **numeric keys (0-9)**. Then it will start playback.

For MP3 or WMA

- 5 Press **GOTO** and use **numeric keys (0-9)** to enter your choice to playback.

Note:

– *In repeat disc or repeat all mode, you can search a desired time point.*

Playback control (PBC)

PBC playback allows you to play Video CD interactively, following the menu on the display.

- Press **DISC MENU** to toggle between PBC ON and PBC OFF.

Playing a disc with PBC function

- If PBC is OFF, the system will start playback automatically.
- If PBC is ON, the PBC menu (if available) will appear on the TV screen for selection. Use the **numeric keys (0-9)** to enter your choice.

Note:

– *This function is not available for DVD/CD/MP3/WMA disc.*

Checking the contents of DVD

- 1 Press **DISC MENU** on the remote control.
→ If the current title has a menu, the menu will appear on the screen. Otherwise, the disc menu will be displayed.
- 2 Press **◀ / ▶ ▲ / ▼** to select the desired title or chapter; and then press **▶II** or **OK**.
→ Playback start from the selected title or chapter.
- 3 Press **DISC MENU** on the remote control to go to disc menu of the disc.

Note:

– *If no title menu or root menu is recorded in the DVD disc, pressing this button will restart playback from the first track.*

MP3/ Picture Disc Operations

Playing MP3/Picture disc (Kodak, JPEG)

IMPORTANT!

– You have to turn on your TV set and set to the correct Video In channel.

MP3/JPEG Picture disc

- 1 Load an MP3/Picture (JPEG) disc.
→ The disc reading time may exceed 30 seconds due to complexity of the directory/file configuration.
→ The disc menu appears on the TV.
- 2 Select a track in the menu and press **OK** to start playback.



- 3 During music playback, press **▲** / **▼** or use the **numeric keys (0-9)** to select a desired picture file from the disc menu and press **OK**.
→ If the disc main menu contains various folders, use **▲** / **▼** to select a desired folder; and press **OK** to open the folder.
- 4 Press **⏪** or **⏩** on the system to select previous/next track.
- 5 To stop simultaneous playback, press **DISC MENU** followed by **STOP**.
- 6 During JPEG or Kodak Picture disc playback, press **PROGRAM** repeatedly to select different scan effects. There are 12 types of scan effects for selection. The selected scan effect will be displayed on the TV screen.

Kodak Picture disc

- 1 Load a Kodak Picture disc.
→ The disc reading time may exceed 30 seconds due to complexity of the directory/file configuration.
- 2 During playback, press **■**.

→ 12 thumbnail pictures will appear on the TV screen.

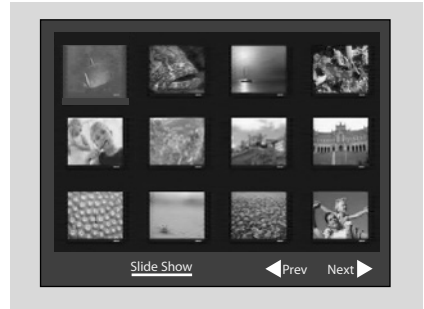

- 3 Press **⏪** / **⏩** to view the previous/next page (if available).
- 4 Press **◀** / **▶** / **▲** / **▼** to move within the menu and press **OK** to select the desired picture to play.
- 5 Press **PROGRAM** to select the slide-show mode.

During playback, you can:

- Press **⏪** or **⏩** to select another track/picture in the current folder.
- Press **◀** / **▶** / **▲** / **▼** on the remote control to rotate or flip the picture files.
- Press **ZOOM** repeatedly to zoom the picture in and out.
- Press **⏸** to pause/resume playback.

Notes:

- Due to the recording nature of Digital Audio MP3 (DAM), only digital audio music will play.
- It is normal to experience an occasional "skip" while you are listening to your MP3 discs.
- For multi-session discs with different formats, only the first session can be read and played.

DVD Menu Operations

Using the setup menu (user preference settings)

This DVD setup is carried out via your TV set, enabling you to customize the DVD Mini Hi-Fi System to suit your particular requirements.

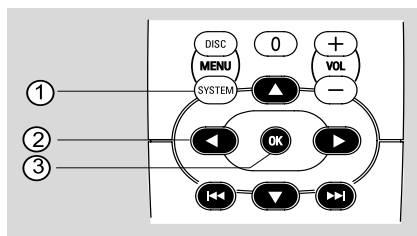

- In disc mode, press **SYSTEM MENU**.
→ The setup menu will appear on the TV screen.
→ Playback will pause.



- Press **◀ / ▶ / ▲ / ▼** on the remote control to navigate in the menu.
- Press **OK** to confirm your selection.

Removing the menu

Press **SYSTEM MENU**.

Setting the TV Display

Make sure the format you need is available on the disc. If not, your setting will be invalid.

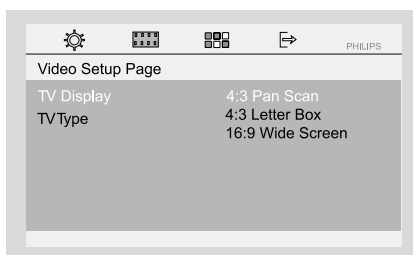

4:3 Pan Scan

Select this if you have a conventional TV set and your DVD is not formatted for wide screen viewing. A wide picture will display on the whole TV screen with a portion automatically cut off.

4:3 Letter Box

Select this if you have a conventional TV set and your DVD is formatted for wide screen viewing. Black bars appear on the upper and lower portions of the TV screen.

16:9 Wide Screen

Select this if you have a wide-screen TV set (you must also set your wide screen TV to "full size").

16:9 Wide Screen

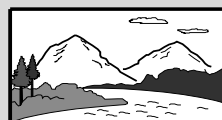

4:3 Letter Box



4:3 Pan Scan

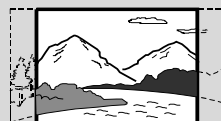

DVD MeLnu Operations

Setting the screen saver

If set to ON, the screen saver will be activated when you leave the system in stop or pause mode for 5 minutes. The default setting is ON.

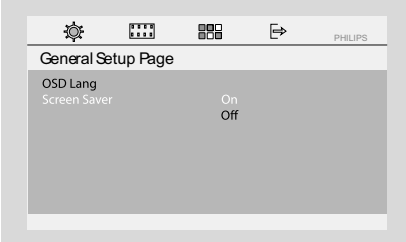

Changing the password

You can change the six-digit code used as Password.

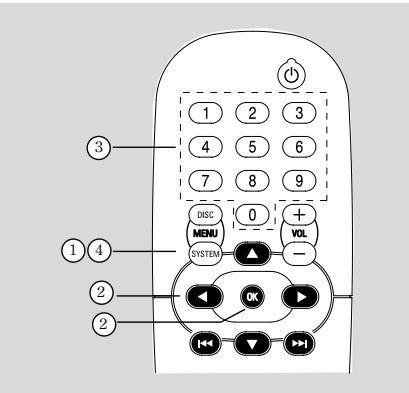

- 1 In disc stop mode, press **SYSTEM MENU**.
- 2 Press ◀ / ▶ / ▲ / ▼ on the remote control to navigate in the menu.

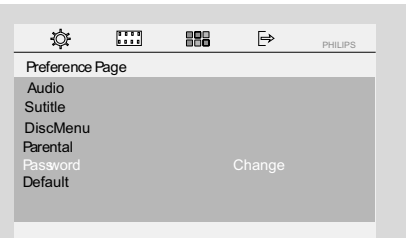

- Move to "Preference Page" and press ▼.
- Move to "Password" and press ▶.
- Move to "Change" and press **OK**.

- 3 Use the **numeric keys (0-9)** to enter your six-digit code.
 - The password supplied by default is 000000.
 - If you forget your existing password, key in "136900".
- 4 Go to "Password" and enter your new code. Then, enter the same code again to confirm.

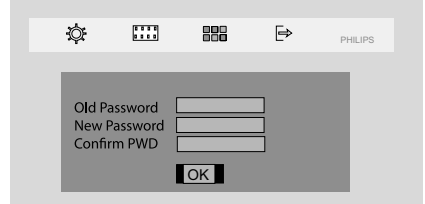

- 4 Press **SYSTEM MENU** again to remove the menu.

DVD Menu Operations

Restricting playback by setting parental level

Some DVDs may have a parental level assigned to the complete disc or to certain scenes on the disc. This feature lets you set a playback limitation level. The rating levels are from 1 to 8 and are country specific. You can prohibit the playing of certain discs that are not suitable for your children or have certain discs played with alternative scenes.

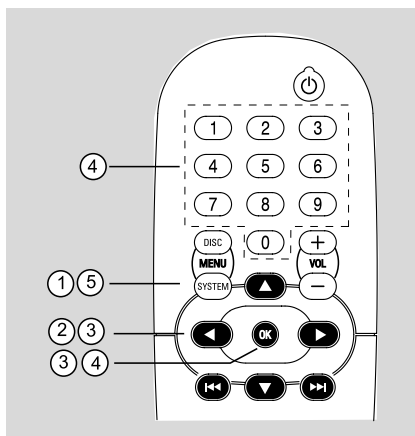

- 1 In disc stop mode, press **SYSTEM MENU**.
- 2 Use **◀/▶/▲/▼** on the remote control to navigate in the menu.
→ Move to "Preference Page" and press **▼**.
→ Move to "Parental" and press **▶**.

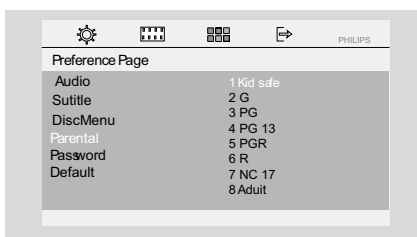

- 3 Press **▲/▼** to select a rating level between 1-8 and press **OK**.
→ DVDs rated above the level you select will not play unless you enter your six-digit password or choose a higher level rating.

- 4 Use the **numeric keys (0-9)** to enter the six-digit code, and press **OK**.
- 5 Press **SYSTEM MENU** again to remove the menu.

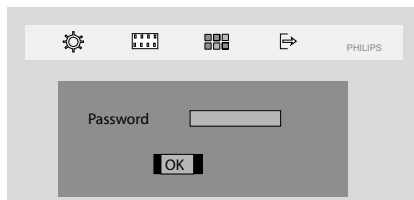

Rating explanations

8 ADULT – material for adults only; viewed only by adults due to graphic sexual scenes, violence, or language.

7 NC-17 – No children under age 17; not recommended for children under age 17.

5-6 PG-R – Parental Guidance – Restricted; recommended that parents restrict children under 17 from viewing or allow them to view only when supervised by a parent or adult guardian.

4 PG 13 – Material is unsuitable for children under age 13.

3 PG – Parental Guidance suggested.

2 G – General Audience; recommended as acceptable for viewers of all ages.

1 KID SAFE – Kids material; recommended especially for children and viewers of all ages.

– OSD Lang

To set the screen display language. The default setting is English.

– Default

If **RESET** is selected, all the items in the setup menu will be reset to default setting, except Parental Setting and Password.

Tuner Operations

Tuning to radio stations

- 1 Push the source switch to **TUNER**.
- 2 Turn the **TUNING** knob on the system until the frequency indication starts to change.
→ The current radio frequency will appear on the display.
- 3 To tune to a weak station, turn the **TUNING** knob to search until a radio station with sufficient signal strength is found.

Notes:

- The FM antenna is fixed in the system.

Tape Operation/Recording

IMPORTANT!

- Before playing a tape, check and tighten slack tape with a pencil. Slack tape may get jammed or may burst in the mechanism.
- Store tapes at room temperature and do not put them too close to a magnetic field (for example, a transformer, TV set or speaker).

Tape playback

- Only cassette keys can be used for tape playback control.
- 1 Press **■▲** to open the tape deck door.
- 2 Insert a recorded tape and close the tape door:

Top view of cassette key



- Load the tape with the open side down and the full spool to the left.

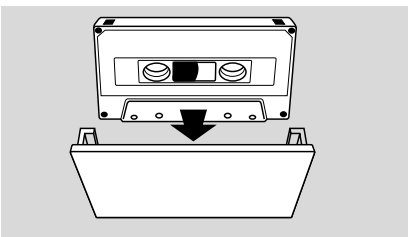

- 3 Push the source switch to select tape mode.
- 4 Press **▶** to start playback.

Interrupting playback

- Press **||** to interrupt playback.

Stopping playback

- Press **■▲** to stop playback.

Rewinding or forwarding fast when playback is stopped

- 1 Press **◀◀** or **▶▶** on the front panel.
- 2 Press **■▲** when you reach the desired passage.

Tape Operation/Recording

General information on recording

- For recording, only use tape of IEC type I (normal tape).
- The recording level is set automatically, regardless of the position of the Volume, Vocal, Key control and so forth.
- The type is secured at both ends with leader tape. At the beginning and end of the tape, nothing will be recorded for seven seconds.
- To prevent accidental recording, break out the tab on the left shoulder of the tape side you want to protect.

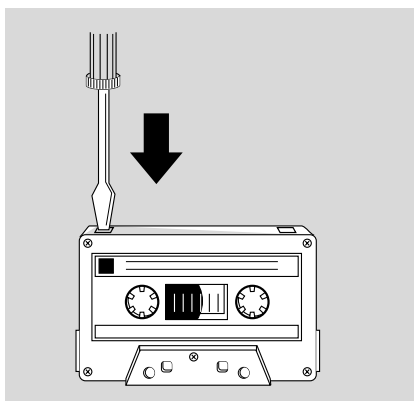

- Press ● in Disc or Tuner mode, the record key can't be pressed if there is no recordable tape in tape deck.

IMPORTANT!

- Recording is permissible if copyright or other rights of third parties are not infringed upon.
- Recording is possible only in tape deck.

Preparation for recording

- 1 Load a recordable tape into tape deck with the full spool to the left.
- 2 Prepare the source to be recorded.
DISC – load the disc.
TUNER – tune to the desired radio station.
- 3 Push the source switch to select the source.
- 4 Start to play the selected source.
- 5 Press ● to start recording.

To stop recording

- Press ■▲ on the system.

Disc synchro recording

- 1 Switch the source to disc mode.
- You can record programmed tracks in the order you want.
- 2 Press ● to start recording.
→ "REC" will flash, but the first 7 seconds of the start passage will not be recorded.

Selecting another track during recording

- 1 Press II to interrupt recording.
- 2 Press I◀◀ / ▶▶I to select another track.
- 3 Press II to resume recording.

To stop recording

- Press ■▲.

Specifications

AMPLIFIER

Output power 1200 W PMPO
2.0 CH mode 2 X 30W RMS
Frequency Response . 100 Hz - 10 kHz / \pm 3 dB
Signal-to-Noise Ratio > 62dB (A-WEIGHED)
Output Sensitivity
Line Out 2_{\pm} 0.2 V

TUNER

Tuning Range
..... FM 87.5 – 108 MHz
Signal-to-Noise Ratio FM \geq 50 dB

TAPE

Frequency Response
Normal tape 125Hz – 8KHz / \pm 4dB
Signal-to-Noise Ratio
Normal tape \geq 45 dBA
JIS and WTD \leq 0.35%

DVD

Laser Type Semiconductor
Video Decoding MPEG-2 / MPEG-1
Video DAC 12 Bits
Signal System PAL / NTSC
Video Format 4:3 / 16:9
Video S/N 56 dB (minimum)
Composite Video Output 1.0Vp-p, 75 Ω
Audio DAC 24 Bits / 96 kHz
Frequency Response .. 4 Hz - 20 kHz (44.1 kHz)
..... 4 Hz - 22 kHz (48 kHz)
..... 4 Hz - 44 kHz (96 kHz)

MAIN UNIT

Power Supply Rating 110-240 V~50-60Hz
Power Consumption
Active 50 W
Standby \leq 10W
Dimensions (w x d x h) 220 x 284 x 292 (mm)
Weight 2.77 kg
Packaging Dimensions (w x d x h)
..... 510 x 416 x 350 (mm)
Gross weight 8.4 kg

SPEAKERS

Front speakers
System full range satellite
Impedance 4 Ω
Speaker drivers 10cm full range speaker
Frequency response 50 Hz – 20 kHz
Dimensions (w x d x h)
..... 190 x 180 x 292 (mm)
Weight 1.86 kg/each

Specifications subject to change without prior notice

WARNING

Under no circumstances should you try to repair the system yourself, as this will invalidate the warranty. Do not open the system as there is a risk of electric shock.

If a fault occurs, first check the points listed below before taking the system for repair. If you are unable to remedy a problem by following these hints, consult your dealer or Philips for help.

Problem	Solution
No power.	<ul style="list-style-type: none"> ✓ Check if the AC power cord is properly connected.
“NO DISC” is displayed.	<ul style="list-style-type: none"> ✓ Check if the disc is inserted upside down. ✓ Wait until the moisture condensed at the lens has cleared. ✓ Replace or clean the disc, see “Maintenance”. ✓ Use a readable disc or correctly recorded format MP3-CD.
No picture.	<ul style="list-style-type: none"> ✓ Select the appropriate video input mode on the TV set. ✓ Check if the TV set is switched on. ✓ Check the video connection. ✓ Check if the system is securely connected.
Distorted or poor picture.	<ul style="list-style-type: none"> ✓ Sometimes a slight picture distortion may appear. This is not a malfunction. ✓ Clean the disc.
The aspect ratio of the screen cannot be changed even though you have set the TV shape.	<ul style="list-style-type: none"> ✓ The aspect ratio is fixed on the DVD disc. ✓ The aspect ratio may not be changed for some TV systems.
The DVD player does not start playback.	<ul style="list-style-type: none"> ✓ Insert a readable disc. ✓ Check the disc type, color system and region code. ✓ Clean the disc. ✓ Place the disc with the playback side down. ✓ Press SYSTEM MENU to turn off the setup menu. ✓ Cancel the parental control rating function or change the rating level. ✓ Moisture has condensed inside the system. Remove the disc and leave the system turned on for about an hour.
The system does not respond when the buttons are pressed.	<ul style="list-style-type: none"> ✓ Disconnect the power plug from the jack, and insert again.

Troubleshooting

Problem	Solution
The language for the sound or subtitle cannot be changed when playing a DVD.	<ul style="list-style-type: none"> ✓ Multi-language sound or subtitle is not recorded on the DVD. ✓ Changing the language for the sound or subtitle is prohibited on the DVD.
No image is output when a function is selected.	<ul style="list-style-type: none"> ✓ Make sure the component is connected correctly. ✓ Press the correct function button for the input source.
Sound cannot be heard or is of poor quality	<ul style="list-style-type: none"> ✓ Adjust the volume. ✓ Check that the speakers are connected correctly. ✓ Check if the stripped speaker wire is clamped. ✓ If the system is in pause, slow motion or fast forward/reverse mode, press ► to resume the normal play mode. ✓ Make sure the MP3-CD was recorded within 32-256 kbps bit rate with sampling frequencies at 48 kHz, 44.1 kHz or 32 kHz.
Poor radio reception.	<ul style="list-style-type: none"> ✓ If the signal is too weak, adjust the antenna or connect an external antenna for better reception. ✓ Increase the distance between the System and your TV set or VCR.
Recording or playback cannot be made	<ul style="list-style-type: none"> ✓ Clean deck parts, see "Maintenance". ✓ Use only NORMAL tape. ✓ Apply a piece of adhesive tape over the missing tab space.
The tape deck door cannot open	<ul style="list-style-type: none"> ✓ Remove and reconnect the AC power plug and switch on the system again.
Left and right sound outputs are reversed.	<ul style="list-style-type: none"> ✓ Check the speaker connections and location.
The remote control does not function.	<ul style="list-style-type: none"> ✓ Select the correct source (DISC or USB for example) before pressing the function button. ✓ Point the remote control at the remote control sensor of the unit. ✓ Reduce the distance to the player. ✓ Remove any possible obstacles. ✓ Replace the batteries with new ones. ✓ Check that the batteries are loaded correctly.

Analog: Sound that has not been turned into numbers. Analog sound varies, while digital sound has specific numerical values. These jacks send audio through two channels, the left and right.

Aspect ratio: The ratio of vertical and horizontal sizes of a displayed image. The horizontal vs. vertical ratio of conventional TVs is 4:3, and that of wide-screens is 16:9.

AUDIO OUT Jacks: Jacks on the back of the DVD System that send audio to another system (TV set, Stereo, etc.).

Bit Rate: The amount of data used to hold a given length of music; measured in kilobits per second, or kbps. Or, the speed at which you record. Generally, the higher the bit rate better the sound quality. However, higher bit rates use more space on a Disc.

Chapter: Sections of a picture or a music piece on a DVD that are smaller than titles. A title is composed of several chapters. Each chapter is assigned a chapter number enabling you to locate the chapter you want.

Component Video Out Jacks: Jacks on the back of the DVD System that sends high-quality video to a TV set that has Component Video In jacks (R/G/B, Y/Pb/Pr, etc.).

Disc menu: A screen display prepared for the selection of images, sound, subtitles, multi-angles, etc recorded on a DVD.

Dolby Digital: A surround sound system developed by Dolby Laboratories containing up to six channels of digital audio (front left and right, surround left and right and center).

JPEG: A still-picture data compression system proposed by the Joint Photographic Expert Group, which features small decrease in image quality in spite of its high compression ratio.

MP3: A file format with a sound data compression system, "MPE" is the abbreviation of Motion Picture Experts Group 1 (or MPEG-1) Audio Layer 3. Through the MP3 format, one CD-R or CD-RW can contain about 10 times as much data volume as a regular CD can.

Multichannel: DVD is specified to have all sound tracks constitute one sound field. Multichannel refers to a structure of sound tracks having three or more channels.

Parental control: A function of the DVD to limit playback of the disc by the age of the users according to the limitation level in each country. The limitation varies from disc to disc; when it is activated, playback will be prohibited if the software's level is higher than the user-set level.

Playback control (PBC): Refers to the signal recorded on video CDs or SVCDs for reproduction control. By using screen menus recorded on a Video CD or SVCD that supports PBC, you can enjoy interactive-type software as well as software having a search function.

Region code: A system allowing discs to be played only in preset regions. This unit will only play discs that have compatible region codes. You can find the region code of your unit from the product label. Some discs are compatible with more than one region (or ALL regions).

Sampling Frequency: Frequency of data sampling when analog data is converted to digital data. Sampling frequency numerically represents how many times the original analog signal is sampled per second.

Title: The longest section of a picture or music feature on DVD, music, etc., in video software, or the entire album in audio software. Each title is assigned a title number enabling you to locate the title you want.

VIDEO OUT jack: Jack on the back of the DVD System that sends video to TV.

Meet Philips at the Internet
<http://www.philips.com>

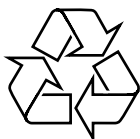

FWD185

