

**PHILIPS**

便携式扬声器

**SB300**

**User manual**



Register your product and get support at  
[www.philips.com/support](http://www.philips.com/support)



# Contents

---

<b>1</b>	<b>Important</b>	<b>1</b>
----------	------------------	----------

---

<b>2</b>	<b>Your portable speaker</b>	<b>2</b>
	Introduction	2
	What's in the box	2
	Overview of the speaker	2

---

<b>3</b>	<b>Get started</b>	<b>4</b>
	Charge the built-in battery	4
	Turn on/off	4

---

<b>4</b>	<b>Play from Bluetooth devices</b>	<b>5</b>
	Connect a device	5
	Play from a Bluetooth-enabled device	5
	Control your phone call	6
	Reconnect a device	6
	Disconnect a device	6
	Connect another device	6
	Clear Bluetooth pairing information	6

---

<b>5</b>	<b>Other features</b>	<b>7</b>
	Play from external devices	7
	Turn the flashing light on/off	7
	Adjust volume	7

---

<b>6</b>	<b>Specifications</b>	<b>8</b>
----------	-----------------------	----------

---

<b>7</b>	<b>Troubleshooting</b>	<b>9</b>
	General	9
	About Bluetooth device	9

---

<b>8</b>	<b>Notice</b>	<b>10</b>
	Compliance	10
	Care of the environment	10
	Trademark notice	11

# 1 Important



## Warning

- Never remove the casing of this speaker.
  - Never place this speaker on other electrical equipment.
  - Keep this speaker away from direct sunlight, naked flames or heat.
- 
- Only use attachments or accessories specified by the manufacturer.
  - The battery shall not be exposed to excessive heat such as sunshine, fire or the like.
  - Do not place any sources of danger on the speaker (e.g. lighted candles).
  - The speaker can meet IPX7 waterproof standard only when the DC IN/AUDIO IN socket cover is covered seamlessly.
  - The speaker supports USB V2.0 or V1.1 only.



## Note

- The type plate is located on the back of the speaker.

## 2 Your portable speaker

Congratulations on your purchase, and welcome to Philips! To fully benefit from the support that Philips offers, register your product at [www.philips.com/welcome](http://www.philips.com/welcome).

### Introduction

With this speaker, you can enjoy audio from Bluetooth-enabled devices or other external devices.

### What's in the box

Check and identify the contents of your package:

- Speaker
- USB cable for charging
- Printed materials



### Overview of the speaker

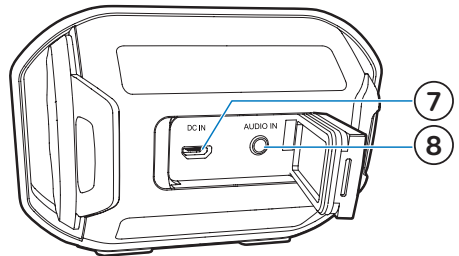
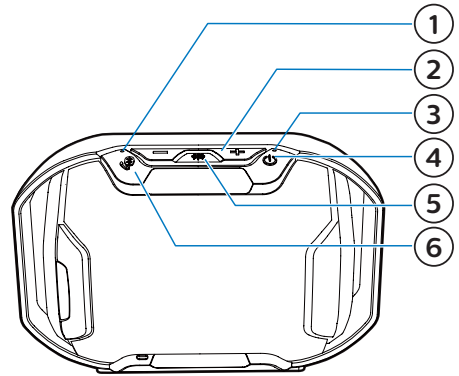

- ① **Bluetooth Indicator**
  - Indicate Bluetooth connection status.
- ② **+/-**
  - Adjust volume.
- ③ **Battery indicator**
  - Indicate battery status.
- ④ **⏻**
  - Turn the speaker on or off.
- ⑤ **\***
  - While playing, turn the flashing light on or off.

⑥ 

- Enter Bluetooth pairing mode.
- After Bluetooth connection, respond to an incoming call.
- Clear Bluetooth pairing information.

⑦ **DC IN**

- Charge the built-in battery.

⑧ **AUDIO IN**

- Connect an external audio device.

# 3 Get started

Always follow the instructions in this chapter in sequence.

## Charge the built-in battery

The speaker is powered by a built-in rechargeable battery.

### Note

- The micro USB socket is for charging only.
- Rechargeable battery has a limited number of charge cycles. Battery life and number of charge cycles vary by use and settings.

- 1 Flip open the cover on the back of the speaker.
- 2 Connect the speaker to AC power by using the adaptor (not supplied).

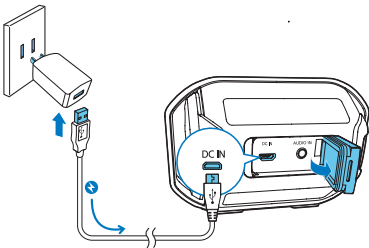

The battery LED indicator indicates the battery status.

Battery Status	Battery Indicator
Under charging	Solid red
Low battery	Flashing red for 10 minutes, then no light
Fully charged	Off

## Turn on/off

- To turn on the speaker, press and hold  $\text{⏻}$  until the blue LED indicator flashes.
- To turn off the speaker, press and hold  $\text{⏻}$  until the blue LED indicator turns off.

### Note

- The speaker switches to standby mode automatically when being idle for 15 minutes.

# 4 Play from Bluetooth devices

With this speaker, you can listen to audio from Bluetooth-enabled devices.

## Connect a device

### Note

- Any obstacle between this speaker and a Bluetooth device can reduce the operational range.
- Keep away from any other electronic device that may cause interference.
- The operational range between this speaker and a Bluetooth device is approximately 10 meters (30 feet).

- 1 Make sure that the speaker is in Bluetooth pairing mode.
  - For first-time use, the speaker enters pairing mode automatically.
  - If the speaker has been paired with other device before, press and hold  on the speaker for three seconds to enter pairing mode.

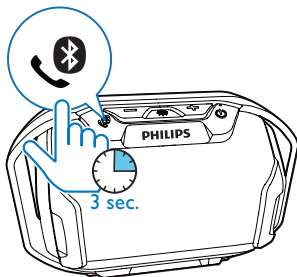

- ↳ The Bluetooth indicator flashes blue quickly.

- 2 On your Bluetooth device, enable Bluetooth and search for Bluetooth devices that can be paired (refer to the user manual of the device).
- 3 Select **[Philips SB300]** displayed on your device for pairing and connection. If necessary, input “0000” as the pairing password.

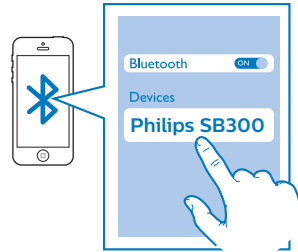

- ↳ After successful pairing and connection, the speaker beeps twice, and the Bluetooth LED indicator turns solid blue.

### Bluetooth LED indicator (blue):

Bluetooth Indicator	Bluetooth Connection Status
Flashing quickly (2Hz)	Pairing
Flashing slowly (1Hz)	Connecting
Solid blue	Connected

## Play from a Bluetooth-enabled device

- After successful Bluetooth connection, play audio on your Bluetooth device.
- ↳ Music streams from your Bluetooth device to the speaker.



---

## Control your phone call

After Bluetooth connection, you can control an incoming call with this speaker.

Button	Function
	Press to answer an incoming call.
	Press and hold for three seconds to reject an incoming call.
	During a call, press to end the current call.
	During a call, press and hold for three seconds to transfer the call between your mobile device and the speaker.

### Note

- Music play pauses when there is an incoming call, and resumes when your phone call ends.

---

## Reconnect a device

- When you turn on the speaker, it tries to reconnect the last connected device automatically;
- If not successful, select **[Philips SB300]** on your Bluetooth menu to start reconnection.

---

## Disconnect a device

- Press and hold  for three seconds;
- Turn off the speaker;
- Disable Bluetooth on your device; or
- Move the device beyond the communication range.

---

## Connect another device

- 1 Press and hold  for three seconds to disconnect the currently connected device.
  - ↳ The speaker enters Bluetooth pairing mode.
- 2 Connect another Bluetooth device.

---

## Clear Bluetooth pairing information

Press and hold  for ten seconds to clear Bluetooth pairing information.

# 5 Other features

## Play from external devices

With this speaker, you can also listen to an external audio device such as an MP3 player.

### Note

- Make sure that music playback through Bluetooth is stopped.

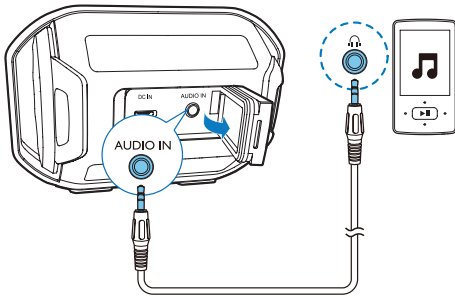

- 1 Flip open the cover on the back of the speaker.
- 2 Connect an audio input cable (not supplied) with a 3.5 mm connector on both ends to
  - the **AUDIO IN** socket on this speaker, and
  - the headphone socket on the external device.
- 3 Play audio on the external device (refer to its user manual).
  - ↳ The speaker switches to the **AUDIO IN** mode.

### Tip

- When you start music streaming from a connected Bluetooth device, the speaker switches to the Bluetooth source automatically.

## Turn the flashing light on/off

While playing, press **\*** to turn the flashing light on or off.

- ↳ When the light is turned on, its color changes randomly.

## Adjust volume

During play, press **+/-** repeatedly to increase or decrease volume.

### Tip

- You can press and hold **+/-** to increase or decrease volume continuously.
- When the volume reaches the maximum, the speaker beeps twice.

# 6 Specifications

## Note

- Product information is subject to change without prior notice.

Product Dimensions (W x H x D)	117 x 77 x 74 mm
Product Weight	0.23 kg

Rated Output Power (Amplifier)	4W RMS $\leq$ 1% THD
--------------------------------	----------------------

Acoustic Frequency Response	110–16000 Hz
-----------------------------	--------------

Speaker Driver	1.5" full range, 4 $\Omega$
----------------	-----------------------------

Bass Enhancement	2 x passive radiator
------------------	----------------------

Bluetooth Version	V4.0
-------------------	------

Bluetooth Supported Profiles	HFP V1.6, A2DP V1.2, AVRCP V1.4
------------------------------	---------------------------------

Bluetooth Frequency Band / Output Power	2.400GHz ~ 2.483GHz ISM Band / $\leq$ 4dBm (Class 2)
---	--

AUX Input Level	500mV $\pm$ 100mV
-----------------	-------------------

Water Resistance	IPX7
------------------	------

Battery	Built-in Li-ion rechargeable battery (3.7V, 800 mAh)
---------	--

Play Time in Battery Mode	Approx. 8 hours
---------------------------	-----------------

Charging Time	Approx. 3 hours
---------------	-----------------

USB Charging	5V, 500mA / Type-A socket
--------------	---------------------------

# 7 Troubleshooting



## Warning

- Never remove the casing of this device.

To keep the warranty valid, never try to repair the system yourself. If you encounter problems when using this device, check the following points before requesting service. If the problem remains unsolved, go to the Philips Web page ([www.philips.com/support](http://www.philips.com/support)). When you contact Philips, make sure that the device is nearby and the model number and serial number are available.

---

## General

### No power

- Recharge your speaker.

### No sound

- Adjust volume on the connected device.
- In AUDIO IN mode, make sure that music playback through Bluetooth is stopped.
- Make sure that your Bluetooth device is within the effective operational range.

### Fail to turn on the speaker.

- After the speaker is turned off, wait for over 30 seconds and then turn it on.

---

## About Bluetooth device

### The audio quality is poor after connection with a Bluetooth-enabled device.

- The Bluetooth reception is poor. Move the device closer to this product or remove any obstacle between them.

### Cannot connect with the device.

- The Bluetooth function of the device is not enabled. Refer to the user manual of the device for how to enable the function.
- This product is already connected with another Bluetooth-enabled device. Disconnect that device and then try again.
- This product is not in pairing mode. Press and hold  for three seconds to enter pairing mode, and then try again.

### The paired device connects and disconnects constantly.

- The Bluetooth reception is poor. Move the device closer to this product or remove any obstacle between them.
- For some devices, Bluetooth connection may be deactivated automatically as a power-saving feature. This does not indicate any malfunction of this product.

# 8 Notice

Any changes or modifications made to this device that are not expressly approved by Gibson Innovations may void the user's authority to operate the equipment.

---

## Care of the environment

### Disposal of your old product



Your product is designed and manufactured with high quality materials and components, which can be recycled and reused.

Do not throw away the product with the normal household waste at the end of its life, but hand it in at an official collection point or recycling. By doing this, you help to preserve the environment.



### Caution

- Removal of the built-in battery invalidates the warranty and may destroy the product.

Always bring your product to a professional to remove the built-in battery.

### Environmental information

All unnecessary packaging has been omitted. We have tried to make the packaging easy to separate into three materials: cardboard (box), polystyrene foam (buffer) and polyethylene (bags, protective foam sheet.)

Your system consists of materials which can be recycled and reused if disassembled by a specialized company. Please observe the local regulations regarding the disposal of packaging materials, exhausted batteries and old equipment.

---

## Trademark notice



The Bluetooth® word mark and logos are registered trademarks owned by Bluetooth SIG, Inc. and any use of such marks by Gibson Innovations Limited is under license. Other trademarks and trade names are those of their respective owners.



2016 © Gibson Innovations Limited. All rights reserved.

This product has been manufactured by, and is sold under the responsibility of WOOX Innovations (Shanghai) Commercial Company Ltd., and WOOX Innovations (Shanghai) Commercial Company Ltd., is the warrantor in relation to this product.

Philips and the Philips Shield Emblem are registered trademarks of Koninklijke Philips N.V. and are used under license.

SB300\_93\_UM\_V1.0