

PHILIPS

Soundbar

5000 Series

TAB5706



www.philips.com/welcome





EN Before using your Product, read all accompanying safety information

JA 本製品を使用する前に、安全上のご注意事項をすべてお読みください。

KR 제품을 사용하기 전에 동봉된 모든 안전 정보를 읽어보십시오

TW 使用產品前，請閱讀隨附的所有安全資訊

ID Sebelum menggunakan produk, baca semua informasi petunjuk keamanan

VT Trước khi sử dụng Sản phẩm của bạn, hãy đọc tất cả thông tin an toàn kèm theo

TH ก่อนใช้งานผลิตภัณฑ์ โปรดอ่านข้อมูลด้านความปลอดภัยทั้งหมดที่แนบมาด้วย

AR اقرأ معلومات السلامة المرفقة بالكامل قبل استخدام المنتج

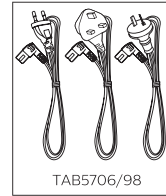
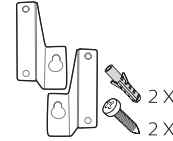
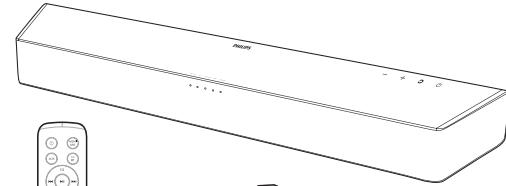

TAB5706/98

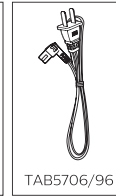

TAB5706/96

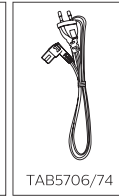

TAB5706/74

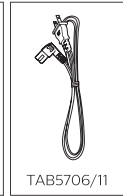

TAB5706/11



* The attached items and images may vary by region.

* Power cord quantity and plug type vary by regions.

* 付属の電源ケーブルは本製品専用になります。
他の製品にはご使用できません。



EN Position the SoundBar / Wall mount the SoundBar (optional)

JA サウンドバーをオーディオラックの上などに設置します。(日本では壁取り付けは推奨しておりません。棚置き設置でご使用ください。)

KR 사운드바 배치/사운드바 벽면 장착(음선)

TW 放置聲霸/壁掛式安裝聲霸 (可選)

ID Posisikan SoundBar/Pasang SoundBar di tembok (opsional)

VT Xác định vị trí SoundBar / Tường gắn SoundBar (tùy chọn)

TH การจัดตำแหน่งซาวด์บาร์/ติดตั้งซาวด์บาร์บนกำแพง (ไม่จำเป็น)

AR موضع العارضة الصوتية/تركيب العارضة الصوتية على الحائط (اختياري)

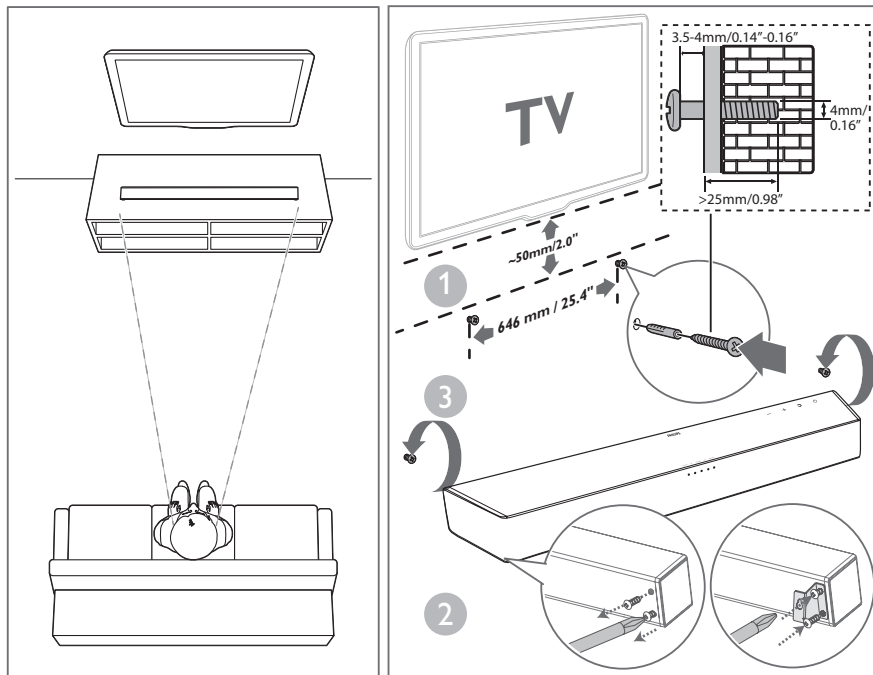

Suggested wall mounting height

You are suggested to install the TV first before wall mounting the soundbar. With a TV preinstalled, wall mount the soundbar 50mm/2.0" in distance from the bottom of the TV.

If you wall mount the soundbar first, drill 2 parallel holes (Ø 3-8 mm each according to wall type) in the wall. The distance between the holes should be 646mm/25.4".

2

EN Connect the SoundBar

JA テレビにサウンドバーを接続します。

KR 사운드바 연결

TW 連接聲霸

ID Hubungkan SoundBar

VT Kết nối SoundBar

TH การเชื่อมต่อซาวด์บาร์

توصيل العارضة الصوتية **AR**

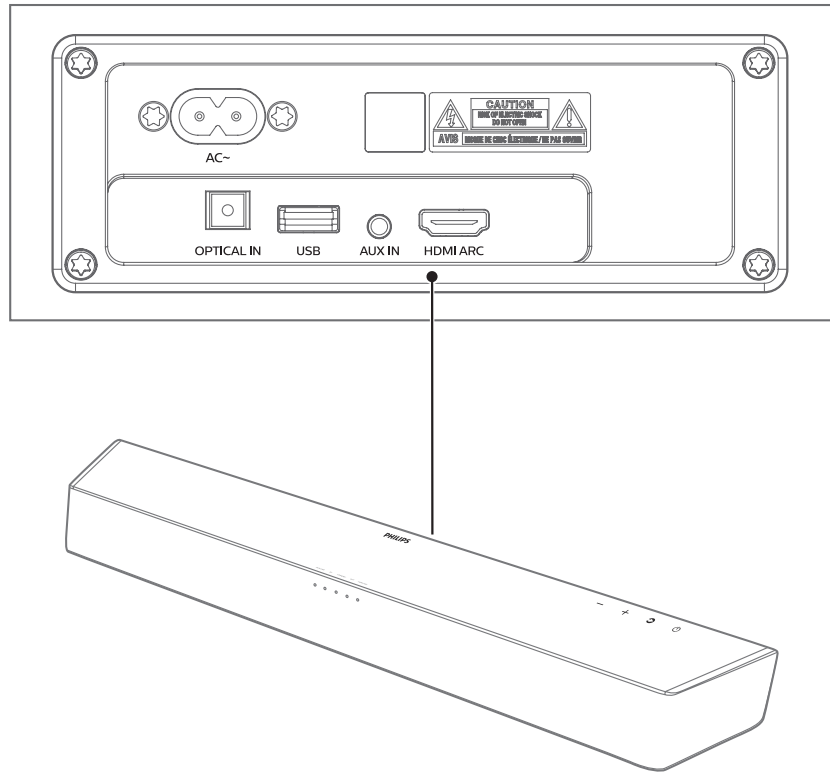

3

EN Hear audio from TV in one of the following ways

JA HDMI、光デジタル、アナログケーブルのいずれかの方法で、接続してください。

KR 다음 방법 중 하나로 TV 오디오 듣기

TW 透過以下方式之一收聽電視的音訊

ID Nikmati audio TV dengan salah satu cara berikut

VT Nghe âm thanh từ TV theo một trong các cách sau đây

TH ได้ยินเสียงจากทีวีในแบบใดแบบหนึ่งดังต่อไปนี้

وصول الصوت من التلفاز بإحدى الطرق التالية **AR**

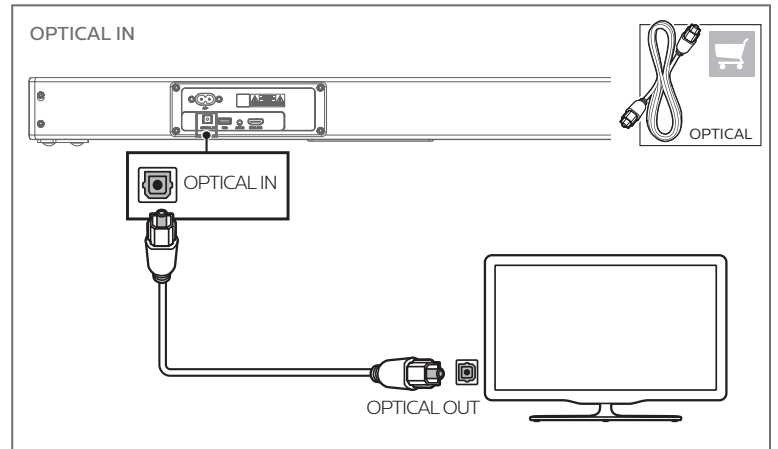
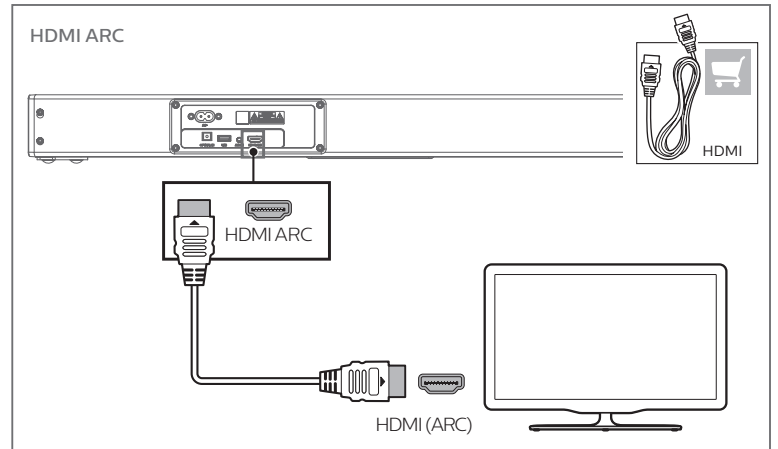

AUX IN

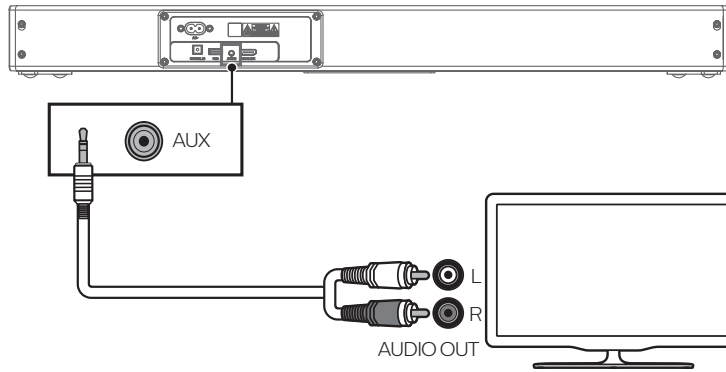
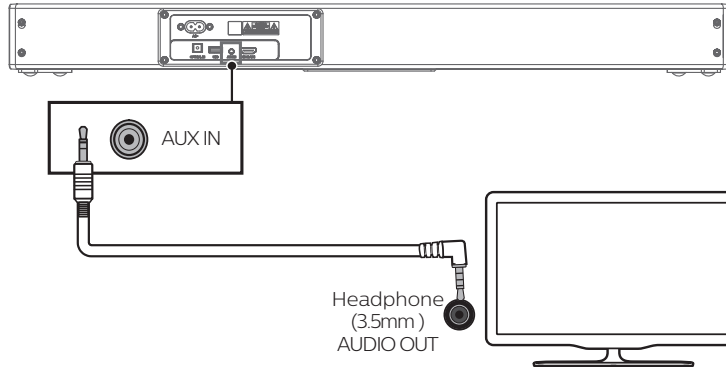

4

EN Switch on the SoundBar

JA 電源ケーブルを壁のコンセントに接続します。リモコンに電池を入れます。電源をオンにします。

KR 사운드바 켜기

TW 開啟聲霸

ID Nyalakan SoundBar

VT Bật SoundBar

TH เปิดซาวด์บาร์

AR ابدأ تشغيل العارضة الصوتية

1

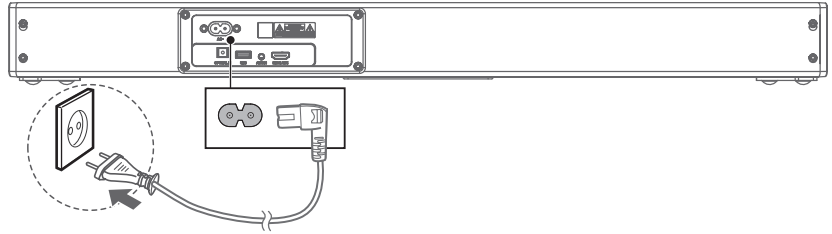

2

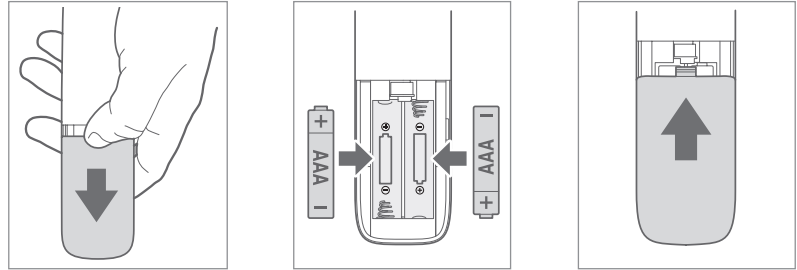

3

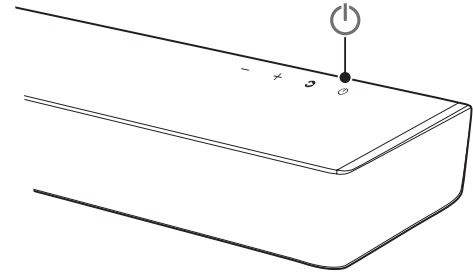
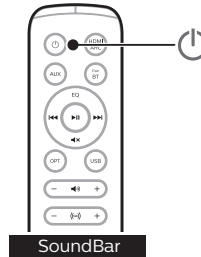

5

EN Select the correct audio source

JA リモコンでオーディオソースを選択します。HDMI接続の場合はHDMIボタンを、光デジタル接続の場合はOPTICALボタンを、アナログ接続の場合はAUXを押してください。

KR 올바른 오디오 소스 선택

TW 選擇正確的音訊來源

ID Pilih sumber audio yang benar

VT Chọn nguồn âm thanh đúng

TH เลือกแหล่งที่มาของเสียงที่ถูกต้อง

حدد مصدر الصوت الصحيح **AR**

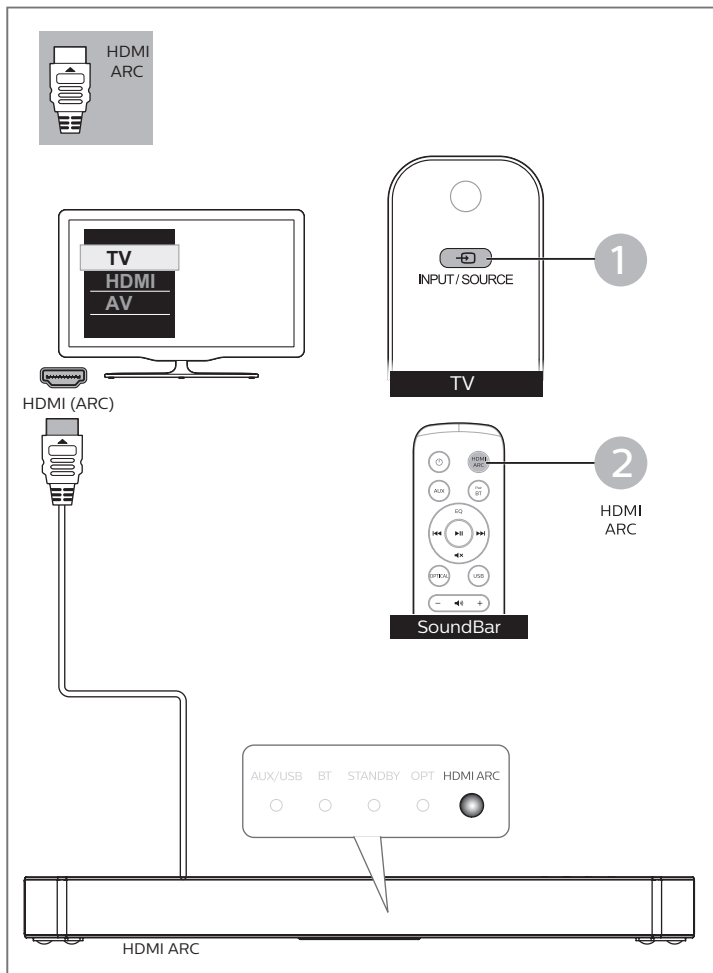

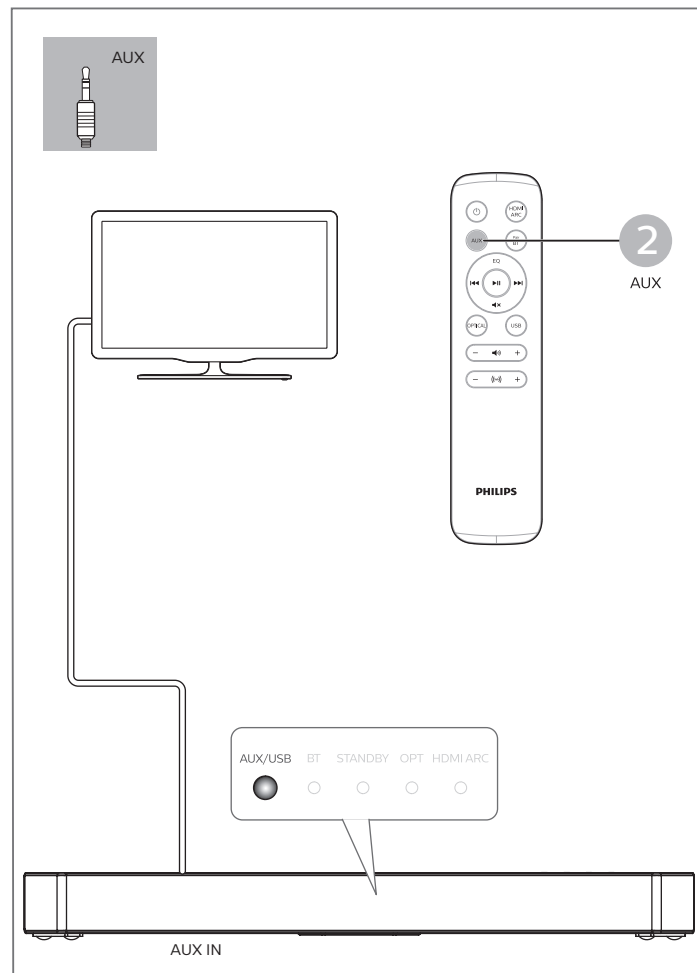
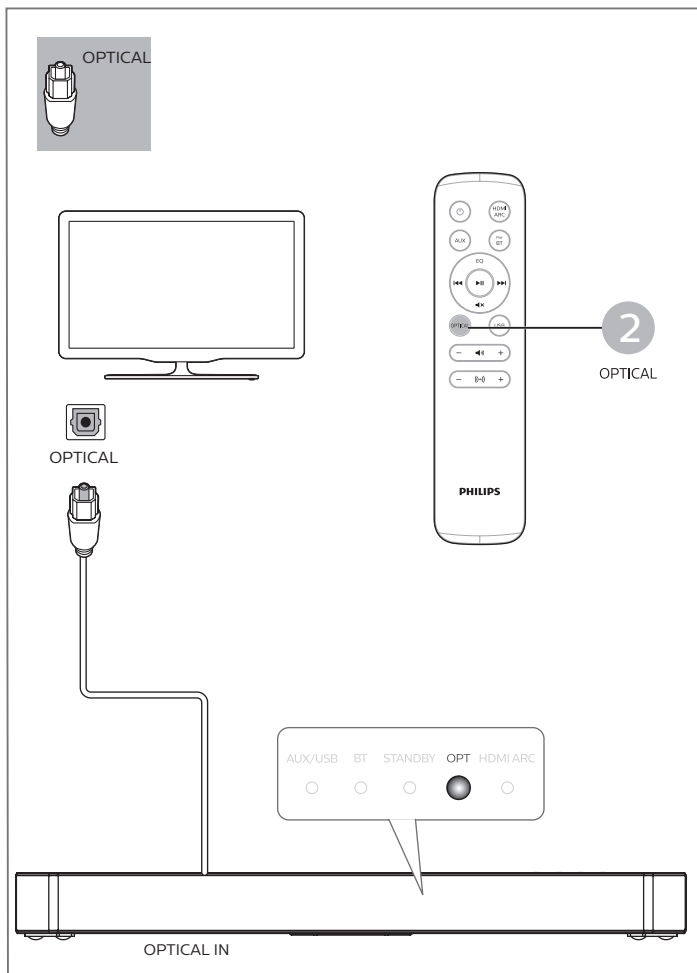

6

EN Play other devices

JA テレビ以外の機器を接続し、再生することも可能です。

KR 기타 장치 재생

TW 播放其他裝置

ID Putar perangkat lainnya

VT Phát các thiết bị khác

TH เล่นจากอุปกรณ์อื่น

ابدأ تشغيل الأجهزة الأخرى **AR**

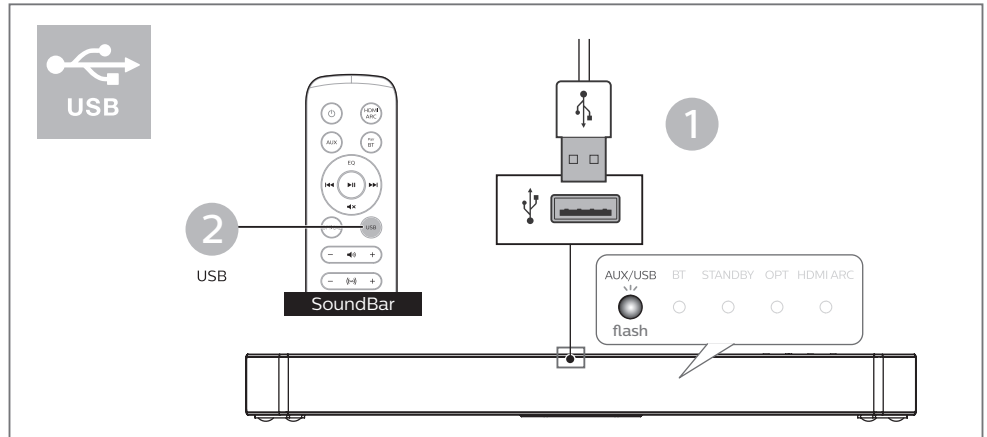
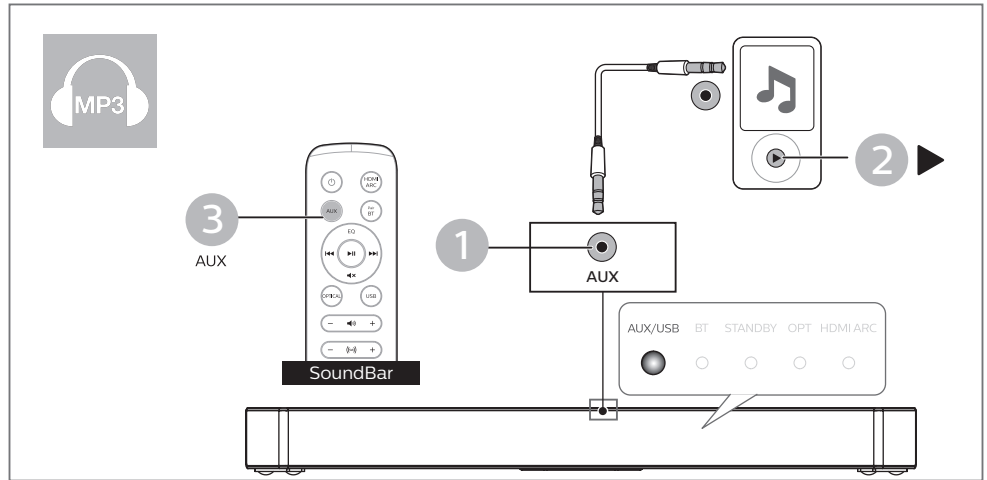

7

EN Play audio through Bluetooth

JA Bluetooth 機器の接続が可能です。リモコンのBTボタンを押し、デバイス側のBluetoothをオンにしてください。ペアリングが完了したら、音楽をお楽しみください

KR Bluetooth를 통해 오디오 재생

TW 透過藍牙播放音訊

ID Putar audio melalui Bluetooth

VT Phát âm thanh qua Bluetooth

TH เล่นเสียงผ่านระบบ Bluetooth

ابدأ تشغيل الصوت عبر البلوتوث **AR**



Bluetooth
Frequency band / Output power
2400-2483.5 MHz / ≤ 5 dBm

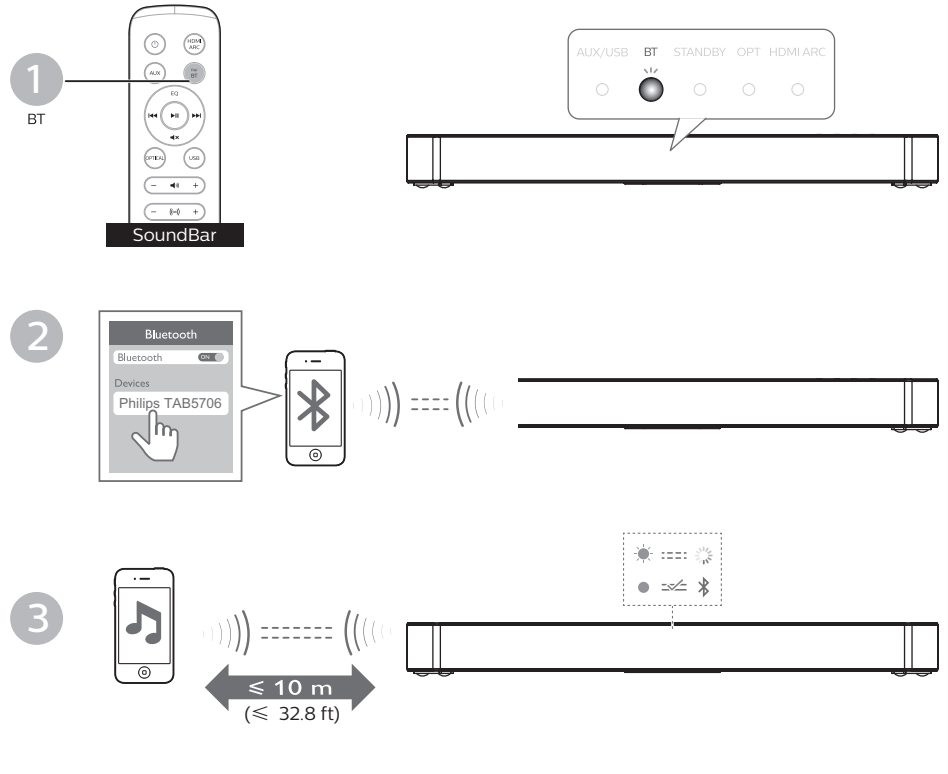



EN For more information about using this product, visit www.philips.com/support

JA 本製品の使用方法の詳細については、www.philips.com/supportにアクセスしてください。

KR 제품 사용에 대한 자세한 내용은 사이트를 방문하십시오.
www.philips.com/support

TW 欲知有關使用本產品的更多資訊，請瀏覽www.philips.com/support

ID Untuk informasi lebih lanjut tentang produk ini, kunjungi www.philips.com/support

VT Để biết thêm thông tin về cách sử dụng sản phẩm này, hãy truy cập www.philips.com/support

TH สำหรับข้อมูลเพิ่มเติมเกี่ยวกับการใช้งานผลิตภัณฑ์ โปรดไปที่ www.philips.com/support

AR للحصول على مزيد من المعلومات عن استخدام هذا المنتج، الرجاء زيارة الرابط التالي www.philips.com/support



Manufactured under license from Dolby Laboratories. Dolby, Dolby Audio, and the double-D symbol are trademarks of Dolby Laboratories Licensing Corporation.

The Adopted Trademarks HDMI, HDMI High-Definition Multimedia Interface, and the HDMI Logo are trademarks or registered trademarks of HDMI Licensing Administrator, Inc. in the United States and other countries.

The Bluetooth® word mark and logos are registered trademarks owned by Bluetooth SIG, Inc. and any use of such marks by MMD Hong Kong Holding Limited is under license. Other trademarks and trade names are those of their respective owners.

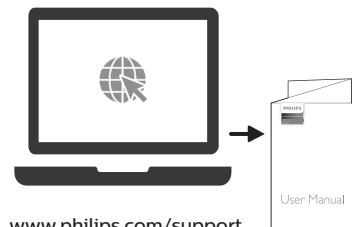

www.philips.com/support



Specifications are subject to change without notice. Please visit www.philips.com/support for the latest updates and documents.

Philips and the Philips Shield Emblem are registered trademarks of Koninklijke Philips N.V. and are used under license.

This product has been manufactured by and is sold under the responsibility of MMD Hong Kong Holding Limited, or one of its affiliates, and MMD Hong Kong Holding Limited, is the warrantor in relation to this product.

