

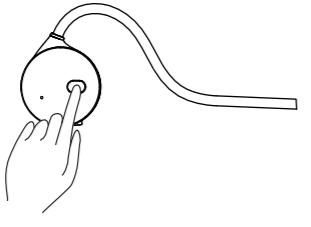





**6** 

**L**





 /  =  x1 |  =  : 02"

**7** 

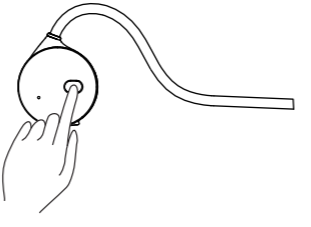
**L**



 =  : 02"

**English:**

**Notes of compliance:** The device complies with the FCC rules, Part 15. Operation is subject to the following two conditions:

1. This device may not cause harmful interference, and
2. This device must accept any interference received, including interference that may cause undesired operation.

**FCC rules:** This equipment has been tested and found to comply with the limits for a Class B digital device, pursuant to part 15 of the FCC Rules. These limits are designed to provide reasonable protection against harmful interference in a residential installation. This equipment generates, uses and can radiate radio frequency energy and, if not installed and used in accordance with the instruction manual, may cause harmful interference to radio communications. However, there is no guarantee that interference will not occur in a particular installation. If this equipment does cause harmful interference to radio or television reception, which can be determined by turning the equipment off and on, the user is encouraged to try to correct the interference by one or more of the following measures:

- Reorient or relocate the receiving antenna.
- Increase the separation between equipment and receiver.
- Connect the equipment into an outlet on a circuit different from that to which the receiver is connected.
- Consult the dealer or an experienced radio/TV technician for help.

**FCC Radiation Exposure Statement:** This equipment complies with FCC radiation exposure limits set forth for an uncontrolled environment. This transmitter must not be co-located or operating in conjunction with any other antenna or transmitter. Caution: The user is cautioned that changes or modifications not expressly approved by the party responsible for compliance could void the user's authority to operate the equipment.

**Canada:** This device contains licence-exempt transmitter(s) (receiver(s)) that comply with Innovation, Science and Economic Development Canada's licence-exempt RSS(s). Operation is subject to the following two conditions: (1) This device may not cause harmful interference, and (2) This device must accept any interference received, including interference that may cause undesired operation of the device. CANICES-003(B)/NMB-003(B)

**IC Radiation Exposure Statement:** This equipment complies with Canada radiation exposure limits set forth for uncontrolled environments. This transmitter must not be co-located or operating in conjunction with any other antenna or transmitter.

**Français:**

**Avis de conformité:** Cet appareil satisfait aux règlements de la FCC partie 15 du Code of Federal Regulations. Son fonctionnement est assujéti aux deux conditions suivantes:

1. Cet appareil ne doit pas causer d'interférence préjudiciable et
2. L'appareil doit accepter toute interférence reçue, y compris les interférences qui peuvent causer un fonctionnement non désiré.

**Règlement de la FCC:** Cet équipement a été testé et jugé compatible avec les limites s'appliquant aux appareils numériques de la classe B, conformément à l'article 15 du règlement de la FCC. Ces limites ont été définies pour fournir une protection raisonnable contre les interférences nuisibles dans le cadre d'une installation résidentielle. Cet équipement génère, utilise et peut émettre de l'énergie radiofréquence et, s'il n'est pas installé ni utilisé conformément aux instructions, peut causer des interférences gênantes pour les communications radio. Rien ne garantit toutefois que des interférences ne surviendront pas dans une installation particulière. Si cet équipement cause des interférences nuisibles pour la réception de la radio ou de la télévision, ce qui peut être déterminé en mettant l'équipement hors tension puis sous tension, l'utilisateur devra essayer de corriger ces interférences en effectuant une ou plusieurs des opérations suivantes:

- Déplacez l'antenne de réception.
- Augmentez la distance entre l'équipement et le récepteur.
- Branchez l'équipement à une prise d'un circuit autre que celui sur lequel le récepteur est branché.
- Consultez le détaillant ou un technicien de radio-télévision expérimenté.

**Canada:** L'émetteur/récepteur exempt de licence contenu dans le présent appareil est conforme aux CNR d'Innovation, Sciences et Développement économique Canada applicables aux appareils radio exempts de licence. L'exploitation est autorisée aux deux conditions suivantes:

1. L'appareil ne doit pas produire de brouillage;
2. L'appareil doit accepter tout brouillage radioélectrique subi, même si le brouillage est susceptible d'en compromettre le fonctionnement. CANICES-003(B)/NMB-003(B)

**Déclaration FCC sur l'exposition aux radiations:** Cet équipement est conforme aux limites d'exposition aux radiations définies par le Canada pour des environnements non contrôlés. Cet émetteur ne doit pas être installé au même endroit ni utilisé avec une autre antenne ou un autre émetteur.

**免責:** お客様がご購入された製品について、当社に故障または重大な過失がある場合を除き、お客様責任は購入者責任に限定されます。弊社の保証は本製品の機能に関する保証のみに限ります。保証規定・保証期間中に正常な使用状況のもとで故障した場合は、保証期間内でも有償修理いたします。万一故障した場合は、以下の注意事項を必ずお読みください。

1. 自転車、自動車、オートバイなどの運転中に、ヘッドセットを使用しないでください。交通事故の原因になります。
2. 読み切り、車の通る道、工事現場など周囲の音が聞こえない危険な場所ヘッドセットを使用しないでください。事故や怪我の原因となります。
3. 接続されたボタンの機能の音量を上げすぎないようにご注意ください。耳を刺すような大きな音響で長時間つけてると、聴力に悪い影響を与えることがあります。
4. 高温やほりの多い場所、直射日光の当たる場所、水のかかる場所には着かないでください。故障の原因になります。
5. 故障したときは使用しないでください。
6. 本製品は、日本国内でのみ有効です。

**免責:** お客様が購入された製品について、弊社に故障または重大な過失がある場合を除き、お客様責任は購入者責任に限定されます。弊社の保証は本製品の機能に関する保証のみに限ります。保証規定・保証期間中に正常な使用状況のもとで故障した場合は、保証期間内でも有償修理いたします。万一故障した場合は、以下の注意事項を必ずお読みください。

1. 本車との衝突がない場合。
2. お買い上げ販売店名の記載及び捺印、お買い上げ年月日がない場合。
3. ご使用上の誤り、不適な修理や改造による故障及び損傷。
4. 火災、地震、風水害、雷、その他の天災地変、盗害、落害、紛失、盗難、悪意、故意な使用等による故障及び損傷。
5. 不具合の原因が本製品以外(外部要因)による場合。
6. 一部部品以外の(例:本製品付属)での使用による故障及び損傷。
7. 消耗部品の故障(例:音圧低下による故障)。
8. お買い上げ後の輸送、移動、落下及び移りかたによる故障及び損傷。
9. その他弊社の判断に基づき、無償保証が認められない場合。

本製品は、日本国内においてのみ有効です。  
(This warranty is valid only in Japan.)

**ADVERTENCIA:** Cuidados con a utilização e descarte de pilhas e baterias. Não descarte as pilhas e baterias juntamente ao lixo doméstico. O descarte inadequado de pilhas e baterias pode representar riscos ao meio ambiente e à saúde humana. Para contribuir com a qualidade ambiental e com sua saúde, a Philips recollecta pilhas e baterias comercializadas ou fornecidas com seus produtos após seu fim de vida, que serão encaminhadas à destinação ambientalmente correta. A Philips dispõe de pontos de coleta em Assistência Técnica.

\* Full user manual in all languages available on: | Manuel d'utilisation complet dans toutes les langues disponibles sur: | Manual completo de usuario disponible en todos los idiomas en: | Die vollständige Bedienungsanleitung ist in allen Sprachen verfügbar unter: | Manuale dell'utente completo in tutte le lingue disponibile su: | Manual do utilizador completo em todos os idiomas, disponível em: | Volledige gebruikershandleiding in alle talen beschikbaar op: | Полное руководство пользователя на всех языках доступно по ссылке: | Батри́хы, титиде́рлер: толық нұсқалықты мына жерден алуға болады | 金言語での完全版取扱説明書は以下で利用可能です | (1) 電話: 400-00-1000 (2) 検索: 400-00-1000 (3) 検索: 400-00-1000 (4) 検索: 400-00-1000

[www.philips.com/support](http://www.philips.com/support)

**PHILIPS**

**Headphones**

**1000 Series**

TAA1609







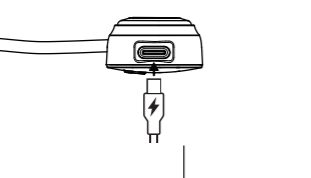

[www.philips.com/welcome](http://www.philips.com/welcome)

**1** 

**L**







 =   = 

**2** 

**L**



1.  =  =  ...  ...

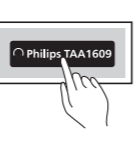

 : 04"

2.  

**3** 

**L**





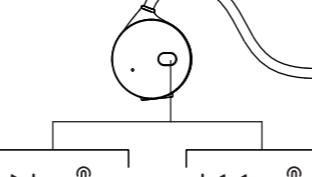

 =  x1

**4** 

**L**





 =  x2

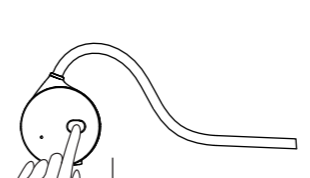

 =  x3

**5** 

**L**



 =  : 02"

 =  : 04"

**PHILIPS**

**Welcome to Philips!**

For an optimal experience register your product at:  
Para especificações e dados de garantia do produto no Brasil, acesse o website abaixo:  
Pour une expérience optimale, enregistrez votre produit à l'adresse suivante:  
[www.philips.com/welcome](http://www.philips.com/welcome)

Philips and the Philips Shield Emblem are registered trademarks of Koninklijke Philips NV, and are used under license. This product has been manufactured by and is sold under the responsibility of MMD Hong Kong Holding Limited or one of its affiliates, and MMD Hong Kong Holding Limited is the warrantor in relation to this product.

Authorised Representative: UKCA Experts Ltd, Dept 302, 43 Ovston Road Carcroft Doncaster, DN6 8DA United Kingdom

Este equipamento opera em caráter secundário, isto é, não tem direito à proteção contra interferência prejudicial, mesmo de estações do mesmo tipo, e não pode causar interferência sistemas operando em caráter primário.

LEA CUIDADOSAMENTE ESTE INSTRUCTIVO ANTES DE USAR SU APARTO