

Register your product and get support at
www.philips.com/welcome

DCM263



EN User manual

PHILIPS

Contents

1 Important	4
Safety	4
Notice	6
2 Your DVD Micro Theater	7
Introduction	7
What's in the box	7
Overview of the main unit	8
Overview of the subwoofer	10
Overview of the remote control	10
3 Connect	12
Place the unit	12
Before you connect	12
Connect TV	12
Connect Subwoofer	13
Connect power	14
4 Get started	15
Prepare the remote control	15
Set clock	15
Turn on	15
Find the correct viewing channel	16
Select the correct TV system	16
Change system menu language	16
Turn on Progressive Scan	16
5 Play	18
Play discs	18
Play from USB	18
Play DivX video	19
Play MP3/WMA/picture files	19
Play control	19
Play options	20
Picture view options	21
6 Adjust settings	22
General setup	22
Audio setup	22
Video setup	23
Preferences	24
7 Tune to FM radio stations	27
Plug & Play	27
Program radio stations automatically	27
Program radio stations manually	27
Tune to a preset radio station	28
8 Adjust volume level and sound effect	29
Adjust volume level	29
Select a sound effect	29
Mute sound	30
Listen through headphone	30
9 Other features	31
Adjust brightness of display panel	31
Set the alarm timer	31
Set the sleep timer	31
Connect other devices	31
10 Product information	32
Specifications	32
Supported disc formats	33
USB playability information	33
11 Troubleshooting	34
12 Appendix	36
Mount to a wall	36

1 Important

Safety

Important Safety Instructions

- ① Read these instructions.
- ② Keep these instructions.
- ③ Heed all warnings.
- ④ Follow all instructions.
- ⑤ Do not use this apparatus near water.
- ⑥ Clean only with dry cloth.
- ⑦ Do not block any ventilation openings. Install in accordance with the manufacturer's instructions.
- ⑧ Do not install near any heat sources such as radiators, heat registers, stoves, or other apparatus (including amplifiers) that produce heat.
- ⑨ Protect the power cord from being walked on or pinched, particularly at plugs, convenience receptacles, and the point where they exit from the apparatus.
- ⑩ Only use attachments/accessories specified by the manufacturer.
- ⑪ Use only with the cart, stand, tripod, bracket, or table specified by the manufacturer or sold with the apparatus. When a cart is used, use caution when moving the cart/apparatus combination to avoid injury from tip-over.
- ⑫ Unplug this apparatus during lightning storms or when unused for long periods of time.
- ⑬ Refer all servicing to qualified service personnel. Servicing is required when the apparatus has been damaged in any way, such as power-supply cord or plug is damaged, liquid has been spilled or objects have fallen into the apparatus, the apparatus has been exposed to rain or moisture, does not operate normally, or has been dropped.
- ⑭ Battery usage **CAUTION** – To prevent battery leakage which may result in bodily injury, property damage, or damage to the unit:
 - Install all batteries correctly, + and - as marked on the unit.
 - Do not mix batteries (old and new or carbon and alkaline, etc.).
 - Remove batteries when the unit is not used for a long time.
 - The batteries shall not be exposed to excessive heat such as sunshine, fire or the like.
- ⑮ Apparatus shall not be exposed to dripping or splashing.
- ⑯ Do not place any sources of danger on the apparatus (e.g. liquid filled objects, lighted candles).
- ⑰ This product may contain lead and mercury. Disposal of these materials may be regulated due to environmental considerations. For disposal or recycling information, please contact your local authorities or the Electronic Industries Alliance: www.eiae.org.
- ⑱ Where the MAINS plug or an appliance coupler is used as the disconnect device, the disconnect device shall remain readily operable.



**Caution**

- Use of controls or adjustments or performance of procedures other than herein may result in hazardous radiation exposure or other unsafe operation.

Know these safety symbols

This 'bolt of lightning' indicates uninsulated material within your unit may cause an electrical shock. For the safety of everyone in your household, please do not remove product covering.

The 'exclamation mark' calls attention to features for which you should read the enclosed literature closely to prevent operating and maintenance problems. **WARNING:** To reduce the risk of fire or electric shock, this apparatus should not be exposed to rain or moisture and objects filled with liquids, such as vases, should not be placed on this apparatus.

CAUTION: To prevent electric shock, fully insert the plug. (For regions with polarized plugs: To prevent electric shock, match wide blade to wide slot.)

**Warning**

- Never remove the casing of this unit.
- Never lubricate any part of this unit.
- Place this unit on a flat, hard and stable surface.
- Never place this unit on other electrical equipment.
- Only use this unit indoors. Keep this unit away from water, moisture and liquid-filled objects.
- Keep this unit away from direct sunlight, naked flames or heat.
- Never look into the laser beam inside the unit.

Wall mounting of the unit should only be performed by qualified personnel. The unit

must only be mounted on an appropriate wall bracket and on a wall that can safely hold the weight of the unit. Improper wall mounting can result in severe injury or damage. Do not attempt to wall mount the unit yourself.

Hearing safety**Listen at a moderate volume.**

- Using headphones at a high volume can impair your hearing. This product can produce sounds in decibel ranges that may cause hearing loss for a normal person, even for exposure less than a minute. The higher decibel ranges are offered for those that may have already experienced some hearing loss.
- Sound can be deceiving. Over time your hearing 'comfort level' adapts to higher volumes of sound. So after prolonged listening, what sounds 'normal' can actually be loud and harmful to your hearing. To guard against this, set your volume to a safe level before your hearing adapts and leave it there.

To establish a safe volume level:

- Set your volume control at a low setting.
- Slowly increase the sound until you can hear it comfortably and clearly, without distortion.

Listen for reasonable periods of time:

- Prolonged exposure to sound, even at normally 'safe' levels, can also cause hearing loss.
- Be sure to use your equipment reasonably and take appropriate breaks.

Be sure to observe the following guidelines when using your headphones.

- Listen at reasonable volumes for reasonable periods of time.
- Be careful not to adjust the volume as your hearing adapts.
- Do not turn up the volume so high that you can't hear what's around you.
- You should use caution or temporarily discontinue use in potentially hazardous situations. Do not use headphones while operating a motorized vehicle, cycling, skateboarding, etc.; it may create a traffic hazard and is illegal in many areas.

Notice

Any changes or modifications made to this device that are not expressly approved by Philips Consumer Lifestyle may void the user's authority to operate the equipment.

Environmental information

All unnecessary packaging has been omitted. We have tried to make the packaging easy to separate into three materials: cardboard (box), polystyrene foam (buffer) and polyethylene (bags, protective foam sheet.) Your system consists of materials which can be recycled and reused if disassembled by a specialized company. Please observe the local regulations regarding the disposal of packaging materials, exhausted batteries and old equipment.



**Be responsible
Respect copyrights**

The making of unauthorized copies of copy-protected material, including computer programs, files, broadcasts and sound recordings, may be an infringement of copyrights and constitute a criminal offence. This equipment should not be used for such purposes.



HDMI, and HDMI logo and High-Definition Multimedia Interface are trademarks or registered trademarks of HDMI licensing LLC.



'DVD Video' is a trademark of DVD Format/Logo Licensing Corporation.



Manufactured under license from Dolby Laboratories.

Dolby, Pro Logic, and the double-D symbol are trademarks of Dolby Laboratories.



ABOUT DIVX VIDEO: DivX® is a digital video format created by DivX, Inc. This is an official DivX Certified device that plays DivX video. Visit www.divx.com for more information and software tools to convert your files into DivX video.

ABOUT DIVX VIDEO-ON-DEMAND: This DivX Certified® device must be registered in order to play DivX Video-on-Demand (VOD) content. To generate the registration code, locate the DivX VOD section in the device setup menu. Go to vod.divx.com with this code to complete the registration process and learn more about DivX VOD.

DivX® and DivX Ultra® are registered trademarks of DivX, Inc., and are used under license.

This apparatus includes these labels:



Class II equipment symbol



This symbol indicates that the apparatus has a double insulation system. Refer to the type plate at the back of the main unit and the bottom of the subwoofer for identification and supply ratings.

2 Your DVD Micro Theater

Congratulations on your purchase, and welcome to Philips! To fully benefit from the support that Philips offers, register your product at www.philips.com/welcome.

Introduction

With this unit, you can:

- watch video from DVD/VCD/SVCD/ DVD+RW or USB
- enjoy audio from discs or USB
- view pictures from discs or USB



You can enrich sound output with these sound effects:

- Digital Sound Control (DSC)
- Dynamic Bass Boost (DBB)
- Bass/treble enhancement
- Dolby Virtual Speakers (Dolby VS)

The unit supports these media/disc formats:



You can play DVD discs with the following region codes:

DVD region code	Countries
 	Latin America

What's in the box



Check and identify the contents of your package:

- Main unit
- Subwoofer
- Composite AV cable
- MP3 LINK cable
- Flat pin adaptor
- Wall mounting screws and dowels
- User Manual
- Quick Start Guide
- Wall mounting instruction sheet

Overview of the main unit

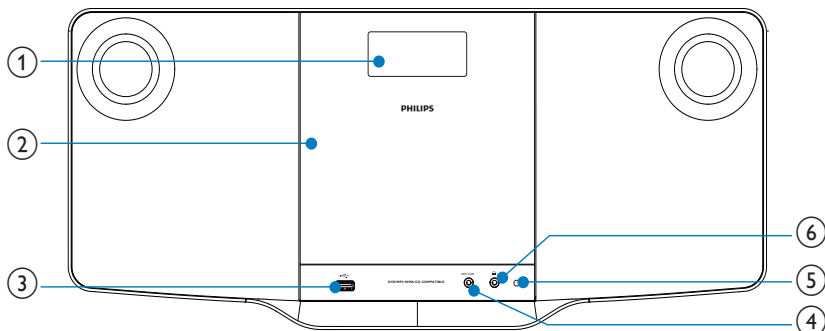
Front view



- ① **Display panel**
 - Display current status.
- ② **Disc compartment**
- ③  **USB socket.**
- ④ **MP3 LINK**
 - Jack for an external audio device.
- ⑤ **Remote control sensor**
- ⑥  **Headphone socket.**

Back view

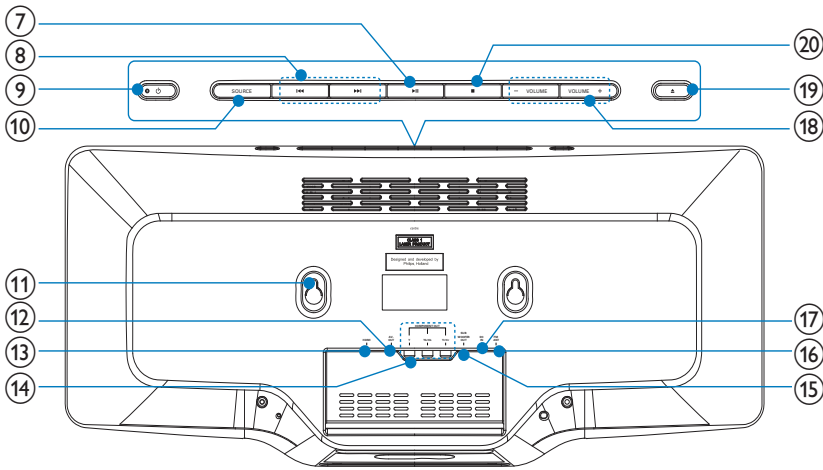

- ⑦ **▶||**
- Start or pause play.
- ⑧ **◀◀▶▶**
- Press and hold for fast backward or forward search.
 - Skips to the previous or next title, chapter or track.
- ⑨ **⏻**
- Turn on the apparatus; switch to standby mode.
- ⑩ **SOURCE**
- Select a source.
- ⑪ **Sockets for wall mounting**
- ⑫ **AV OUT**
- Socket for audio/video output.
- ⑬ **HDMI**
- HDMI output socket.
- ⑭ **COMPONENT OUT**
- Socket for component video output.
- ⑮ **SUBWOOFER OUT**
- Subwoofer out socket.
- ⑯ **FM ANT**
- FM antenna.
- ⑰ **DC IN**
- Power supply socket
- ⑱ **VOLUME +/-**
- Adjust volume.
- ⑲ **▲**
- Press to open or close the disc compartment.
- ⑳ **■**
- Stop play.
 - Erase a program.

Overview of the subwoofer

Bottom view

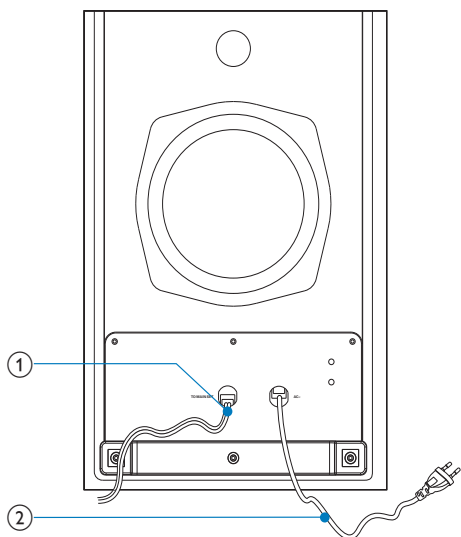

- ① Cable to the main set.
- ② Power cable.

Overview of the remote control

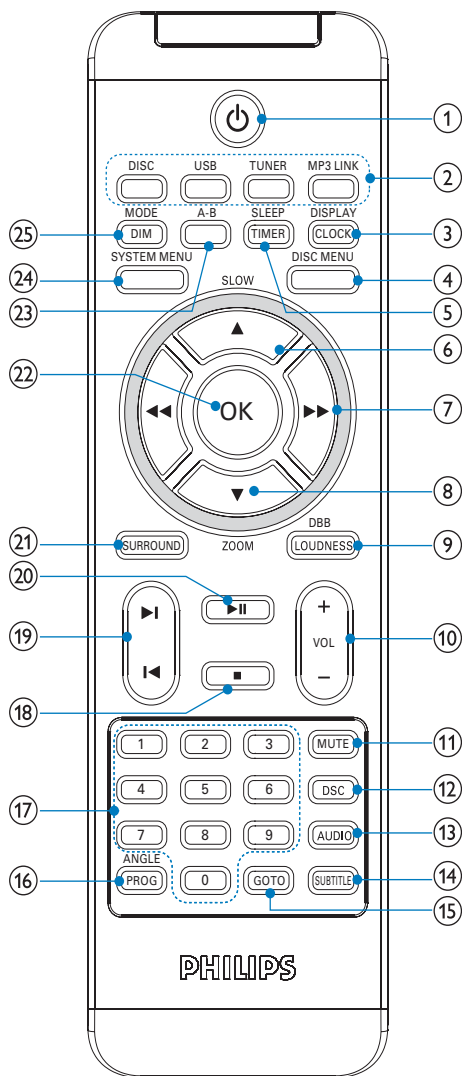

- ①
 - Turn on the apparatus; switch to standby mode.
- ② **Source selection keys**
 - Select a source.

- ③ DISPLAY/CLOCK**
- Display play information on a connected TV.
 - Set or display clock.
- ④ DISC MENU**
- For video discs: access or exit the disc menu.
 - For video discs with playback control(PBC): turn on/off PBC.
- ⑤ SLEEP/TIMER**
- Set the sleep timer.
 - Set the alarm timer.
- ⑥ ▲/SLOW**
- For menus: navigate up
 - Move an enlarged picture up
 - Rotate or invert pictures.
 - Select a slow play mode.
- ⑦ ◀◀/▶▶**
- Search within a track or disc.
 - For menus, navigate left/right.
 - Tune to a radio station.
 - Move an enlarged picture left/right.
 - Adjust time.
 - Toggle between 24H and 12H during clock setting.
- ⑧ ▼/ZOOM**
- For menus: navigate down.
 - Move an enlarged picture down.
 - Rotate or invert pictures.
 - Zoom in or out a picture/video image on the TV screen.
- ⑨ LOUDNESS/DBB**
- Turn on or off automatic loudness adjustment.
 - Turn on or off dynamic bass enhancement.
- ⑩ VOL +/-**
- Adjust volume.
- ⑪ MUTE**
- Mute or restore volume.
- ⑫ DSC**
- Select a preset sound setting.
- ⑬ AUDIO**
- For VCD, select stereo, mono-left or mono-right channel.
 - For DVD/DivX video, select an audio language.
- ⑭ SUBTITLE**
- Select a subtitle language.
- ⑮ GOTO**
- During disc play, specify a position to start play.
- ⑯ ANGLE/PROG**
- Select a DVD camera angle.
 - Program tracks.
 - Program titles/chapters for DVD play.
 - Program radio stations.
- ⑰ Numeric keypad**
- Select a title/chapter/track directly.
- ⑱ ■**
- Stop play.
 - Erase a program.
- ⑲ ◀▶**
- Skip to the previous/next track.
 - Skip to the previous/next title or chapter.
 - Select a preset radio station.
- ⑳ ▶||**
- Start or pause play.
- ㉑ SURROUND**
- Enable/disable Dolby Virtual Speakers (Dolby VS) sound effect.
- ㉒ OK**
- Confirm a selection.
- ㉓ A-B**
- Repeat a specific section within a track/disc.
- ㉔ SYSTEM MENU**
- Access or exit the system setup menu.
- ㉕ MODE/DIM**
- Select repeat play modes.
 - Select shuffle play modes.
 - Select a brightness level for the display screen.

3 Connect

Place the unit

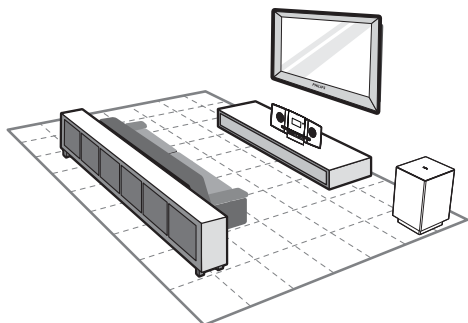

- 1 Place the unit near to the TV.
- 2 Place the subwoofer at the corner of the room or at least one meter away from the TV.
- 3 Place the main unit on a hard, flat and stable surface.

Tip

- You can also mount the unit on the wall with the supplied screws.

Note

- To avoid magnetic interference or unwanted noise, never place this apparatus and speakers too close to any radiation devices.
- Never place this unit in an enclosed cabinet.
- Install this unit near the AC outlet where the AC power plug can be easily reached.

Before you connect

- 1 Place a soft cloth on a hard, flat, stable surface.
- 2 With its front panel face-down, place the unit onto the cloth.

Connect TV

Connect video cables

With this connection, you can watch video from the unit on the TV screen.

You can select the best video connection that your TV supports.

- Option 1: Connect through HDMI (for a HDMI, DVI or HDCP-compliant TV).
- Option 2: connect through component video (for a standard TV or Progressive Scan TV).
- Option 3: connect through composite video (CVBS) (for a standard TV).

Option 1: Connect through HDMI

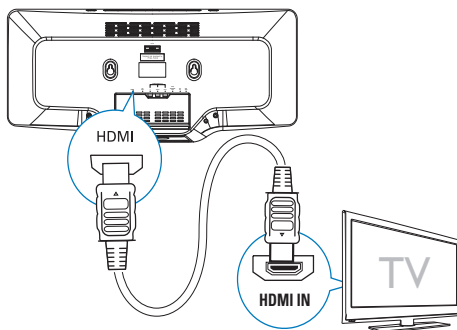

Connect HDMI (High Definition Multimedia Interface), DVI (Digital Visual Interface), or HDCP (High-bandwidth Digital Contents Protection)-compliant TVs through HDMI for the best picture quality. This connection transmits both video and audio signals. Through this connection, you can watch DVDs that contain HD (High-Definition) content.

Note

- Some TVs do not support HDMI audio transmission.
- This connection provides the best video quality.

- 1 Connect an HDMI cable (not supplied) to:

- the **HDMI** socket on this unit.
- the HDMI input socket on the TV.

Note

- If your TV has only a DVI connection, connect through a HDMI/DVI adaptor. An extra audio connection is needed to complete this connection.

Option 2: Connect through component video

Connect a progressive scan TV through component video for higher quality video.

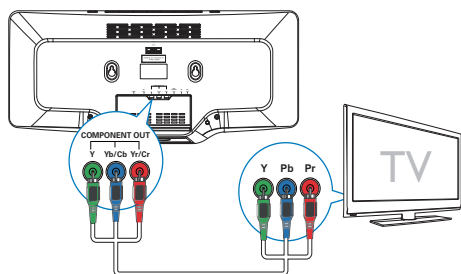

- 1 Connect component video cable (red/blue/green - not supplied) to:
 - the **COMPONENT OUT**(Y Pb/Cb Pr/Cr) sockets on this unit.
 - the component input sockets on the TV.

Option 3: Connect through composite video

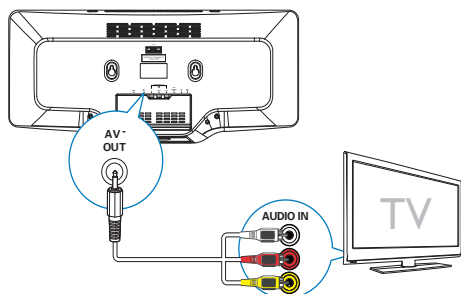

- 1 Connect the supplied composite video cable to:
 - the **AV OUT** socket on this unit.
 - the video input socket on the TV.

Connect Subwoofer

- 1 Insert the grey audio plug from the subwoofer into the **SUBWOOFER OUT** socket on the main unit.

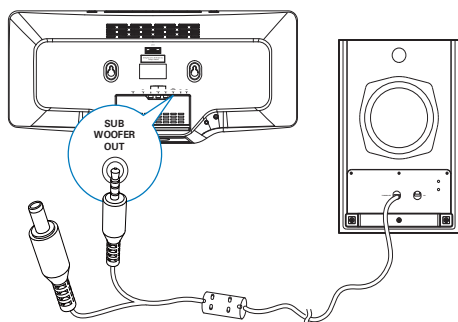

- 2 Connect another grey plug (DC input plug) from the subwoofer to the **DC IN** socket on the main unit.

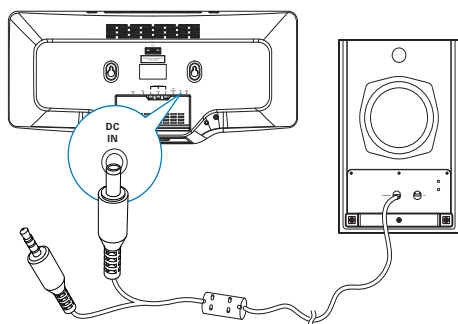

Connect power

! Caution

- Risk of product damage! Ensure that the power supply voltage corresponds to the voltage printed on the back or the underside of the unit.
- Risk of electric shock! When you unplug the AC power, always pull the plug from the socket. Never pull the cord.
- Before you connect the AC power, ensure you have completed all other connections.

- 1 Connect the power plug (black) on the subwoofer to the wall outlet.

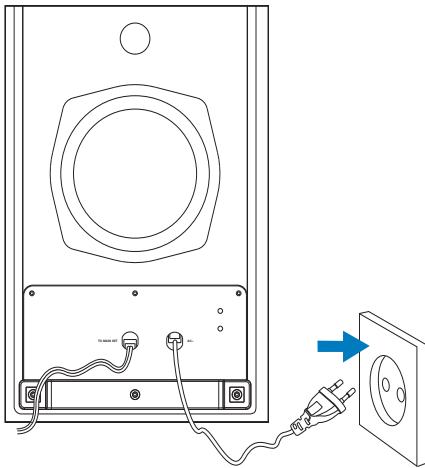

* Tip

- The AC voltage, frequency and current consumption information is located at rear of the main unit.

4 Get started



Caution

- Use of controls or adjustments or performance of procedures other than herein may result in hazardous radiation exposure or other unsafe operation.

Always follow the instructions in this chapter in sequence.

If you contact Philips, you will be asked for the model and serial number of this apparatus. The model number and serial number are on the back of the apparatus. Write the numbers here:

Model No. _____

Serial No. _____

Prepare the remote control



Caution

- Risk of explosion! Keep batteries away from heat, sunshine or fire. Never discard batteries in fire.

For first-time use:

- 1 Remove the protective tab to activate the remote control battery.
- 2 Open the battery compartment.
- 3 Insert one lithium CR2025 battery with correct polarity (+/-) as indicated.
- 4 Close the battery compartment.



Note

- Before you press any function button on the remote control, first select the correct source with the remote control instead of the main unit.

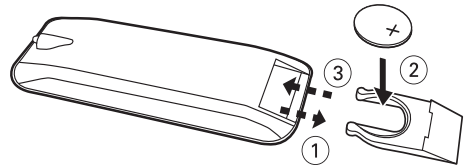
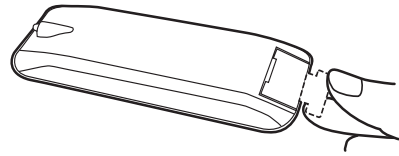

Set clock

- 1 In the standby mode, press and hold **CLOCK** on the remote control to activate the clock setting mode.
↳ 24H begin to blink.
- 2 Press **◀▶** repeatedly to toggle between 12H and 24H.
- 3 Press **CLOCK** to confirm.
↳ The hour digits displays and begin to blink.
- 4 Press **◀▶** to set the hour and press **CLOCK** to confirm.
↳ The minute digits displays and begin to blink.
- 5 Press **◀▶** to set the minute and press **CLOCK** to confirm.

Turn on

- 1 Press **⏻**.
↳ The unit switches to the last selected source.

Switch to standby mode

- 1 Press **⏻** again.
↳ The clock (if set) appears on the display panel.

Find the correct viewing channel

- 1 Press **⏻** to turn on the unit.
- 2 Press **DISC** to switch to disc mode.
- 3 Turn on the TV and switch to the correct video-in channel in one of the following ways:
 - Go to the lowest channel on your TV, then press the Channel Down button until you see the Philips screen.
 - Press the source button repeatedly on the remote control of your TV.



Tip

- The video-in channel is between the lowest and highest channels and may be called FRONT, A/V IN, VIDEO, HDMI etc. See the TV user manual on how to select the correct input on the TV.

Select the correct TV system

Change this setting if the video does not appear correctly. By default, this setting matches the most common setting for TVs in your country.

- 1 Press **SYSTEM MENU**.
- 2 Select **[Video Setup]**.
- 3 Select **[TV System]** and then press **▶▶**.
- 4 Select a setting and then press **OK**.
 - **[PAL]** - For TV with PAL color system.
 - **[Multi]** - For TV that is compatible with both PAL and NTSC.

- **[NTSC]** - For TV with NTSC color system.

- 5 To exit the menu, press **SYSTEM MENU**.



Note

- When the HDMI cable is connected, the **[TV System]** option is unavailable.

Change system menu language

- 1 Press **SYSTEM MENU**.
- 2 Select **[General Setup]**.
- 3 Select **[OSD Language]** and then press **▶▶**.
- 4 Select a setting and then press **OK**.
- 5 To exit the menu, press **SYSTEM MENU**.

Turn on Progressive Scan

Progressive scan displays twice the number of frames per seconds than interlaced scanning (ordinary TV system). With nearly double the number of lines, progressive scan offers higher picture resolution and quality.

Before you turn on this feature, ensure that:

- The TV supports progressive scan signals.
- You have connected this unit with the TV through component video.

- 1 Turn on the TV.
- 2 Ensure that the TV progressive scan mode is deactivated (see the TV user manual).
- 3 Switch the TV to the correct viewing channel for this unit.
- 4 Press **DISC**.
- 5 Press **SYSTEM MENU**.
- 6 Press **▼** to select **[Video Setup]** in the menu, then press **▶▶**.

- 7 Select [**Progressive**], then press ►►.
- 8 Select [**On**], then press **OK**.
↳ A warning message is displayed.
- 9 To proceed, select [**OK**] and press **OK**.
↳ The progressive setup is complete.

**Note**

- If a blank/distorted screen is displayed, wait for 15 seconds for auto recovery or turn off progressive scan manually.

- 10 Turn on the progressive scan mode on the TV.

5 Play

Note

- With some disc/file types, play may differ.

Play discs

Caution

- Never look at the laser beam inside the unit.
- Risk of product damage! Never play discs with accessories such as disc stabilizer rings or disc treatment sheets.
- Never put any objects other than discs into the disc compartment.

- 1 Press **DISC** to select the DISC source.
- 2 Insert a disc into the disc compartment and press **▲**.
 - Ensure that the label faces outwards.
- 3 Play starts automatically.
 - To stop play, press **■**.
 - To pause or resume play, press **▶||**.
 - To skip to the previous/next title/ chapter/track, press **◀|▶**.

If play does not start automatically:

- Select a title/chapter/track and then press **OK**.

Tip

- To play a locked DVD, enter the 6-digit parental control password.

Use the disc menu

When you load a DVD/(S)VCD disc, a menu may be displayed on the TV screen.

To access or exit the menu manually:

- 1 Press **DISC MENU**.

For VCD with PlayBack Control (PBC) feature (version 2.0 only):

With the PBC feature, you can play VCD interactively according to the menu screen.

- 1 During play, press **DISC MENU** to enable/disable PBC.
 - ↳ When PBC is enabled, the menu screen is displayed.
 - ↳ When PBC is disabled, normal play is resumed.

Select an audio language

You can select an audio language on DVDs, DiVx video or VCDs.

- 1 During disc play, press **AUDIO**.
 - ↳ The language options appear. If the selected audio channels is unavailable, the default disc audio channel is used.

Note

- For some DVDs, the language can only be changed from the disc menu. Press **DISC MENU** to access the menu.

Select a subtitle language

You can select a subtitle language on DVDs or DivX® Ultra discs.

- During play, press **SUBTITLE**.

Tip

- For some DVDs, the language can only be changed from the disc menu. Press **DISC MENU** to access the menu.

Play from USB

Note

- Ensure that the USB device contains playable music, pictures or video.

- 1 Insert the USB plug into the  socket.
- 2 Press **USB** to select the USB source.
- 3 Press **DISC MENU** until the folder is displayed.
- 4 Press **▲/▼** to select a folder, then press **OK** to confirm.
- 5 Press **▲/▼** to select a file from the folder.
- 6 Press **▶||** to start play.
 - To stop play, press **■**.
 - To pause or resume play, press **▶||**.
 - To skip to the previous/next file, press **◀▶**.

Play DivX video

You can play DivX files copied onto a CD-R/RW, recordable DVD, USB device.

- 1 Insert a disc or connect a USB device.
- 2 Select a source:
 - For discs, press **DISC**.
 - For USB devices, press **USB** repeatedly.
- 3 Select a file to play and press **OK**.
 - To stop play, press **■**.
 - To pause or resume play, press **▶||**.
 - To change a subtitle language, press **SUBTITLE**.

Note

- You can only play DivX videos rented or purchased through the DivX registration code of this unit.
- Subtitle files with the following filename extensions (.srt, .smi, .sub, .ssa, .ass) are supported but do not appear on the file navigation menu.
- The subtitle filename has to be the same as the file name of the video.

Play MP3/WMA/picture files

You can play MP3/WMA/picture files copied onto a CD-R/RW, recordable DVD or USB device.

- 1 Insert a disc or connect a USB device.
- 2 Select a source:
 - For discs, press **DISC**.
 - For USB devices, press **USB**.
- 3 Press **DISC MENU** until the folder is displayed.
- 4 Press **▲/▼** to select a folder, then press **OK** to confirm.
- 5 Press **▲/▼** to select a file from the folder.
- 6 Press **OK / ▶||** to start play.
 - To stop play, press **■**.
 - To pause or resume play, press **▶||**.
 - To skip to the previous/next file, press **◀▶**.

Play control

Select repeat/shuffle play options

- 1 During play, press **MODE/DIM** repeatedly to select a repeat option or the shuffle play mode.
 - To resume normal play, press **MODE/DIM** repeatedly until no option is displayed.

Repeat A-B (DVD/VCD/CD/MP3/WMA)

- 1 During music or video play, press **A-B** at the start point.
- 2 Press **A-B** at the end point.
 - ↳ The selected section starts to play repeatedly.
 - To cancel repeat play, press **A-B** again.



Note

- The section A and B can be set only within the same track/title.

Search forward/backward

- 1 During play, press ◀▶ repeatedly to select a search speed.
 - To resume play at normal speed, press ▶||.

Search by time or chapter/track number

- 1 During video/audio play, press **GOTO** repeatedly to display time field or track field.
 - For the time field, enter the play position in hours, minutes and seconds.
 - For the track field, enter the track/ chapter number.
 - Play starts automatically at your selected point.



Note

- The displayed fields may vary from source type.

Resume video play from last stopped point



Note

- This feature is only available for DVD/VCD/ CD play.

- 1 In stop mode and when the disc has not been removed, press ▶||.

To cancel resume mode and stop play completely:

- 1 In stop mode, press ■.

Play options

Display play information

- 1 During play, press **DISPLAY/CLOCK** repeatedly to show different play information or clock.

Program

For DVDs/VCDs/CDs:

- 1 In stop mode, press **ANGLE/PROG** to access the program menu.
- 2 Use the number keys to enter the tracks/ chapters into the program list.
- 3 Repeat step 2 until the program is complete.
- 4 Select [**Start**].
 - ↳ The programmed tracks/chapters start to play.



Note

- You cannot program picture files/discs, WMA, DixX or MP3 discs.

Zoom in/out image

- 1 During video/picture play, press and hold ▼/**ZOOM** to select zoom scale.
 - When the image is zoomed in, you can press ◀▶/▲/▼ to pan through the image.

Slow-motion play

- 1 During video play, press ▲/**SLOW** repeatedly to select a slow play mode.
 - ↳ The sound is muted.
 - ↳ To resume play at normal speed, press ▶||.

Select a camera angle



Note

- This feature is only available for DVDs recorded with multiple camera angles.

- 1 During play, press **ANGLE/PROG** repeatedly to select a camera angle.

Picture view options

Preview pictures

- 1 During play, press **■**.
↳ The thumbnails of 12 pictures are displayed.
- 2 Press **◀/▶** to turn to the next/previous page (if available)
- 3 Navigate through the current page with buttons **◀◀/▶▶,▲/▼** and select a picture.
- 4 Press **OK** to start slide show from the selected picture to the last one in this folder.

Select a slide show play mode

- 1 During play, press **ANGLE/PROG** repeatedly to select a slide-show play mode.

Rotate picture

- 1 During play,
 - Press **◀◀** to rotate counter-clockwise.
 - Press **▶▶** to rotate clockwise.
 - Press **▲** to flip up/down.
 - Press **▼** to flip left/right.

6 Adjust settings



Tip

- You can set or change the password, go to **[Preferences]** > **[Password]**.



Note

- If the setup option is grayed out, it means the setting cannot be changed at the current state.

General setup

- 1 Press **SYSTEM MENU**.
↳ **[General Setup]** menu is displayed.
- 2 Press **▶▶**.
- 3 Select an option, then press **OK**.
- 4 Select a setting, then press **OK**.
 - To return to the previous menu, press **◀◀**.
 - To exit the menu, press **SYSTEM MENU**.

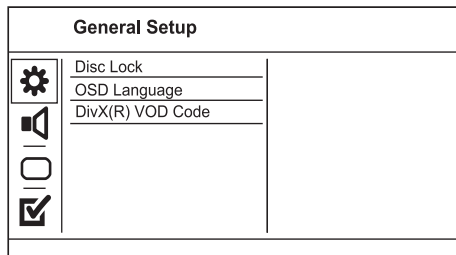

[Disc Lock]

Set play restriction for a disc which is loaded in the disc compartment (maximum 20 discs can be locked).

- **[On]** - Restrict access to the current disc. The next time you want to play this disc or unlock it, you need to enter the password.
- **[Off]** - Play all discs.

[OSD Language]

Select an on-screen menu language.

[DivX(R) VOD Code]

Display the DivX® registration code.



Tip

- Use this product's DivX registration code when you rent or purchase video from www.divx.com/vod. The DivX videos rented or purchased through the DivX® VOD (Video On Demand) service can be played only on the device to which it is registered.

Audio setup

- 1 Press **SYSTEM MENU**.
↳ **[General Setup]** menu is displayed.
- 2 Press **▼** to select **[Audio Setup]**, then press **▶▶**.
- 3 Select an option, then press **OK**.
- 4 Select a setting, then press **OK**.
 - To return to the previous menu, press **◀◀**.
 - To exit the menu, press **SYSTEM MENU**.

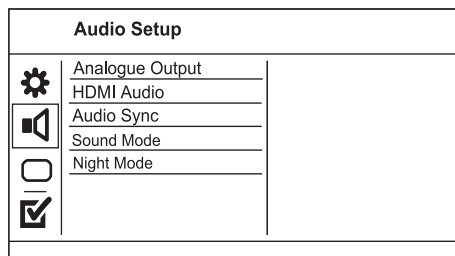

[Analogue Output]

Select an analogue setting based on the audio device that is connected through the analogue audio jack.

- **[LT/RT]** - For surround sound output through two speakers.
- **[Stereo]** - For stereo output.
- **[VS Wide]** - Dolby Virtual Speaker option for small space.
- **[VS Reference]** - Dolby Virtual Speaker option for spacious room.

[HDMI Audio]

Select the HDMI audio setting when you connect this product and the TV with an HDMI cable.

- **[On]** - Allow audio output through the TV and the speaker system. If the audio format on the disc is not supported, it will be downmixed to two-channel sound (linear-PCM).
- **[Off]** - Disable audio output from the TV. The sound is only output through the speaker system.

[Audio Sync]

Set the delay time for audio output when you play a video disc.

- 1 Press **OK**.
- 2 Press **◀▶▶** to set the delay time.
- 3 Press **OK** to confirm and exit.

[Sound Mode]

Selects a preset sound effect to enhance the audio output.

- **[3D]** – Set the 3D processing output mode.
- **[Movie Mode]** – Select a sound effect for movies.

[Night Mode]

Make loud sound level softer and soft sound level louder so that you can watch the DVD movies at a low volume, without disturbing others.

- **[On]** – Enjoy quiet viewing at night.





- **[Off]** – Enjoy surround sound with a full dynamic range.

Note

- Applicable only to Dolby Digital encoded DVD.

Video setup

- 1 Press **SYSTEM MENU**.
↳ **[General Setup]** menu is displayed.
- 2 Press **▼** to select **[Video Setup]**, then press **▶▶**.
- 3 Select an option, then press **OK**.
- 4 Select a setting, then press **OK**.
 - To return to the previous menu, press **◀◀**.
 - To exit the menu, press **SYSTEM MENU**.

Video Setup	
	TV System
	TV Display
	Progressive
	Picture Setting
	HD JPEG
	HDMI Setup

[TV System]

Change this setting if the video does not appear correctly. By default, this setting matches the most common setting for TVs in your country.

- **[PAL]** - For PAL-system TV.
- **[Multi]** - For TV that is compatible with both PAL and NTSC.
- **[NTSC]** - For NTSC-system TV.

[TV Display]

Select a display format:



4:3 Pan Scan (PS)



4:3 Letter Box (LB)



16:9 (Wide Screen)

- **[4:3 Pan Scan]** - For 4:3 screen TV: full-height display with the trimmed sides.
- **[4:3 Letter Box]** - For 4:3 screen TV: wide-screen display with black bars on the top and bottom of the screen.
- **[16:9]** - For wide-screen TV: display ratio 16:9.

[Progressive]

If a progressive scan TV is connected to this product, turn on the progressive scan mode.

- **[On]** - Turn on progressive scan.
- **[Off]** - Turn off progressive scan mode.

Note

- For more detailed description, see "Get started" > "Turn on progressive scan".

[Picture Setting]

Select a predefined set of picture color settings or customize the personal setting.

- **[Standard]** - Original color setting.
- **[Bright]** - Vibrant color setting.
- **[Soft]** - Warm color setting.
- **[Personal]** - Customize the color setting. Set the level of brightness, contrast, tint and color saturation, then press **OK**.

[HD JPEG]

Enjoy untouched and uncompressed JPEG pictures at its original resolution when you connect this product and the TV with an HDMI cable.

- **[On]** - Display high definition picture.
- **[Off]** - Display standard picture.

Note

- This product supports the resolution display of 720p and above.

[HDMI Setup]

When you connect this apparatus and TV with HDMI cable, select the best HDMI video setting that your TV supports.

- **[Wide Screen Format]** – Define the wide screen format for disc play.

Note

- This setting is only available if you have set the **[TV Display]** setting to **[16:9 Wide Screen]**.
- **[HDMI Video]** – Select the HDMI video output resolution that is compatible with your TV display capability.

Note

- If the setting is not compatible with your TV, a blank screen appears. Wait for 15 seconds for auto recover or switch to its default mode as follows: 1) Press **▲** 2) Press **◀** 3) Press **ZOOM**.
- **[EasyLink]** -- Set one-touch play and one-touch standby between EasyLink-compliant devices.





Note

- Compliant devices must be connected to the unit via HDMI.

Preferences

Note

- Stop disc play before you can access to **[Preferences]**.

Preferences	
	Audio
	Subtitle
	Disc Menu
	Parental Control
	PBC
	Mp3 / Jpeg Nav
	Password
	DivX Subtitle

- 1 Press **SYSTEM MENU**.
↳ [**General Setup**] menu is displayed.
- 2 Press ▼ to select [**Preferences**], then press ►►.
- 3 Select an option, then press **OK**.
- 4 Select a setting, then press **OK**.
 - To return to the previous menu, press ◀◀.
 - To exit the menu, press **SYSTEM MENU**.

[Audio]

Select an audio language for disc play.

[Subtitle]

Select a subtitle language for disc play.

[Disc Menu]

Select a disc menu language.

Note

- If the language you have set is not available on the disc, the disc uses its own default language.

[Parental control]

Restrict access to discs that are unsuitable for children. These types of discs must be recorded with ratings.

-
1. Press **OK**.
 2. Select a rating level, then press **OK**.
 3. Press the **numeric buttons** to enter the password.
-

Note

- Rated DVDs above the level you set in [**Parental control**] require a password to be played.
- The ratings are country-dependent. To allow all discs to play, select '8'.
- Some discs have ratings printed on them but are not recorded with ratings. This function has no effect on such discs.

[PBC]

Turn on or off the content menu of VCDs/SVCDs with PBC (playback control) feature.

- [**On**] - Display the index menu when you load a disc for play.
- [**Off**] - Skip the menu and start play from the first title.

[MP3/JPEG Nav]

Select to display the folders or display all the files.

- [**View Files**] - Display all the files.
- [**View Folders**] - Display the folders of MP3/WMA files.

[Password]

Set or change the password for locked discs and play restricted DVDs.

-
1. Press the **Numeric buttons** to enter default password '123456' or the last set password at [**Old Password**] field.
 2. Enter the new password at [**New Password**] field.
 3. Enter the new password again at [**Confirm PWD**] field.
 4. Press **OK** to exit the menu.
-

Note

- If you forget the password, enter '123456' before you set a new password.

[Divx Subtitle]

Select the language of the DivX.



- Ensure that the subtitle file has the exact same file name as the movie file. If for example the file name of the movie is 'Movie.avi', then you need to name the text file 'Movie.sub' or 'Movie.srt'.

[Default]

Reset all the settings of this product to factory default, except for **[Disc Lock]**, **[Parental control]** and **[Password]** settings.

7 Tune to FM radio stations

Note

- Ensure that you have connected and fully extended the supplied FM antenna.

Plug & Play

When you connect the unit to the power supply for the first time, or no radio station is stored in this unit, Plug and Play mode is activated to store all available radio stations automatically.

- 1 Connect the unit to the power supply.
 - ↳ [AUTO INSTALL - PRESS PLAY, STOP CANCEL] (auto install - press the PLAY button; to cancel, press ■) displays.
- 2 Press ►|| on the main unit to start installation.
 - ↳ [AUTO] (auto) displays.
 - ↳ [PROG] (program) flashes.
 - ↳ The unit automatically store radio stations with sufficient signal strength.
- 3 When all the available radio stations are stored, the first preset radio station is broadcast automatically.

Tip

- If no key is pressed during Plug and Play mode, the system goes to Standby mode after timeout of 5 times. To go to installation again, press and hold ►|| for 3 seconds under Standby mode.

Toexit Plug and Play installation mode

- 1 press source keys or ⏻ on the remote control.
 - ↳ The system switches to the designated source mode or standby mode.

Program radio stations automatically

Note

- You can program a maximum of 20 preset radio stations.

- 1 Press ◀▶ to select a preset number to start programing.
- 2 Press and hold **ANGLE/PROG** for 2 seconds to activate automatic programming.
 - ↳ [AUTO] (auto) is displayed briefly.
 - ↳ All available stations are programmed in the order of waveband reception strength.
 - ↳ The last programed radio station is broadcast automatically.

Program radio stations manually

Note

- You can program a maximum of 20 preset radio stations.

- 1 Tune to a radio station.
- 2 Press **ANGLE/PROG** to activate programming.
- 3 Press ◀▶ to allocate a number from 1 to 20 to this radio station, then press **ANGLE/PROG** to confirm.
 - ↳ The preset number and the frequency of the preset station are displayed.

- 4 Repeat the above steps to program other stations.



Note

- To overwrite a programmed station, store another station in its place.

Tune to a preset radio station

- 1 Press to select a preset number that you want.

8 Adjust volume level and sound effect

Adjust volume level

- 1 During play, press **VOL +/-** to increase/decrease the volume level.

Select a sound effect

Note

- You cannot use different sound effects at the same time.

Select a preset sound effect

- 1 During play, press **DSC** repeatedly to select:
 - **[POP]** (pop)
 - **[JAZZ]** (jazz)
 - **[ROCK]** (rock)
 - **[CLASSIC]** (classic)
 - **[FLAT]** (flat)

Enhance bass and automatic control loudness

Automatic loudness control increases the treble and bass effect at low volume levels (the higher the volume, the lower the treble and bass levels).

- 1 During play, press **LOUDNESS/DBB** repeatedly to toggle between the bass enhancement and loudness control.

Press	Display	Result
one time	DBB	Bass enhancement turned on
two times	LOUDNESS	Loudness control turned on, bass enhancement turned off.
three times	OFF	Both loudness control and bass enhancement turned off.

Select surround sound effect

Dolby VS (Dolby Virtual Speaker) technology creates a highly compelling 5.1-channel listening experience from as few as two speakers. It is an ideal entertainment solution for locations where space for multiple speaker setup is limited.

- 1 During play, press **SURROUND**.
 - ↳ The surround sound effect options display:
 - ↳ **[WIDE]** (Dolby virtual speaker wide): you will actually sense that the speakers are farther apart than they really are; it is great for small spaces.
 - ↳ **[REFERENCE]** (Dolby virtual speaker reference): the front sound image width is the same as the distance between the two speakers, so it is perfect if you have a more spacious environment.
 - ↳ **[OFF]** (off)

Note

- When the DVD disc playback, the Dolby VS turns on automatically. When the CD/MP3/WMA playback, the Dolby VS turns off automatically.

Mute sound

- 1 During play, press **MUTE** to mute/unmute sound.

Listen through headphone

- 1 Plug a headphone into the  socket on the unit.

9 Other features

Adjust brightness of display panel

- 1 In standby mode, press and hold **MODE/DIM** repeatedly to select different levels of brightness for the display panel.

Set the alarm timer

- 1 Ensure that you have set the clock correctly.
- 2 In standby mode, press and hold **SLEEP/TIMER**.
 - ↳ The hour digits are displayed and begin to blink.
- 3 Press **◀▶** to set the hour.
 - ↳ The minute digits are displayed and begin to blink.
- 4 Press **◀▶** to set the minute.
- 5 Press **DISC**, **TUNER** or **USB** to set the source of alarm sound.
- 6 Press **SLEEP/TIMER** to confirm.
 - ↳ A clock icon appears on the display.

- To activate/deactivate the wake-up timer, press **SLEEP/TIMER** to toggle between:
 - **[TIMER ON]** (timer on)
 - A clock icon appears on the display.
 - The unit turns on automatically at the set time and switches to the set source.
 - **[TIMER OFF]** (timer off)
 - Clock icon disappears on the display.



Note

- Alarm timer is not available under MP3 LINK mode.
- If DISC/USB source is selected and the track cannot be played, tuner is activated automatically.

Set the sleep timer

- 1 When the unit is turned on, press **SLEEP/TIMER** repeatedly to select a set period of time (in minutes).
 - ↳ The unit turns off automatically after the set period of time.

Connect other devices

Listen to an audio player

You can listen to audio player through this unit.

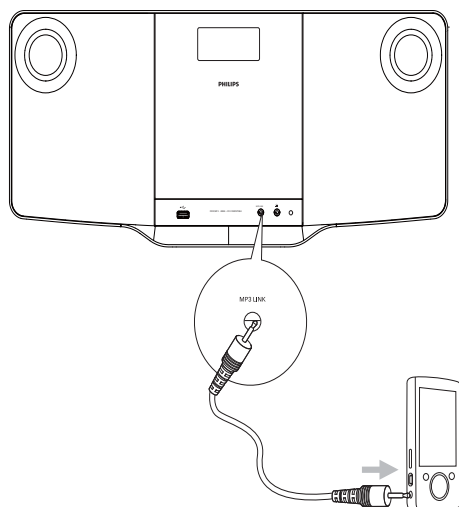

- 1 Connect the supplied 3.5mm audio cable to the **MP3 LINK** socket and to the headphone socket on the audio player.
- 2 Select the MP3 Link source.
- 3 Start play on the audio player.

10 Product information

Note

- Product information is subject to change without prior notice.

Specifications

Amplifier

Rated Output Power	2X10W + 40W RMS
Frequency Response	40 -20000 Hz, -3dB
Signal to Noise Ratio	>67dB
Aux Input	0.5V RMS 20k ohm

Disc

Laser Type	Semiconductor
Disc Diameter	12cm/8cm
Video Decoding	MPEG-1 / MPEG-2 / DivX
Video DAC	12Bits
Signal System	PAL / NTSC
Video Format	4:3 / 16:9
Video S/N	>48dB
Audio DAC	24Bits / 96kHz
Total Harmonic Distortion	<1%
Frequency Response	40Hz - 20kHz (44.1kHz) 40Hz - 22kHz (48kHz) 40Hz - 24kHz (96kHz)
S/N Ratio	>67dBA

Tuner (FM)

Tuning Range	87.5 - 108MHz
Tuning grid	50KHz
Sensitivity	- Mono, 26dB S/N Ratio <22 dBf - Stereo, 46dB S/N Ratio <43 dBf
Search Selectivity	>28dBf
Total Harmonic Distortion	<2%
Signal to Noise Ratio	>55dB

Speakers

Speaker	8ohm
Impedance	
Speaker Driver	3" Full range +5.25"subwoofer
Sensitivity	>82dB/m/W

General information

AC Power	110 - 240V~, 50/60 Hz
Operation Power Consumption	Main unit: 22W; Subwoofer: 45W
Standby Power Consumption	<4W
Composite Video Output	1.0Vp-p, 75ohm
Headphone Output	2X15mW 32ohm
USB Direct	Version 2.0
Dimensions	- Main Unit 525 x 90 x 200mm (W x H x D) - Active Subwoofer Box (W x H x D) 600 x 400 x 308 mm
Weight	- With Packing 8.8 kg - Main Unit 2.62 kg - Active Subwoofer Box 3.03 kg

Supported disc formats

- Digital Video Discs (DVDs)
- Video CDs (VCDs)
- Super Video CDs (SVCDs)
- Digital Video Discs + Rewritable (DVD+RW)
- Compact Discs (CDs)
- Picture (Kodak, JPEG) files on CDR(W)
- DivX(R) disc on CD-R(W):
- DivX 3.11, 4.x and 5.x
- DivX Ultra disc
- WMA

Supported MP3-CD formats:

- ISO 9660
- Max. title/album name: 12 characters
- Max. title number plus album: 255.
- Max. nested directory: 8 levels.
- Max. album number: 32.
- Max. MP3 track number: 999.
- Supported sampling frequencies for MP3 disc: 32 kHz, 44.1 kHz, 48 kHz.
- Supported Bit-rates of MP3 disc are: 32, 64, 96, 128, 192, 256 (kbps).
- The following formats are not supported:
 - Files like *.VMA, *.AAC, *.DLF, *.M3U,
 - *.PLS, *.WAV
 - Non-English Album/Title name
 - Discs recorded in Joliet format
 - MP3 Pro and MP3 with ID3 tag

USB playability information

Compatible USB devices:

- USB flash memory (USB 2.0 or USB1.1)
- USB flash players (USB 2.0 or USB1.1)
- memory cards (requires an additional card reader to work with this apparatus)

Supported formats:

- USB or memory file format FAT12, FAT16, FAT32 (sector size: 512 bytes)
- MP3 bit rate (data rate): 32-320 Kbps and variable bit rate
- WMA v9 or earlier
- Directory nesting up to a maximum of 8 levels
- Number of albums/ folders: maximum 99
- Number of tracks/titles: maximum 999
- ID3 tag v2.0 or later
- File name in Unicode UTF8 (maximum length: 128 bytes)

Unsupported formats:

- Empty albums: an empty album is an album that does not contain MP3/WMA files, and is not be shown in the display.
- Unsupported file formats are skipped. For example, Word documents (.doc) or MP3 files with extension .dlf are ignored and not played.
- AAC, WAV, PCM audio files
- DRM protected WMA files (.wav, .m4a, .m4p, .mp4, .aac)
- WMA files in Lossless format

11 Troubleshooting



Note

- Never remove the casing of this system.

To keep the warranty valid, never try to repair the system yourself.

If you encounter problems when using this system, check the following points before requesting service. If the problem remains unsolved, go to the Philips web site (www.Philips.com/support). When you contact Philips, ensure that your Philips is nearby and the model number and serial number are available.

No power

- Ensure that the AC cord of the apparatus is connected properly.
- Ensure that there is power at the AC outlet.
- As a power-saving feature, the system switches off automatically 15 minutes after track play reaches the end and no control is operated.

No disc detected

- Insert a disc.
- Check if the disc is inserted upside down.
- Wait until the moisture condensation at the lens has cleared.
- Replace or clean the disc.
- Use a finalized CD or correct format disc.

No picture

- Check the video connection.
- Turn on the TV to the correct Video-In channel.
- Progressive scan is activated but the TV does not support progressive scan.

Black and white or distorted picture

- The disc does not match the TV color system standard (PAL/NTSC).
- Sometimes a slight picture distortion may appear. This is not a malfunction.
- Clean the disc.
- A distorted picture may appear during progressive scan setup.

The aspect ratio of the TV screen cannot be changed even though you have set the TV display format.

- The aspect ratio is fixed on the loaded DVD disc.
- The aspect ratio may not be changed for some TV systems.

No sound or poor sound

- Adjust the volume.
- Disconnect the headphone.
- Ensure the wireless subwoofer is connected.

Remote control does not work

- Before you press any function button, first select the correct source with the remote control instead of the main unit.
- Reduce the distance between the remote control and the unit.
- Insert the battery with its polarities (+/- signs) aligned as indicated.
- Replace the battery.
- Aim the remote control directly at the sensor on the front of the unit.

Disc does not play

- Insert a readable disc and ensure that the label side faces outwards.
- Check the disc type, color system and regional code. Check for any scratches or smudges on the disc.
- Press **SYSTEM MENU** to exit the system setup menu.
- Disable the password for parental control or change the rating level.

- Moisture has condensed inside the system. Remove the disc and leave the system turned on for about an hour. Disconnect and reconnect the AC power plug, and then turn on the system again.
- As a power-saving feature, the system turns off automatically 15 minutes after disc play reaches the end and no control is operated.

Poor radio reception

- Increase the distance between the unit and your TV or VCR.
- Fully extend the FM antenna.
- Connect an outdoor FM antenna instead.

Unable to select Progressive Scan

- Ensure the video output mode is set to [Pr/Cr Pb/Cb Y].

No sound on HDMI connection.

- You may not hear any sound if the connected device is non-HDCP compliant or only DVI-compatible.

No picture on HDMI connection.

- Check if the HDMI cable is faulty. Replace a new HDMI cable.
- If this happens when you change the HDMI video resolution, select the correct resolution until the picture appears.

Audio or subtitle languages cannot be set

- The disc is not recorded with sound or subtitles in multiple languages.
- The audio or subtitle language setting is prohibited on the disc.

Cannot display some files in USB device

- The number of folders or files in the USB device has exceeded a certain limit. This phenomenon is not a malfunction.
- The formats of these files are not supported.

USB device not supported

- The USB device is incompatible with the unit. Try another one.

Timer does not work

- Set the clock correctly.
- Switch on the timer.

Clock/timer setting erased

- Power has been interrupted or the power cord has been disconnected.
- Reset the clock/timer.

12 Appendix

Mount to a wall

Caution

- Risk of product damage! Always consult professional personnel to safely mount the product to a wall.
- Risk of injury! Ensure that no supply ducts such as gas, water or electricity are harmed when you drill the holes.

What you'll need

- 2 screws and 2 dowels (supplied)
- Wall mounting instruction sheet (supplied)
- Electric drill
- Screwdriver
- Pencil

Mount the main unit

Caution

- Mount the main unit and speakers to a solid concrete wall or plaster board wall only!

You can mount the main unit to the wall.

- 1** Use the supplied wall mounting instruction sheet to mark the drilling positions on the wall, then drill 2 holes as marked.
- 2** Crew on the mounting dowels and screws.
- 3** Hook the main unit in place.

Tip

- Refer to the supplied wall mounting instruction sheet for details.

